

# OPERATION MANUAL

## MODEL KB-5121K

Followed by indicating color: K = black, W = white, S = stainless steel



<b>CONTENTS</b> .....	<b>2</b>	<b>INTRODUCTION TO TOUCHSCREEN</b> .....	<b>10</b>
<b>CUSTOMER ASSISTANCE</b> .....	<b>3</b>	<b>BEFORE OPERATING</b> .....	<b>10-11</b>
<b>PRECAUTIONS TO AVOID POSSIBLE EXPOSURE TO EXCESSIVE MICROWAVE ENERGY</b> .....	<b>3</b>	<b>COOKTOP USE</b> .....	<b>12-13</b>
<b>CONSUMER LIMITED WARRANTY</b> .....	<b>4</b>	<b>MICROWAVE DRAWER™ COOKING</b> .....	<b>14-26</b>
<b>IMPORTANT SAFETY INSTRUCTIONS</b> .....	<b>5-7</b>	<b>OTHER FEATURES</b> .....	<b>27-28</b>
<b>UNPACKING AND EXAMINING YOUR COOKTOP+MICROWAVE DRAWER</b> .....	<b>7</b>	<b>CLEANING AND CARE</b> .....	<b>29-30</b>
<b>PARTS NAME</b> .....	<b>8-9</b>	<b>BEFORE YOU CALL FOR SERVICE</b> .....	<b>31</b>
		<b>AUTO-TOUCH GUIDE</b> .....	<b>BACK COVER</b>

# CONTENTS

<b>CONTENTS</b> .....	<b>2</b>	<b>MICROWAVE DRAWER COOKING</b> .....	<b>14-26</b>
<b>CUSTOMER ASSISTANCE</b> .....	<b>3</b>	INFORMATION YOU NEED TO KNOW .....	14-15
<b>PRECAUTIONS TO AVOID POSSIBLE EXPOSURE TO EXCESSIVE MICROWAVE ENERGY</b> .....	<b>3</b>	MANUAL OPERATION .....	16
<b>CONSUMER LIMITED WARRANTY</b> .....	<b>4</b>	TIME COOKING.....	16
<b>PRODUCT INFORMATION CARD</b> .....	<b>4</b>	TO SET POWER LEVEL.....	16-17
<b>IMPORTANT SAFETY INSTRUCTIONS</b> .....	<b>5-7</b>	SENSOR SETTINGS.....	18-23
IMPORTANT SAFETY NOTICE AND WARNING .....	5	REHEAT.....	18-19
SAFETY PRECAUTIONS .....	5	POPCORN .....	19
RADIANT SURFACE UNITS.....	5-6	AUTOMATIC COOKING .....	20-23
MICROWAVE DRAWER™ .....	6-7	DEFROST .....	24
<b>UNPACKING AND EXAMINING YOUR COOKTOP+MICROWAVE DRAWER</b> .....	<b>7</b>	MANUAL DEFROST.....	24
<b>PARTS NAME</b> .....	<b>8-9</b>	OTHER CONVENIENT FEATURES .....	25-26
ELECTRIC COOKTOP+MICROWAVE DRAWER.....	8	KEEP WARM.....	25
GLASS CERAMIC COOKTOP, CONTROL PANEL AND KEYSHEET .....	9	MINUTE PLUS™ .....	25
<b>INTRODUCTION TO TOUCHSCREEN</b> .....	<b>10</b>	CUSTOM HELP® .....	25
<b>BEFORE OPERATING</b> .....	<b>10-11</b>	MORE / LESS TIME ADJUSTMENT .....	26
TO SET DATE AND TIME .....	11	<b>OTHER FEATURES</b> .....	<b>27-28</b>
STOP/CLEAR .....	11	KITCHEN TIMER .....	27
OPEN OR CLOSE MICROWAVE DRAWER .....	11	CONTROL LOCK .....	27
<b>COOKTOP USE</b> .....	<b>12-13</b>	SETUP.....	27-28
INFORMATION YOU NEED TO KNOW.....	12	PAGE FORWARD AND BACKWARD.....	28
RADIANT SURFACE UNITS.....	13	<b>CLEANING AND CARE</b> .....	<b>29-30</b>
SUGGESTED HEAT SETTINGS.....	13	NON-COOKTOP SURFACES .....	29
COOKTOP WARM ZONE .....	13	COOKTOP .....	29-30
		MICROWAVE DRAWER.....	30
		<b>BEFORE YOU CALL FOR SERVICE</b> .....	<b>31</b>
		<b>AUTO-TOUCH GUIDE</b> .....	<b>BACK COVER</b>

## CUSTOMER ASSISTANCE

To aid in reporting this electric Cooktop+Microwave Drawer, please record below the model number and serial number located on the unit. We also suggest you record all the information listed and retain for future reference.

MODEL NUMBER \_\_\_\_\_ SERIAL NUMBER \_\_\_\_\_

DATE OF PURCHASE \_\_\_\_\_ / \_\_\_\_\_ / \_\_\_\_\_

DEALER \_\_\_\_\_ TELEPHONE \_\_\_\_\_

SERVICER \_\_\_\_\_ TELEPHONE \_\_\_\_\_

### TO PHONE:

DIAL **1-800-BE-SHARP (237-4277)** for:  
SERVICE (for your nearest Sharp Authorized Servicer)  
PARTS (for your authorized parts distributor)  
ADDITIONAL CUSTOMER INFORMATION

### TO WRITE:

Sharp Electronics Corporation  
Customer Assistance Center  
1300 Naperville Drive  
Romeoville, IL 60446-1091

Please provide the following information when you write or call: model number, serial number, date of purchase, your complete mailing address (including zip code), your daytime telephone number (including area code) and description of the problem.

**TO ACCESS INTERNET:** [www.sharppusa.com](http://www.sharppusa.com)

## PRECAUTIONS TO AVOID POSSIBLE EXPOSURE TO EXCESSIVE MICROWAVE ENERGY

- (a)** Do not attempt to operate this oven with the door open since open-door operation can result in harmful exposure to microwave energy. It is important not to defeat or tamper with the safety interlocks.
- (b)** Do not place any object between the oven front face and the door or allow soil or cleaner residue to accumulate on sealing surfaces.
- (c)** Do not operate the oven if it is damaged. It is particularly important that the oven door close properly and that there is no damage to the: (1) door (bent), (2) hinges and latches (broken or loosened), (3) door seals and sealing surfaces.
- (d)** The oven should not be adjusted or repaired by anyone except properly qualified service personnel.

These precautions apply to the Microwave Drawer only.

## CONSUMER LIMITED WARRANTY

---

SHARP ELECTRONICS CORPORATION warrants to the first consumer purchaser that this Sharp brand product (the “Product”), when shipped in its original container, will be free from defective workmanship and materials, and agrees that it will, at its option, either repair the defect or replace the defective Product or part thereof with a new or remanufactured equivalent at no charge to the purchaser for parts or labor for the period(s) set forth below.

This warranty does not apply to any appearance items of the Product nor to the additional excluded item(s) set forth below nor to any Product the exterior of which has been damaged or defaced, which has been subjected to misuse, abnormal service or handling, or which has been altered or modified in design or construction.

In order to enforce the rights under this limited warranty, the purchaser should follow the steps set forth below and provide proof of purchase to the servicer.

The limited warranty described herein is in addition to whatever implied warranties may be granted to purchasers by law. ALL IMPLIED WARRANTIES INCLUDING THE WARRANTIES OF MERCHANTABILITY AND FITNESS FOR USE ARE LIMITED TO THE PERIOD(S) FROM THE DATE OF PURCHASE SET FORTH BELOW. Some states do not allow limitations on how long an implied warranty lasts, so the above limitation may not apply to you.

Neither the sales personnel of the seller nor any other person is authorized to make any warranties other than those described herein, or to extend the duration of any warranties beyond the time period described herein on behalf of Sharp.

The warranties described herein shall be the sole and exclusive warranties granted by Sharp and shall be the sole and exclusive remedy available to the purchaser. Correction of defects, in the manner and for the period of time described herein, shall constitute complete fulfillment of all liabilities and responsibilities of Sharp to the purchaser with respect to the Product, and shall constitute full satisfaction of all claims, whether based on contract, negligence, strict liability or otherwise. In no event shall Sharp be liable, or in any way responsible, for any damages or defects in the Product which were caused by repairs or attempted repairs performed by anyone other than an authorized servicer. Nor shall Sharp be liable or in any way responsible for any incident or consequential economic or property damage. Some states do not allow the exclusion of incidental or consequential damages, so the above exclusion may not apply to you.

THIS WARRANTY GIVES YOU SPECIFIC LEGAL RIGHTS. YOU MAY ALSO HAVE OTHER RIGHTS WHICH VARY FROM STATE TO STATE.

<b>Your product model number &amp; description</b>	KB-5121K Home Use Electric Cooktop+Microwave Drawer. (Be sure to have this information available when you need service for your Product.)
<b>Warranty period for this product:</b>	One (1) year parts and labor including in-home service. The warranty period continues for an additional four (4) years, for a total of five (5) years, with respect to the glass ceramic cooktop, radiant surface units and magnetron tube in the Product for parts only; labor and service are not provided free of charge for this additional period.
<b>Additional item(s) excluded from warranty coverage (if any):</b>	Non-functional accessories and light bulb.
<b>Where to obtain service:</b>	From a Sharp Authorized Servicer located in the United States. To find the location of the nearest Sharp Authorized Servicer, call Sharp toll free at 1-800-BE-SHARP (1-800-237-4277).
<b>What to do to obtain service:</b>	In-home service is provided for one year from date of purchase. In-home service can be arranged by calling 1-800-BE-SHARP. Be sure to have Proof of Purchase available.

---

TO OBTAIN SUPPLY, ACCESSORY OR PRODUCT INFORMATION, CALL 1-800-BE-SHARP OR VISIT [www.sharpsusa.com](http://www.sharpsusa.com). SAVE THE PROOF OF PURCHASE AS IT IS NEEDED SHOULD YOUR COOKTOP+MICROWAVE DRAWER EVER REQUIRE WARRANTY SERVICE.

## PRODUCT INFORMATION CARD

---

The Product Information Card should be completed within ten days of purchase and returned. We will keep it on file and help you access the information if needed. This will also enable us to contact you in the unlikely event that any adjustments or modifications are ever required for your Cooktop+Microwave Drawer.

# IMPORTANT SAFETY INSTRUCTIONS

READ ALL INSTRUCTIONS BEFORE USING

## IMPORTANT SAFETY NOTICE AND WARNING



**WARNING ANTI-TIP DEVICE** *To reduce the risk of tipping of this appliance from abnormal usage by excessive loading of the Microwave Drawer, the appliance must be secured by installing the Anti-Tip device supplied. If it is not, there is a possible risk of the product tipping and causing injury if you or a child stand, sit or lean on the open drawer. Please refer to the Anti-Tip device information in the Installation Manual.*



*To check if the device is installed and engaged properly, open the Microwave Drawer fully and gently apply medium force in the center of the handle until movement of the appliance is detected. Continue pressing until the Anti-Tip bracket is engaged and movement stops. A small amount of movement is acceptable at the back of the appliance top, but it should be stable and not tip once the Anti-tip bracket is engaged. Stop pressing on the Microwave Drawer handle and close.*

*To check that the unit will not slide out, open the Microwave Drawer fully and then apply gentle outward pressure. The unit should not slide toward you. If it does, refer to the Installation Instructions.*

## SAFETY PRECAUTIONS

When using electrical appliances, basic safety precautions should be followed, including the following:

- 1 Use this appliance only for its intended purpose as described in this manual.
- 2 Be sure your appliance is properly installed and grounded by a qualified technician in accordance with the provided installation instructions.
- 3 Never use appliance for warming or heating the room.
- 4 Children should not be left alone or unattended in area where appliance is in use. They should never be allowed to sit or stand on any part of the appliance.
- 5 Never wear loose-fitting or hanging garments while using the appliance. Be careful when reaching for items stored over the Cooktop. Flammable material could be ignited if brought in contact with hot surface units and may cause severe burns.
- 6 Do not repair or replace any part of appliance unless specifically recommended in this manual. All other servicing should be referred to a qualified technician.
- 7 Do not store flammable materials in the Microwave Drawer or near surface units. Do not store or use combustible materials, gasoline or other flammable vapors and liquids in the vicinity of this appliance.
- 8 Do not use water on grease fires. Smother a flame or use a dry chemical or foam-type extinguisher. Flaming grease outside a pan can be put out by covering it with

baking soda or, if available, by a multi-purpose dry chemical or foam-type fire extinguisher.

- 9 Use only dry potholders - a moist or damp potholder on hot surfaces may result in burns from steam. Do not let potholders touch hot surfaces or radiant surface units. Do not use a towel or other bulky cloth.
- 10 **CAUTION** Do not store items of interest to children in cabinets above a Cooktop+Microwave Drawer. Children climbing on the Cooktop+Microwave Drawer to reach items could be seriously injured.
- 11 Do not touch the surface units. These surfaces may be hot even though they are dark in color. These surfaces may become hot enough to cause burns. During and after use, do not touch or let clothing or other flammable materials contact surface units until they have had sufficient time to cool. Other potentially hot surfaces include: cooktop and areas facing the cooktop.
- 12 Have the installer show you the location of the circuit breaker or fuse. Mark it for easy reference.
- 13 Before performing any service, disconnect the Cooktop+Microwave Drawer power supply at the household distribution panel by removing the fuse or switching off the circuit breaker.
- 14 Do not allow anyone to climb, stand or hang on Microwave Drawer or cooktop. They could damage the Cooktop+Microwave Drawer and even tip it over, causing severe personal injury.
- 15 Teach children not to play with the controls or any other part of the Cooktop+Microwave Drawer.
- 16 Always keep wooden and plastic utensils and canned food a safe distance from your Cooktop+Microwave Drawer.
- 17 Always keep combustible wall coverings, curtains or drapes a safe distance from your Cooktop+Microwave Drawer.

## RADIANT SURFACE UNITS

- 1 Use proper pan size — this appliance has different size surface units. Select utensils having flat bottoms large enough to cover the surface unit heating element. The use of undersized utensils will expose a portion of surface unit heating element to direct contact and may result in ignition of clothing. Proper relationship of utensils to heating element will also improve efficiency.
- 2 Never leave surface units unattended at high heat settings. Boilovers cause smoking and greasy spillovers that may catch on fire.
- 3 Only certain types of glass, glass/ceramic, ceramic, earthenware or other glazed utensils are suitable for cooktop service without breaking due to the sudden change in temperature.

# IMPORTANT SAFETY INSTRUCTIONS

- 4 To reduce the risk of burns, ignition of flammable materials and spillage due to unintentional contact with utensils, the handle of a utensil should be positioned so that it is turned inward and does not extend over adjacent surface units.
- 5 Do not cook on broken cooktop. If cooktop should break, cleaning solutions and spillovers may penetrate the broken cooktop and create a risk of electric shock. Contact a qualified technician immediately.
- 6 Clean cooktop with caution. If a wet sponge or cloth is used to wipe spills on a hot surface unit, be careful to avoid steam burn. Some cleaners can produce noxious fumes if applied to a hot surface. Please see cleaning the glass cooktop section.
- 7 Clean ventilating hoods frequently. Grease should not be allowed to accumulate on hood or filter.
- 8 When flaming foods under the hood, turn the fan on.
- 9 Deep fat fryers - use extreme caution when moving the grease kettle or disposing of hot grease.
- 10 Always turn the surface units off before removing cookware.
- 11 Keep an eye on foods being fried at high or medium high heat settings.
- 12 Food for frying should be as dry as possible. Frost on frozen foods or moisture on fresh foods can cause hot fat to bubble up and over the sides of the pan.
- 13 Use little fat for effective shallow or deep fat frying. Filling the pan too full of fat can cause spillovers when food is added.  
If a combination of oils or fats will be used in frying, stir together slowly before heating or as fats melt.
- 14 Always heat fat slowly and watch as it heats.
- 15 Use a deep fat thermometer whenever possible to prevent heating fat beyond the smoking point.
- 16 Avoid scratching the glass cooktop. The cooktop can be scratched with items such as sharp instruments, rings or other jewelry and rivets on clothing.
- 17 Large scratches or impacts to glass door or cooktop can lead to broken or shattered glass.
- 18 Never use the glass cooktop surface as cutting board.
- 19 Do not place or store items that can melt or catch fire on the glass cooktop, even when it is not being used.
- 20 Be careful when placing spoons or other stirring utensils on glass cooktop surface when it is in use. They may become hot and could cause burns.

## MICROWAVE DRAWER

When using the Microwave Drawer, basic safety precautions should be followed, including the following:

**WARNING** *To reduce the risk of burns, electric shock, fire, injury to persons or exposure to excessive microwave energy:*

- 1 Read all instructions before using the appliance.
- 2 Read and follow the specific “PRECAUTIONS TO AVOID POSSIBLE EXPOSURE TO EXCESSIVE MICROWAVE ENERGY” on page 3.
- 3 This appliance must be properly grounded. See Installation Instructions for grounding instructions.
- 4 Install or locate this appliance only in accordance with the provided Installation Manual.
- 5 Some products such as whole eggs and sealed containers - for example, closed glass jars — are able to explode and should not be heated in the Microwave Drawer.
- 6 Use this appliance only for its intended use as described in this manual. Do not use corrosive chemicals or vapors in this appliance. This Microwave Drawer is specifically designed to heat, cook or dry food. It is not designed for industrial or laboratory use.
- 7 As with any appliance, close supervision is necessary when used by children.
- 8 Do not operate this appliance if it has a damaged cord, if it is not working properly or if it has been damaged or dropped.
- 9 This appliance should be serviced only by qualified service personnel. Contact nearest Sharp Authorized Servicer for examination, repair or adjustment.
- 10 Do not cover or block any openings on the appliance.
- 11 Do not store or use this appliance outdoors. Do not use this product near water — for example, in a wet basement, near a swimming pool or similar locations.
- 12 Do not immerse cord in water. Keep cord away from heated surfaces.
- 13 Do not climb or sit on the Microwave Drawer. The Cooktop+Microwave Drawer could tip and cause injuries to persons.
- 14 Be sure that fingers or other objects or materials are not around the Microwave Drawer opening when the Microwave Drawer is closed.
- 15 Do not put fingers or clothes around the drawer guides when the Microwave Drawer is opened or closed. They could be caught in the guides when the Microwave Drawer is closed.
- 16 Be sure that the food and container are shorter than the Microwave Drawer before closing it. You can refer to the height of the side walls of the Microwave Drawer.
- 17 When cleaning Microwave Drawer sealing surfaces that come together on closing the drawer, use only mild, nonabrasive soaps or detergents applied with a sponge or soft cloth. See cleaning instructions on page 30.

# IMPORTANT SAFETY INSTRUCTIONS

- 18** To reduce the risk of fire in the Microwave Drawer cavity:
- a** Do not overcook food. Carefully attend appliance when paper, plastic or other combustible materials are placed inside the Microwave Drawer to facilitate cooking.
  - b** Remove wire twist-ties from paper or plastic bags before placing bag in Microwave Drawer.
  - c** If materials inside the Microwave Drawer ignite, keep Microwave Drawer door closed, turn microwave off and shut off power at the fuse or circuit breaker panel.
  - d** Do not use the Microwave Drawer for storage purposes. Do not leave paper products, cooking utensils, or food in the Microwave Drawer when not in use.
- 19** Liquids, such as water, coffee or tea are able to be overheated beyond the boiling point without appearing to be boiling due to surface tension of the liquid. Visible bubbling or boiling when the container is

removed from the Microwave Drawer is not always present. **THIS COULD RESULT IN VERY HOT LIQUIDS SUDDENLY BOILING OVER WHEN A SPOON OR OTHER UTENSIL IS INSERTED INTO THE LIQUID.**

To reduce the risk of injury to persons:

- a** Do not overheat the liquid.
- b** Stir the liquid both before and halfway through heating it.
- c** Do not use straight-sided containers with narrow necks. Use a wide-mouthed container.
- d** After heating, allow the container to stand in the Microwave Drawer at least for 20 seconds before removing the container.
- e** Use extreme care when inserting a spoon or other utensil into the container.

## SAVE THESE INSTRUCTIONS

### UNPACKING AND EXAMINING YOUR COOKTOP+MICROWAVE DRAWER

- 1** Remove all packing materials from inside the Microwave Drawer. **DO NOT REMOVE THE WAVEGUIDE COVER**, which is located on the top of the Microwave Drawer area.
- 2** Remove the feature sticker, if there is one, from the outside of the Microwave Drawer. Check the drawer for any damage, such as misaligned or bent drawer, damaged drawer seals and sealing surfaces, broken or loose Microwave Drawer guides and dents inside the cavity or on the front side of the drawer. If there is any damage, do not operate the Microwave Drawer and contact your dealer or a SHARP AUTHORIZED SERVICER.

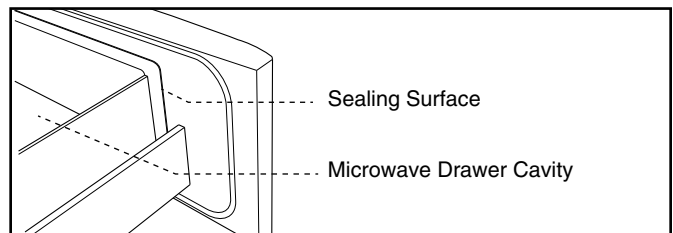
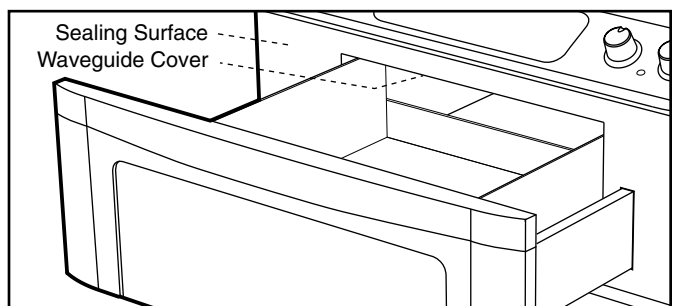

## PARTS NAME

### ELECTRIC COOKTOP WITH MICROWAVE DRAWER

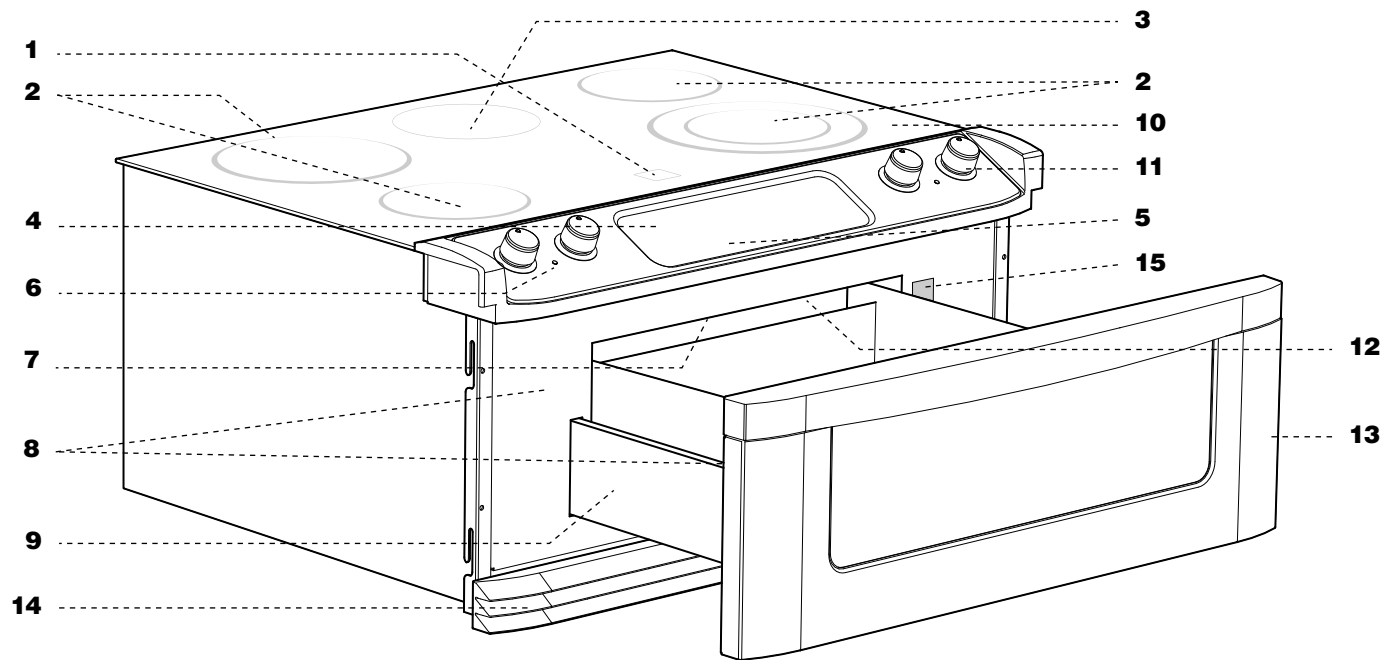

- 1** Hot surface indicator
- 2** Radiant surface units
- 3** Cooktop Warm Zone
- 4** Control panel
- 5** Cooktop Warm indicator
- 6** Cooktop-on indicator
- 7** Waveguide cover  
DO NOT REMOVE.

- 8** Drawer sealing surfaces
- 9** Microwave Drawer guides
- 10** Glass ceramic cooktop
- 11** Control knobs
- 12** Drawer light
- 13** Microwave Drawer™
- 14** Vent
- 15** Rating plate



**GLASS CERAMIC COOKTOP**

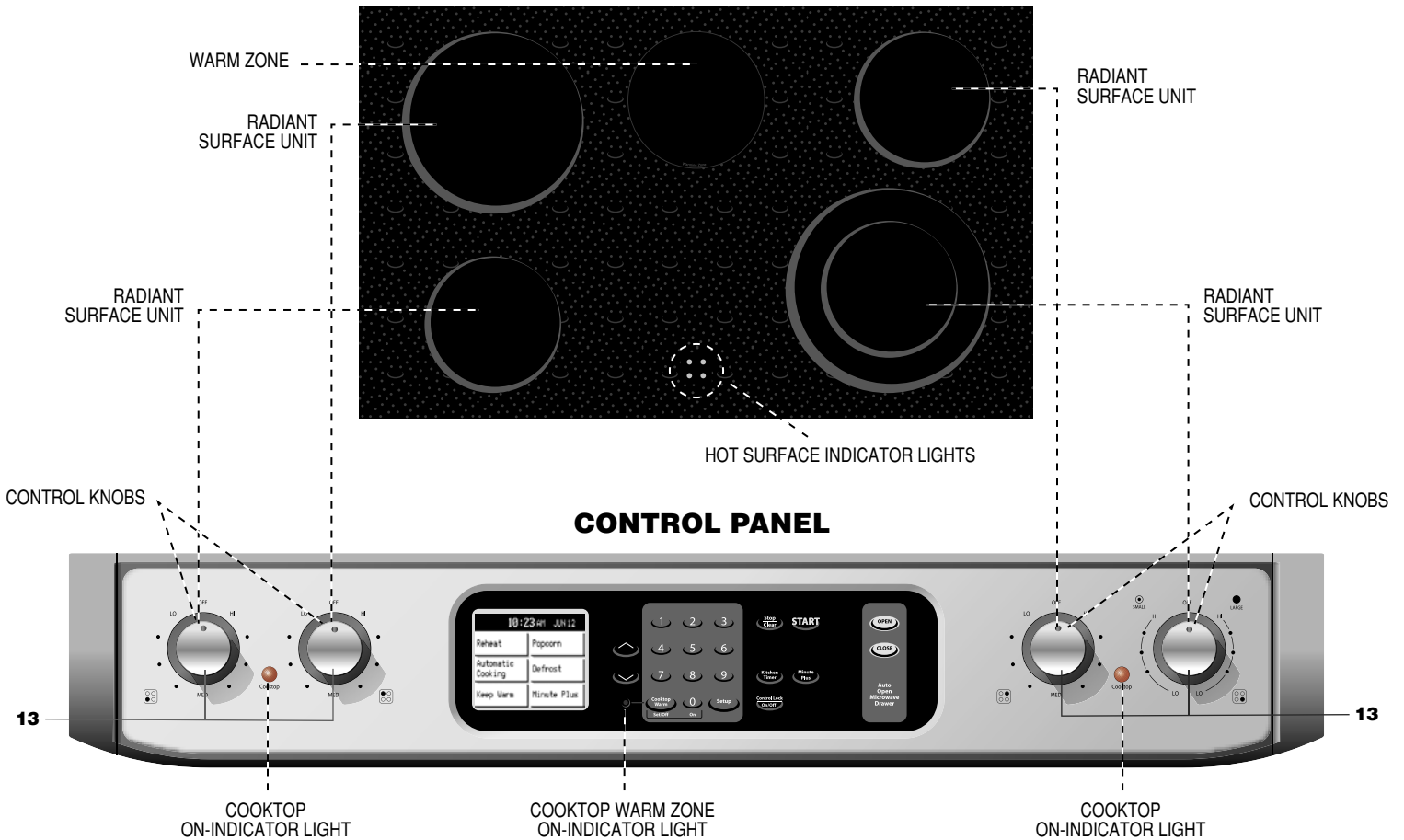

**KEYSHEET**

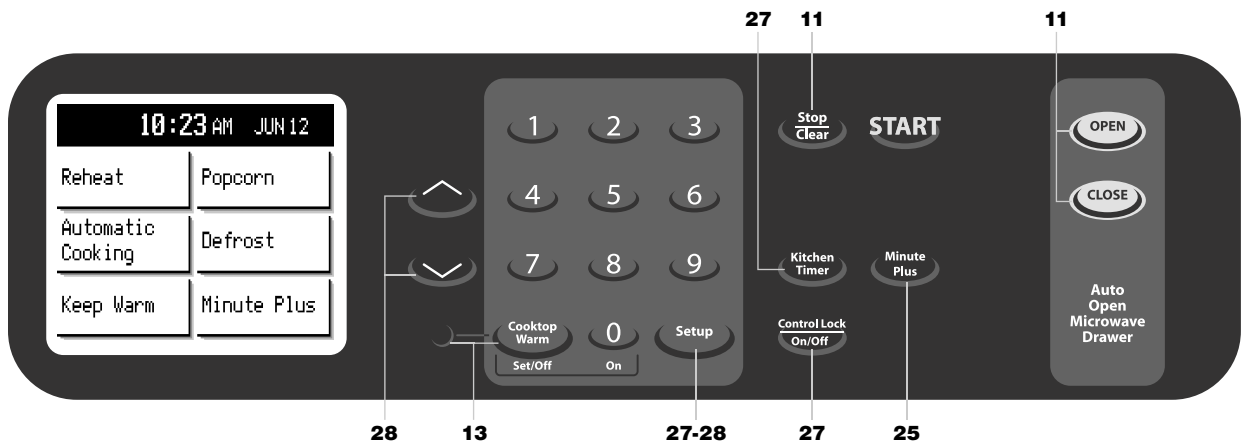

Numbers next to the keysheet illustration indicate pages on which there are feature descriptions and usage information.

## INTRODUCTION TO TOUCHSCREEN

This Sharp Insight Cooktop+Microwave Drawer features an LCD Touchscreen that is designed to make operation easy by providing step-by-step instructions right on the active touchscreen display.

After the time of day and date are set (instructions on next page), the Home Page will appear.

### TOUCHSCREEN DISPLAY



#### MICROWAVE DRAWER HOME PAGE

The Microwave Drawer Home Page gives you six options: Reheat, Defrost, Automatic Cooking, Popcorn, Minute Plus and Keep Warm. By simply touching one of these pads, you will see more options and specific directions. All of these settings are automatic, but microwave cooking times and power levels can be set manually, as well (see pages 16-17).

Just read the information on the touchscreen and follow the directions. You'll soon find that selecting from the various cooking options is easy and fun—and the guesswork has been eliminated. Please refer to detailed programming information on the following pages for specific features.

### BEFORE OPERATING

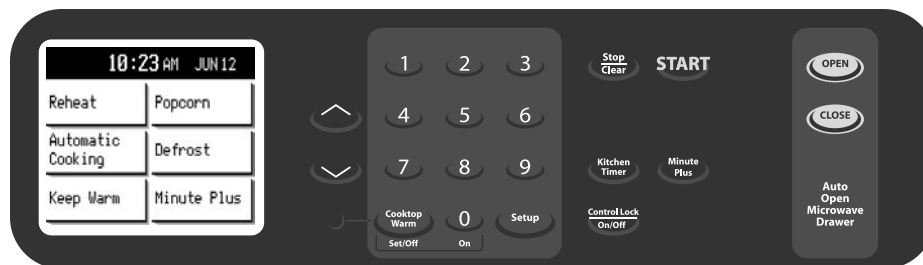

Before operating your new Cooktop+Microwave Drawer make sure you read and understand this operation manual completely.

- Before the Cooktop+Microwave Drawer can be used, follow these steps:

**1** Connect power supply to the Cooktop+Microwave Drawer by following all instructions in the installation manual. You can select either **Video Demo** or **Set Clock**.

**2** Touch **Set Clock** and follow the instructions below.

**Note:**

- If no choice is made for 30 seconds, the Video Demo will begin automatically. To cancel the Video Demo, Touch the **Stop/Clear** pad and the display will return to the Home Page. To set the clock, touch the **Setup** pad, touch **Clock** and follow the directions on the touchscreen.

## TO SET DATE AND TIME

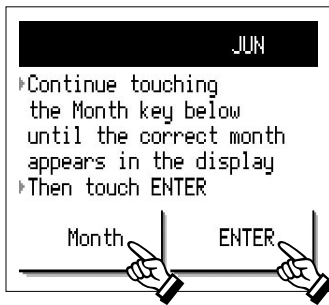

**1** After touching **Set Clock** or **Clock**, enter the correct month by touching **Month** repeatedly. The month appears in the banner at the top of the display. When set for the correct month, touch **ENTER**.

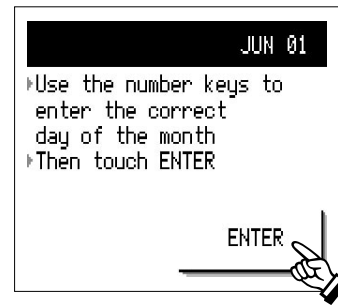

**2** Enter the date by touching the number pads on the control panel. Example: for June 1, touch **0****1**. Check the date in the banner, then touch **ENTER**.

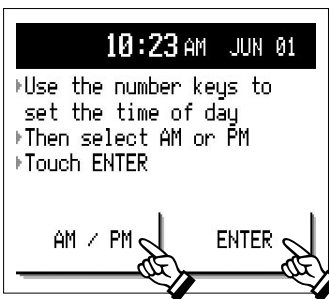

**3** Enter the time by touching the number pads. Select **AM/PM** and then touch **ENTER**.



**4** The month, date and time will appear in the banner. The display will return to the Home Page.

### Note:

- If you make a mistake while setting the clock, touch **Stop/Clear** pad. The Home Page will appear. To set clock again, touch **Setup** pad on the control panel. Then touch **Clock** and follow the directions.
- If you want to change the setting of the time of day, touch **Setup** pad and follow the directions.
- If the electrical power supply to your Cooktop+Microwave Drawer should be interrupted, the screen will intermittently show Video Demo or Set Clock after the power is reinstated. If this occurs during cooking, the program will be erased. Simply touch **Set Clock** and follow the directions.
- If the month, date and time are not set, “MICROWAVE DRAWER” will appear in the banner.

## STOP/CLEAR

Touch the **Stop/Clear** pad to:

- 1** Erase if you make a mistake during programming.
- 2** Stop the Microwave Drawer temporarily during timed cooking.
- 3** To cancel a program during cooking, touch twice for timed cooking.

## OPEN OR CLOSE MICROWAVE DRAWER

ALWAYS touch the **OPEN** or **CLOSE** pad on the control panel to open or close the Microwave Drawer.

**Do not push or pull the Microwave Drawer by hand, except in case of emergency such as a power failure.**

**If necessary, push or pull slowly.**

# COOKTOP USE

---

## INFORMATION YOU NEED TO KNOW

### ABOUT THE COOKTOP

- **Glass ceramic cooktop** - Make sure the surface and the pan bottom are clean before turning on. Do not use the cooktop if the glass is broken or if metal melts on it.
- **Radiant surface units** - The radiant surface heating units are beneath the smooth glass ceramic cooktop. The design on the cooktop outlines the area of the surface unit underneath. When the cooktop is on, the cooktop-on indicator, next to the surface cooking control knob, comes on even if the cooktop unit doesn't look red. The areas around the units may become hot enough to cause burns.
- **Hot surface indicator** - An indicator light, on the cooktop, comes on when the surface unit is turned on and the cooktop temperature increases. The indicator will remain on until the surface has cooled below 150°F even after the unit is turned off.
- **Temperature limiter** - The radiant surface units have a temperature limiter that allows the unit to cycle on and off, even at the HI setting. It protects the glass ceramic cooktop from damage. Cycling at the HI setting can occur when improper cookware is used.

#### Note:

- Never leave any items on the cooktop. Hot units may ignite flammable items, melt or soften plastics or increase pressure in closed containers causing them to burst.
- Don't store heavy items above the cooktop as they can cause damage if they drop on to the cooktop.
- Never cook directly on the cooktop. Always use cookware.

## ABOUT COOKING UTENSILS

For best results and energy conservation, choose cooking utensils as below.

- **Bottom of pan** - Pans should have flat bottoms that make good contact with the entire surface unit. Check for flatness by using a straight edge. Pans with curved or warped bottoms are not recommended.
- **Size of pan** - Pan size should match the amount of food and the size of the surface unit. Do not use canners or frypans that exceed the width of the radiant surface units.
- **Material of pan** - Always use a utensil for its intended purpose. Follow manufacturer's instructions. Some utensils were not made to be used on the cooktop.
- **Position of pan** - Always place the pan in the center of the surface unit you are using.
- **Wok Cooking** - Only a flat-bottomed wok is recommended. Do not use round-bottom wok or a wok with a support ring.

#### Note:

- Do not slide cookware across the cooktop surface because it can scratch the glass or may leave marks which need to be removed promptly.
- Never allow a pan to boil dry. This could damage the pan and the cooktop.
- Do not use aluminum foil on the cooktop surface.
- Do not use cooktop as a cutting board.

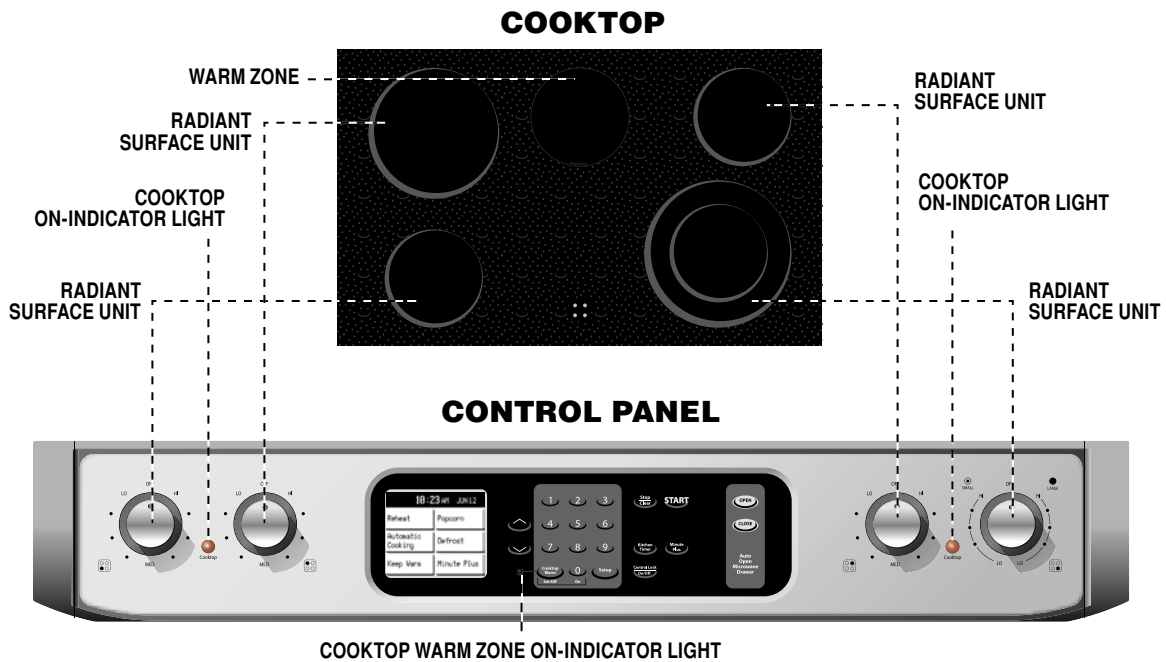

**RADIANT SURFACE UNITS**

Surface units are turned on and adjusted using the control knobs.

**HOW TO SET SINGLE SURFACE UNIT**

- 1 Place correctly sized cookware on the radiant surface unit.
- 2 Push the knob in and turn in either direction to the desired heat setting.
- 3 When cooking is completed, turn the knob to OFF. Remove pan.

**HOW TO SET DUAL SURFACE UNIT**

The right front surface unit has 2 cooking sizes so that you can choose either to match the diameter of the cookware you are using.

- 1 Place correct size cookware on the radiant surface unit.
- 2 To use the small surface unit, push the knob in and turn it to the left, counter clockwise.

To use the large surface unit, push the knob in and turn it to the right, clockwise.

- 3 When cooking is completed, turn the knob to OFF. Remove pan.

**Note for surface unit:** A hot surface indicator light in the center of the cooktop will glow when a radiant unit is turned on. It will remain on until the surface is cooled to about 150°F. Be sure the knob is turned to OFF when you have finished cooking.

The glass ceramic cooktop retains heat after the radiant surface units have been turned to OFF. If possible, turn the units off and allow foods to finish cooking with the retained heat. It may be necessary to remove the pan from the unit to prevent further cooking, also.

**SUGGESTED HEAT SETTINGS**

Setting	Type of cooking
High	Bring liquid to a boil. Always reduce setting to a lower heat when liquids begin to boil or foods begin to cook.
Medium High	Brown meat, heat oil for deep fat frying or to continue a rapid boil.
Medium	Maintain a slow boil, thicken sauces and gravies
Medium Low	Continue cooking covered foods or steam foods.
Low	Melt or simmer.

**Note:** The size and type of cookware used will influence the setting needed.

**COOKTOP WARM ZONE**

The Cooktop Warm Zone will keep hot cooked food at an ideal serving temperature. To turn Cooktop Warm on, touch the **Cooktop Warm** pad, then touch number **0** within 3 seconds. The red indicator will light. To turn the Cooktop Warm Zone off, touch the **Cooktop Warm** pad.

**CAUTION** The Cooktop Warm Zone will not glow red when it is hot, but it does become hot enough to cause burns. Always use oven mitts when removing food from the Warm Zone as cookware and plates will be hot. Use only cookware recommended for Cooktop cooking. Do not use plastic wrap to cover foods. Plastic may melt on to the surface and be very difficult to clean.

# MICROWAVE DRAWER COOKING

## INFORMATION YOU NEED TO KNOW

**ALWAYS** have food in the Microwave Drawer when it is on to absorb the microwave energy.

When using the Microwave Drawer at power levels below 100%, you may hear the magnetron cycling on and off. It is normal for the exterior of the Microwave Drawer to be warm to the touch when cooking or reheating.

Condensation is a normal part of microwave cooking. Room humidity and the moisture in food will influence the amount of moisture that condenses in the Microwave Drawer. Generally, covered foods will not cause as much condensation as uncovered ones. The vent under the Microwave Drawer must not be blocked. During microwaving, steam may come from the right side of the vent.

The Microwave Drawer is for food preparation only. It should not be used to dry clothes or newspapers.

Your Microwave Drawer is rated 1000 watts by using the IEC Test Procedure. In using recipes or package directions, check food a minute or two before the minimum time and add time accordingly.

When opening or closing the Microwave Drawer quickly, food in the Microwave Drawer may be spilled. To clean, please refer to the Cleaning and Care section on page 30.

## RADIO OR TV INTERFERENCE

Should there be any interference caused by the Microwave Drawer to your radio or TV, relocate the radio or TV as far away from the Cooktop+Microwave Drawer as feasible or check position and signal of receiving antenna.

## ABOUT MICROWAVE COOKING

- Arrange food carefully. Place thickest areas towards outside of dish.
- Watch cooking time. Cook for the shortest amount of time indicated and add more as needed. Food severely overcooked can smoke or ignite.
- Cover foods while cooking. Check recipe or cookbook for suggestions: paper towels, wax paper, microwave plastic wrap or a lid. Covers prevent splattering and help foods to cook evenly.
- Shield with small flat pieces of aluminum foil any thin areas of meat or poultry to prevent overcooking before dense, thick areas are cooked thoroughly.
- Stir foods from outside to center of dish once or twice during cooking, if possible.
- Turn foods over once during microwaving to speed cooking of such foods as chicken and hamburgers. Large items like roasts must be turned over at least once.
- Rearrange foods such as meatballs halfway through cooking both from top to bottom and from right to left.
- Add standing time. Remove food from Microwave Drawer and stir, if possible. Cover for standing time which allows the food to finish cooking without overcooking.

- Check for doneness. Look for signs indicating that cooking temperatures have been reached.

Doneness signs include:

- Food steams throughout, not just at edge.
- Center bottom of dish is very hot to the touch.
- Poultry thigh joints move easily.
- Meat and poultry show no pinkness.
- Fish is opaque and flakes easily with a fork.

## ABOUT UTENSILS AND COVERINGS

It is not necessary to buy all new cookware. Many pieces already in your kitchen can be used successfully in your new Microwave Drawer. Make sure the utensil does not touch the interior walls during cooking.

**Use these utensils for safe microwave cooking and reheating:**

- glass ceramic (Pyroceram®), such as Corningware®.
- heat-resistant glass (Pyrex®)
- microwave-safe plastics
- microwave-safe paper plates
- microwave-safe pottery, stoneware and porcelain
- browning dish (Do not exceed recommended preheating time. Follow manufacturer's directions.)

**These items can be used for short time reheating of foods that have little fat or sugar in them:**

- wood, straw, wicker

## DO NOT USE

- metal pans and bakeware
- dishes with metallic trim
- non-heat-resistant glass
- non-microwave-safe plastics (margarine tubs)
- recycled paper products
- brown paper bags
- food storage bags
- metal twist-ties

Should you wish to check if a dish is safe for microwaving, place the empty dish in the oven and microwave on HIGH for 30 seconds. A dish which becomes very hot should not be used.

**The following coverings are ideal:**

- Paper towels are good for covering foods for reheating and absorbing fat while cooking bacon.
- Wax paper can be used for cooking and reheating.
- Plastic wrap that is specially marked for microwave use can be used for cooking and reheating. DO NOT allow plastic wrap to touch food. Vent so steam can escape.
- Lids that are microwave-safe are a good choice because heat is kept near the food to hasten cooking.
- Oven cooking bags are good for large meats or foods that

## MICROWAVE DRAWER COOKING

need tenderizing. DO NOT use metal twist ties. Remember to slit bag so steam can escape.

### How to use aluminum foil in your Microwave Drawer:

- Small flat pieces of aluminum foil placed smoothly on the food can be used to shield areas that are either defrosting or cooking too quickly.
- Foil should not come closer than one inch to any surface of the Microwave Drawer.

Should you have questions about utensils or coverings, check a good microwave cookbook or follow recipe suggestions.

**ACCESSORIES** There are many microwave accessories available for purchase. Evaluate carefully before you purchase so that they meet your needs. A microwave-safe thermometer will assist you in determining correct doneness and assure you that foods have been cooked to safe temperatures. Sharp is not responsible for any damage to the Microwave Drawer when accessories are used.

### ABOUT CHILDREN AND THE MICROWAVE

Children below the age of 7 should use the Microwave Drawer with a supervising person very near to them. Between the ages of 7 and 12, the supervising person should be in the same room.

The child must be able to reach the Microwave Drawer comfortably.

At no time should anyone be allowed to lean or swing on the Microwave Drawer.

Children should be taught all safety precautions: use potholders, remove coverings carefully, pay special attention to packages that crisp food because they may be extra hot.

Don't assume that because a child has mastered one cooking skill he/she can cook everything.

Children need to learn that the Microwave Drawer is not a toy. See page 27 for Control Lock feature.

### ABOUT SAFETY

- Check foods to see that they are cooked to the United States Department of Agriculture's recommended temperatures.

160°F - For fresh pork, ground meat, boneless white poultry, fish, seafood, egg dishes and frozen prepared food.

165°F - For leftover, ready-to-reheat refrigerated, and deli and carry-out "fresh" food.

170°F - White meat of poultry.

180°F - Dark meat of poultry.

To test for doneness, insert a meat thermometer in a thick or dense area away from fat or bone. NEVER leave the thermometer in the food during cooking, unless it is approved for microwave use.

- ALWAYS use potholders to prevent burns when removing heated food from the Microwave Drawer or handling utensils

that are in contact with hot food. Enough heat from the food can transfer through utensils and to the bottom of the Microwave Drawer to cause skin burns.

- Avoid steam burns by directing steam away from the face and hands. Slowly lift the farthest edge of a dish's covering and carefully open popcorn and oven cooking bags away from the face.
- Stay near the Microwave Drawer while it's in use and check cooking progress frequently so that there is no chance of overcooking food.
- NEVER use the Microwave Drawer for storing cookbooks or other items.
- Select, store and handle food carefully to preserve its high quality and minimize the spread of foodborne bacteria.
- Keep waveguide cover clean. Food residue can cause arcing and/or fires. See page 30.

### ABOUT FOODS

FOOD	DO	DON'T
Eggs, sausages, fruits & vegetables	<ul style="list-style-type: none"> <li>• Puncture egg yolks before cooking to prevent "explosion".</li> <li>• Pierce skins of potatoes, apples, squash, hot dogs and sausages so that steam escapes.</li> </ul>	<ul style="list-style-type: none"> <li>• Cook eggs in shells.</li> <li>• Reheat whole eggs.</li> <li>• Dry nuts or seeds in shells.</li> </ul>
Popcorn	<ul style="list-style-type: none"> <li>• Use specially bagged popcorn for the microwave.</li> <li>• Listen while popping corn for the popping to slow to 1 or 2 seconds or use special <b>Popcorn</b> pad.</li> </ul>	<ul style="list-style-type: none"> <li>• Pop popcorn in regular brown bags or glass bowls.</li> <li>• Exceed maximum time on popcorn package.</li> </ul>
Baby food	<ul style="list-style-type: none"> <li>• Transfer baby food to small dish and heat carefully, stirring often. Check temperature before serving.</li> <li>• Put nipples on bottles after heating and shake thoroughly. "Wrist" test before feeding.</li> </ul>	<ul style="list-style-type: none"> <li>• Heat disposable bottles.</li> <li>• Heat bottles with nipples on.</li> <li>• Heat baby food in original jars.</li> </ul>
General	<ul style="list-style-type: none"> <li>• Cut baked goods with filling after heating to release steam and avoid burns.</li> <li>• Stir liquids briskly before and after heating to avoid "eruption".</li> <li>• Use deep bowl, when cooking liquids or cereals, to prevent boilovers.</li> <li>• Food should be shorter than the Microwave Drawer. Please refer to the height of side walls of the drawer.</li> </ul>	<ul style="list-style-type: none"> <li>• Heat or cook in closed glass jars or airtight containers.</li> <li>• Can in the microwave as harmful bacteria may not be destroyed.</li> <li>• Deep fat fry.</li> <li>• Dry wood, gourds, herbs or wet papers.</li> </ul>

# MICROWAVE DRAWER COOKING



## MANUAL OPERATION

### TIME COOKING

Your Microwave Drawer can be programmed for 99 minutes 99 seconds (99.99). Always enter the seconds after the minutes, even if they are both zeros.

### HIGH POWER COOKING

- Suppose you want to cook for 5 minutes at 100%.

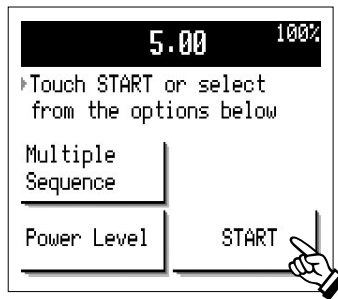

- 1 Enter cooking time by touching number pads **5|0|0**.
- 2 Note the top line of the display (the banner). Touch **START**. You can also activate the microwave by touching the **START** pad.
- 3 The display will begin counting down the cooking time. During cooking, the power level will appear in the display.

**Note:** If the Microwave Drawer is opened or **Stop/Clear** pad is touched once during cooking process, the cooking time in the display automatically stops. The cooking time starts to count down again when the Microwave Drawer is closed and the **START** pad is touched.

### VARIABLE POWER COOKING

There are eleven preset power levels. To change the power level, touch **Power Level** pad after entering the cooking time. Using lower power levels increases the cooking time which is recommended for foods such as cheese, milk and long slow cooking of meats. Consult cookbook or recipes for specific recommendations.

- Suppose you want to cook for 5 minutes at 30% power.

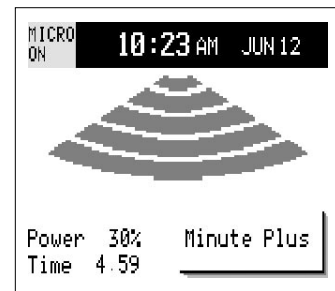
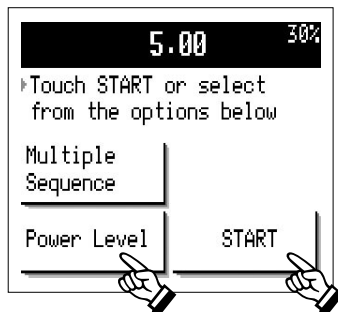

- 1 Enter cooking time by touching number pads **5|0|0**.
- 2 Touch **Power Level** 7 times for 30%. The top line of the display will show time and chosen power level. Touch **START**.
- 3 The display will begin counting down the cooking time. During cooking, the power level will appear in the display.



# MICROWAVE DRAWER COOKING

## MULTIPLE SEQUENCE COOKING

The Microwave Drawer can be programmed for up to four automatic cooking sequences, switching from one power level setting to another automatically. Sometimes cooking directions tell you to start on one power level and then change to a different power level. Your Microwave Drawer can do this automatically.

- Suppose you want to cook roast beef for 5 minutes at 70% power and then continue to cook for 30 minutes at 50% power.

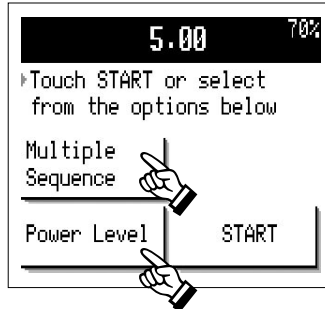

**1** Enter cooking time by touching number pads **5|0|0**.

**2** Touch **Power Level** 3 times to choose 70%. You can omit this step when you set 100% power. Touch **Multiple Sequence**.

**3** Note that 100% stage 2 appears in the banner.

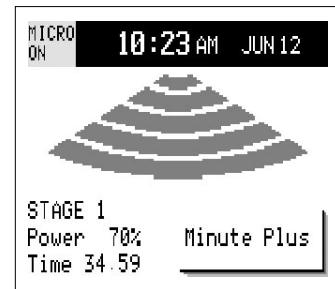
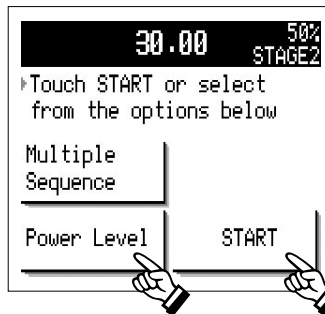

**4** Enter second cooking time **3|0|0|0**.

**5** Touch **Power Level** until 50% Stage 2 appears in the display. Touch **START**.

**6** The display will begin counting down the total cooking time.

During cooking, the power level will appear in the display. At the end of Stage 1, the microwave will automatically change to Stage 2.

## TO SET POWER LEVEL

There are eleven preset power levels.

Using lower power levels increases the cooking time, which is recommended for foods such as cheese, milk and long slow cooking of meats. Consult a microwave cookbook or recipes for specific recommendations.

TOUCH POWER LEVEL PAD NUMBER OF TIMES FOR DESIRED POWER	APPROXIMATE PERCENTAGE OF POWER	COMMON WORDS FOR POWER LEVELS
If Power Level is not touched	100%	High
Power Level x 1	90%	
Power Level x 2	80%	
Power Level x 3	70%	Medium High
Power Level x 4	60%	
Power Level x 5	50%	Medium

TOUCH POWER LEVEL PAD NUMBER OF TIMES FOR DESIRED POWER	APPROXIMATE PERCENTAGE OF POWER	COMMON WORDS FOR POWER LEVELS
Power Level x 6	40%	
Power Level x 7	30%	Med Low / Defrost
Power Level x 8	20%	
Power Level x 9	10%	Low
Power Level x 10	0%	
Power Level x 11	100%	High

# MICROWAVE DRAWER COOKING

## SENSOR SETTINGS

Sharp's Sensor is a semi-conductor device that detects the vapor (moisture and humidity) emitted from the food as it heats. The sensor adjusts the cooking times and power levels for various foods and quantities.

### USING SENSOR SETTINGS:

- 1 After the Cooktop+Microwave Drawer power supply is connected, wait 2 minutes before using any sensor setting.
- 2 Be sure the exterior of the cooking container and the interior of the Microwave Drawer are dry. Wipe off any moisture with a dry cloth or paper towel.
- 3 The sensor works with foods at normal storage temperature. For example, popcorn would be at room temperature.
- 4 Any sensor selection can be programmed with More/Less Time Adjustment. See page 26.
- 5 More or less food than the quantity listed in the charts should be cooked following the guidelines in any microwave cookbook.
- 6 During the first part of sensor use "Sensing" will flash on the display. Do not open the Microwave Drawer or touch **Stop/Clear** during this part of the cycle. The measurement of vapor will be interrupted. If this occurs, an error message will appear. To continue cooking, touch the **Stop/Clear** pad and cook manually. When the sensor detects the vapor emitted from the food, the remainder of cooking/reheating time will

appear. The Microwave Drawer may be opened when the remaining time appears on the display. At this time, you may stir or season food, as desired.

- 7 If the sensor does not detect vapor properly when cooking or reheating foods, error messages will be displayed, and the microwave will turn off.
- 8 Check food temperature after cooking. If additional time is needed, continue to cook manually.
- 9 Some foods have additional cooking tips in "Custom Help". Touch the **Custom Help** pad when it is showing in the display for additional cooking tips.

### COVERING FOODS:

Some foods work best when covered. Use the cover recommended in the procedure for these foods. You may refer to the hints by touching the **Custom Help** pad, when it is showing in the display.

- 1 Casserole lid.
- 2 Plastic wrap: Use plastic wrap recommended for microwave cooking. Cover dish loosely; allow approximately 1/2 inch to remain uncovered to allow steam to escape. Plastic wrap should not touch food.
- 3 Wax paper: Cover dish completely; fold excess wrap under dish to secure. If dish is wider than paper, overlap two pieces at least one inch to cover.

Be careful when removing any covering to allow steam to escape away from you.

## REHEAT

You can reheat many foods without the need to calculate cooking times or power levels.

When you select **Reheat** you will see six options. Most of these foods are reheated using the sensor. The foods that use the sensor are indicated with "\*" in the chart on page 19. When reheating foods with the sensor, it is not necessary to enter quantity or weight. See the sensor cooking information above.

Some foods are best reheated without using the sensor. For reheating these foods, simply follow the directions on the touchscreen to enter quantity or weight. Either way, you'll get automatic cooking without the guesswork.

See next page for programming instructions.

## MICROWAVE DRAWER COOKING

- Suppose you want to reheat 2 slices of pizza.



**1** Touch **Reheat** pad.



**2** Touch **Pizza** pad.

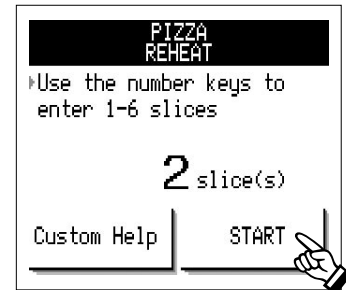

**3** Touch number **2** pad. You can touch **Custom Help** for additional information or simply touch **START**. See page 25 for more information on **Custom Help**.

The display will begin counting down the reheating time.

### REHEAT CHART

FOOD	AMOUNT
Refrigerated Foods*	4 - 36 oz.
Canned Foods*	4 - 36 oz.
Pizza	1 - 6 slices

FOOD	AMOUNT
Fresh Rolls or Muffins	1 - 8 pieces
Beverage Reheat	1/2 - 2 cups
Beverage Prepare	1 - 4 cups

\* It is not necessary to enter quantity or weight.

### POPCORN

You can pop popcorn with no need to calculate cooking time. Use only popcorn packaged for microwave oven use, one package at a time.

- Suppose you want to pop a regular size popcorn package.



**1** Touch **Popcorn** pad.

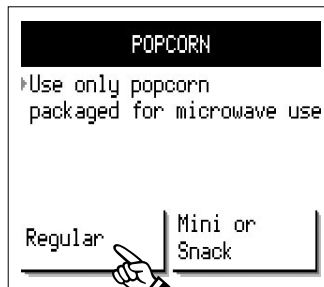

**2** Touch **Regular** pad. The microwave will start automatically.



**3** When the sensor detects the vapor emitted from the food, the display will begin counting down the cooking time. Follow the instructions at the end.

### POPCORN CHART

FOOD	AMOUNT
Regular / Regular light	2.85 - 3.5 oz.

FOOD	AMOUNT
Mini or Snack	1.2 - 1.75 oz.

# MICROWAVE DRAWER COOKING

## AUTOMATIC COOKING

Automatic Cooking has six categories and each category has several selections. Many sensor cooked foods are included. See the sensor cooking information on page 18. For foods not using the sensor, follow the directions on the touchscreen to enter quantity or weight. When cooking foods with the sensor, it is not necessary to enter quantity or weight. The foods using the sensor are indicated with “\*” in the chart below and on page 21.

- Suppose you want to cook a baked potato.



**1** Touch **Automatic Cooking** pad.



**2** Touch **Fresh Vegetables** pad.

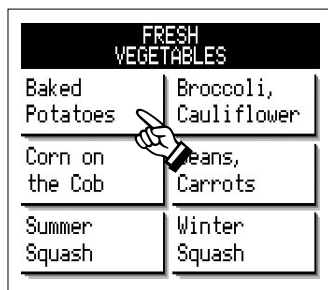

**3** Touch **Baked Potatoes** pad.



**4** Touch **START** pad. When the sensor detects the vapor emitted from the food, the display will begin counting down the cooking time.

### AUTOMATIC COOKING CHART

FRESH VEGETABLES	AMOUNT
Baked Potatoes*	1 - 6 medium
Broccoli, Cauliflower*	0.25 - 2.0 lb
Corn on the cob*	0.25 - 1.5 lb
Beans, Carrots*	0.25 - 1.5 lb
Summer Squash, Winter Squash*	0.25 - 2.0 lb
MEATS, POULTRY, SEAFOOD	AMOUNT
Ground Beef*	0.25 - 2.0 lb
Boneless Pork Loin	2.0 - 3.5 lb
Meat Loaf	1.0 - 2.0 lb
Spareribs	1.0 - 2.0 lb

MEATS, POULTRY, SEAFOOD	AMOUNT
Whole Chicken	2.5 - 6.0 lb
Bone-in Chicken*	0.5 - 3.0 lb
Boneless Poultry*	0.5 - 1.5 lb
Ground Poultry*	0.25 - 1.5 lb
Fish Fillets*	0.25 - 2.0 lb
Fish Steaks*	0.25 - 2.0 lb
Shellfish*	0.25 - 2.0 lb
Fish Kabobs*	0.25 - 1.0 lb

# MICROWAVE DRAWER COOKING

## AUTOMATIC COOKING CHART (CONT.)

FROZEN FOODS & SNACKS	AMOUNT
Vegetables*	0.25 - 1.25 lb
Entrees, Main Dishes*	6 - 40 oz
Snacks*	3 - 8 oz
Rolls or Muffins	1 - 8 pieces
Hot Dogs in Buns*	1 - 4
Soup*	1 - 6 cups
Chicken Nuggets*	0.25 - 1.0 lb
Soft Ice Cream	Pint, Quart, Half Gallon

\* It is not necessary to enter quantity or weight.

### Note:

- You can adjust doneness with More/Less Time Adjustment. See page 26.
- More or less than the quantity listed in the chart should be cooked following the guidelines in any microwave book.
- The final cooking result will vary according to the food condition (e.g. initial temperature, shape, quality, covering). Check food for temperature after cooking. If additional time is needed, continue to cook manually.

PASTA, GRAINS	AMOUNT
White Rice*	0.5 - 2.0 cups
Brown Rice*	0.5 - 2.0 cups
Fresh Pasta	8 - 9 oz
Dry Pasta	2 - 8 oz
BREAKFAST FOODS	AMOUNT
Scrambled Eggs	1 - 9 eggs
Bacon	2 - 6 slices
Hot Cereal	1 - 4 servings
Frozen Breakfast Foods*	1 (3 - 6 oz)

## RECIPES FOR ONE DISH DINNERS (RECIPES SERVE 4)

### Spicy Couscous

- 1 lb lean ground beef
  - 14<sup>1</sup>/<sub>2</sub> oz can diced tomatoes
  - 1 c tomato sauce
  - 1 medium onion, chopped
  - 1/4 c chopped green pepper
  - 1/2 c couscous
  - 1 clove garlic, minced
  - 1 tbsp chili powder
  - 1 tsp ground cumin
  - 1 tsp dried oregano leaves
  - 3/4 c raisins
- Garnish: yogurt and chopped fresh parsley

### Seafood Pasta

- 8 - 9 oz fresh tortellini
  - 1<sup>1</sup>/<sub>2</sub> c water
  - 1<sup>1</sup>/<sub>2</sub> c creamy Alfredo sauce
  - 1 lb raw shellfish like shrimp, scallops, crab
  - 2 c thinly sliced fresh vegetables like carrots, mushrooms, green beans
- Garnish: 1/4 c grated Parmesan cheese

### Salsa Chicken

- 1<sup>1</sup>/<sub>4</sub> oz dry taco seasoning
- 1 lb boneless chicken breast thin strips
- 6 oz pkg yellow rice mix with seasoning packet
- 2 c hot water
- 2 c frozen peas
- 1/2 c canned corn
- 1/2 c apricot preserves
- 14<sup>1</sup>/<sub>2</sub> oz can diced tomatoes

### Vegetarian Orzo

- 3/4 c orzo
  - 2<sup>1</sup>/<sub>2</sub> c vegetable bouillon
  - 2 tbsp pesto sauce
  - 1/3 c small pieces of sundried tomatoes
  - 2 tsp minced garlic
  - 2 tsp Italian seasoning
  - 2 c chopped green, red, orange & yellow peppers
  - 1 medium onion, thinly sliced
  - 14 oz can artichoke hearts, drained & quartered
  - 3 oz pitted ripe olives, cut in half
- Garnish:
- 1/3 c Parmesan cheese, freshly grated
  - 2 tbsp pinenuts

# MICROWAVE DRAWER COOKING

## RECIPES FOR LOW CALORIE ENTREES (RECIPES SERVE 4)

### Steak Fajitas

---

- 3/4 lb beef flank steak, cut in diagonal inch strips
- 1/3 c orange juice
- 2 tbsp lime juice
- 1 tbsp minced garlic
- 1 tbsp Worcestershire sauce
- 1 tbsp chili powder
- 1/2 tsp cumin
- 1 1/2 c red, green and yellow pepper strips
- 1 medium onion, chopped
- 1 c black beans, rinsed and drained
- 4 10-inch warm flour tortillas
- 1 medium tomato, chopped
- 1/3 c salsa
- 1/2 c fat free sour cream

### Glazed Pork Tenderloin

---

- 1 lb whole pork tenderloin
  - 1 tsp rosemary, salt and pepper
  - 1 lb sweet potatoes, 2-inch cubes
  - 1 orange, thinly sliced
- Glaze:
- 4 oz whole cranberry sauce
  - 1/4 c red wine
  - 1 tbsp steak sauce
  - 2 tbsp flour

### Thai Chicken Kabobs

---

- 2 tbsp lime juice
- 1 tsp cooking oil
- 1 tsp soy sauce
- 1/8 tsp red pepper
- 1 lb boneless chicken, cut in 1-inch cubes
- 4 small onions, quartered
- 2 medium red peppers, cut into 1-inch pieces
- 2 tsp light peanut butter

### Ratatouille

---

- 1/4 c olive oil
- 1 medium eggplant, peeled and cut in 1-inch cubes
- 1 medium onion, sliced thinly
- 4 small new potatoes, cut in 3/4-inch cubes
- 1 clove garlic, minced
- 1 medium zucchini, sliced thinly
- 1 green pepper, cut into thin strips
- 2 c sliced fresh mushrooms
- 14 1/2 oz can seasoned, diced tomatoes
- 1 1/2 tsp dried basil leaves
- 1 1/2 tsp marjoram leaves
- salt and pepper to taste

## RECIPES FOR SUPPER SOUPS & SAUCES (RECIPES SERVE 4)

### Chicken Noodle

---

- 1 tsp oil
- 1 onion, sliced thinly
- 1/2 c thin sliced celery
- 1 1/2 c thin sliced carrots
- 4 c chicken broth
- 1 lb bone-in chicken pieces
- 3/4 c fine egg noodles
- 1/3 c chopped parsley
- salt and pepper

### Split Pea Soup

---

- 3 c water
- 2 c vegetable bouillon
- 1/2 c dried split peas
- 1/3 c chopped onion
- 1 clove garlic, minced
- 1/4 tsp dried marjoram
- 1/4 tsp dried thyme leaves
- 1 bay leaf
- 1/8 tsp cayenne pepper
- 3/4 c sliced carrots
- 3/4 c diced potatoes
- 1/3 c sliced celery

# MICROWAVE DRAWER COOKING

## RECIPES FOR SUPPER SOUPS & SAUCES (RECIPES SERVE 4) CONT.

### Meat Sauce

---

- 3/4 lb ground beef
- 1/3 lb sweet Italian sausage
- 8 oz chopped, canned mushrooms, drained
- 1 small onion, minced
- 2 cloves garlic, minced
- 1 stalk celery, minced
- 1 carrot, minced
- 1/3 c red wine
- 1/3 c water
- 28 oz can tomato puree
- 6 oz can tomato paste
- 1 tsp sugar
- 1 tsp dried basil
- 1 tsp oregano
- 1/4 tsp crushed red pepper
- 1 tsp salt
- 1/4 tsp pepper

### Vegetarian Chili

---

- 3/4 c sliced carrots
- 3/4 c sliced celery
- 1/2 c chopped red pepper
- 1/2 c chopped green pepper
- 1/2 c sliced green beans
- 1 medium onion, minced
- 1 cloves garlic, minced
- 28 oz can crushed tomatoes
- 15 oz can kidney beans, rinsed and drained
- 15 oz can black beans, rinsed and drained
- 1 1/2 c water
- 1/3 c barley
- 1 tbsp chili powder
- 1/2 tsp cumin
- 2 tsp Italian seasoning
- 1/4 tsp pepper
- 1 tsp salt

Garnish: Parmesan cheese or sour cream

## RECIPES FOR DELICIOUS DESSERTS (RECIPES SERVE 4)

### Almond Bread Pudding

---

- 2 c half and half
- 2 tbsp unsalted butter, melted
- 2 large eggs, beaten
- 3/4 c sugar
- 1 tsp almond extract
- 1/2 c golden raisins
- 1/2 c slivered, blanched almonds, toasted
- 6 c 2-inch cubed French or Challah bread

Sauce:

- 1/4 c unsalted butter, melted
- 1/2 c sifted confectioners' sugar
- 1 large egg
- 2 tbsp bourbon

### Cherry Pie Pudding

---

- 21 oz cherry pie filling
- 4 c sponge or angel food cake cubes
- 2 c milk
- 4 eggs
- 1 tsp sugar
- 1/2 tsp almond extract
- 1 16 oz can drained, Bing cherries

### Caribbean Cake

---

- 2 tbsp butter, melted
- 1/4 c brown sugar
- 1/4 c apricot preserves
- 8 oz can crushed pineapple, drained well
- 2 tbsp sliced, blanched almonds
- 1/3 c dried, sweetened cranberries (Craisins)
- 1 9 oz pkg yellow cake mix or 1/2 box regular size
- 1 egg
- 2 tbsp rum
- 6 tbsp pineapple juice and/or water

### Turtle Bars

---

- 1 1/2 c quick oatmeal
- 1/2 c light brown sugar
- 1/2 c all-purpose flour
- 1/2 c melted butter
- 20 caramel candies
- 1 tbsp milk
- 1/2 c milk chocolate chips
- 1/2 c pecan pieces

# MICROWAVE DRAWER COOKING

## DEFROST

Defrost pad automatically defrosts all the foods found in the Defrost chart below.

- Suppose you want to defrost 1.2 lb ground meat.



1 Touch **Defrost** pad.

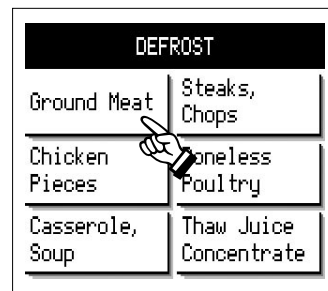

2 Touch **Ground Meat** pad.

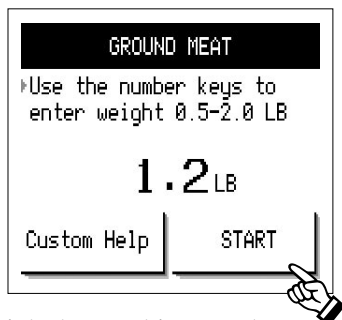

3 Enter weight by touching number pads **1****2**. Then touch **START**.



4 The display will begin counting down the defrosting time. Follow instructions at the end.

### DEFROST CHART

FOOD	AMOUNT
Ground Meat	0.5 - 2.0 lb
Steaks, Chops	0.5 - 3.0 lb
Chicken Pieces	0.5 - 3.0 lb

FOOD	AMOUNT
Boneless Poultry	0.5 - 2.0 lb
Casserole, Soup	1 - 6 cups
Juice Concentrate	6 oz, 12 oz, 16 oz

#### Note:

- You can input the amount only within the range in the Defrost Chart.
- Defrost can be programmed with More / Less Time Adjustment. See page 26.
- To defrost other foods or foods above or below the weights allowed on Defrost Chart, see Manual Defrost below.
- If the **Custom Help** pad appears, you can get additional information by touching it. To return to the previous page, touch the **^** pad, then touch **START** to begin defrosting.

### MANUAL DEFROST

If the food that you wish to defrost is not listed on the Defrost Chart or is above or below the limits in the AMOUNT column on the Defrost Chart, you need to defrost manually.

You can defrost any frozen food, either raw or previously cooked, by using 30% power. Estimate defrosting time, enter it and follow the exact procedure found on Variable Power Cooking on page 16.

For either raw or previously cooked frozen food the rule of thumb is approximately four minutes per pound. For example, defrost four minutes for one pound of frozen spaghetti sauce.

Always stop the Microwave Drawer periodically to remove or separate the portions that are defrosted. If food is not defrosted at the end of the estimated defrosting time, program the Microwave Drawer in one minute increments on 30% power until totally defrosted.

When using plastic containers from the freezer, defrost only long enough to remove from the plastic in order to place in a microwave-safe dish.



## OTHER CONVENIENT FEATURES

### KEEP WARM

Keep Warm allows you to keep food warm up to 30 minutes.

- Suppose you want to keep food warm for 20 minutes.



**1** Touch **Keep Warm** pad.

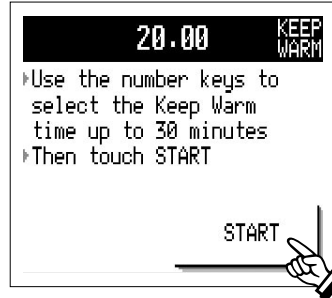

**2** Enter time by touching number pads **2|0|0|0**. Then touch **START**.



**3** The display will begin counting down the keep warm time.

**Note:** If you attempt to enter more than 30 minutes for Keep Warm, an error message will appear in the display.

### MINUTE PLUS™

Minute Plus allows you to cook for a minute at 100% by simply touching the **Minute Plus** pad. You can also extend cooking time in multiples of 1 minute by repeatedly touching the **Minute Plus** pad during manual cooking.

There are several ways to access the **Minute Plus** pad.

**1** **Minute Plus** appears on the control panel.

**2** If you touch the **Minute Plus** pad on the touchscreen, microwave cooking will start immediately. You can add time in one minute increments by touching this pad during cooking.

**3** When you have set microwave cooking time manually, the **Minute Plus** pad will appear on the touchscreen. You can add time in one minute increments by touching this pad.

**Note:**

- To use Minute Plus, touch **Minute Plus** pad within 3 minutes after cooking, closing the Microwave Drawer or touching the **Stop/Clear** pad.
- Minute Plus cannot be used with any of the automatic settings nor with Keep Warm.

### CUSTOM HELP®

When you are using the automatic cooking features, sometimes you will see the **Custom Help** pad appear. By touching it, you will see additional cooking tips and information. Often this information is already displayed on the touchscreen, but occasionally because of space, the **Custom Help** pad is used to get to another screen for additional help. Once you have read the information in Custom Help, use the  pad on the control panel to return to the previous screen.

# MICROWAVE DRAWER COOKING

## MORE/LESS TIME ADJUSTMENT

The programmed cooking times are tailored to the most popular tastes. To adjust the cooking time to your individual preference, use the **More/Less** pad to either add or reduce cooking time.

- Suppose you want to reheat a refrigerated food for more time.

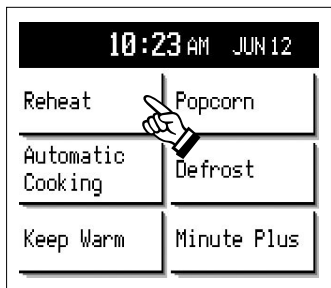

**1** Touch **Reheat** pad.



**2** Touch **Refrigerated Foods** pad.



**3** Then touch **START**.

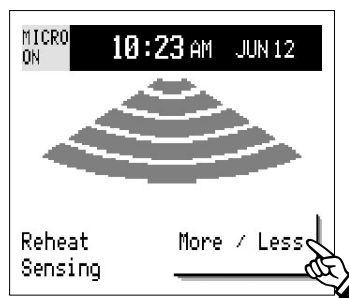

**4** After touching the **START** pad, **More/Less** will appear. Touch once for more time.

### Note:

- For less time, touch **More/Less** pad again. The word "MORE" or "LESS" will appear in the lower left-hand corner of the display to confirm your selection.
- Choosing More/Less time must be done within seven seconds after touching **START**.

## KITCHEN TIMER

- Suppose you want to set Kitchen Timer for 15 minutes.



**1** Touch **Kitchen Timer** pad on the control panel.



**2** Touch **Min/Sec** pad\*.



**3** To set time, touch number pads **1500** and touch **Kitchen Timer** pad.

### TO CANCEL, TOUCH AND HOLD KITCHEN TIMER PAD FOR 3 SECONDS.

\* If you want to set the Kitchen Timer in hours and minutes, touch **Hr/Min** pad. Example: To set 1 hour 15 minutes, touch **115**. Check the Kitchen Timer in the banner to make sure you have set the timer as you desired. When the countdown timer reaches 59 minutes, 59 seconds, it will count down in minutes and seconds.

## CONTROL LOCK

The Control Lock prevents unwanted Microwave Drawer and Cooktop Warm operation, such as by small children. It can be set so that the control panel is deactivated or locked. All Microwave Drawer and Cooktop Warm functions must be off with Home Page showing and the Microwave Drawer closed before setting.

### TO LOCK

Touch **Control Lock** and hold for 3 seconds. The display shows "CONTROL PANEL LOCKED".

### TO UNLOCK

Touch **Control Lock** and hold for 3 seconds. The display shows "CONTROL PANEL UNLOCKED".

**Note:** Control Lock can be used only when the Microwave Drawer is not in operation, Cooktop Warm is OFF and drawer is closed. The Cooktop can be used (except for Cooktop Warm) when the **Control Lock** is on.

## SETUP

The Setup has eight functions.

1. Clock
2. Delay Start
3. Sound Adjustment
4. Screen Contrast
5. Continuous Reminder
6. Sleep Mode
7. Video Demo
8. Demo Mode

### CLOCK

Touch **Setup**, touch **Clock**, and then follow the directions on the screen. See page 11.

### DELAY START

The Delay Start function allows you to set your Microwave

Drawer to start automatically at a later time. Touch **Setup**, touch **Delay Start** to program the Microwave Drawer to begin cooking automatically at a designated time. Follow the directions on the screen.

### SOUND ADJUSTMENT

The Microwave Drawer offers a choice of Sound On or Sound Off (no sound). Touch **Setup**, touch **Sound Adjustment** and then follow the directions on the screen.

### SCREEN CONTRAST

Normally there is no need to change the display contrast; however, should you wish to do so, press **Setup**, touch **Screen Contrast** and follow the directions on the screen.

### CONTINUOUS REMINDER

At end of cooking, Microwave Drawer will signal every 10 seconds for the first minute, then every 3 minutes for 1 hour until the drawer is opened or **Stop/Clear** pad is touched. This function can be canceled. Press **Setup**, touch **Continuous Reminder** and then follow the directions on the screen.

### SLEEP MODE

The backlight of the display will automatically turn off after 15 minutes if the unit has not been in operation. The information in the display will remain, but the display will not remain lighted. The display will not go into the Sleep Mode during cooking or while the Demo Mode is set.

If the display is "sleeping", simply touch any pad on the touchscreen or on the control panel to turn the back light on. The Sleep Mode feature can be deactivated, if desired.

To deactivate the Sleep Mode, touch **Setup**, touch **Sleep Mode** and then touch **Sleep Mode OFF**. The backlight on the display will remain on all of the time.

To re-activate the Sleep Mode, touch **Setup**, touch **Sleep Mode ON**, touch **Sleep Mode** and then touch **Sleep Mode ON**.

## OTHER FEATURES

---

### VIDEO DEMO

The Video Demo is an automated “tour” through many of the features of this Cooktop+Microwave Drawer. To see a video demo, press **Setup**, touch , touch **Video Demo** and then touch **Video Demo ON**.

### DEMO MODE



The Demo Mode is a learning tool. Using this function, the Microwave Drawer will not heat. The count down timer moves very quickly.

To use Demo Mode, touch **Setup**, touch , touch **Demo Mode** and then touch **Demo Mode ON**.

Whenever the **Demo Mode** is turned on, the word “DEMO” will flash in the upper left-hand corner of the banner. If the Demo Mode is on and the Cooktop+Microwave Drawer is not used for one minute, the Video Demo will play. To turn it off, follow the directions in the display or touch **Stop/Clear**.

To cancel Demo Mode, touch **Setup**, touch , touch **Demo Mode** and then touch **Demo Mode OFF**.

### PAGE FORWARD AND BACK

The Page FORWARD  and Page BACK  pads on the Control Panel allow you to scroll the touchscreen forward and backward when these symbols appear in the banner of the display. These symbols appear primarily on the recipe screens and allow you to look at the entire recipe before beginning preparation. You will also see the  symbol when you have selected Custom Help or have made a mistake. Touching this pad will return the display to the previous screen.

Before cleaning any part of the Cooktop+Microwave Drawer, be sure all controls are turned OFF and all surfaces are cool.

### NON-COOKTOP SURFACES

#### EXTERIOR

The outside surface is precoated metal and plastic. Clean the outside with mild soap and water; rinse and dry with a soft cloth. Do not use any type of household or abrasive cleaner.

#### STAINLESS STEEL SURFACE (SELECT MODELS)

The exterior should be wiped often with a soft damp cloth and polished with a soft dry cloth to maintain its beauty. There are also a variety of products designed especially for cleaning and shining stainless steel appliances. We recommend that the cleaner be applied to a soft cloth and then carefully used on the stainless exterior rather than sprayed directly on to it. Follow package directions carefully.

#### OUTSIDE OF THE DOOR

Wipe the window on both sides with a soft damp cloth to remove any spills or splatters. Metal parts will be easier to maintain if wiped frequently with a soft damp cloth. Avoid the use of spray and other harsh cleaners as they may stain, streak or dull the door surface.

#### CONTROL KNOBS

The control knobs may be removed for easier cleaning. Before removing the knobs, make sure the knobs are in the OFF position. Clean with a soft cloth dampened with mild soap and water; rinse and dry with a soft cloth. When replacing the knobs, check the OFF position to insure proper placement.

#### TOUCH CONTROL PANEL

If desired, the touch pads may be deactivated before cleaning. See the Control Lock information on page 27 of this manual. Wipe the panel with a cloth dampened slightly with water only. Dry with a soft cloth. Do not scrub or use any sort of chemical cleaners. Close door and touch **Stop/Clear**.

### COOKTOP

If the cooktop should crack or break, do not use or attempt to clean it. Call an authorized servicer.

#### NORMAL DAILY USE CLEANING

Only use cleaning products that have been specifically designed for glass ceramic cooktops. Read and follow all instructions and warnings on the cleaning cream label. A sample cleaner cream is supplied with your Cooktop+Microwave Drawer.

Before using the cooktop, clean the cooktop with the cleaner cream. To avoid possible damage to the cooking surface, do not apply cleaning cream to the glass surface when it is hot.

We recommend that you avoid wiping any surface unit areas until they have cooled and the hot surface indicator light has gone off. Sugar spills are the exception to this.

**1** Apply a few drops of cleaner cream to the cooktop that is not hot.

**2** Dampen clean paper towel and clean top.

**3** Wipe off with another clean, damp paper towel, then wipe dry.

#### Note:

- Make sure bottom of cookware and cooking area are clean and dry before turning on the cooktop.
- Wipe up food spills and splatters before they burn on the surface.
- Do not mix cleaning products. Mixtures may interact and damage the surface.

#### SUGARY SPILLOVERS (JELLIES, FUDGE, CANDY, SYRUPS ETC.), MELTED PLASTICS OR HEAVY BURNED ON RESIDUE

Sugary spillovers, melted plastics or heavy burned on residue can cause pitting of the surface of your cooktop unless the spill is removed while still hot.

You must begin cleaning the spills while the cooktop is still hot.

**1** Turn off all surface units and remove all pans immediately.

**2** Wearing an oven mitt, use a razor blade scraper at a 30 degree angle against the glass ceramic surface and scrape from hot surface to a cooler area.

**3** Remove the spills with paper towels.

#### Note:

- Do not use a dull or nicked blade. Be sure to use a new, sharp razor scraper.
- Do not use the razor blade for daily cleaning as it may wear the pattern on the glass.

#### METAL MARKS OR BURNED ON RESIDUE

Metal marks and burned on residue should be removed immediately after the cooktop has cooled. Metal marks can become permanent if not removed prior to future use.

**1** Dampen a “scratchless” or “never scratch” pad that is safe for non-stick cookware. The pattern and glass will be damaged if the pad is not damp or is soiled or if another type of pad is used. Apply a cleaner cream for glass ceramic cooktops.

**2** Scrub to remove as much soil as possible.

**3** Apply the cleaner cream over the soil, cover with a damp paper towel and let stand 30 minutes to 1 hour. Keep moist by covering the paper towel with plastic wrap.

**4** Scrub again and wipe off with another clean, damp paper towel. Then wipe dry.

## CLEANING AND CARE

---

### Note:

- Do not use aluminum foil on the cooktop.
- If pots or pans of aluminum or copper are allowed to boil dry, permanent damage may affect the ceramic glass surface.
- Do not slide pots and pans across the cooktop surface.
- Cookware with rough bottoms can mark or scratch the cooktop surface.
- Do not use a dull or nicked blade. Be sure to use a new, sharp razor scraper.

## MICROWAVE DRAWER

### INTERIOR

Cleaning is easy because no heat is generated to the interior surfaces; therefore, there is no baking and setting of spills or spattering. To clean the interior surfaces, including drawer sealing surfaces, wipe with a soft damp cloth. **DO NOT USE ABRASIVE OR HARSH CLEANERS OR SCOURING PADS.** For heavier soil, use mild soap; wipe clean with a soft damp cloth. Do not use any chemical oven cleaners.

## MICROWAVE DRAWER GUIDES

Remove the food crumbs from the Microwave Drawer guides. Wipe with a soft dry cloth in order to keep the Microwave Drawer opening and closing easily.

## WAVEGUIDE COVER

**ATTENTION** The waveguide cover (located on the inside top of the Microwave Drawer) is made from mica, so it requires special care. Keep the waveguide cover clean to assure good microwave performance. Carefully wipe with a soft damp cloth any food spatters from the surface of the cover immediately after they occur. Built-up splashes may overheat and cause smoke or possibly catch fire. Do not remove the waveguide cover.

## ODOR REMOVAL

Occasionally, a cooking odor may remain in the Microwave Drawer. To remove, combine 1 cup water, grated peel and juice of one lemon and several whole cloves in a 2-cup glass measuring cup. Boil for several minutes using 100% power. Allow to sit in the Microwave Drawer until cool. Wipe interior with a soft cloth.

## BEFORE YOU CALL FOR SERVICE

Please check the following before calling for service. It may save you time and expense.

PROBLEM	POSSIBLE CAUSE	SOLUTION
<b>1</b> Part or all of Cooktop+Microwave Drawer does not operate.	<ul style="list-style-type: none"> <li>• Power outage.</li> <li>• Fuse/circuit breaker at home doesn't work.</li> <li>• Microwave Drawer is in Demo Mode.</li> </ul>	<ul style="list-style-type: none"> <li>• Check house lights to be sure. Call your local electric company for service.</li> <li>• Replace the fuse or reset the circuit breaker.</li> <li>• See page 28 for how to cancel Demo Mode.</li> </ul>
<b>2</b> Surface units do not heat.	<ul style="list-style-type: none"> <li>• No power to the appliance.</li> <li>• Surface controls improperly set.</li> </ul>	<ul style="list-style-type: none"> <li>• See SOLUTION for PROBLEM 1.</li> <li>• Check if the controls have been properly set. See page 13.</li> </ul>
<b>3</b> Surface units too hot or not hot enough.	<ul style="list-style-type: none"> <li>• Improper cookware being used.</li> </ul>	<ul style="list-style-type: none"> <li>• Use pans which are flat and match the diameter of the surface unit selected.</li> </ul>
<b>4</b> Surface unit stops glowing.	<ul style="list-style-type: none"> <li>• It is normal when turned to a lower setting.</li> </ul>	
<b>5</b> Scratches on glass ceramic cooktop.	<ul style="list-style-type: none"> <li>• Incorrect cleaning methods were used.</li> <li>• Cookware with rough bottom has been used.</li> </ul>	<ul style="list-style-type: none"> <li>• Use the recommended cleaning procedure. See pages 29-30.</li> <li>• Use smooth, flat-bottomed cookware.</li> </ul>
<b>6</b> Areas of discoloration on the cooktop.	<ul style="list-style-type: none"> <li>• Food spillovers not cleaned before next use.</li> </ul>	<ul style="list-style-type: none"> <li>• Use the recommended cleaning procedure. See pages 29-30.</li> </ul>
<b>7</b> Metal marks on cooktop.	<ul style="list-style-type: none"> <li>• Sliding or scraping of metal pans on top.</li> </ul>	<ul style="list-style-type: none"> <li>• Do not slide metal pans. When cool, clean with cooktop cleaning cream to remove the marks.</li> </ul>
<b>8</b> Brown streaks or specks on cooktop glass surface.	<ul style="list-style-type: none"> <li>• Boilovers are cooked onto surface.</li> </ul>	<ul style="list-style-type: none"> <li>• Use the recommended cleaning procedure. See pages 29-30.</li> </ul>
<b>9</b> Food in Microwave Drawer is not heated.	<ul style="list-style-type: none"> <li>• No power to the appliance.</li> <li>• Microwave Drawer controls improperly set.</li> <li>• Microwave Drawer is in Demo Mode.</li> </ul>	<ul style="list-style-type: none"> <li>• See SOLUTION for PROBLEM 1.</li> <li>• Check if the controls have been properly set. See pages 16-17.</li> <li>• See page 28.</li> </ul>
<b>10</b> Microwave Drawer light does not work.	<ul style="list-style-type: none"> <li>• Light bulb is loose or burned out.</li> </ul>	<ul style="list-style-type: none"> <li>• Call for service.</li> </ul>
<b>11</b> Touch controls will not operate.	<ul style="list-style-type: none"> <li>• Control Lock is on.</li> </ul>	<ul style="list-style-type: none"> <li>• See page 27 to unlock.</li> </ul>
<b>12</b> Strong odor or light smoke when Cooktop is turned on.	<ul style="list-style-type: none"> <li>• This is normal for a new Cooktop.</li> </ul>	<ul style="list-style-type: none"> <li>• It will disappear after a few uses. Ventilate the room to remove odors more quickly.</li> </ul>
<b>13</b> Display intermittently shows Video Demo and Set Clock.	<ul style="list-style-type: none"> <li>• Power failure.</li> </ul>	<ul style="list-style-type: none"> <li>• Touch <b>Set Clock</b> pad on the display and follow the directions. If the oven was in use, you must reset the cooking function.</li> </ul>
<b>14</b> Steam from the vent.	<ul style="list-style-type: none"> <li>• When using the microwave feature, it is normal to see steam from the food coming out of the vent.</li> </ul>	

# AUTO-TOUCH GUIDE

For more complete information and safety precautions, refer to your Operation Manual.

## MICROWAVE DRAWER

### SET DATE AND TIME

If the Cooktop+Microwave Drawer has just been plugged in, touch **Set Clock** on the screen and follow the directions. To reset the clock, touch **Setup** pad on the control panel.

- 1 Touch **Clock** pad, enter the correct month by touching **Month** repeatedly. Touch **ENTER**.
- 2 Touch number pads for correct date and touch **ENTER**.
- 3 Touch number pads for correct time. Select AM/PM and then touch **ENTER**.

### MANUAL OPERATION

#### High Power Cooking

- 1 Touch number pads on the control panel to enter the cooking time.
- 2 Touch **START**.

#### Variable Power Cooking

- 1 Touch number pads on the control panel to enter the cooking time.
- 2 Touch **Power Level** pad continuously for desired power level.
- 3 Touch **START**.

### REHEAT

- 1 Touch **Reheat** pad on the screen.
- 2 Select the desired food.
- 3 Follow directions on the screen.

### POPCORN

- 1 Touch **Popcorn** pad on the screen.
- 2 Select the desired type of popcorn from the screen.
- 3 Follow directions on the screen.

### AUTOMATIC COOKING

- 1 Touch **Automatic Cooking**.
- 2 Select the desired food from the screen.
- 3 Follow directions on the screen.

### DEFROST

- 1 Touch **Defrost** pad on the screen.
- 2 Select the desired food from the screen.
- 3 Follow directions on the screen.

### KEEP WARM

- 1 Touch **Keep Warm** pad on the screen.
- 2 Touch number pads on the control panel to enter the Keep Warm time.
- 3 Touch **START**.

### MINUTE PLUS

Minute Plus allows you to cook for one minute at 100% power with each touch. There are two ways to access the **Minute Plus** pad.

- 1 Touch **Minute Plus** pad on the control panel.
- 2 Touch **Minute Plus** pad on the screen.

### MORE/LESS TIME ADJUSTMENT

To adjust the cooking time to your individual preference.

- 1 Select microwave desired options.
- 2 Follow directions on the screen.
- 3 The **More/Less** pad will appear at the count down time. Touch once for More, twice for Less.

## OTHER FEATURES

### KITCHEN TIMER

- 1 Touch **Kitchen Timer** pad on the control panel.
- 2 Select the desired setting.
- 3 Follow the directions.

To cancel Kitchen Timer, touch and hold the **Kitchen Timer** pad for 3 seconds.

### CONTROL LOCK

The Control Lock prevents unwanted drawer operation such as by small children. The Microwave Drawer can be set so that the control panel is deactivated or locked.

#### To Lock

With Home Page showing, touch **Control Lock** pad on the control panel and hold for 3 seconds.

#### To Unlock

With Home Page showing, touch **Control Lock** pad on the control panel and hold for 3 seconds.

### SETUP

The Setup has eight functions. Check operation manual for specific details.

Clock	Continuous Reminder
Delay Start	Sleep Mode
Sound Adjustment	Video Demo
Screen Contrast	Demo Mode

# SHARP®

SHARP ELECTRONICS CORPORATION • Sharp Plaza, Mahwah, New Jersey 07430-2135

TINSEB432MRK1

