

OPERATION MANUAL

MODELS

KB-3425J / KB-4425J

Followed by indicating color: K = black, W = white, S = stainless steel



KB-4425J

CONTENTS	2	BEFORE OPERATING	13-14
CUSTOMER ASSISTANCE	3	COOKTOP USE	14-15
PRECAUTIONS TO AVOID POSSIBLE EXPOSURE TO EXCESSIVE MICROWAVE ENERGY	3	MICROWAVE DRAWER™ COOKING	16-28
CONSUMER LIMITED WARRANTY	4	OVEN COOKING	29-34
IMPORTANT SAFETY INSTRUCTIONS	5-7	OVEN COOKING-CONVECTION	35-38
UNPACKING AND EXAMINING YOUR RANGE	7	OTHER FEATURES	39-41
PARTS NAME	8-11	CLEANING AND CARE	42-44
INTRODUCTION TO TOUCHSCREEN	12	BEFORE YOU CALL FOR SERVICE	45-46
		AUTO-TOUCH GUIDE	47-BACK COVER

CONTENTS

CONTENTS	2	MINUTE PLUS™	27
CUSTOMER ASSISTANCE	3	CUSTOM HELP®	27
PRECAUTIONS TO AVOID POSSIBLE EXPOSURE TO EXCESSIVE MICROWAVE ENERGY	3	MORE / LESS TIME ADJUSTMENT	28
CONSUMER LIMITED WARRANTY	4	OVEN COOKING	29-34
PRODUCT INFORMATION CARD	4	INFORMATION YOU NEED TO KNOW	29
IMPORTANT SAFETY INSTRUCTIONS	5-7	BEFORE USING OVEN	29
IMPORTANT SAFETY NOTICE AND WARNING	5	OVEN BAKING AND BROILING.....	29
SAFETY PRECAUTIONS	5	HOW TO SET OVEN TEMPERATURE FOR BAKE.....	30
RADIANT SURFACE UNITS.....	5-6	HOW TO PROOF	30
MICROWAVE DRAWER™	6-7	HOW TO SET TIMED COOK	31
OVEN	7	HOW TO SET DELAY START	32
SELF-CLEANING OVEN.....	7	HOW TO SET BROIL	33-34
UNPACKING AND EXAMINING YOUR RANGE	7	BROILING CHART.....	34
PARTS NAME	8-11	OVEN COOKING-CONVECTION	35-38
ELECTRIC RANGE WITH MICROWAVE DRAWER.....	8-9	CONVECTION COOKING.....	35
ADJUSTABLE HEIGHT BACKSPLASH	9	HOW TO SET OVEN TEMPERATURE FOR CONVECTION BAKE.....	35-36
EZ PULL OVEN RACK INSTRUCTIONS	10	CONVECTION ROAST	36
GLASS CERAMIC COOKTOP, CONTROL PANEL AND KEYSHEET	11	HOW TO SET CONVECTION ROAST	36-37
INTRODUCTION TO TOUCHSCREEN	12	HOW TO SET DELAY START	37
BEFORE OPERATING	13-14	CONVECTION BROIL	38
TO SET DATE AND TIME	13	HOW TO SET CONVECTION BROIL	38
STOP/CLEAR	14	CONVECTION BROILING CHART.....	38
OPEN OR CLOSE MICROWAVE DRAWER	14	OTHER FEATURES	39-41
COOKTOP USE	14-15	HOW TO START SELF-CLEAN	39
INFORMATION YOU NEED TO KNOW	14	HOW TO SET SELF-CLEAN DELAY START	39
RADIANT SURFACE UNITS.....	15	OVEN LIGHT	40
SUGGESTED HEAT SETTINGS.....	15	KITCHEN TIMER	40
COOKTOP WARM ZONE	15	CONTROL LOCK	40
MICROWAVE DRAWER COOKING	16-28	SETUP.....	40-41
INFORMATION YOU NEED TO KNOW.....	16-17	PAGE FORWARD AND BACKWARD.....	41
MANUAL OPERATION	18-19	3 MINUTE PLUS	41
TIME COOKING.....	18-19	CLEANING AND CARE	42-44
TO SET POWER LEVEL.....	18-19	NON-COOKTOP SURFACES	42
SENSOR SETTINGS.....	20-25	COOKTOP	42-43
REHEAT.....	20-21	MICROWAVE DRAWER	43
POPCORN	21	OVEN	43
AUTOMATIC COOKING	22-25	REMOVE AND REPLACE OVEN DOOR	43
DEFROST	26	OVEN RACKS.....	44
MANUAL DEFROST	26	BROILER PAN, GRID AND ROAST/BROIL RACK.....	44
OTHER CONVENIENT FEATURES	27-28	OVEN LIGHT REPLACEMENT	44
KEEP WARM.....	27	BEFORE YOU CALL FOR SERVICE	45-46
		AUTO-TOUCH GUIDE	47-BACK COVER

CUSTOMER ASSISTANCE

To aid in reporting this electric range, please record below the model number and serial number located on the unit. We also suggest you record all the information listed and retain for future reference.

MODEL NUMBER _____ SERIAL NUMBER _____

DATE OF PURCHASE _____ / _____ / _____

DEALER _____ TELEPHONE _____

SERVICER _____ TELEPHONE _____

TO PHONE:

DIAL **1-800-BE-SHARP (237-4277)** for:
SERVICE (for your nearest Sharp Authorized Servicer)
PARTS (for your authorized parts distributor)
ADDITIONAL CUSTOMER INFORMATION
ADDITIONAL OVEN RACKS

TO WRITE:

Sharp Electronics Corporation
Customer Assistance Center
1300 Naperville Drive
Romeoville, IL 60446-1091

Please provide the following information when you write or call: model number, serial number, date of purchase, your complete mailing address (including zip code), your daytime telephone number (including area code) and description of the problem.

TO ACCESS INTERNET: www.sharppusa.com

PRECAUTIONS TO AVOID POSSIBLE EXPOSURE TO EXCESSIVE MICROWAVE ENERGY

- (a)** Do not attempt to operate this oven with the door open since open-door operation can result in harmful exposure to microwave energy. It is important not to defeat or tamper with the safety interlocks.
- (b)** Do not place any object between the oven front face and the door or allow soil or cleaner residue to accumulate on sealing surfaces.
- (c)** Do not operate the oven if it is damaged. It is particularly important that the oven door close properly and that there is no damage to the: (1) door (bent), (2) hinges and latches (broken or loosened), (3) door seals and sealing surfaces.
- (d)** The oven should not be adjusted or repaired by anyone except properly qualified service personnel.

These precautions apply to the Microwave Drawer only.

CONSUMER LIMITED WARRANTY

SHARP ELECTRONICS CORPORATION warrants to the first consumer purchaser that this Sharp brand product (the “Product”), when shipped in its original container, will be free from defective workmanship and materials, and agrees that it will, at its option, either repair the defect or replace the defective Product or part thereof with a new or remanufactured equivalent at no charge to the purchaser for parts or labor for the period(s) set forth below.

This warranty does not apply to any appearance items of the Product nor to the additional excluded item(s) set forth below nor to any Product the exterior of which has been damaged or defaced, which has been subjected to misuse, abnormal service or handling, or which has been altered or modified in design or construction.

In order to enforce the rights under this limited warranty, the purchaser should follow the steps set forth below and provide proof of purchase to the servicer.

The limited warranty described herein is in addition to whatever implied warranties may be granted to purchasers by law. ALL IMPLIED WARRANTIES INCLUDING THE WARRANTIES OF MERCHANTABILITY AND FITNESS FOR USE ARE LIMITED TO THE PERIOD(S) FROM THE DATE OF PURCHASE SET FORTH BELOW. Some states do not allow limitations on how long an implied warranty lasts, so the above limitation may not apply to you.

Neither the sales personnel of the seller nor any other person is authorized to make any warranties other than those described herein, or to extend the duration of any warranties beyond the time period described above on behalf of Sharp.

The warranties described herein shall be the sole and exclusive warranties granted by Sharp and shall be the sole and exclusive remedy available to the purchaser. Correction of defects, in the manner and for the period of time described herein, shall constitute complete fulfillment of all liabilities and responsibilities of Sharp to the purchaser with respect to the Product, and shall constitute full satisfaction of all claims, whether based on contract, negligence, strict liability or otherwise. In no event shall Sharp be liable, or in any way responsible, for any damages or defects in the Product which were caused by repairs or attempted repairs performed by anyone other than an authorized servicer. Nor shall Sharp be liable or in any way responsible for any incident or consequential economic or property damage. Some states do not allow the exclusion of incidental or consequential damages, so the above exclusion may not apply to you.

THIS WARRANTY GIVES YOU SPECIFIC LEGAL RIGHTS. YOU MAY ALSO HAVE OTHER RIGHTS WHICH VARY FROM STATE TO STATE.

Your product model number & description	KB-3425J or KB-4425J Home Use Electric Range with Microwave Drawer. (Be sure to have this information available when you need service for your Product.)
Warranty period for this product:	One (1) year parts and labor including in-home service. The warranty period continues for an additional four (4) years, for a total of five (5) years, with respect to the glass ceramic cooktop, radiant surface units and magnetron tube in the Product for parts only; labor and service are not provided free of charge for this additional period.
Additional item(s) excluded from warranty coverage (if any):	Non-functional accessories and light bulbs.
Where to obtain service:	From a Sharp Authorized Servicer located in the United States. To find the location of the nearest Sharp Authorized Servicer, call Sharp toll free at 1-800-BE-SHARP (1-800-237-4277).
What to do to obtain service:	In-home service is provided for one year from date of purchase. In-home service can be arranged by calling 1-800-BE-SHARP. Be sure to have Proof of Purchase available.

TO OBTAIN SUPPLY, ACCESSORY OR PRODUCT INFORMATION, CALL 1-800-BE-SHARP or visit www.sharpsusa.com. SAVE THE PROOF OF PURCHASE AS IT IS NEEDED SHOULD YOUR OVEN EVER REQUIRE WARRANTY SERVICE.

PRODUCT INFORMATION CARD

The Product Information Card should be completed within ten days of purchase and returned. We will keep it on file and help you access the information if needed. This will also enable us to contact you in the unlikely event that any adjustments or modifications are ever required for your range.

IMPORTANT SAFETY INSTRUCTIONS

READ ALL INSTRUCTIONS BEFORE USING

IMPORTANT SAFETY NOTICE AND WARNING

The California Safe Drinking Water and Toxic Enforcement Act of 1986 (Proposition 65) requires the Governor of California to publish a list of substances known to the State of California to cause cancer or reproductive harm and requires businesses to warn customer of potential exposures to such substances.

Users of this appliance are hereby warned that when it is engaged in the self-clean cycle, there may be low level exposure to carbon monoxide, a chemical known to the State of California to cause reproductive harm. Exposure can be minimized by properly venting the oven to the outdoors during the self-clean cycle, by opening a window and/or door in the room where the appliance is located.



WARNING All ranges can tip and injury could result. To reduce the risk of tipping of the appliance from abnormal usage by excessive loading of the oven door, the appliance must be secured to wall and floor by installing the Anti-Tip device supplied. If it is not, there is a possible risk of the range tipping over and causing injury if you or a child stand, sit or lean on an open door. Please refer to the Anti-Tip device information in the Installation Manual.



To check if the device is properly installed and engaged, look underneath the range with a flashlight to make sure one of the rear leveling legs is properly engaged in the bracket slot. The Anti-Tip device secures the rear leveling leg to the floor when properly engaged. You should check this anytime the range has been moved.

SAFETY PRECAUTIONS

When using electrical appliances, basic safety precautions should be followed, including the following:

- 1 Use this appliance only for its intended purpose as described in this manual.
- 2 Be sure your appliance is properly installed and grounded by a qualified technician in accordance with the provided installation instructions.
- 3 Never use appliance for warming or heating the room.
- 4 Children should not be left alone or unattended in area where appliance is in use. They should never be allowed to sit or stand on any part of the appliance.
- 5 Never wear loose-fitting or hanging garments while using the appliance. Be careful when reaching for items stored over the range. Flammable material could be ignited if brought in contact with hot surface units or heating elements and may cause severe burns.
- 6 Do not repair or replace any part of appliance unless specifically recommended in this manual. All other servicing should be referred to a qualified technician.
- 7 Do not store flammable materials in an oven, Microwave Drawer or near surface units. Do not store or use

combustible materials, gasoline or other flammable vapors and liquids in the vicinity of this appliance.

- 8 Do not use water on grease fires. Smother a flame or use a dry chemical or foam-type extinguisher. Flaming grease outside a pan can be put out by covering it with baking soda or, if available, by a multi-purpose dry chemical or foam-type fire extinguisher.
- 9 Use only dry potholders - a moist or damp potholder on hot surfaces may result in burns from steam. Do not let potholders touch hot surfaces, radiant surface units or heating elements. Do not use a towel or other bulky cloth.
- 10 **CAUTION** Do not store items of interest to children in cabinets above a range or on the backsplash of a range. Children climbing on the range to reach items could be seriously injured.
- 11 Do not touch the surface units, heating elements or the interior surface of the oven. These surfaces may be hot even though they are dark in color. These surfaces may become hot enough to cause burns. During and after use, do not touch or let clothing or other flammable materials contact surface units, heating elements or interior surfaces of oven until they have had sufficient time to cool. Other potentially hot surfaces include: cooktop, areas facing the cooktop, oven vent opening, surfaces near the vent opening, oven door and window and area around the door.
- 12 Have the installer show you the location of the circuit breaker or fuse. Mark it for easy reference.
- 13 Before performing any service, disconnect the range power supply at the household distribution panel by removing the fuse or switching off the circuit breaker.
- 14 Do not allow anyone to climb, stand or hang on the door, Microwave Drawer or cooktop. They could damage the range and even tip it over, causing severe personal injury.
- 15 Teach children not to play with the controls or any other part of the range.
- 16 Always keep wooden and plastic utensils and canned food a safe distance from your range.
- 17 Always keep combustible wall coverings, curtains or drapes a safe distance from your range.

RADIANT SURFACE UNITS

- 1 Use proper pan size — this appliance has different size surface units. Select utensils having flat bottoms large enough to cover the surface unit heating element. The use of undersized utensils will expose a portion of surface unit heating element to direct contact and may result in ignition of clothing. Proper relationship of utensils to heating element will also improve efficiency.
- 2 Never leave surface units unattended at high heat settings. Boilovers cause smoking and greasy spillovers that may catch on fire.
- 3 Only certain types of glass, glass/ceramic, ceramic,

IMPORTANT SAFETY INSTRUCTIONS

earthware or other glazed utensils are suitable for cooktop service without breaking due to the sudden change in temperature.

- 4 To reduce the risk of burns, ignition of flammable materials and spillage due to unintentional contact with utensils, the handle of a utensil should be positioned so that it is turned inward and does not extend over adjacent surface units.
- 5 Do not cook on broken cooktop. If cooktop should break, cleaning solutions and spillovers may penetrate the broken cooktop and create a risk of electric shock. Contact a qualified technician immediately.
- 6 Clean cooktop with caution. If a wet sponge or cloth is used to wipe spills on a hot surface unit, be careful to avoid steam burn. Some cleaners can produce noxious fumes if applied to a hot surface. Please see cleaning the glass cooktop section.
- 7 Clean ventilating hoods frequently. Grease should not be allowed to accumulate on hood or filter.
- 8 When flaming foods under the hood, turn the fan on.
- 9 Deep fat fryers - use extreme caution when moving the grease kettle or disposing of hot grease.
- 10 Always turn the surface units off before removing cookware.
- 11 Keep an eye on foods being fried at high or medium high heat settings.
- 12 Food for frying should be as dry as possible. Frost on frozen foods or moisture on fresh foods can cause hot fat to bubble up and over the sides of the pan.
- 13 Use little fat for effective shallow or deep fat frying. Filling the pan too full of fat can cause spillovers when food is added.
If a combination of oils or fats will be used in frying, stir together before heating or as fats melt slowly.
- 14 Always heat fat slowly and watch as it heats.
- 15 Use a deep fat thermometer whenever possible to prevent heating fat beyond the smoking point.
- 16 Avoid scratching the glass cooktop. The cooktop can be scratched with items such as sharp instruments, rings or other jewelry and rivets on clothing.
- 17 Large scratches or impacts to glass doors or cooktop can lead to broken or shattered glass.
- 18 Never use the glass cooktop surface as cutting board.
- 19 Do not place or store items that can melt or catch fire on the glass cooktop, even when it is not being used.
- 20 Be careful when placing spoons or other stirring utensils on glass cooktop surface when it is in use. They may become hot and could cause burns.

MICROWAVE DRAWER

When using the Microwave Drawer, basic safety precautions should be followed, including the following:

WARNING *To reduce the risk of burns, electric shock, fire, injury to persons or exposure to excessive microwave energy:*

- 1 Read all instructions before using the appliance.
- 2 Read and follow the specific “PRECAUTIONS TO AVOID POSSIBLE EXPOSURE TO EXCESSIVE MICROWAVE ENERGY” on page 3.
- 3 This appliance must be properly grounded. See Installation Instructions for grounding instructions.
- 4 Install or locate this appliance only in accordance with the provided Installation Manual.
- 5 Some products such as whole eggs and sealed containers - for example, closed glass jars— are able to explode and should not be heated in the Microwave Drawer.
- 6 Use this appliance only for its intended use as described in this manual. Do not use corrosive chemicals or vapors in this appliance. This Microwave Drawer is specifically designed to heat, cook or dry food. It is not designed for industrial or laboratory use.
- 7 As with any appliance, close supervision is necessary when used by children.
- 8 Do not operate this appliance if it has a damaged cord or plug, if it is not working properly or if it has been damaged or dropped.
- 9 This appliance should be serviced only by qualified service personnel. Contact nearest Sharp Authorized Servicer for examination, repair or adjustment.
- 10 Do not cover or block any openings on the appliance.
- 11 Do not store or use this appliance outdoors. Do not use this product near water— for example, in a wet basement, near a swimming pool or similar locations.
- 12 Do not immerse cord or plug in water. Keep cord away from heated surfaces.
- 13 Do not climb or sit on the Microwave Drawer. The range could tip and cause injuries to persons.
- 14 Be sure that fingers or other objects or materials are not around the Microwave Drawer opening when the Microwave Drawer is closed.
- 15 Do not put fingers or clothes around the drawer guides when the Microwave Drawer is opened or closed. They could be caught in the guides when the Microwave Drawer is closed.
- 16 Be sure that the food and container are shorter than the Microwave Drawer before closing it. You can refer to the height of the side walls of the Microwave Drawer.
- 17 When cleaning Microwave Drawer sealing surfaces that come together on closing the drawer, use only mild, nonabrasive soaps or detergents applied with a sponge or soft cloth. See cleaning instructions on page 43.
- 18 To reduce the risk of fire in the Microwave Drawer cavity:
 - a Do not overcook food. Carefully attend appliance when paper, plastic or other combustible materials are placed inside the Microwave Drawer to facilitate cooking.
 - b Remove wire twist-ties from paper or plastic bags before placing bag in Microwave Drawer.
 - c If materials inside the Microwave Drawer ignite, keep Microwave Drawer door closed, turn microwave off and shut off power at the fuse or circuit breaker panel.

IMPORTANT SAFETY INSTRUCTIONS

- d** Do not use the Microwave Drawer for storage purposes. Do not leave paper products, cooking utensils, or food in the Microwave Drawer when not in use.
- 19** Liquids, such as water, coffee or tea are able to be overheated beyond the boiling point without appearing to be boiling due to surface tension of the liquid. Visible bubbling or boiling when the container is removed from the Microwave Drawer is not always present. **THIS COULD RESULT IN VERY HOT LIQUIDS SUDDENLY BOILING OVER WHEN A SPOON OR OTHER UTENSIL IS INSERTED INTO THE LIQUID.**
- To reduce the risk of injury to persons:
- a** Do not overheat the liquid.
 - b** Stir the liquid both before and halfway through heating it.
 - c** Do not use straight-sided containers with narrow necks. Use a wide-mouthed container.
 - d** After heating, allow the container to stand in the Microwave Drawer at least for 20 seconds before removing the container.
 - e** Use extreme care when inserting a spoon or other utensil into the container.

OVEN

- 1** Use care when opening door — let hot air or steam escape before removing or replacing food.
- 2** Do not heat unopened food containers. Build-up of pressure may cause container to burst and result in injury.
- 3** Keep oven vent unobstructed.
- 4** Always place oven racks in desired locations while oven is cool. If rack must be moved while oven is hot, do not let potholder contact hot heating element.

- 5** Do not use aluminum foil to line oven bottom, as use may result in a risk of electric shock or fire.
- 6** Keep the oven free from grease buildup.
- 7** When using cooking or roasting bags in the oven, follow the manufacturer's directions.
- 8** Pulling out the rack to the stop-lock is a convenience in lifting heavy foods. It is also a precaution against burns from touching hot surfaces of the door or oven walls.
- 9** Do not use the oven to dry newspapers. If overheated, they can catch fire.
- 10** Do not use the oven for a storage area. Items stored in oven can ignite.
- 11** Do not leave paper products, cooking utensils or food in the oven when not in use.

SELF-CLEANING OVEN

- 1** Do not clean door gasket. The door gasket is essential for a good seal. Care should be taken not to rub, damage or move the gasket.
- 2** Do not use oven cleaners. No commercial oven cleaner or oven liner protective coating of any kind should be used in or around any part of the oven. Residue from oven cleaners will damage the inside of the oven when the self-clean cycle is used.
- 3** Clean only parts listed in this manual.
- 4** Before self-cleaning the oven, remove broiler pan, racks, and other utensils.
- 5** If the self-cleaning mode malfunctions, turn the oven off and disconnect the power supply. Have it serviced by a qualified technician.

SAVE THESE INSTRUCTIONS

UNPACKING AND EXAMINING YOUR RANGE

- 1** Remove all packing materials from inside the Microwave Drawer and the oven cavity. **DO NOT REMOVE THE WAVEGUIDE COVER**, which is located on the top of the Microwave Drawer area.
- 2** Remove the feature sticker, if there is one, from the outside of the Microwave Drawer. Check the drawer for any damage, such as misaligned or bent drawer, damaged drawer seals and sealing surfaces, broken or loose Microwave Drawer guides and dents inside the cavity or on the front side of the drawer. If there is any damage, do not operate the Microwave Drawer and contact your dealer or a SHARP AUTHORIZED SERVICER.

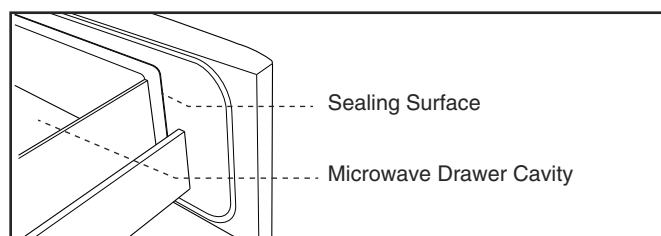
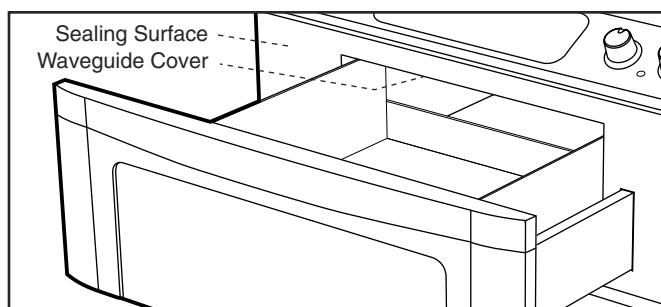

PARTS NAME

ELECTRIC RANGE WITH MICROWAVE DRAWER

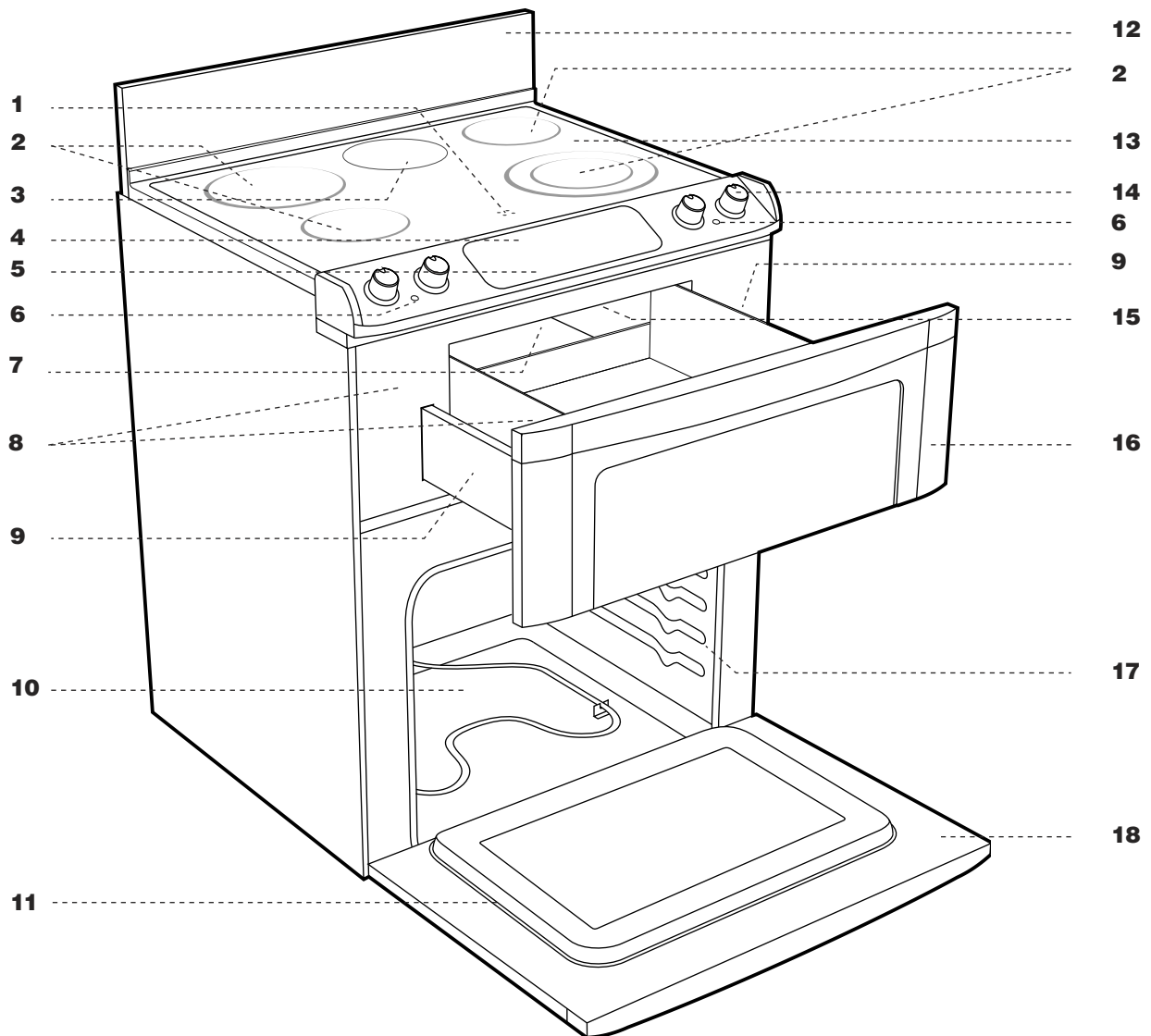

- 1** Hot surface indicator
- 2** Radiant surface units
- 3** Cooktop Warm Zone
- 4** Control panel
- 5** Cooktop Warm indicator
- 6** Cooktop-on indicator
- 7** Waveguide cover
DO NOT REMOVE
- 8** Drawer sealing surfaces
- 9** Microwave Drawer guides

- 10** Oven
- 11** Gasket
- 12** Adjustable backsplash (model KB-3425J only)
- 13** Glass ceramic cooktop
- 14** Control knobs
- 15** Drawer light
- 16** Microwave Drawer™
- 17** Rack supports
- 18** Oven door

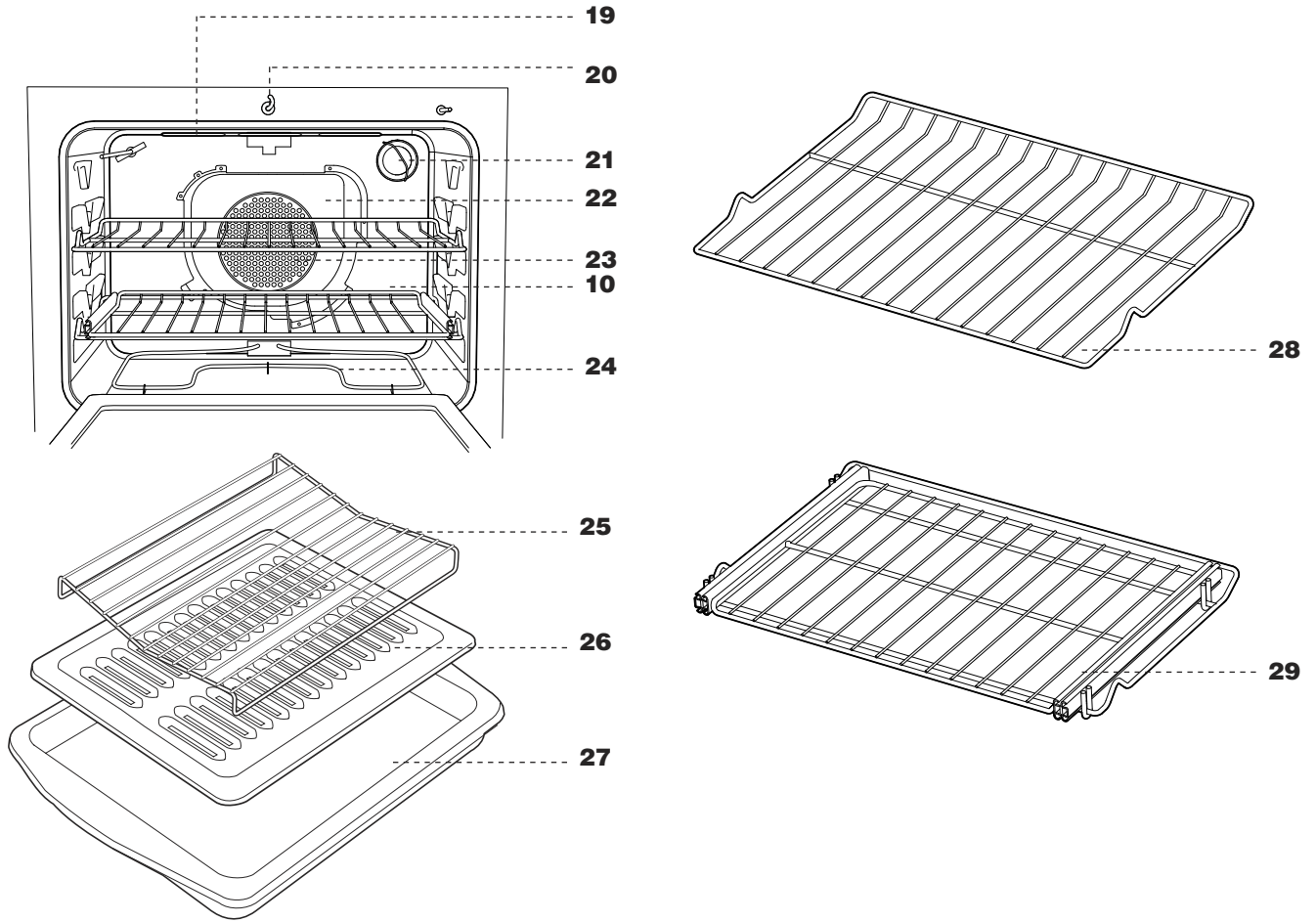

- 19** Top heating element
- 20** Oven door lock
- 21** Oven light
- 22** Convection fan cover
- 23** Rear heater
- 24** Bottom heating element

- 25** Roast/Broil rack
- 26** Broiler pan grid
- 27** Broiler pan
- 28** Standard rack (1)
- 29** EZ Pull oven rack (2)

**ADJUSTABLE HEIGHT BACKSPLASH
(FOR MODEL KB-3425J ONLY)**

The range backsplash is adjustable so that you can customize it for your particular kitchen situation. The height can be adjusted from the low position (6-inches high) to the highest position (12-inches high) in one-inch increments. See Installation Instructions for directions (packed separately). The height of the backsplash should be adjusted before the unit is moved into place.

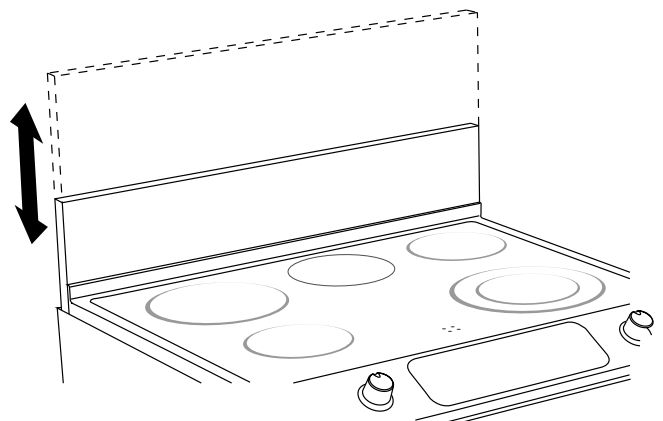

PARTS NAME

EZ PULL OVEN RACK INSTRUCTIONS

The EZ Pull Oven Racks make it easy and convenient to place food in and remove food from the lower oven. They are ideal for heavier foods or dishes. While the EZ Pull Oven Racks can be used in any position, you will find them most useful when placed in lower positions.

IMPORTANT Do not leave the EZ Pull Oven Racks in oven during self-cleaning cycle.

Figure 1

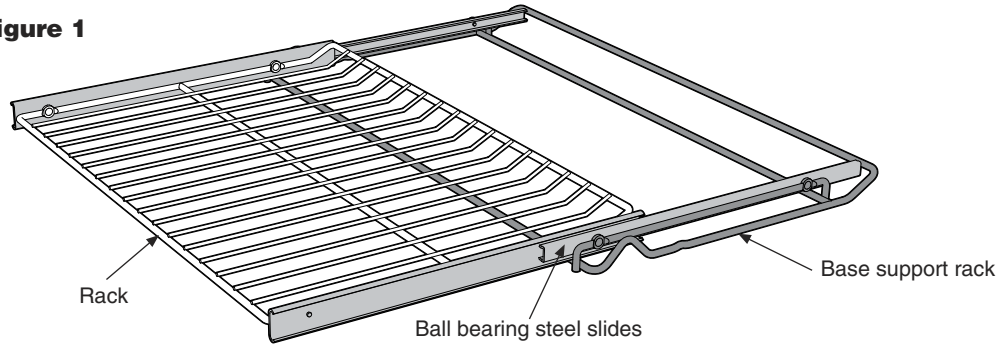

Figure 2

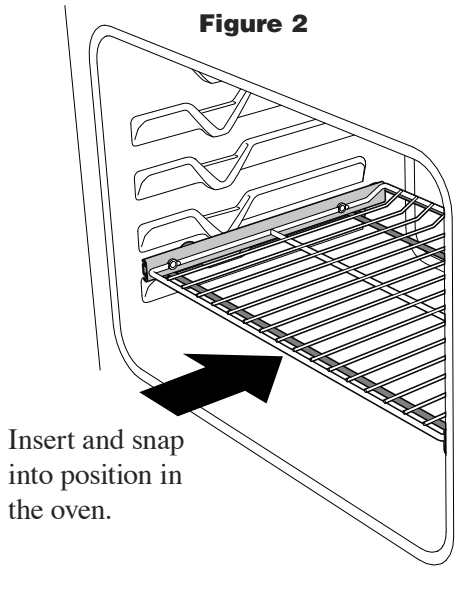

Figure 3

IMPORTANT
Base support rack remains snapped in position inside the oven.

Shelf shown in extended position.

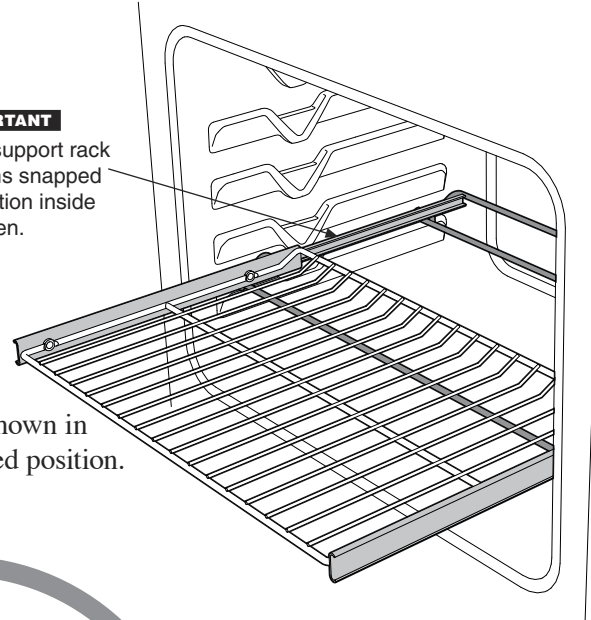
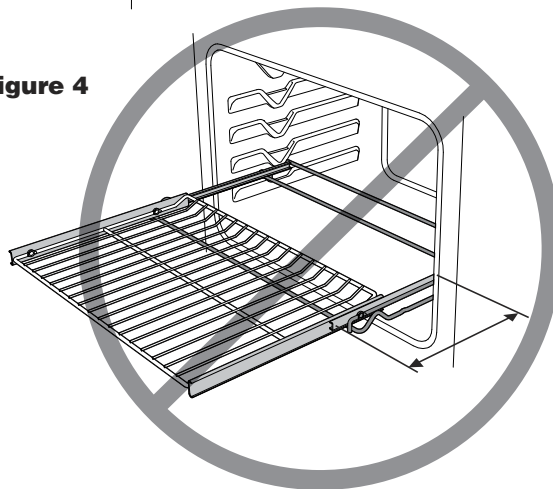

Figure 4



DO NOT extend base support rack beyond oven opening during use as shown in Figure 4.

NOTE: IT IS IMPORTANT THAT THE RANGE BE LEVEL. CHECK INSTALLATION INSTRUCTIONS.

GLASS CERAMIC COOKTOP

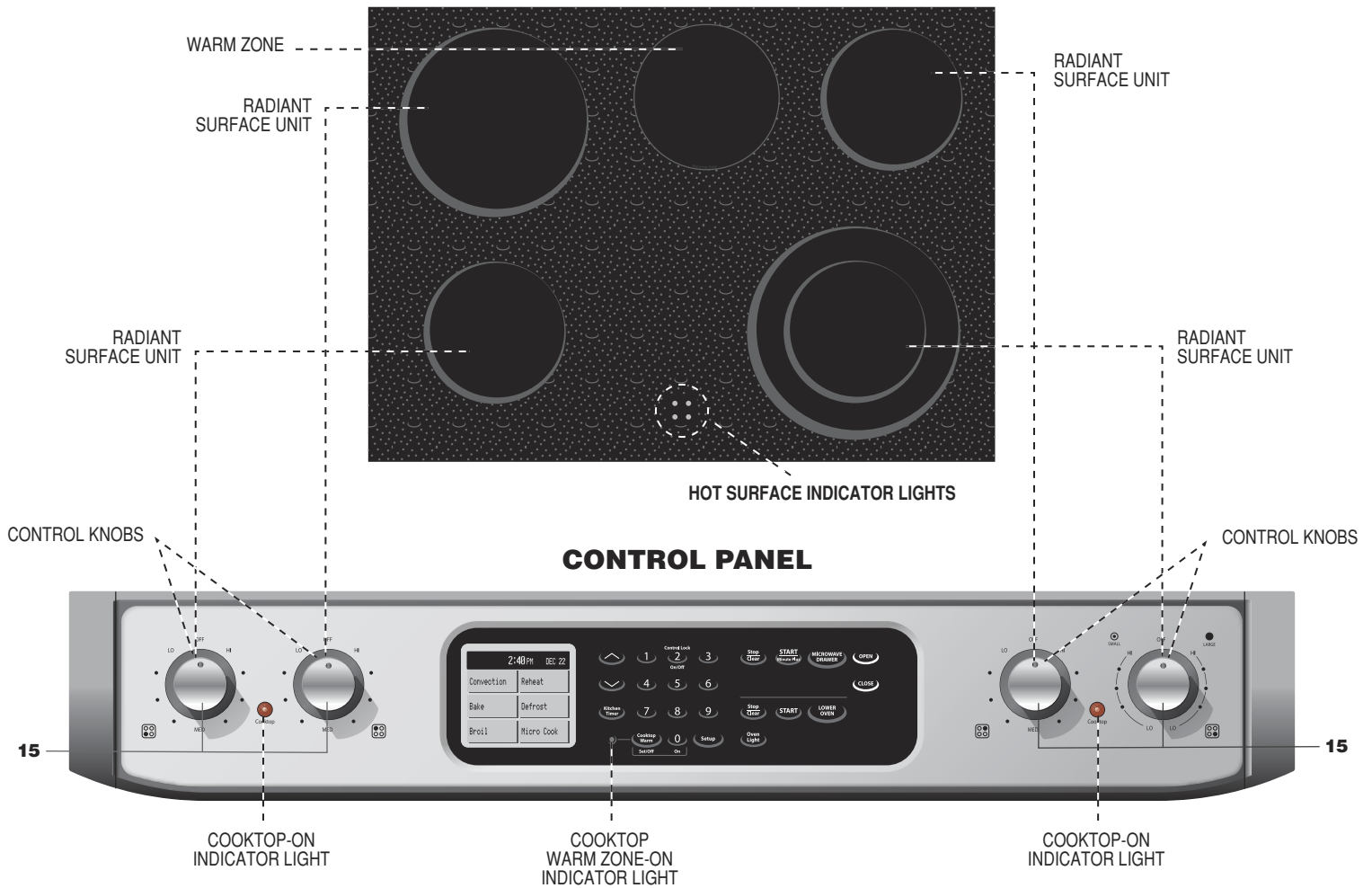

KEYSHEET

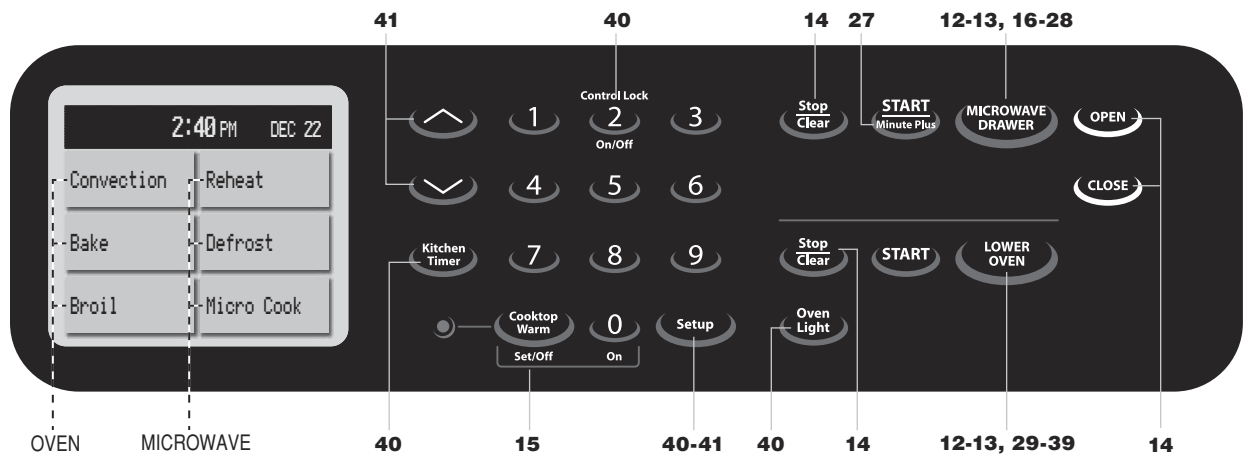

Numbers next to the keysheet illustration indicate pages on which there are feature descriptions and usage information.

When you wish to use both the Microwave Drawer and the Oven, complete one setting and touch **START** before programming the other setting.

INTRODUCTION TO TOUCHSCREEN

This Sharp Insight Range features an LCD Touchscreen that is designed to make operation easy by providing step-by-step instructions right on the active touchscreen display.

After the time of day and date are set (instructions on next page), the “Home Screen” will appear. Notice that the Lower Oven operation pads appear on the left side of the touchscreen and the Microwave options are on the right.

TOUCHSCREEN DISPLAY

HOME SCREEN



To use the Lower Oven for Convection cooking, conventional baking or conventional broiling, simply touch the appropriate pad and follow the directions in the display. For more options, touch the **Lower Oven** pad toward the right-hand side

of the control panel. When you touch this **Lower Oven** pad, the Lower Oven “Home Page” will appear.

LOWER OVEN HOME PAGE

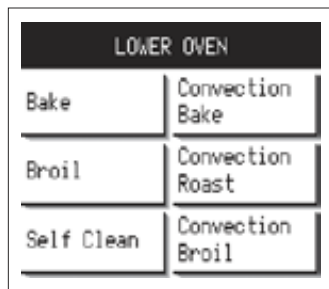

You can see that there are more choices on this screen, including Self-Clean. Keep in mind that you can access Convection Cooking, Bake and Broil from either the “Home Screen” or the “Lower Oven Home Page”.

MICROWAVE DRAWER HOME PAGE

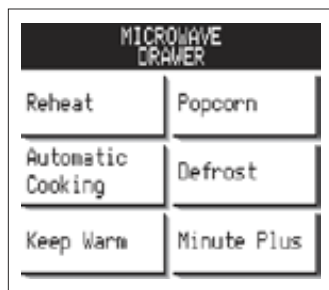

To use the Microwave Drawer, you can select one of the options on the right-hand side of the “Home Screen” to Reheat, Defrost or Micro Cook (automatic cooking). For more options, touch the **Microwave Drawer** pad toward the right side of

the control panel or simply open the **Microwave Drawer** by touching the **OPEN** pad. The Microwave Drawer Home Page will appear.

The “Microwave Drawer Home Page” gives you six options: Reheat, Defrost and Automatic Cooking, plus Popcorn, Minute Plus and Keep Warm. By simply touching one of these pads, you will see more options and specific directions. All of these settings are automatic, but microwave cooking times and power levels can be set manually, as well (see page 18-19).

As you use the touchscreen, you will see that regardless of where you start—from the Home Screen, from the Lower Oven Home Page or from the Microwave Drawer Home Page—you will get to the same options and information.

Just read the information on the touchscreen and follow the directions. You’ll soon find that selecting from the various cooking options is easy and fun—and the guesswork has been eliminated. Please refer to detailed programming information on the following pages for specific features.

USING BOTH OVENS SIMULTANEOUSLY

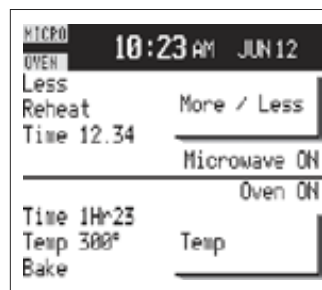

You can use the Lower Oven and the Microwave Drawer at the same time. When both ovens are in operation, the touchscreen display will be split. The Microwave Drawer program and countdown will be displayed in the upper part of the touch-

screen and the Oven program will appear in the lower portion.

If the Lower Oven is **ON** and you want to use the Microwave Drawer, simply touch the **Microwave Drawer** pad. The Lower Oven program will disappear and the touchscreen will display microwave cooking options. If you want to cook by time and power level (you do not want to use the automatic settings), you can now program the microwave manually (see page 18). Once you have finished programming the microwave and touched **START**, the display will split so that you can keep track of both functions.

If you are using the Microwave Drawer and wish to use the Lower Oven, touch the **Lower Oven** pad. Proceed to set the Lower Oven, then touch **START**. The display will be split to show both functions.

BEFORE OPERATING

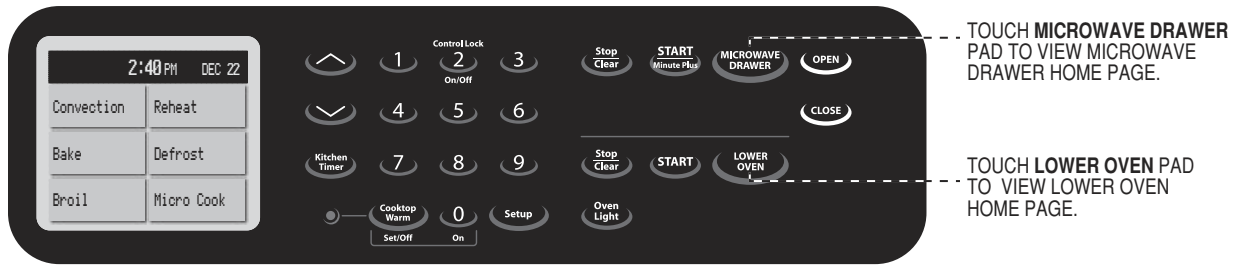

TOUCH **MICROWAVE DRAWER** PAD TO VIEW MICROWAVE DRAWER HOME PAGE.

TOUCH **LOWER OVEN** PAD TO VIEW LOWER OVEN HOME PAGE.

Before operating your new range make sure you read and understand this operation manual completely.

- Before the range can be used, follow these steps:

- 1** Plug in the range. The display will read, “Please wait 30 seconds”. After 30 seconds, you can select either **Video Demo** or **Set Clock**.
- 2** Touch **Set Clock** and follow the instructions below.

Note:

- If no choice is made for 30 seconds, the Video Demo will begin automatically. To cancel the Video Demo, Touch the **Stop/Clear** pad and the display will return to the Home Screen. To set the clock, touch the **Setup** pad, touch **Clock** and follow the directions on the touchscreen.

TO SET DATE AND TIME

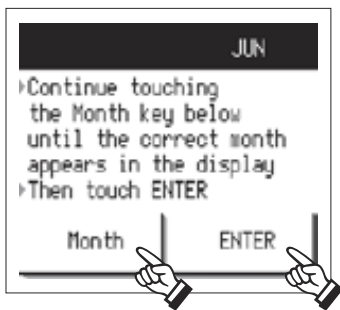

- 1** After touching **Set Clock** or **Clock**, enter the correct month by touching **Month** repeatedly. The month appears in the banner at the top of the display. When set for the correct month, touch **ENTER**.

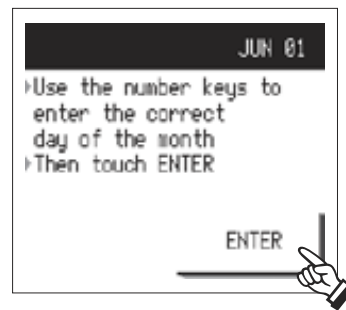

- 2** Enter the date by touching the number pads on the control panel. Example: for June 1, touch **0****1**. Check the date in the banner, then touch **ENTER**.

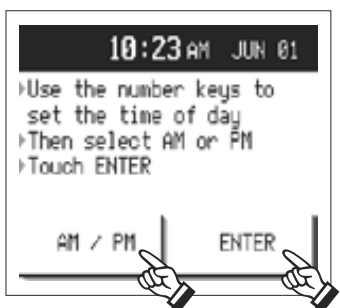

- 3** Enter the time by touching the number pads. Select **AM/PM** and then touch **ENTER**.



- 4** The month, date and time will appear in the banner. The display will return to the Home Screen.

Note:

- If you make a mistake while setting the clock, touch **Stop/Clear** pad. The Home Screen will appear. To set clock again, touch **Setup** pad on the control panel. Then touch **Clock** and follow the directions.
- If you want to change the setting of the time of day, Touch **Setup** pad and follow the directions.
- If the electrical power supply to your range should be interrupted, the screen will intermittently show Video Demo or Set Clock after the power is reinstated. If this occurs during cooking, the program will be erased. Simply touch **Set Clock** and follow the directions.

BEFORE OPERATING

STOP/CLEAR

Touch the **Stop/Clear** pad to:

- 1 Erase if you make a mistake during programming.
- 2 Stop the Oven or Microwave Drawer temporarily during timed cooking.
- 3 To cancel a program during cooking, touch twice for timed cooking.

COOKTOP USE

INFORMATION YOU NEED TO KNOW

ABOUT THE COOKTOP

- **Glass ceramic cooktop** - Make sure the surface and the pan bottom are clean before turning on. Do not use the cooktop if the glass is broken or if metal melts on it.
- **Radiant surface units** - The radiant surface heating units are beneath the smooth glass ceramic cooktop. The design on the cooktop outlines the area of the surface unit underneath. When the cooktop is on, the cooktop-on indicator, next to the surface cooking control knob, comes on even if the cooktop unit doesn't look red. The areas around the units may become hot enough to cause burns.
- **Hot surface indicator** - An indicator light, on the cooktop, comes on when the surface unit is turned on and the cooktop temperature increases. The indicator will remain on until the surface has cooled below 150°F even after the unit is turned off.
- **Temperature limiter** - The radiant surface units have a temperature limiter that allows the unit to cycle on and off, even at the HI setting. It protects the glass ceramic cooktop from damage. Cycling at the HI setting can occur when improper cookware is used.

Note:

- Never leave any items on the cooktop. Hot units may ignite flammable items, melt or soften plastics or increase pressure in closed containers causing them to burst.
- Don't store heavy items above the cooktop as they can cause damage if they drop on to the cooktop.
- Never cook directly on the cooktop. Always use cookware.

OPEN OR CLOSE MICROWAVE DRAWER

ALWAYS touch the **OPEN** or **CLOSE** pad on the control panel to open or close the Microwave Drawer.

Do not push or pull the Microwave Drawer by hand, except in case of emergency such as a power failure.

ABOUT COOKING UTENSILS

For best results and energy conservation, choose cooking utensils as below.

- **Bottom of pan** - Pans should have flat bottoms that make good contact with the entire surface unit. Check for flatness by using a straight edge. Pans with curved or warped bottoms are not recommended.
- **Size of pan** - Pan size should match the amount of food and the size of the surface unit. Do not use canners or frypans that exceed the width of the radiant surface units.
- **Material of pan** - Always use a utensil for its intended purpose. Follow manufacturer's instructions. Some utensils were not made to be used on the cooktop.
- **Position of pan** - Always place the pan in the center of the surface unit you are using.
- **Wok Cooking** - Only a flat-bottomed wok is recommended. Do not use round-bottom wok or a wok with a support ring.

Note:

- Do not slide cookware across the cooktop surface because it can scratch the glass or may leave marks which need to be removed promptly.
- Never allow a pan to boil dry. This could damage the pan and the countertop.
- Do not use aluminum foil on the cooktop surface.
- Do not use cooktop as a cutting board.

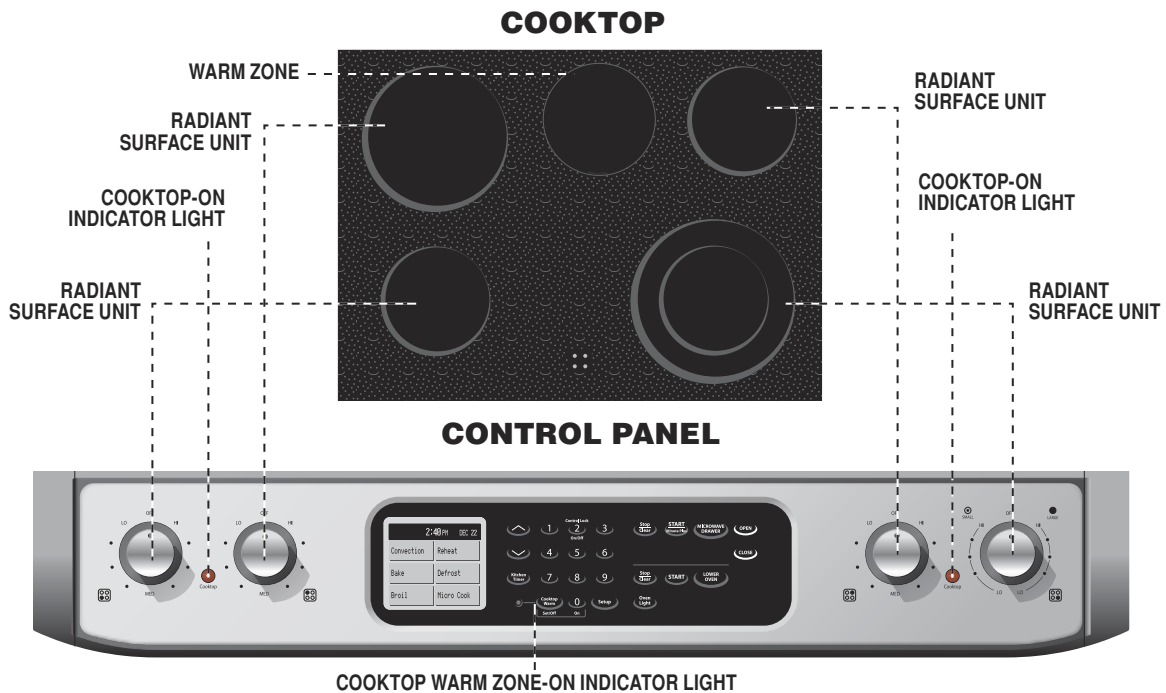

RADIANT SURFACE UNITS

Surface units are turned on and adjusted using the control knobs.

HOW TO SET SINGLE SURFACE UNIT

- 1 Place correctly sized cookware on the radiant surface unit.
- 2 Push the knob in and turn in either direction to the desired heat setting.
- 3 When cooking is completed, turn the knob to OFF. Remove pan.

HOW TO SET DUAL SURFACE UNIT

The right front surface unit has 2 cooking sizes so that you can choose either to match the diameter of the cookware you are using.

- 1 Place correct size cookware on the radiant surface unit.
- 2 To use the small surface unit, push the knob in and turn it to the left, counter clockwise.

To use the large surface unit, push the knob in and turn it to the right, clockwise.

- 3 When cooking is completed, turn the knob to OFF. Remove pan.

Note for surface unit: A hot surface indicator light in the center of the cooktop will glow when a radiant unit is turned on. It will remain on until the surface is cooled to about 150°F. Be sure the knob is turned to OFF when you have finished cooking.

The glass ceramic cooktop retains heat after the radiant surface units have been turned to OFF. If possible, turn the units off and allow foods to finish cooking with the retained heat. It may be necessary to remove the pan from the unit to prevent further cooking, also.

SUGGESTED HEAT SETTINGS

Setting	Type of cooking
High	Bring liquid to a boil. Always reduce setting to a lower heat when liquids begin to boil or foods begin to cook.
Medium High	Brown meat, heat oil for deep fat frying or to continue a rapid boil.
Medium	Maintain a slow boil, thicken sauces and gravies
Medium Low	Continue cooking covered foods or steam foods.
Low	Melt or simmer.

Note: The size and type of cookware used will influence the setting needed.

COOKTOP WARM ZONE

The Cooktop Warm Zone will keep hot cooked food at an ideal serving temperature. To turn Cooktop Warm on, touch the **Cooktop Warm** pad, then touch number **0** within 3 seconds. The red indicator will light. To turn the Cooking Warm Zone off, touch the **Cooktop Warm** pad.

CAUTION The Cooktop Warm Zone will not glow red when it is hot, but it does become hot enough to cause burns. Always use oven mittens when removing food from the Warm Zone as cookware and plates will be hot. Use only cookware recommended for top-of-range cooking. Do not use plastic wrap to cover foods. Plastic may melt on to the surface and be very difficult to clean.

MICROWAVE DRAWER COOKING

INFORMATION YOU NEED TO KNOW

ALWAYS have food in the Microwave Drawer when it is on to absorb the microwave energy.

When using the Microwave Drawer at power levels below 100%, you may hear the magnetron cycling on and off. It is normal for the exterior of the Microwave Drawer to be warm to the touch when cooking or reheating.

Condensation is a normal part of microwave cooking. Room humidity and the moisture in food will influence the amount of moisture that condenses in the Microwave Drawer. Generally, covered foods will not cause as much condensation as uncovered ones. Vents between Microwave Drawer and oven must not be blocked.

The Microwave Drawer is for food preparation only. It should not be used to dry clothes or newspapers.

Your Microwave Drawer is rated 1000 watts by using the IEC Test Procedure. In using recipes or package directions, check food a minute or two before the minimum time and add time accordingly.

When opening or closing the Microwave Drawer quickly, food in the Microwave Drawer may be spilled. To clean, please refer to the Cleaning and Care section on page 43.

RADIO OR TV INTERFERENCE

Should there be any interference caused by the Microwave Drawer to your radio or TV, relocate the radio or TV as far away from the range as feasible or check position and signal of receiving antenna.

ABOUT MICROWAVE COOKING

- Arrange food carefully. Place thickest areas towards outside of dish.
- Watch cooking time. Cook for the shortest amount of time indicated and add more as needed. Food severely overcooked can smoke or ignite.
- Cover foods while cooking. Check recipe or cookbook for suggestions: paper towels, wax paper, microwave plastic wrap or a lid. Covers prevent spattering and help foods to cook evenly.
- Shield with small flat pieces of aluminum foil any thin areas of meat or poultry to prevent overcooking before dense, thick areas are cooked thoroughly.
- Stir foods from outside to center of dish once or twice during cooking, if possible.
- Turn foods over once during microwaving to speed cooking of such foods as chicken and hamburgers. Large items like roasts must be turned over at least once.
- Rearrange foods such as meatballs halfway through cooking both from top to bottom and from right to left.
- Add standing time. Remove food from Microwave Drawer and stir, if possible. Cover for standing time which allows the food to finish cooking without overcooking.

- Check for doneness. Look for signs indicating that cooking temperatures have been reached.

Doneness signs include:

- Food steams throughout, not just at edge.
- Center bottom of dish is very hot to the touch.
- Poultry thigh joints move easily.
- Meat and poultry show no pinkness.
- Fish is opaque and flakes easily with a fork.

ABOUT UTENSILS AND COVERINGS

It is not necessary to buy all new cookware. Many pieces already in your kitchen can be used successfully in your new Microwave Drawer. Make sure the utensil does not touch the interior walls during cooking.

Use these utensils for safe microwave cooking and reheating:

- glass ceramic (Pyroceram[®]), such as Corningware[®].
- heat-resistant glass (Pyrex[®])
- microwave-safe plastics
- microwave-safe paper plates
- microwave-safe pottery, stoneware and porcelain
- browning dish (Do not exceed recommended preheating time. Follow manufacturer's directions.)

These items can be used for short time reheating of foods that have little fat or sugar in them:

- wood, straw, wicker

DO NOT USE

- metal pans and bakeware
- dishes with metallic trim
- non-heat-resistant glass
- non-microwave-safe plastics (margarine tubs)
- recycled paper products
- brown paper bags
- food storage bags
- metal twist-ties

Should you wish to check if a dish is safe for microwaving, place the empty dish in the oven and microwave on HIGH for 30 seconds. A dish which becomes very hot should not be used.

The following coverings are ideal:

- Paper towels are good for covering foods for reheating and absorbing fat while cooking bacon.
- Wax paper can be used for cooking and reheating.
- Plastic wrap that is specially marked for microwave use can be used for cooking and reheating. **DO NOT** allow plastic wrap to touch food. Vent so steam can escape.
- Lids that are microwave-safe are a good choice because heat is kept near the food to hasten cooking.
- Oven cooking bags are good for large meats or foods that

MICROWAVE DRAWER COOKING

need tenderizing. DO NOT use metal twist ties. Remember to slit bag so steam can escape.

How to use aluminum foil in your Microwave Drawer:

- Small flat pieces of aluminum foil placed smoothly on the food can be used to shield areas that are either defrosting or cooking too quickly.
- Foil should not come closer than one inch to any surface of the Microwave Drawer.

Should you have questions about utensils or coverings, check a good microwave cookbook or follow recipe suggestions.

ACCESSORIES There are many microwave accessories available for purchase. Evaluate carefully before you purchase so that they meet your needs. A microwave-safe thermometer will assist you in determining correct doneness and assure you that foods have been cooked to safe temperatures. Sharp is not responsible for any damage to the Microwave Drawer when accessories are used.

ABOUT CHILDREN AND THE MICROWAVE

Children below the age of 7 should use the Microwave Drawer with a supervising person very near to them. Between the ages of 7 and 12, the supervising person should be in the same room.

The child must be able to reach the Microwave Drawer comfortably.

At no time should anyone be allowed to lean or swing on the Microwave Drawer.

Children should be taught all safety precautions: use potholders, remove coverings carefully, pay special attention to packages that crisp food because they may be extra hot.

Don't assume that because a child has mastered one cooking skill he/she can cook everything.

Children need to learn that the Microwave Drawer is not a toy. See page 40 for Control Lock feature.

ABOUT SAFETY

- Check foods to see that they are cooked to the United States Department of Agriculture's recommended temperatures.

160°F - For fresh pork, ground meat, boneless white poultry, fish, seafood, egg dishes and frozen prepared food.

165°F - For leftover, ready-to-reheat refrigerated, and deli and carry-out "fresh" food.

170°F - White meat of poultry.

180°F - Dark meat of poultry.

To test for doneness, insert a meat thermometer in a thick or dense area away from fat or bone. NEVER leave the thermometer in the food during cooking, unless it is approved for microwave use.

- ALWAYS use potholders to prevent burns when handling utensils that are in contact with hot food. Enough heat from the food can transfer through utensils to cause skin burns.

- Avoid steam burns by directing steam away from the face and hands. Slowly lift the farthest edge of a dish's covering and carefully open popcorn and oven cooking bags away from the face.
- Stay near the Microwave Drawer while it's in use and check cooking progress frequently so that there is no chance of overcooking food.
- NEVER use the Microwave Drawer for storing cookbooks or other items.
- Select, store and handle food carefully to preserve its high quality and minimize the spread of foodborne bacteria.
- Keep waveguide cover clean. Food residue can cause arcing and/or fires. See page 43.

ABOUT FOODS

FOOD	DO	DON'T
Eggs, sausages, fruits & vegetables	<ul style="list-style-type: none"> • Puncture egg yolks before cooking to prevent "explosion". • Pierce skins of potatoes, apples, squash, hot dogs and sausages so that steam escapes. 	<ul style="list-style-type: none"> • Cook eggs in shells. • Reheat whole eggs. • Dry nuts or seeds in shells.
Popcorn	<ul style="list-style-type: none"> • Use specially bagged popcorn for the microwave. • Listen while popping corn for the popping to slow to 1 or 2 seconds or use special Popcorn pad. 	<ul style="list-style-type: none"> • Pop popcorn in regular brown bags or glass bowls. • Exceed maximum time on popcorn package.
Baby food	<ul style="list-style-type: none"> • Transfer baby food to small dish and heat carefully, stirring often. Check temperature before serving. • Put nipples on bottles after heating and shake thoroughly. "Wrist" test before feeding. 	<ul style="list-style-type: none"> • Heat disposable bottles. • Heat bottles with nipples on. • Heat baby food in original jars.
General	<ul style="list-style-type: none"> • Cut baked goods with filling after heating to release steam and avoid burns. • Stir liquids briskly before and after heating to avoid "eruption". • Use deep bowl, when cooking liquids or cereals, to prevent boilovers. • Food should be shorter than the Microwave Drawer. Please refer to the height of side walls of the drawer. 	<ul style="list-style-type: none"> • Heat or cook in closed glass jars or airtight containers. • Can in the microwave as harmful bacteria may not be destroyed. • Deep fat fry. • Dry wood, gourds, herbs or wet papers.

MICROWAVE DRAWER COOKING



MANUAL OPERATION

TIME COOKING

Your Microwave Drawer can be programmed for 99 minutes 99 seconds (99.99). Always enter the seconds after the minutes, even if they are both zeros.

HIGH POWER COOKING

- Suppose you want to cook for 5 minutes at 100%.

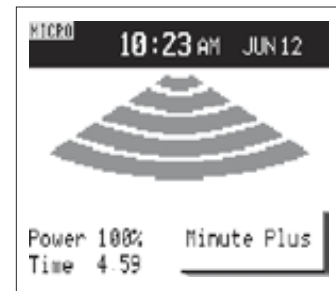
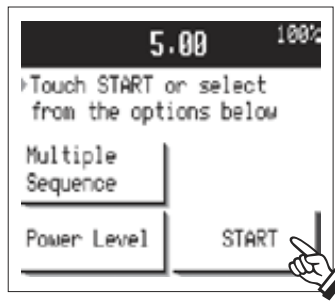

- 1 Enter cooking time by touching number pads **500**.
- 2 Note the top line of the display (the banner). Touch **START**. You can also activate the microwave by touching the **START/Minute Plus** pad on the microwave side of the control panel.
- 3 The display will begin counting down the cooking time. During cooking, the power level will appear in the display.

Note: If the Microwave Drawer is opened or **Stop/Clear** pad is touched once during cooking process, the cooking time in the display automatically stops. The cooking time starts to count down again when the Microwave Drawer is closed and the **START/Minute Plus** pad is touched.

VARIABLE POWER COOKING

There are eleven preset power levels. To change the power level, touch **Power Level** pad after entering the cooking time. Using lower power levels increases the cooking time which is recommended for foods such as cheese, milk and long slow cooking of meats. Consult cookbook or recipes for specific recommendations.

- Suppose you want to cook for 5 minutes at 30% power.

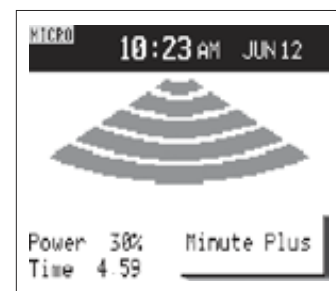
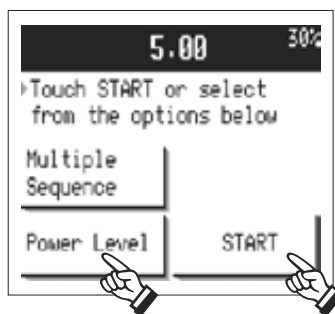

- 1 Enter cooking time by touching number pads **500**.
- 2 Touch **Power Level 7** times for 30%. The top line of the display will show time and chosen power level. Touch **START**.
- 3 The display will begin counting down the cooking time. During cooking, the power level will appear in the display.

MICROWAVE DRAWER COOKING

MULTIPLE SEQUENCE COOKING

The Microwave Drawer can be programmed for up to four automatic cooking sequences, switching from one power level setting to another automatically. Sometimes cooking directions tell you to start on one power level and then change to a different power level. Your oven can do this automatically.

- Suppose you want to cook roast beef for 5 minutes at 70% power and then continue to cook for 30 minutes at 50% power .

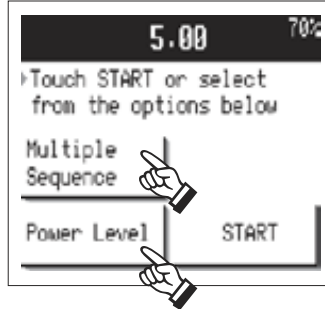
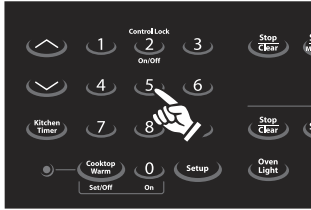

1 Enter cooking time by touching number pads **500**.

2 Touch **Power Level** 3 times to choose 70%. You can omit this step when you set 100% power. Touch **Multiple Sequence**.

3 Note that 100% stage 2 appears in the banner.

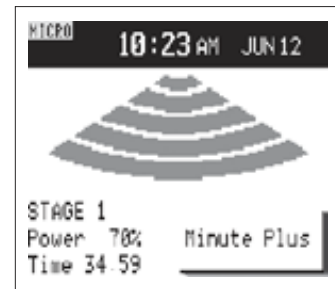
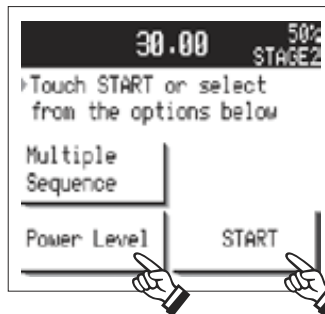

4 Enter second cooking time **3000**.

5 Touch **Power Level** until 50% Stage 2 appears in the display. Touch **START**.

6 The display will begin counting down the total cooking time.

During cooking, the power level will appear in the display. At the end of Stage 1, the microwave will automatically change to Stage 2.

TO SET POWER LEVEL

There are eleven preset power levels.

Using lower power levels increases the cooking time, which is recommended for foods such as cheese, milk and long slow cooking of meats. Consult a microwave cookbook or recipes for specific recommendations.

TOUCH POWER LEVEL PAD NUMBER OF TIMES FOR DESIRED POWER	APPROXIMATE PERCENTAGE OF POWER	COMMON WORDS FOR POWER LEVELS
If Power Level is not touched	100%	High
Power Level x 1	90%	
Power Level x 2	80%	
Power Level x 3	70%	Medium High
Power Level x 4	60%	
Power Level x 5	50%	Medium

TOUCH POWER LEVEL PAD NUMBER OF TIMES FOR DESIRED POWER	APPROXIMATE PERCENTAGE OF POWER	COMMON WORDS FOR POWER LEVELS
Power Level x 6	40%	
Power Level x 7	30%	Med Low / Defrost
Power Level x 8	20%	
Power Level x 9	10%	Low
Power Level x 10	0%	
Power Level x 11	100%	High

MICROWAVE DRAWER COOKING

SENSOR SETTINGS

Sharp's Sensor is a semi-conductor device that detects the vapor (moisture and humidity) emitted from the food as it heats. The sensor adjusts the cooking times and power levels for various foods and quantities.

USING SENSOR SETTINGS:

- 1 After the range is plugged in, wait 2 minutes before using any sensor setting.
- 2 Be sure the exterior of the cooking container and the interior of the Microwave Drawer are dry. Wipe off any moisture with a dry cloth or paper towel.
- 3 The sensor works with foods at normal storage temperature. For example, popcorn would be at room temperature.
- 4 Any sensor selection can be programmed with More/Less Time Adjustment. See page 28.
- 5 More or less food than the quantity listed in the charts should be cooked following the guidelines in any microwave cookbook.
- 6 During the first part of sensor use "Sensing" will flash on the display. Do not open the Microwave Drawer or touch **Stop/Clear** during this part of the cycle. The measurement of vapor will be interrupted. If this occurs, an error message will appear. To continue cooking, touch the **Stop/Clear** pad and cook manually.
When the sensor detects the vapor emitted from the food, the remainder of cooking/reheating time will

appear. The Microwave Drawer may be opened when the remaining time appears on the display. At this time, you may stir or season food, as desired.

- 7 If the sensor does not detect vapor properly when cooking or reheating foods, error messages will be displayed, and the microwave will turn off.
- 8 Check food temperature after cooking. If additional time is needed, continue to cook manually.
- 9 Some foods have additional cooking tips in "Custom Help". Touch the **Custom Help** pad when it is showing in the display for additional cooking tips.

COVERING FOODS:

Some foods work best when covered. Use the cover recommended in the procedure for these foods. You may refer to the hints by touching the **Custom Help** pad.

- 1 Casserole lid.
- 2 Plastic wrap: Use plastic wrap recommended for microwave cooking. Cover dish loosely; allow approximately 1/2 inch to remain uncovered to allow steam to escape. Plastic wrap should not touch food.
- 3 Wax paper: Cover dish completely; fold excess wrap under dish to secure. If dish is wider than paper, overlap two pieces at least one inch to cover.

Be careful when removing any covering to allow steam to escape away from you.

REHEAT

You can reheat many foods without the need to calculate cooking times or power levels.

When you select **Reheat** from either the Home Screen or the Microwave Drawer Home Page, you will see six options. Most of these foods are reheated using the sensor. The foods that use the sensor are indicated with "*" in the chart on page 21. When reheating foods with the sensor, it is not necessary to enter quantity or weight. See the sensor cooking information above.

Some foods are best reheated without using the sensor. For reheating these foods, simply follow the directions on the touchscreen to enter quantity or weight. Either way, you'll get automatic cooking without the guesswork.

See next page for programming instructions.

MICROWAVE DRAWER COOKING

- Suppose you want to reheat 2 slices of pizza.

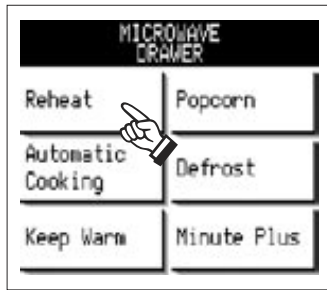

1 Touch **Reheat** pad.



2 Touch **Pizza** pad.



3 Touch number **2** pad. You can touch **Custom Help** for additional information or simply touch **START**. See page 27 for more information on **Custom Help**.

The display will begin counting down the reheating time.

REHEAT CHART

FOOD	AMOUNT
Refrigerated Foods*	4 - 36 oz.
Canned Foods*	4 - 36 oz.
Pizza	1 - 6 slices

FOOD	AMOUNT
Fresh Rolls or Muffins	1 - 8 pieces
Beverage Reheat	1/2 - 2 cups
Beverage Prepare	1 - 4 cups

* It is not necessary to enter quantity or weight.

POPCORN

You can pop popcorn with no need to calculate cooking time. Use only popcorn packaged for microwave oven use, one package at a time. The Popcorn pad will appear if you touch **Micro Cook** or **open the Microwave Drawer by touching OPEN**.

- Suppose you want to pop a regular size popcorn package.

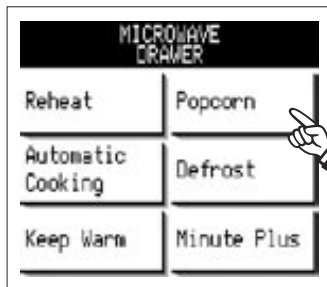

1 Touch **Popcorn** pad. You will need to touch **Micro Cook** or open the Microwave Drawer to access the **Popcorn** pad. You can also access the **Popcorn** pad by touching the **Microwave Drawer** pad.



2 Touch **Regular** pad. The microwave will start automatically.



3 When the sensor detects the vapor emitted from the food, the display will begin counting down the cooking time. Follow the instructions at the end.

POPCORN CHART

FOOD	AMOUNT
Regular / Regular light	2.85 - 3.5 oz.

FOOD	AMOUNT
Mini or Snack	1.2 - 1.75 oz.

MICROWAVE DRAWER COOKING

AUTOMATIC COOKING

Automatic Cooking has six categories and each category has several selections. Many sensor cooked foods are included. See the sensor cooking information on page 20. For foods not using the sensor, follow the directions on the touchscreen to enter quantity or weight. When cooking foods with the sensor, it is not necessary to enter quantity or weight. The foods using the sensor are indicated with “*” in the chart below and on page 23.

- Suppose you want to cook a baked potato.

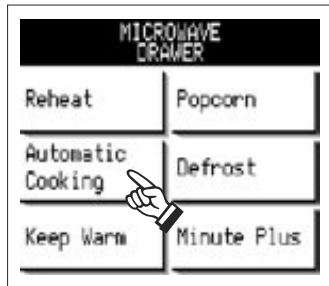

1 Touch **Automatic Cooking** pad. You will need to touch **Micro Cook** or open the Microwave Drawer to access the **Automatic Cooking** pad. You can also access the **Automatic Cooking** pad by touching the **Microwave Drawer** pad.



2 Touch **Fresh Vegetables** pad.

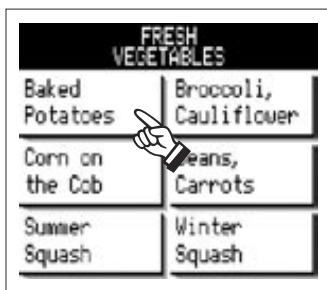

3 Touch **Baked Potatoes** pad.



4 Touch **START** pad. When the sensor detects the vapor emitted from the food, the display will begin counting down the cooking time.

AUTOMATIC COOKING CHART

FRESH VEGETABLES	AMOUNT
Baked Potatoes*	1 - 6 medium
Broccoli, Cauliflower*	0.25 - 2.0 lb
Corn on the cob*	0.25 - 1.5 lb
Beans, Carrots*	0.25 - 1.5 lb
Summer Squash, Winter Squash*	0.25 - 2.0 lb
MEATS, POULTRY, SEAFOOD	AMOUNT
Ground Beef*	0.25 - 2.0 lb
Boneless Pork Loin	2.0 - 3.5 lb
Meat Loaf	1.0 - 2.0 lb
Spareribs	1.0 - 2.0 lb

MEATS, POULTRY, SEAFOOD	AMOUNT
Whole Chicken	2.5 - 6.0 lb
Bone-in Chicken*	0.5 - 3.0 lb
Boneless Poultry*	0.5 - 1.5 lb
Ground Poultry*	0.25 - 1.5 lb
Fish Fillets*	0.25 - 2.0 lb
Fish Steaks*	0.25 - 2.0 lb
Shellfish*	0.25 - 2.0 lb
Fish Steaks	0.25 - 2.0 lb
Fish Kabobs*	0.25 - 1.0 lb

MICROWAVE DRAWER COOKING

AUTOMATIC COOKING CHART (CONT.)

FROZEN FOODS & SNACKS	AMOUNT
Vegetables*	0.25 - 1.25 lb
Entrees, Main Dishes*	6 - 40 oz
Snacks*	3 - 8 oz
Rolls or Muffins	1 - 8 pieces
Hot Dogs in Buns*	1 - 4
Soup*	1 - 6 cups
Chicken Nuggets*	0.25 - 1.0 lb
Soft Ice Cream	Pint, Quart, Half Gallon

* It is not necessary to enter quantity or weight.

Note:

- You can adjust doneness with More/Less Time Adjustment. See page 28.
- More or less than the quantity listed in the chart should be cooked following the guidelines in any microwave book.
- The final cooking result will vary according to the food condition (e.g. initial temperature, shape, quality, covering). Check food for temperature after cooking. If additional time is needed, continue to cook manually.

PASTA, GRAINS	AMOUNT
White Rice*	0.5 - 2.0 cups
Brown Rice*	0.5 - 2.0 cups
Fresh Pasta	8 - 9 oz
Dry Pasta	2 - 8 oz
BREAKFAST FOODS	AMOUNT
Scrambled Eggs	1 - 9 eggs
Bacon	2 - 6 slices
Hot Cereal	1 - 4 servings
Frozen Breakfast Foods*	1 (3 - 6 oz)

RECIPES FOR ONE DISH DINNERS (RECIPES SERVE 4)

Spicy Couscous

- 1 lb lean ground beef
 - 14¹/₂ oz can diced tomatoes
 - 1 c tomato sauce
 - 1 medium onion, chopped
 - 1/4 c chopped green pepper
 - 1/2 c couscous
 - 1 clove garlic, minced
 - 1 tbsp chili powder
 - 1 tsp ground cumin
 - 1 tsp dried oregano leaves
 - 3/4 c raisins
- Garnish: yogurt and chopped fresh parsley

Seafood Pasta

- 8 - 9 oz fresh tortellini
 - 1¹/₂ c water
 - 1¹/₂ c creamy Alfredo sauce
 - 1 lb raw shellfish like shrimp, scallops, crab
 - 2 c thinly sliced fresh vegetables like carrots, mushrooms, green beans
- Garnish: 1/4 c grated Parmesan cheese

Salsa Chicken

- 1¹/₄ oz dry taco seasoning
- 1 lb boneless chicken breast thin strips
- 6 oz pkg yellow rice mix with seasoning packet
- 2 c hot water
- 2 c frozen peas
- 1/2 c canned corn
- 1/2 c apricot preserves
- 14¹/₂ oz can diced tomatoes

Vegetarian Orzo

- 3/4 c orzo
 - 2¹/₂ c vegetable bouillon
 - 2 tbsp pesto sauce
 - 1/3 c small pieces of sundried tomatoes
 - 2 tsp minced garlic
 - 2 tsp Italian seasoning
 - 2 c chopped green, red, orange & yellow peppers
 - 1 medium onion, thinly sliced
 - 14 oz can artichoke hearts, drain & quarter
 - 3 oz pitted ripe olives, cut in half
- Garnish:
- 1/3 c Parmesan cheese, freshly grated
 - 2 tbsp pinenuts

MICROWAVE DRAWER COOKING

RECIPES FOR LOW CALORIE ENTREES (RECIPES SERVE 4)

Steak Fajitas

- 3/4 lb beef flank steak, cut in diagonal inch strips
- 1/3 c orange juice
- 2 tbsp lime juice
- 1 tbsp minced garlic
- 1 tbsp Worcestershire sauce
- 1 tbsp chili powder
- 1/2 tsp cumin
- 1 1/2 c red, green and yellow pepper strips
- 1 medium onion, chopped
- 1 c black beans, rinsed and drained
- 4 10-inch warm flour tortillas
- 1 medium tomato, chopped
- 1/3 c salsa
- 1/2 c fat free sour cream

Glazed Pork Tenderloin

- 1 lb whole pork tenderloin
 - 1 tsp rosemary, salt and pepper
 - 1 lb sweet potatoes, 2-inch cubes
 - 1 orange, thinly sliced
- Glaze:
- 4 oz whole cranberry sauce
 - 1/4 c red wine
 - 1 tbsp steak sauce
 - 2 tbsp flour

Thai Chicken Kabobs

- 2 tbsp lime juice
- 1 tsp cooking oil
- 1 tsp soy sauce
- 1/8 tsp red pepper
- 1 lb boneless chicken, cut in 1-inch cubes
- 4 small onions, quartered
- 2 medium red peppers, cut into 1-inch pieces
- 2 tsp light peanut butter

Ratatouille

- 1/4 c olive oil
- 1 medium eggplant, peeled and cut in 1-inch cubes
- 1 medium onion, sliced thinly
- 4 small new potatoes, cut in 3/4-inch cubes
- 1 clove garlic, minced
- 1 medium zucchini, sliced thinly
- 1 green pepper, cut into thin strips
- 2 c sliced fresh mushrooms
- 14 1/2 oz can seasoned, diced tomatoes
- 1 1/2 tsp dried basil leaves
- 1 1/2 tsp marjoram leaves
- salt and pepper to taste

RECIPES FOR SUPPER SOUPS & SAUCES (RECIPES SERVE 4)

Chicken Noodle

- 1 tsp oil
- 1 onion, sliced thinly
- 1/2 c thin sliced celery
- 1 1/2 c thin sliced carrots
- 4 c chicken broth
- 1 lb bone-in chicken pieces
- 3/4 c fine egg noodles
- 1/3 c chopped parsley
- salt and pepper

Split Pea Soup

- 3 c water
- 2 c vegetable bouillon
- 1/2 c dried split peas
- 1/3 c chopped onion
- 1 clove garlic, minced
- 1/4 tsp dried marjoram
- 1/4 tsp dried thyme leaves
- 1 bay leaf
- 1/8 tsp cayenne pepper
- 3/4 c sliced carrots
- 3/4 c diced potatoes
- 1/3 c sliced celery

MICROWAVE DRAWER COOKING

RECIPES FOR SUPPER SOUPS & SAUCES (RECIPES SERVE 4) CONT.

Meat Sauce

- 3/4 lb ground beef
- 1/3 lb sweet Italian sausage
- 8 oz chopped, canned mushrooms, drained
- 1 small onion, minced
- 2 cloves garlic, minced
- 1 stalk celery, minced
- 1 carrot, minced
- 1/3 c red wine
- 1/3 c water
- 28 oz can tomato puree
- 6 oz can tomato paste
- 1 tsp sugar
- 1 tsp dried basil
- 1 tsp oregano
- 1/4 tsp crushed red pepper
- 1 tsp salt
- 1/4 tsp pepper

Vegetarian Chili

- 3/4 c sliced carrots
- 3/4 c sliced celery
- 1/2 c chopped red pepper
- 1/2 c chopped green pepper
- 1/2 c sliced green beans
- 1 medium onion, minced
- 1 cloves garlic, minced
- 28 oz can crushed tomatoes
- 15 oz can kidney beans, rinsed and drained
- 15 oz can black beans, rinsed and drained
- 1 1/2 c water
- 1/3 c barley
- 1 tbsp chili powder
- 1/2 tsp cumin
- 2 tsp Italian seasoning
- 1/4 tsp pepper
- 1 tsp salt

Garnish: Parmesan cheese or sour cream

RECIPES FOR DELICIOUS DESSERTS (RECIPES SERVE 4)

Almond Bread Pudding

- 2 c half and half
- 2 tbsp unsalted butter, melted
- 2 large eggs, beaten
- 3/4 c sugar
- 1 tsp almond extract
- 1/2 c golden raisins
- 1/2 c slivered, blanched almonds, toasted
- 6 c 2-inch cubed French or Challah bread

Sauce:

- 1/4 c unsalted butter, melted
- 1/2 c sifted confectioners' sugar
- 1 large egg
- 2 tbsp bourbon

Cherry Pie Pudding

- 21 oz cherry pie filling
- 4 c sponge or angel food cake cubes
- 2 c milk
- 4 eggs
- 1 tsp sugar
- 1/2 tsp almond extract
- 1 16 oz can drained, Bing cherries

Caribbean Cake

- 2 tbsp butter, melted
- 1/4 c brown sugar
- 1/4 c apricot preserves
- 8 oz can crushed pineapple drained well
- 2 tbsp sliced, blanched almonds
- 1/3 c dried, sweetened cranberries (Craisins)
- 1 9 oz pkg yellow cake mix or 1/2 box regular size
- 1 egg
- 2 tbsp rum
- 6 tbsp pineapple juice and/or water

Turtle Bars

- 1 1/2 c quick oatmeal
- 1/2 c light brown sugar
- 1/2 c all-purpose flour
- 1/2 c melted butter
- 20 caramel candies
- 1 tsp milk
- 1/2 c milk chocolate chips
- 1/2 c pecan pieces

MICROWAVE DRAWER COOKING

DEFROST

Defrost pad automatically defrosts all the foods found in the Defrost chart below.

- Suppose you want to defrost 1.2 lb ground meat.

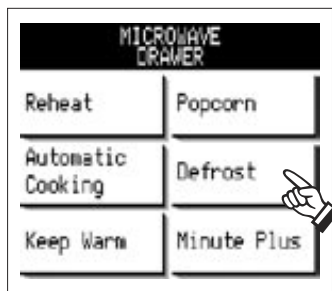

1 Touch **Defrost** pad.

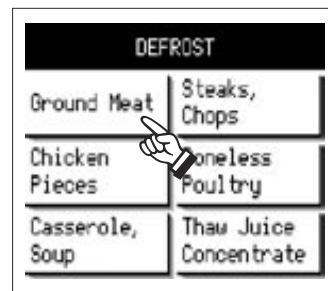

2 Touch **Ground Meat** pad.



3 Enter weight by touching number pads **1****2**. Then touch **START**.



4 The display will begin counting down the defrosting time. Follow instructions at the end.

DEFROST CHART

FOOD	AMOUNT
Ground Meat	0.5 - 2.0 lb
Steaks, Chops	0.5 - 3.0 lb
Chicken Pieces	0.5 - 3.0 lb

FOOD	AMOUNT
Boneless Poultry	0.5 - 2.0 lb
Casserole, Soup	1 - 6 cups
Juice Concentrate	6 oz, 12 oz, 16 oz

Note:

- You can input the amount only within the range of the Defrost Chart.
- Defrost can be programmed with More/Less Time Adjustment. See page 28.
- To defrost other foods or foods above or below the weights allowed on Defrost Chart, see Manual Defrost below.
- If the **Custom Help** pad appears, you can get additional information by touching it. To return to the previous page, touch the **^** pad, then touch **START**.

MANUAL DEFROST

If the food that you wish to defrost is not listed on the Defrost Chart or is above or below the limits in the AMOUNT column on the Defrost Chart, you need to defrost manually.

You can defrost any frozen food, either raw or previously cooked, by using 30% power. Estimate defrosting time, enter it and follow the exact procedure found on Variable Power Cooking on page 18.

For either raw or previously cooked frozen food the rule of thumb is approximately four minutes per pound. For example, defrost four minutes for one pound of frozen spaghetti sauce.

Always stop the oven periodically to remove or separate the portions that are defrosted. If food is not defrosted at the end of the estimated defrosting time, program the oven in one minute increments on 30% power until totally defrosted.

When using plastic containers from the freezer, defrost only long enough to remove from the plastic in order to place in a microwave-safe dish.

OTHER CONVENIENT FEATURES

KEEP WARM

Keep Warm allows you to keep food warm up to 30 minutes. The **Keep Warm** pad will appear if you touch the **Micro Cook** or **Microwave Drawer** pad or open the Microwave Drawer by touching **OPEN**.

- Suppose you want to keep food warm for 20 minutes.

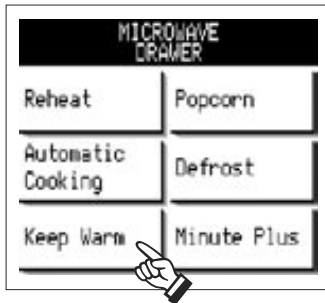

1 Touch **Keep Warm** pad.



2 Enter time by touching number pads **2000**. Then touch **START**.



3 The display will begin counting down the keep warm time.

Note: If you attempt to enter more than 30 minutes for Keep Warm, an error message will appear in the display.

MINUTE PLUS™

Minute Plus allows you to cook for a minute at 100% by simply touching the **Minute Plus** pad. You can also extend cooking time in multiples of 1 minute by repeatedly touching the **Minute Plus** pad during manual cooking.

There are several ways to access the **Minute Plus** pad.

1 **Minute Plus** appears on the control panel, combined with the **START** pad for the Microwave Drawer.

2 The **Minute Plus** pad will appear in the touchscreen if you touch **Micro Cook**, the **Microwave Drawer** pad or open the Microwave Drawer by touching **OPEN**. If you touch the **Minute Plus** pad on the touchscreen, microwave cooking will start immediately. You can add time in one minute increments by touching this pad during cooking.

3 When you have set microwave cooking time manually, the **Minute Plus** pad will appear on the touchscreen. You can add time in one minute increments by touching this pad.

Note:

- To use Minute Plus, touch **Minute Plus** pad within 3 minutes after cooking, closing the Microwave Drawer or touching the **Stop/Clear** pad.
- Minute Plus cannot be used with any of the automatic settings nor with Keep Warm.

CUSTOM HELP®

When you are using the automatic cooking features, sometimes you will see the **Custom Help** pad appear. By touching it, you will see additional cooking tips and information. Often this information is already displayed on the touchscreen, but occasionally because of space, the **Custom Help** pad is using to get to another screen for additional help. Once you have read the information in Custom Help, use the  pad on the control panel to return to the previous screen.

MICROWAVE DRAWER COOKING

MORE/LESS TIME ADJUSTMENT

The programmed cooking times are tailored to the most popular tastes. To adjust the cooking time to your individual preference, use the **More/Less** pad to either add or reduce cooking time.

- Suppose you want to reheat a refrigerated food for more time.

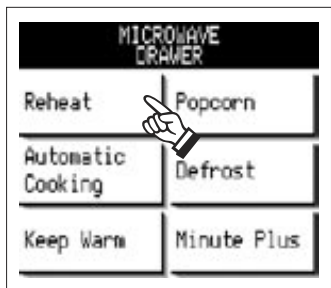

1 Touch **Reheat** pad.



2 Touch **Refrigerated Foods** pad.



3 Then touch **START**.



4 After touching the **START** pad, **More/Less** will appear. Touch once for more time.

Note:

- For less time, touch **More/Less** pad again. The word "MORE" or "LESS" will appear in the lower left-hand corner of the display to confirm your selection.
- Choosing More/Less time must be done within seven seconds after touching **START**.

For information on setting the Microwave Drawer for **Delay Start**, to turn the audible signal on or off (**Sound Adjustment**) or to turn off the **Continuous Reminder**, see **SETUP** on page 40.

INFORMATION YOU NEED TO KNOW

- Be sure all packing material is removed from oven before turning on.
- **Oven vent location** - The oven vent is located at the right side of the front panel between the Microwave Drawer and oven. This area could become hot during oven use. It is normal for steam to come out of the vent. The vent is important for proper air circulation in the oven and good baking results. Never block this vent.

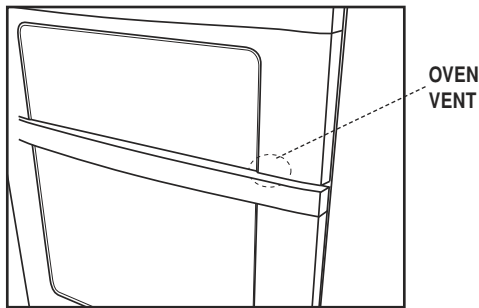

- Do not use oven for storing food or cookware.

BEFORE USING OVEN

REMOVING AND REPLACING OVEN RACKS

The standard rack has stops so that when placed correctly on the supports it will stop before coming completely out and will not tilt.

To remove, pull the rack forward until it stops. Lift front of rack up and slide out.

To replace, fit the rack onto the guides on the oven walls. Tilt the front of the rack upward and slide the rack back into place.

Directions for removing and replacing the EZ Pull racks are on page 10. Read instructions and use racks correctly.

AIR CIRCULATION IN THE OVEN

Baking results will be better if baking pans are centered in the oven as much as possible. If baking four cake layers at the same time, place two layers on rack #1 and two layers on rack #3. Stagger pans on the rack so one is not directly above the other. For best air circulation and baking results allow 2-4 inches around the cookware and be sure pans and cookware do not touch each other, the oven door, sides or back of the oven cavity. The hot air must circulate around the pans and cookware in the oven for even heat to reach around the food.

ALUMINUM FOIL

Do not place aluminum foil on the oven bottom. It is not recommended to use aluminum foil to line the broiler pan and broiler grid. If you would like to use it to make cleaning easier, you must mold the foil tightly to the grid and cut slits in it just like the grid. Without the slits, the foil will prevent fat and meat juices from draining into the broiler pan, and then the juices could become hot enough to catch on fire.

OVEN BAKING AND BROILING

The Bake and Broil features use the top and bottom heaters; however, no air is moving. This heater usage is the traditional way electric ovens bake and broil. Standard cooking directions and most cookbooks use traditional times and temperatures so can be used when using Bake and Broil.

RECOMMENDED RACK POSITIONS FOR BAKE AND BROIL

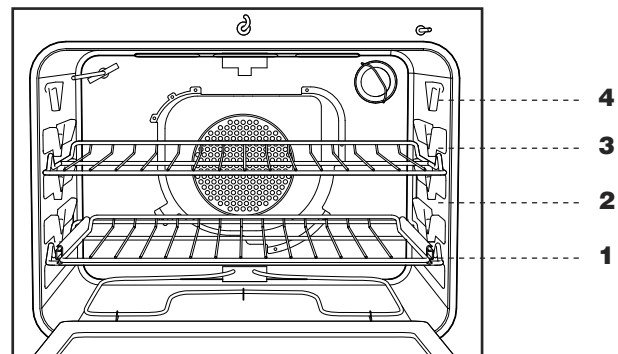

FOOD	RACK POSITION
Toasting bread	4
Broiling meats, chicken or fish	2 or 3
Baking cookies, cakes, pies, biscuits or muffins	2 or 3
Baking frozen pies, angel food cake, yeast bread or casseroles	1
Roasting poultry	1
Roasting meats	1
Baking on 2 racks at the same time	1 & 3

Note: Follow package instructions and recipe times. The cooking times and temperatures needed to bake a product may vary slightly from your previously owned appliance.

OVEN COOKING

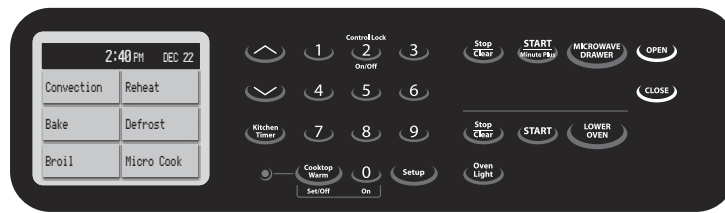

HOW TO SET OVEN TEMPERATURE FOR BAKE

SET TEMP

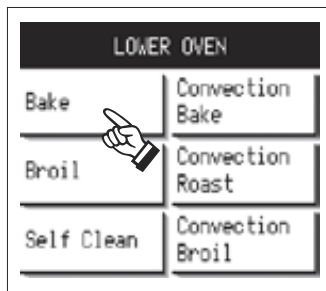

1 Touch **Bake** pad.

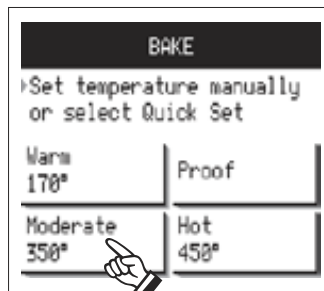

2 Touch number pads or pre-set pads for desired temperature.



3 Touch **START** pad. When the oven reaches the programmed temperature, a signal will sound.

TO CHANGE SET TEMPERATURE DURING PREHEATING OR AFTER OVEN IS PREHEATED:

1 Follow the steps 1-3 above.

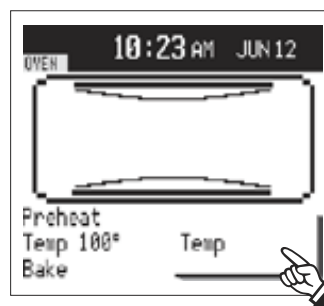

4 During preheating, the Temp pad will appear in the lower right-hand corner of the touchscreen. Touch this pad to do the following:

- Temp x 1: Check the set temperature.
- Temp x 2: Change the set temperature. When you see 000° in the lower left-hand corner of the touchscreen, use the number pads to change the temperature, then touch **START**.
- Temp x 3: Display shows the actual temperature during preheating. It will read “Temp Lo F” until the oven reaches 90°F.

Once the oven is preheated, the Temp pad will remain in the display. By touching it once, you can change the set temperature using the number pads. Then touch **START**. If you touch it a second time, it will once again show the set temperature.

HOW TO PROOF

The Insight Range has an automatic setting for proofing bread dough at 100°F. You can access the “Proof” pad by touching the **Bake** pad. The oven temperature can also be set manually for 90-100°F for proofing bread dough. If you have just finished using the oven and the residual temperature is 105°F or higher, when you enter 90-100°F or select **Proof** and touch the **START** pad, the oven will display “OVEN TOO HOT”. The oven will not start until it cools below 105°F, a safe temperature for yeast. When the oven cools, the oven display will change to “Touch START”. Simply touch the **START** pad and the oven will maintain 90-100°F for proofing.

HOW TO SET TIMED COOK

The oven will turn on immediately and cook for a selected length of time. At the end of the cooking time the oven will turn off automatically.

BAKE USING TIMED COOK

- Suppose you want to bake for 1 hr. 45 min.

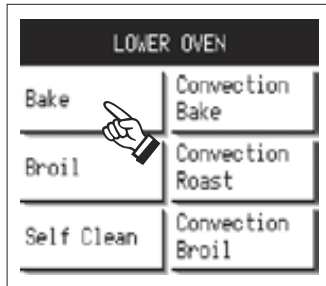

1 Touch **Bake** pad.

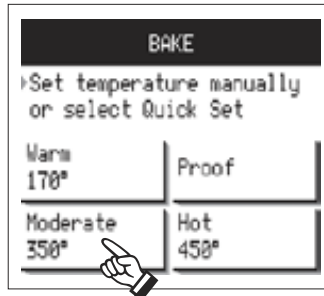

2 Touch number pads or pre-set pads for desired temperature.

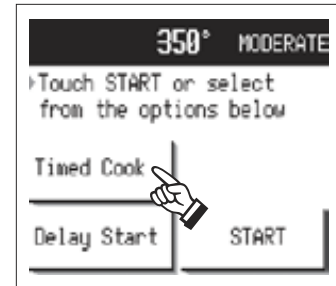

3 Touch **Timed Cook** pad.



4 Touch number pads **1****4****5** to enter cooking time in hours and minutes. Touch **START**.

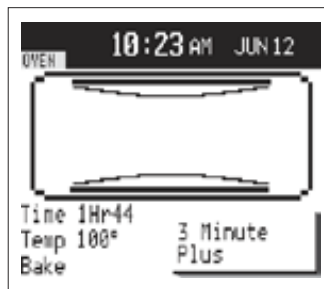

5 Cooking time begins counting down. When the oven preheats to the programmed temperature, a signal will sound. When cooking time is completed, a signal will sound and oven will turn off.

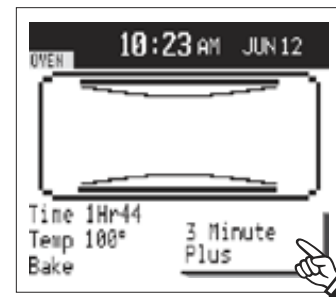

6 Touch the **3 Minute Plus** pad to add 3 minutes to the set cooking time. Each time you touch the **3 Minute Plus** pad, the countdown time will be extended by 3 minutes. The 3 Minute Plus option will only appear when you have selected **Timed Cook**.

Note: The oven will cook for the set amount of time, then turn off automatically. The oven will remain hot even though the oven has turned off, so remove food promptly to avoid overcooking.

OVEN COOKING

HOW TO SET DELAY START

The oven will turn on at the time of day you set.

Make sure the clock on the display shows the correct time of day. To set correct time, see page 13.

Foods that spoil easily such as dairy products, pork, poultry or seafood are not recommended for delay start cooking.

BAKE

- Suppose you want the oven to begin cooking at 4:30 PM.



1 Touch **Bake** pad.

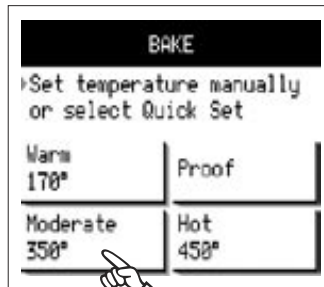

2 Touch number pads or pre-set pads for desired temperature.



3 Touch **Delay Start** pad.



4 Touch number pads **4|3|0** to set the time of day for the oven to begin cooking. Touch **START** or select **Timed Cook**.



5 If you touch the **START** pad, the oven will come on at 4:30 PM. If you select **Timed Cook** (following the directions on page 31) the oven will come on automatically at 4:30 PM, then turn off automatically at the end of the set cooking time.

Note:

- The oven will cook for the set amount of time, then turn off automatically if you set Timed Cook.
- If you do not select Timed Cook, the oven will not turn off automatically. You must touch **Stop/Clear** to turn off the oven.
- If your recipe requires preheating, you may need to add additional cooking time.
- Baked items that require a preheated oven, such as cakes, cookies and breads, are not recommended to be cooked with the delay start feature.

HOW TO SET BROIL

Leave the door open to the broil stop position. Place the food on the broiler grid in the broiler pan.

Follow suggested rack positions in the Broiling Chart on page 34. Preheating is suggested for rare steaks. To preheat, touch **Broil** and wait 2 to 3 minutes before putting broiler pan with food into the oven.

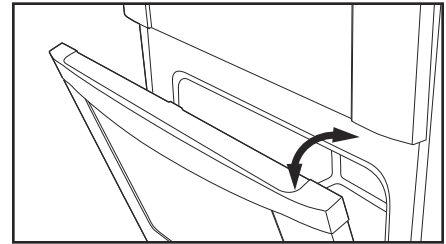

TO BROIL



1 Touch **Broil** pad.

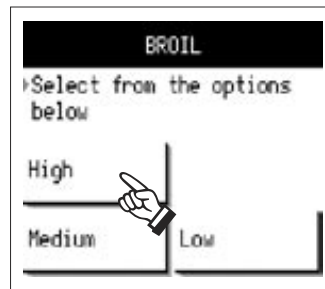

2 Select the desired setting.



3 Touch **START**.

Use the table on page 34 for approximate broiling times. Increase or decrease broiling times or move the broiling pan to a different rack position to achieve desired doneness.

High broil is used for most broiling. Use Medium or Low broil to cook foods such as thick cuts of meat thoroughly without excessive browning.

Broil will automatically turn off after 5 hours if it is accidentally left on. This feature can be cancelled. See 12 Hour Shut Down on page 41.

TO CHANGE BROIL SETTING DURING USE:

You can change the Broil setting by touching the **Temp** pad that appears on the touchscreen. Keep touching the **Temp** pad until you see the setting you want in the lower left-hand corner of the touchscreen.

- Suppose you want to change broil from High to Medium.

1 Follow To Broil steps 1-3 above. In step 2, select **High**.

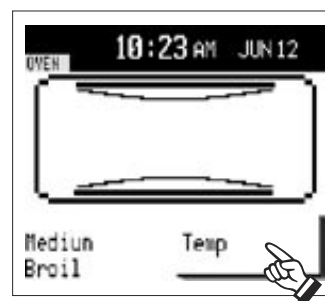

4 Touch **Temp** pad. The lower left display will show Medium Broil.

OVEN COOKING

BROILING CHART

FOOD	AMOUNT	DONENESS	BROIL SETTING	SHELF POSITION FROM BOTTOM	FIRST SIDE TIME (MIN.)	SECOND SIDE TIME (MIN.)
BEEF						
Hamburgers	1/4 lb. each (1" thick)	Medium	High	3	7 - 10	6 - 8
		Well Done	High	2 or 3	9 - 11	7 - 9
Rib-eye steak	3/4 - 1" thick (7 - 8 oz. each)	Rare	High	3	5 - 7	3 - 5
		Medium	High	3	6 - 8	4 - 6
		Well Done	High	3	8 - 9	9 - 11
Steaks: Sirloin, Porterhouse, T-bone	1 - 1 1/2"	Rare	High	3	5 - 7	3 - 5
		Medium	High	3	6 - 8	8 - 10
		Well Done	Medium	3	8 - 10	11 - 13
Chuck Steak	1"	Rare	High	3	5 - 7	6 - 8
		Medium	High	3	7 - 9	8 - 10
		Well Done	High	3	9 - 11	11 - 13
London Broil	1 - 1 1/4" 2 1/2 - 3 lb.	Rare	High	2	11 - 13	12 - 14
		Medium	High	2	12 - 14	14 - 16
PORK						
Chops: loin or center	3/4 - 1"	Well Done	High	3	7 - 9	9 - 11
LAMB						
Chops: rib, loin or center	3/4" 3 - 4 oz. each	Medium	High	3	5 - 7	6 - 8
		Well Done	High	3	7 - 9	8 - 10
CHICKEN						
Broiler-Fryer, halved, quarter	1 - 3 lb.	Well Done	High	2	12 - 14	17 - 19
FISH						
Fillet	1/4 - 3/4"	Well Done	High	3	10 - 12	No turnover
Steaks	3/4"	Well Done	High	3	12 - 14	No turnover
TOAST - No preheat			High	4	2 - 3	

Note: The broiling times will be longer and browning will be lighter if appliance is connected to 208 volts.

CONVECTION COOKING

The Convection settings use heaters on the top and bottom of the oven as well as a rear heater located behind the rear wall and convection fan cover. The rear heater is used for true European convection performance. There are various sequences of the heaters used to achieve ideal cooking. The convection fan moves the heated air throughout the entire oven to ensure even browning and crisping.

The rear heater shuts off if the oven door is open for longer than one minute. The convection fan shuts off when the door is opened. Keep heat loss to a minimum by only opening the oven door when necessary and always closing it quickly.

HOW TO SET OVEN TEMPERATURE FOR CONVECTION BAKE

CUSTOM CONVERSION

One of the features you'll enjoy most on the Insight Range is Custom Conversion for Convection Baking. By following the options and directions that appear on the touchscreen, Custom Conversion technology automatically converts your cooking temperature and time for optimal results.

- Suppose your layer cake recipe says to bake at 400°F for 30 minutes. The Insight Range will automatically convert this temperature and time for convection cooking.

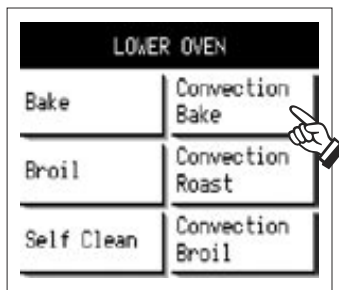

1 Touch **Convection** pad or **Lower Oven** pad. Then touch **Convection Bake** pad.



2 Touch **Cakes** pad.

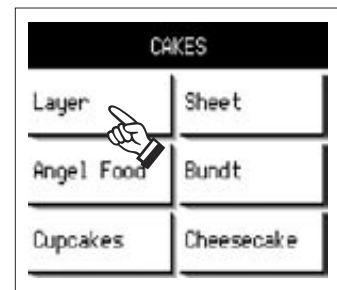

3 Touch **Layer** pad.

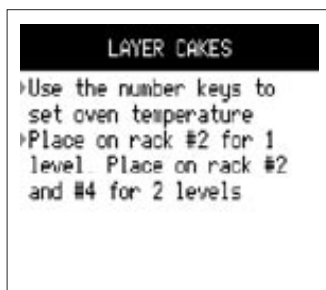

4 To set temperature, touch number pads **4 0 0**, then touch **ENTER**.



5 To set time, touch number pads **3 0** and touch **ENTER**.



6 Touch **START**. Temperature and/or time will be adjusted automatically. Notice that the converted temperature is now shown in the banner.

When the oven preheats to the programmed temperature, a signal will sound. Place food in the oven after the signal and close the oven door. At this point, the cooking time (Kitchen Timer) will begin counting down in the banner. When the timer reaches zero, a signal will sound. See notes below.

Note:

- When setting the cooking time, use the minimum baking time given in your recipe or on the package. Time is entered in hours and minutes.
- When you set the time, you are actually setting the Kitchen Timer. The word "Kitchen Timer" will appear in the banner, along with the countdown time. When the timer reaches zero, "CHECK FOR DONENESS" will appear in the display and a signal will sound 7 short beeps. This signal will continue to sound periodically until you either open the oven door or turn on the oven light to check the food.

OVEN COOKING-CONVECTION

- Since recipes vary, the food may need additional cooking time. Simply return the food to the oven and watch it closely until done or you can set the Kitchen Timer. You do not need to reset the oven temperature.
- The oven will not turn off until you touch the oven's **Stop/Clear** pad.

TO CHANGE SET TEMPERATURE DURING PREHEATING OR AFTER OVEN IS PREHEATED:

- 1 Follow the How To Set Oven Temperature For Convection Bake steps 1-6 on page 35.



- 7 Touch **Temp** pad. The lower left display will show 000°. Touch the number pads for desired temperature.

See page 30, "To Change Set Temperature during Preheating or after oven is preheated" for more complete information.

MANUAL TIMING

To set Convection Bake temperature and cooking time manually, select the **Manual Timing** pad under Convection Bake and follow the instructions.

CONVECTION ROAST

Use the broiler pan, grid and roast/broil rack. The roast/broil rack enables the heated air to circulate on all sides of the roast or poultry so that juices are sealed in and the outside browns well.

Foods are placed in the oven directly from the refrigerator. There is no need to preheat. Always use a meat thermometer to ensure the correct removal temperature.

HOW TO SET CONVECTION ROAST

- Suppose you want to roast a chicken at 300°F for 40 min. The Insight Range will use Custom Conversion to automatically convert this temperature and time for Convection Roast of meats and poultry.

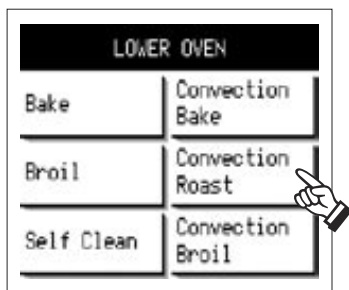

- 1 Touch **Convection** pad or **Lower Oven** pad. Then touch **Convection Roast**.

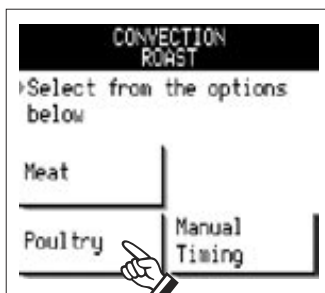

- 2 Touch **Poultry** pad.



- 3 To set temperature, touch number pads **3|0|0**, then touch **ENTER**.

OVEN COOKING-CONVECTION



4 To set time, touch number pads **4|0** and touch **ENTER**.



5 Temperature and/or time will be adjusted automatically. Now touch **START** or select **Delay Start**.

HOW TO SET DELAY START

The oven will turn on at the time of day you set. **Make sure the clock shows the correct time of day. To set correct time, see page 13.**

Foods that spoil easily such as dairy products, pork, poultry or seafood are not recommended for delay start cooking.

- Suppose you want the oven to start later at 4:30 PM.

1 Follow the How To Set Convection Roast steps 1-4.

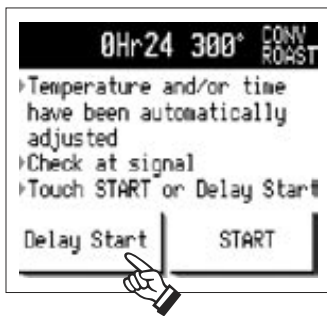

5 Touch **Delay Start** pad.



6 To set time of day for the oven to begin cooking, touch number pads **4|3|0**. Then touch **START** or select **Timed Cook Start**. If you do not select **Timed Cook**, the oven will not turn off automatically. You must touch **Stop/Clear** to turn off the oven.

Note:

- The oven will cook for the set amount of time, then turn off automatically if you set Timed Cook.
- If your recipe requires preheating, you may need to add additional cooking time.

MANUAL TIMING

To set Convection Roast temperature and cooking time manually, select the **Manual Timing** pad under Convection Roast and follow the instructions.

OVEN COOKING-CONVECTION

CONVECTION BROIL

Use the broiler pan, grid and roast/broil rack. The roast/broil rack enables the heated air to circulate on all sides of the foods ensuring no need to turnover during broiling. The juices are sealed in and all sides brown well.

Allow the oven to preheat when using Convection Broil. Place 1/4 to 1/2 cup of water in the bottom of the broiler pan to help eliminate any smoking and make clean-up easy.

The door is **closed** during Convection Broil.

See the Convection Broiling Chart below for suggested foods and times.

HOW TO SET CONVECTION BROIL

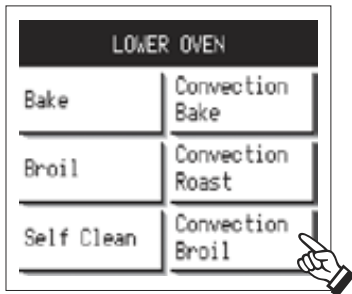

1 Touch **Convection** pad or **Lower Oven** pad. Then touch **Convection Broil**.



2 Touch **START**. When the oven is preheated, a signal will sound.

CONVECTION BROILING CHART

FOOD	RACK POSITION	BROILING TIME AFTER PREHEAT
Bacon	3	3 - 5 min.
Chicken, broiler halves, quarters or pieces	1	14 - 20 min.
Chicken, breast boneless	3	9 - 12 min.
Frankfurters	3	5 - 7 min.
Hamburgers	1	8 - 10 min.
Ham slice, fully cooked	3	10 - 12 min.
Sausage	1	8 - 10 min.
Toast	3	1 1/4 min., turnover 1 min. more

Note: The broiling times may be longer and browning may be lighter if appliance is connected to 208 volts.

HOW TO START SELF-CLEAN

Remember to allow time for the oven to cool down and the oven door to unlock (approx. 1 hour) if you are planning to use the oven after a self-clean cycle. Remove the broiler pan and broiler grid, all utensils and any foil. We recommend removing the oven racks. If they go through the clean cycle, they will darken, lose their luster and become hard to slide. With soap and water, clean any soil from the oven frame and the area outside the gasket on the door. These areas heat during self-cleaning cycle so soil could be burned on. To avoid heavy smoke or fire when subjected to high temperature, remove heavy spillovers in the oven using hot soapy water and cloth before cleaning cycle.

We recommend venting your kitchen with an open window or using a ventilation fan during the self-cleaning cycle.

- Suppose you want to set the oven for the Light Self-Cleaning cycle.

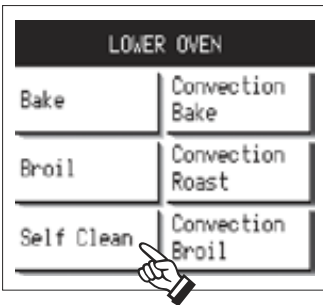

1 Touch the **Lower Oven** pad on the control panel. Then touch **Self Clean** pad.



2 Touch **Light** pad.

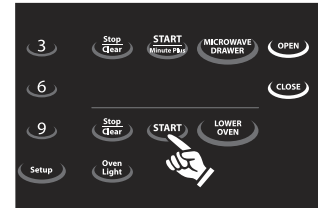

3 Touch the Lower Oven **START** pad on the control panel.

HOW TO SET SELF-CLEAN DELAY START

- Suppose you want the oven to start later at 10:00 PM.

1 Follow the How To Start Self-Clean steps 1-2.



3 Touch **Delay Start** pad.



4 To set time of day for the cleaning cycle to begin, touch number pads **1000** and touch **START** pad.

Oven locks automatically. For immediate start, cleaning time appears and begins counting down. If you have selected Delay Start, the oven will not turn on and the timer will not begin counting down until the time of day you have set. When self cleaning time is completed, a signal will sound. It will not be possible to open the door until the temperature drops below the lock temperature and “COOL” indicator goes off.

After a self-clean cycle, you may notice some white ash in the oven. Wipe it up with a damp cloth after the oven cools. Gently lift the bottom element to wipe underneath it. It cannot be removed.

If the racks become hard to slide, apply a small amount of cooking oil to a paper towel and wipe the edges of the oven racks.

Note: The health of some birds is extremely sensitive to the fumes given off during the self-cleaning cycle of any range. Move birds to another well-ventilated room.

During the self-cleaning cycle, the outside of the oven can become very hot to touch. Do not leave small children unattended near the appliance.

If heavy spillovers are not wiped up before the self-cleaning cycle, they may flame and cause more smoke and odor than usual. This is normal and safe and should not cause alarm.

The glass ceramic cooktop and the Microwave Drawer can be used while the oven is self-cleaning.

OTHER FEATURES

OVEN LIGHT

The oven light automatically comes on when the door is opened. When the door is closed, Touch **Oven Light** pad on the control panel to turn the light on or off.

The oven light will come on automatically one minute before the end of a time-controlled oven cooking operation (Timed Cook).

KITCHEN TIMER

- Suppose you want to set Kitchen Timer for 15 minutes.



1 Touch **Kitchen Timer** pad on the control panel.



2 Touch **Min/Sec** pad*.



3 To set time, touch number pads **1****5****0****0** and touch **Kitchen Timer** pad.

TO CANCEL, TOUCH AND HOLD KITCHEN TIMER PAD FOR 3 SECONDS.

* If you want to set the Kitchen Timer in hours and minutes, touch **Hr/Min** pad. Example: To set 1 hour 15 minutes, touch **1****1****5**. Check the Kitchen Timer in the banner to make sure you have set the timer as you desired. When the countdown timer reaches 59 minutes, 59 seconds, it will count down in minutes and seconds.

CONTROL LOCK

The Control Lock prevents unwanted oven, drawer and Cooktop Warm operation, such as by small children. It can be set so that the control panel is deactivated or locked. All range functions must be off with Home Screen showing and the Microwave Drawer closed before setting.

TO LOCK

Touch **Control Lock** **2** pad and hold for 3 seconds. The display shows "CONTROL PANEL LOCKED". When you first touch and hold **2**, microwave cooking screen will appear. Continue to hold until "CONTROL PANEL LOCKED" appears.

TO UNLOCK

Touch **Control Lock** **2** pad and hold for 3 seconds. The display shows "CONTROL PANEL UNLOCKED".

Note: Control Lock can be used only when neither lower oven nor microwave drawer is in operation, cook top warm and oven light are OFF and drawer door is closed.

SETUP

The Setup has ten functions.

1. Clock
2. Delay Start
3. Sound Adjustment
4. Continuous Reminder
5. Lock Lower Oven

6. 12 Hour Shut Down
7. Video Demo
8. Demo Mode
9. Adjust Oven Temperature
10. Screen Contrast

CLOCK

Touch **Setup**, touch **Clock**, and then follow the directions on the screen. See page 13.

DELAY START

The Delay Start function allows you to set your Microwave Drawer or lower oven to start automatically at a later time. Touch **Setup**, touch **Delay Start** to program the Microwave Drawer or oven to begin cooking automatically at a designated time. Follow the directions on the screen.

SOUND ADJUSTMENT

The oven offers a choice of Sound On or No Sound. Touch **Setup**, touch **Sound Adjustment**, and then follow the directions on the screen.

CONTINUOUS REMINDER

At end of cooking, Microwave Drawer or oven will signal every 10 seconds for the first minute, then every 3 minutes for 1 hour until the drawer or oven door is opened or **Stop/Clear** pad is touched. This function can be canceled. Press **Setup**, touch **Continuous Reminder**, and then follow the directions on the screen.

LOCK LOWER OVEN

The lower oven can be locked to prevent unauthorized use.

To lock oven door, touch **Setup**, touch **Lock Lower Oven**, and then touch **Lock Lower Oven**.

To unlock oven door, touch **Setup**, touch **Lock Lower Oven**, and then touch **Unlock Lower Oven**.

12 HOUR SHUT DOWN

The lower oven will automatically turn off after 12 hours of baking or roasting operation, and after 5 hours of broiling operation if it is accidentally left on. This feature can be deactivated, if desired.

To deactivate 12 Hour Shut Down, touch **Setup**, touch **12 Hour Shut Down**, and then touch **Shut Down OFF**.

To re-activate 12 Hour Shut Down, touch **Setup**, touch **12 Hour Shut Down**, and then touch **Shut Down ON**.

VIDEO DEMO

The Video Demo is an automated “tour” through many of the features of this range. To see a video demo, press **Setup**, touch , touch **Video Demo**, and then touch **Video Demo ON**.

DEMO MODE

The Demo Mode is a learning tool. Using this function, neither the Microwave Drawer nor the oven will heat. The count down timer moves very quickly.

To use Demo Mode, touch **Setup**, touch , touch **Demo Mode**, and then touch **Demo Mode ON**.

Whenever the **Demo Mode** is turned on, the word “DEMO” will flash in the upper left-hand corner of the banner. If the Demo Mode is on and the range is not used for one minute, the Video Demo will play. To turn it off, follow the directions in the display or touch **Stop/Clear**.

To cancel Demo Mode, touch **Setup**, touch , touch **Demo Mode**, and then touch **Demo Mode OFF**.

ADJUST OVEN TEMPERATURE

Your new oven may cook differently than your previous oven. For the first few weeks, use suggested package times and temperatures. Should you determine that an adjustment is desirable, try a few recipes or prepared foods to determine the number of degrees for the actual oven adjustment. The oven temperature can be increased (+) or decreased (-) up to 35°F.

TO RAISE OR LOWER OVEN TEMPERATURE

• Suppose you want to lower the temperature for 20°.

1 Touch **Setup**, touch , touch **Adjust Oven Temperature**.



2 Keep touching the **Lower** pad until -20° is shown.

3 Touch **ENTER** pad.

SCREEN CONTRAST

Normally there is no need to change the display contrast; however, should you wish to do so, press **Setup**, touch , touch **Screen Contrast**, and follow the direction on the screen.

PAGE FORWARD AND BACK

The Page FORWARD  and Page BACK  pads on the Control Panel allow you to scroll the touchscreen forward and backward when these symbols appear in the banner of the display. These symbols appear primarily on the recipe screens and allow you to look at the entire recipe before beginning preparation. You will also see the  symbol when you have selected Custom Help or have made a mistake. Touching this pad will return the display to the previous screen.

3 MINUTE PLUS

For the lower oven, if you select **Timed Cook** for Bake, Convection Bake manual timing or Convection Roast manual timing, the **3 Minute Plus** pad will appear in the lower right-hand corner of the display. The **3 Minute Plus** pad allows you to add to the set cooking time in 3 minute intervals. Each time you touch the **3 Minute Plus** pad, the countdown time will be extended by 3 minutes. The 3 Minute Plus option will only appear when you have selected **Timed Cook** (oven turns off automatically after the set cooking time).

CLEANING AND CARE

Before cleaning any part of the range, be sure all controls are turned OFF and all surfaces are cool.

NON-COOKTOP SURFACES

EXTERIOR

The outside surface is precoated metal and plastic. Clean the outside with mild soap and water; rinse and dry with a soft cloth. Do not use any type of household or abrasive cleaner.

STAINLESS STEEL SURFACE (SELECT MODELS)

The exterior should be wiped often with a soft damp cloth and polished with a soft dry cloth to maintain its beauty. There are also a variety of products designed especially for cleaning and shining the stainless exterior of the oven. We recommend that the cleaner be applied to a soft cloth and then carefully used on the stainless exterior rather than sprayed directly on to it. Follow package directions carefully.

OUTSIDE OF THE DOOR

Wipe the window on both sides with a soft damp cloth to remove any spills or splatters. Metal parts will be easier to maintain if wiped frequently with a soft damp cloth. Avoid the use of spray and other harsh cleaners as they may stain, streak or dull the door surface.

CONTROL KNOBS

The control knobs may be removed for easier cleaning. Before removing the knobs, make sure the knobs are in the OFF position. Clean with a soft cloth dampened with mild soap and water; rinse and dry with a soft cloth. When replacing the knobs, check the OFF position to insure proper placement.

TOUCH CONTROL PANEL

If desired, the touch pads may be deactivated before cleaning. See the Control Lock information on page 40 of this manual. Wipe the panel with a cloth dampened slightly with water only. Dry with a soft cloth. Do not scrub or use any sort of chemical cleaners. Close door and touch **Stop/Clear**.

COOKTOP

If the cooktop should crack or break, do not use or attempt to clean it. Call an authorized servicer.

NORMAL DAILY USE CLEANING

Only use cleaning products that have been specifically designed for glass ceramic cooktops. Read and follow all instructions and warnings on the cleaning cream label. A sample cleaner cream is supplied with your range.

Before using the cooktop, clean the cooktop with the cleaner cream. To avoid possible damage to the cooking surface, do not apply cleaning cream to the glass surface when it is hot.

We recommend that you avoid wiping any surface unit areas until they have cooled and the hot surface indicator light has

gone off. Sugar spills are the exception to this.

1 Apply a few drops of cleaner cream to the cooktop that is not hot.

2 Dampen clean paper towel and clean top.

3 Wipe off with another clean, damp paper towel, then wipe dry.

Note:

- Make sure bottom of cookware and cooking area are clean and dry before turning on the cooktop.
- Wipe up food spills and splatters before they burn on the surface.
- Do not mix cleaning products. Mixtures may interact and damage the surface.

SUGARY SPILLOVERS (JELLIES, FUDGE, CANDY, SYRUPS ETC.), MELTED PLASTICS OR HEAVY BURNED ON RESIDUE

Sugary spillovers, melted plastics or heavy burned on residue can cause pitting of the surface of your cooktop unless the spill is removed while still hot.

You must begin cleaning the spills while the cooktop is still hot.

1 Turn off all surface units and remove all pans immediately.

2 Wearing an oven mitt, use a razor blade scraper at a 30 degree angle against the glass ceramic surface and scrape from hot surface to a cooler area.

3 Remove the spills with paper towels.

Note:

- Do not use a dull or nicked blade. Be sure to use a new, sharp razor scraper.
- Do not use the razor blade for daily cleaning as it may wear the pattern on the glass.

METAL MARKS OR BURNED ON RESIDUE

Metal marks and burned on residue should be removed immediately after the cooktop has cooled. Metal marks can become permanent if not removed prior to future use.

1 Dampen a “scratchless” or “never scratch” pad that is safe for non-stick cookware. The pattern and glass will be damaged if the pad is not damp or is soiled or if another type of pad is used. Apply a cleaner cream for glass ceramic cooktops.

2 Scrub to remove as much soil as possible.

3 Apply the cleaner cream over the soil, cover with a damp paper towel and let stand 30 minutes to 1 hour. Keep moist by covering the paper towel with plastic wrap.

4 Scrub again and wipe off with another clean, damp paper towel. Then wipe dry.

Note:

- Do not use aluminum foil on the cooktop.
- If pots or pans of aluminum or copper are allowed to

boil dry, permanent damage may affect the ceramic glass surface.

- Do not slide pots and pans across the cooktop surface.
- Cookware with rough bottoms can mark or scratch the cooktop surface.
- Do not use a dull or nicked blade. Be sure to use a new, sharp razor scraper.

MICROWAVE DRAWER

INTERIOR

Cleaning is easy because no heat is generated to the interior surfaces; therefore, there is no baking and setting of spills or spattering. To clean the interior surfaces, including drawer sealing surfaces, wipe with a soft damp cloth. **DO NOT USE ABRASIVE OR HARSH CLEANERS OR SCOURING PADS.** For heavier soil, use mild soap; wipe clean with a soft damp cloth. Do not use any chemical oven cleaners.

MICROWAVE DRAWER GUIDES

Remove the food crumbs from the Microwave Drawer guides. Wipe with a soft dry cloth in order to keep the Microwave Drawer opening and closing easily.

WAVEGUIDE COVER

ATTENTION The waveguide cover (located on the inside top of the microwave drawer area) is made from mica, so it requires special care. Keep the waveguide cover clean to assure good microwave performance. Carefully wipe with a soft damp cloth any food spatters from the surface of the cover immediately after they occur. Built-up splashes may overheat and cause smoke or possibly catch fire. Do not remove the waveguide cover.

ODOR REMOVAL

Occasionally, a cooking odor may remain in the Microwave Drawer. To remove, combine 1 cup water, grated peel and juice of one lemon and several whole cloves in a 2-cup glass measuring cup. Boil for several minutes using 100% power. Allow to sit in the Microwave Drawer until cool. Wipe interior with a soft cloth.

OVEN

CAUTION Before cleaning any part of the oven, be sure the oven is turned off. If not, Touch **Stop/Clear**.

Allow the oven to cool before cleaning.

INSIDE OF THE DOOR

You do not need to clean the area inside the gasket by hand since the area is cleaned during the self-clean cycle.

Do not rub, clean or move the door gasket. Replace gasket when it is worn or frayed.

The area outside the gasket and the door liner can be cleaned with a soap-filled steel wool or plastic pad, hot water and

detergent. Rinse well with a vinegar and water solution.

INSIDE OF THE OVEN (SELF-CLEANING)

See page 39.

REMOVE AND REPLACE OVEN DOOR

1 Open the door to the fully opened position.

2 Pull the lock located on both hinge supports up and engage in the hook of the hinge levers. You may have to apply a little downward pressure on the door to pull the locks fully over the hooks.

3 Grab the door by the sides, pull the bottom of the door up and toward you to disengage the hinge supports. Keep pulling the bottom of the door toward you while rotating the top of the door toward the range to completely disengage the hinge levers.

4 Proceed in reverse to reinstall the door.

Make sure the hinge supports are fully engaged before unlocking the hinge levers.

CAUTION The door is very heavy. For safe, temporary storage, lay the door flat with the inside of the door facing down.

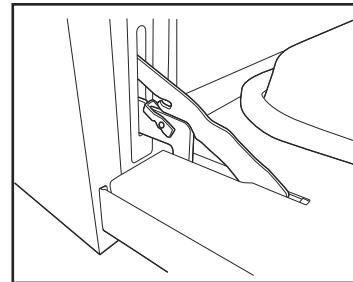

Lock in normal position.

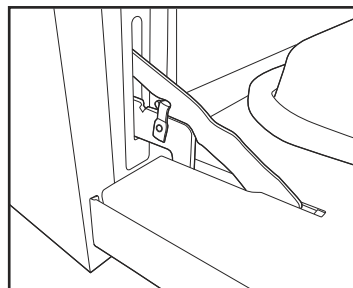

Lock engaged for door removal.

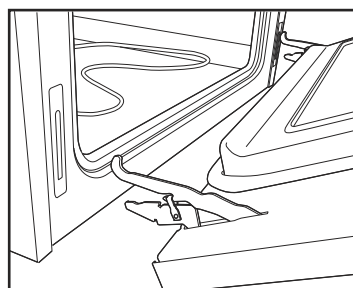

Door removed from the range.

CLEANING AND CARE

OVEN RACKS

Clean with soap and water, rinse and polish dry.

To remove stubborn soil, use an abrasive cleanser or steel wool. After cleaning, rinse the racks with clean water and dry with a clean cloth.

Note:

- If the racks become hard to slide, apply a small amount of cooking oil to a paper towel and wipe on the edges of the oven racks.
- Do not leave in oven during self-cleaning cycle.

BROILER PAN, GRID AND ROAST/BROIL RACK

Remove from oven at end of roasting or broiling. Drain away fats and accumulated juices. Sprinkle the grid with detergent and cover with wet paper towels or wet dish cloth. Allow to cool.

Wash in hot soapy water and scrub any remaining food particles with a soap filled pad or plastic scouring pad. Rinse and polish dry with a soft cloth.

The broiler pan, grid and roast/broil rack can be washed in the dishwasher.

Note:

- Do not leave in oven during self cleaning cycle.

OVEN LIGHT REPLACEMENT

CAUTION Be sure the oven is unplugged and all parts are COOL before replacing the oven lightbulb. Do not turn the oven light on during the self-cleaning cycle. The high temperature will reduce lamp life.

The interior oven light will turn on automatically when the oven door is opened.

The oven light may be turned on when the door is closed by using the oven light switch located on the control panel.

The bulb is covered with a glass shield held in place by a wire holder.

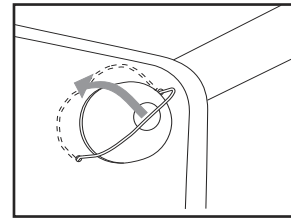

This glass shield must be in place whenever the oven is in use.

TO REPLACE THE LIGHT BULB

- 1** Turn the power off at the main source.
- 2** Wear a glove with leather palm for protection against possible broken glass.
- 3** Replace bulb with a 40 watt appliance bulb only.
- 4** Press wire holder to one side to release glass shield. Replace glass shield.

BEFORE YOU CALL FOR SERVICE

Please check the following before calling for service. It may save you time and expense.

PROBLEM	POSSIBLE CAUSE	SOLUTION
1 Part or all of range does not operate.	<ul style="list-style-type: none"> • Power cord of range is not completely connected to the electrical outlet. • Power outage. • Fuse/circuit breaker at home doesn't work. • Range is in Demo Mode. 	<ul style="list-style-type: none"> • Make sure the power cord is tightly connected to the outlet. • Check house lights to be sure. Call your local electric company for service. • Replace the fuse or reset the circuit breaker. • See page 41 for how to cancel Demo Mode.
2 Surface units do not heat.	<ul style="list-style-type: none"> • No power to the appliance. • Surface controls improperly set. 	<ul style="list-style-type: none"> • See SOLUTION for PROBLEM 1. • Check if the controls have been properly set. See page 15.
3 Surface units too hot or not hot enough.	<ul style="list-style-type: none"> • Improper cookware being used. 	<ul style="list-style-type: none"> • Use pans which are flat and match the diameter of the surface unit selected.
4 Surface unit stops glowing.	<ul style="list-style-type: none"> • It is normal when turned to a lower setting. 	
5 Scratches on glass ceramic cooktop.	<ul style="list-style-type: none"> • Incorrect cleaning methods were used. • Cookware with rough bottom has been used. 	<ul style="list-style-type: none"> • Use the recommended cleaning procedure. See page 42-43. • Use smooth, flat-bottomed cookware.
6 Areas of discoloration on the cooktop.	<ul style="list-style-type: none"> • Food spillovers not cleaned before next use. 	<ul style="list-style-type: none"> • Use the recommended cleaning procedure. See page 42-43.
7 Metal marks on cooktop.	<ul style="list-style-type: none"> • Sliding or scraping of metal pans on top. 	<ul style="list-style-type: none"> • Do not slide metal pans. When cool, clean with cooktop cleaning cream to remove the marks.
8 Brown streaks or specks on cooktop glass surface.	<ul style="list-style-type: none"> • Boilovers are cooked onto surface. 	<ul style="list-style-type: none"> • Use the recommended cleaning procedure. See page 42-43.
9 Food in Microwave Drawer is not heated.	<ul style="list-style-type: none"> • No power to the appliance. • Drawer controls improperly set. • Range is in Demo Mode. 	<ul style="list-style-type: none"> • See SOLUTION for PROBLEM 1. • Check if the controls have been properly set. See page 18-19. • See page 41.
10 Microwave Drawer light does not work.	<ul style="list-style-type: none"> • Light bulb is loose or burned out. 	<ul style="list-style-type: none"> • Call for service.
11 Oven does not work.	<ul style="list-style-type: none"> • No power to the appliance. • Oven controls improperly set. • Oven too hot. • Range is in Demo Mode. 	<ul style="list-style-type: none"> • See SOLUTION for PROBLEM 1. • Check if the controls have been properly set. See page 30-38. • Allow the oven to cool below locking temperature and then reset to the desired setting/temperature. • See page 41.
12 Oven light does not work.	<ul style="list-style-type: none"> • Light bulb is loose or burned out. 	<ul style="list-style-type: none"> • Tighten or replace the bulb.
13 Touch controls will not operate.	<ul style="list-style-type: none"> • Control Lock is on. 	<ul style="list-style-type: none"> • See page 40 to unlock.

BEFORE YOU CALL FOR SERVICE

PROBLEM	POSSIBLE CAUSE	SOLUTION
14 Lower oven will not open.	<ul style="list-style-type: none"> Lower oven door is locked. 	<ul style="list-style-type: none"> See page 41 to unlock oven door. See 18 below.
15 Poor baking results.	<ul style="list-style-type: none"> Oven controls improperly set. Rack position is incorrect. Incorrect cookware is used. Pan warped. Oven thermostat needs adjustment. Range not level. Oven door opened too frequently. 	<ul style="list-style-type: none"> Check if the controls have been properly set. See page 30. See page 29. Use cookware suggested in recipe. Do not use pans that are dented or warped. See page 41. Place a marked glass measuring cup filled with water on the center of the oven rack. If the water level is uneven, refer to the Installation Manual for leveling the range. Open oven door only after shortest recommended baking time. Use Oven Light pad to see the food in the oven.
16 Food does not broil properly or smokes excessively.	<ul style="list-style-type: none"> Oven controls improperly set. Improper rack position being used. Aluminum foil was incorrectly used. For Conventional Broil, oven door was closed during broiling. For Convection Broil, oven door was not closed during broiling. 	<ul style="list-style-type: none"> Check if the controls have been properly set. See page 33. See page 34. See page 29. Leave the door open to broil stop position when using Conventional Broil. Leave the door closed when using Convection Broil.
17 Self-cleaning cycle does not work.	<ul style="list-style-type: none"> The oven temperature is too high to set a self-cleaning cycle. Oven controls improperly set. 	<ul style="list-style-type: none"> Allow the oven to cool and reset the controls. Check if the controls have been properly set. See page 39.
18 Oven door does not open after a clean cycle.	<ul style="list-style-type: none"> Oven too hot. 	<ul style="list-style-type: none"> Allow the oven to cool below locking temperature.
19 Strong odor or light smoke when range is turned on.	<ul style="list-style-type: none"> This is normal for a new range. Excessive food soils on the oven bottom. 	<ul style="list-style-type: none"> It will disappear after a few uses. Ventilate the room to remove odors more quickly. Use a self-cleaning cycle. See page 39.
20 Display intermittently shows Video Demo and Set Clock.	<ul style="list-style-type: none"> Power failure. 	<ul style="list-style-type: none"> Touch Set Clock pad on the display and follow the directions. If the oven was in use, you must reset the cooking function.
21 Steam from the vent.	<ul style="list-style-type: none"> When using the bake or microwave feature, it is normal to see steam from the food coming out of the vent. 	

For more complete information and safety precautions, refer to your Operation Manual.

MICROWAVE DRAWER

SET DATE AND TIME

If the range has just been plugged in, touch **Set Clock** on the screen and follow the directions. To reset the clock, touch **Setup** pad on the control panel.

- 1 Touch **Clock** pad, enter the correct month by touching **Month** repeatedly. Touch **ENTER**.
- 2 Touch number pads for correct date and touch **ENTER**.
- 3 Touch number pads for correct time. Select AM/PM and then touch **ENTER**.

MANUAL OPERATION

High Power Cooking

- 1 Touch number pads on the control panel to enter the cooking time.
- 2 Touch **START**.

Variable Power Cooking

- 1 Touch number pads on the control panel to enter the cooking time.
- 2 Touch **Power Level** pad continuously for desired power level.
- 3 Touch **START**.

REHEAT

- 1 Touch **Reheat** pad on the screen.
- 2 Select the desired food.
- 3 Follow directions on the screen.

POPCORN

- 1 Touch **Microwave Drawer** pad on the control panel or **Micro Cook** pad on the screen, then touch **Popcorn** pad on the screen.
- 2 Select the desired type of popcorn from the screen.
- 3 Follow directions on the screen.

AUTOMATIC COOKING

- 1 Touch **Microwave Drawer** pad on the control panel or **Micro Cook** pad on the screen, then touch **Automatic Cooking**.
- 2 Select the desired food from the screen.
- 3 Follow directions on the screen.

DEFROST

- 1 Touch **Microwave Drawer** pad on the control panel or touch **Defrost** pad on the screen.
- 2 Select the desired food from the screen.
- 3 Follow directions on the screen.

KEEP WARM

- 1 Touch **Microwave Drawer** pad on the control panel or **Micro Cook** pad on the screen, then touch **Keep Warm** pad on the screen.
- 2 Touch number pads on the control panel to enter the Keep Warm time.
- 3 Touch **START**.

MINUTE PLUS

Minute Plus allows you to cook for one minute at 100% power with each touch. There are several ways to access the **Minute Plus** pad.

- 1 Touch **START/Minute Plus** pad on the control panel.
- 2 Touch **Microwave Drawer** pad on the control panel, then touch **Minute Plus** pad on the screen.
- 3 Touch **Micro Cook** pad on the screen, then **Minute Plus** pad will appear on the next screen.

MORE/LESS TIME ADJUSTMENT

To adjust the cooking time to your individual preference.

- 1 Select microwave desired options.
- 2 Follow directions on the screen.
- 3 The **More/Less** pad will appear at the count down time. Touch once for More, twice of Less.

AUTO-TOUCH GUIDE

For more complete information and safety precautions, refer to your Operation Manual.

LOWER OVEN

BAKE

- 1 Touch **Bake** pad on the screen.
- 2 Touch number pads or pre-set pads for desired temperature.
- 3 Touch **START**.

When the oven reaches the programmed temperature, a signal will sound.

BROIL

- 1 Touch **Broil** pad on the screen.
- 2 Select the desired setting.
- 3 Touch **START**.

CONVECTION BAKE

- 1 Touch **Lower Oven** pad on the control panel, then touch **Convection Bake** pad on the screen or touch **Convection** pad on the screen, then touch **Convection Bake** pad.
- 2 Select the desired setting.
- 3 Follow the directions.

CONVECTION ROAST

- 1 Touch **Lower Oven** pad on the control panel, then touch **Convection Roast** pad on the screen or touch **Convection** pad on the screen, then touch **Convection Roast** pad.
- 2 Select the desired setting.
- 3 Follow the directions.

CONVECTION BROIL

- 1 Touch **Lower Oven** pad on the control panel, then touch **Convection Broil** pad on the screen or touch **Convection** pad on the screen, then touch **Convection broil** pad.
- 2 Touch **START**.

SELF CLEAN

- 1 Touch **Lower Oven** pad on the control panel, then touch **Self Clean** pad on the screen
- 2 Select the desired setting.
- 3 Follow the directions.

OTHER FEATURES

KITCHEN TIMER

- 1 Touch **Kitchen Timer** pad on the control panel.
- 2 Select the desired setting.
- 3 Follow the directions.

To cancel Kitchen Timer, touch and hold the **Kitchen Timer** pad for 3 seconds.

CONTROL LOCK

The Control Lock prevents unwanted oven/drawer operation such as by small children. The oven and Microwave Drawer can be set so that the control panel is deactivated or locked.

To Lock

With Home Screen showing, touch **Control Lock** [2] pad on the control panel and hold for 3 seconds.

To Unlock

With Home Screen showing, touch **Control Lock** [2] pad on the control panel and hold for 3 seconds.

OVEN LIGHT

Touch the **Oven Light** pad on the control panel to turn the light on or off.

SETUP

The Setup has ten functions. Check operation manual for specific details.

Clock	Delay Start
Sound Adjustment	Continuous Reminder
Lock Lower Oven	12 Hour Shut Down
Video Demo	Demo Mode
Adjust Oven Temperature	Screen Contrast