



SHARP®

Carousel®

OVER THE RANGE MODEL

R-1514 (Stainless)

microwave
cooking
guide

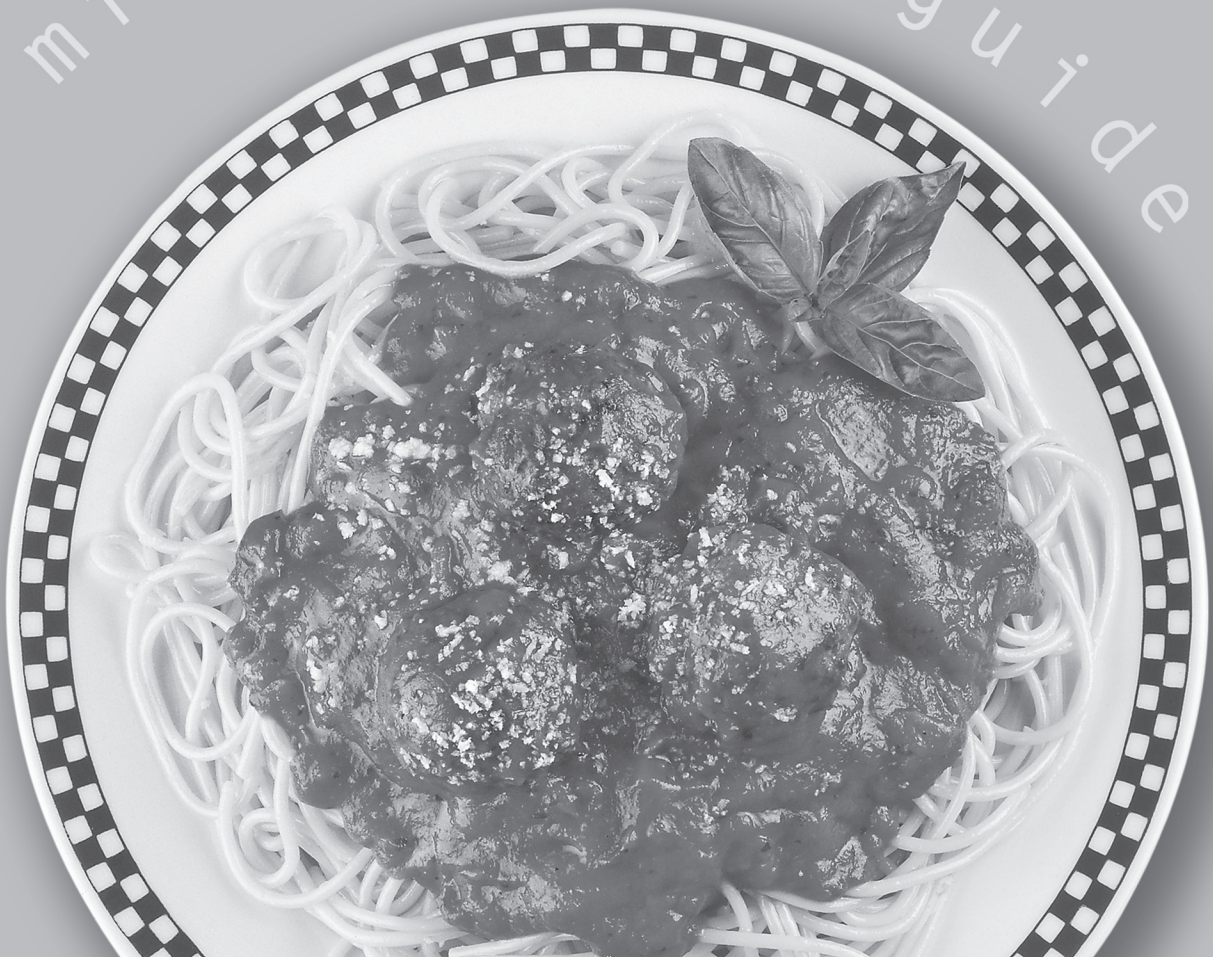



CUSTOMER ASSISTANCE

UNITED STATES ONLY

REGISTER YOUR PRODUCT

Registering your new product is easy and offers benefits that help you get the most out of your Sharp product including:

- ✓ **Convenience:** If you ever need warranty support, your product information is already on file.
- ✓ **Communication:** Stay up to date with important notifications and special offers from SHARP.
- ✓ **Support:** Quickly access support content including Owners Manuals, FAQ's, How-to Videos, and much more.

3 EASY WAYS TO REGISTER TODAY!

 <p>SCAN Use the camera or QR code scanning application on your smart phone</p> <p>Scan this QR Code on your smart phone</p>	 <p>ONLINE Visit our sites to learn more about your product at sharpusa.com and sbl.sharpusa.com</p> <p>Visit http://www.sharpusa.com/register</p>	 <p>CALL US US 800-BE-SHARP 800-237-4277 Mon-Fri: 7am-7pm CST Sat-Sun: 9am-7pm CST</p> <p>Contact a Sharp Advisor on the phone</p>
--	---	--

PRODUCT SUPPORT



If you have questions about the setup or operation of your product, please refer to the corresponding section within this manual.

Additionally, visit www.sharpusa.com/support to access exclusive content about your product including:

- FAQ's and How-To Videos
- Find or Request Service
- Purchase an Extended Warranty
- Downloads including the Installation Guide, Spec Sheet, and Owner's Manual

CONTACT US

If at any time you have questions or comments concerning your SHARP product, please contact the SHARP Customer Assistance Center. We are available to assist you through multiple contact methods for your convenience:

 <p>EMAIL Available 24/7 US: sharpusa.com</p> <p>See the Contact Us section on our sites</p>	 <p>CHAT ONLINE Mon-Fri: 7am-7pm CST Sat-Sun: 9am-7pm CST</p> <p>U.S. www.sharpusa.com/support</p>	 <p>CALL US US 800-BE-SHARP 800-237-4277 Mon-Fri: 7am-7pm CST Sat-Sun: 9am-7pm CST</p> <p>Contact a Sharp Advisor on the phone</p>
--	--	--





CONTENTS

Customer Assistance	2	Special Features	14-20
Precautions to Avoid Possible Exposure to Excessive Microwave Energy	3	Instant Sensor	15
Contents	3	Sensor Cook Center	16
Consumer Limited Warranty	4	Sensor Cook Recipes.....	17
Important Safety Instructions	5	Reheat	18
Unpacking Instructions	6	Defrost Center	19
Optional Accessories	6	Keep Warm Plus	20
Electrical Grounding Instructions	6	Hot Water	20
Information You Need to Know	7-9	Other Convenient Features	21-22
About Your Oven	7	Custom Help	21
About Food.....	7	Help.....	21
About Utensils And Coverings.....	8	Demonstration Mode.....	21
Do Not Use.....	8	Multiple Sequence Cooking	22
About Children And The Microwave.....	8	Timer	22
About Microwave Cooking	9	More or Less Time Adjustment	22
About Safety.....	9	Minute Plus	22
Part Names	10	Light Hi/lo	22
Before Operating	12	Fan Hi/lo.....	22
To Set the Clock	12	Cleaning And Care	23
STOP/CLEAR	12	Replacing Parts	24
Manual Operation	13	Service Call Check	25
Time Cooking	13	Specifications	25
To Set Power Level	13	Vegetable Cooking Chart	26-27
Manual Defrost.....	13	Reheating Chart	28
		Poultry Roasting Chart	29
		Guia Auto-Touch	30-31
		Auto-Touch Guide	31-Back Cover

PRECAUTIONS TO AVOID POSSIBLE EXPOSURE TO EXCESSIVE MICROWAVE ENERGY

- (a) Do not attempt to operate this oven with the door open since open-door operation can result in harmful exposure to microwave energy. It is important not to defeat or tamper with the safety interlocks.
- (b) Do not place any object between the oven front face and the door or allow soil or cleaner residue to accumulate on sealing surfaces.
- (c) Do not operate the oven if it is damaged. It is particularly important that the oven door close properly and that there is no damage to the: (1) door (bent), (2) hinges and latches (broken or loosened), (3) door seals and sealing surfaces.
- (d) The oven should not be adjusted or repaired by anyone except properly qualified service personnel.





CONSUMER LIMITED WARRANTY

SHARP ELECTRONICS CORPORATION warrants to the first consumer purchaser that this Sharp brand product (the "Product"), when shipped in its original container, will be free from defective workmanship and materials, and agrees that it will, at its option, either repair the defect or replace the defective Product or part thereof with a new or remanufactured equivalent at no charge to the purchaser for parts or labor for the period(s) set forth below.

This warranty does not apply to any appearance items of the Product nor to the additional excluded item(s) set forth below nor to any Product the exterior of which has been damaged or defaced, which has been subjected to misuse, abnormal service or handling, or which has been altered or modified in design or construction.

In order to enforce the rights under this limited warranty, the purchaser should follow the steps set forth below and provide proof of purchase to the servicer.

The limited warranty described herein is in addition to whatever implied warranties may be granted to purchasers by law. ALL IMPLIED WARRANTIES INCLUDING THE WARRANTIES OF MERCHANTABILITY AND FITNESS FOR USE ARE LIMITED TO THE PERIOD(S) FROM THE DATE OF PURCHASE SET FORTH BELOW. Some states do not allow limitations on how long an implied warranty lasts, so the above limitation may not apply to you.

Neither the sales personnel of the seller nor any other person is authorized to make any warranties other than those described herein, or to extend the duration of any warranties beyond the time period described above on behalf of Sharp.

The warranties described herein shall be the sole and exclusive warranties granted by Sharp and shall be the sole and exclusive remedy available to the purchaser. Correction of defects, in the manner and for the period of time described herein, shall constitute complete fulfillment of all liabilities and responsibilities of Sharp to the purchaser with respect to the Product, and shall constitute full satisfaction of all claims, whether based on contract, negligence, strict liability or otherwise. In no event shall Sharp be liable, or in any way responsible, for any damages or defects in the Product which were caused by repairs or attempted repairs performed by anyone other than an authorized servicer. Nor shall Sharp be liable or in any way responsible for any incidental or consequential economic or property damage. Some states do not allow the exclusion of incidental or consequential damages, so the above exclusion may not apply to you.

THIS LIMITED WARRANTY IS VALID ONLY IN THE FIFTY (50) UNITED STATES, THE DISTRICT OF COLUMBIA AND PUERTO RICO.

Your Product Model Number & Description:

R-1514 Home Use Carousel™ Microwave Oven. (Be sure to have this information available when you need service for your Product.)

Warranty Period for this Product:

One (1) year parts and labor in-home service. The warranty period continues for an additional six (6) years, for a total of seven (7) years, with respect to the magnetron tube in the Product for parts only. Labor and the servicer trip charge are not provided free of charge for this additional period.

Additional Item(s) Excluded from Warranty Coverage (if any):

Non-functional accessories, turntable and light bulbs.

Where to Obtain Service:

From a Sharp Authorized Servicer located In the United States. Be sure to have **Proof of Purchase** available. For in-home service, the servicer will come to the unit's location. If it is necessary to remove the unit for repair, the servicer will reinstall the unit at no extra charge, provided it was installed according to Sharp's Installation Instructions. To find the location of the nearest Sharp Authorized Servicer, call Sharp toll free at 1-800-BE-SHARP (1-800-237-4277).

TO OBTAIN SUPPLY, ACCESSORY OR PRODUCT INFORMATION, CALL **1-800-BE-SHARP** OR VISIT www.sharppusa.com.
SAVE THE PROOF OF PURCHASE AS IT IS NEEDED SHOULD YOUR OVEN EVER REQUIRE WARRANTY SERVICE.





IMPORTANT SAFETY INSTRUCTIONS

When using electrical appliances basic safety precautions should be followed, including the following:

WARNING - To reduce the risk of burns, electric shock, fire, injury to persons or exposure to excessive microwave energy:

1. **READ ALL INSTRUCTIONS BEFORE USING THE APPLIANCE.**
 2. Read and follow the specific “**PRECAUTIONS TO AVOID POSSIBLE EXPOSURE TO EXCESSIVE MICROWAVE ENERGY**” on page 3.
 3. This appliance must be grounded. Connect only to properly grounded outlet. See “**ELECTRICAL GROUNDING INSTRUCTIONS**” on page 6.
 4. Install or locate this appliance only in accordance with the provided installation instructions.
 5. Some products such as whole eggs and sealed containers—for example, closed glass jars—are able to explode and should not be heated in this oven.
 6. Use this appliance only for its intended use as described in this manual. Do not use corrosive chemicals or vapors in this appliance. This type of oven is specifically designed to heat, cook or dry food. It is not designed for industrial or laboratory use.
 7. As with any appliance, close supervision is necessary when used by children.
 8. Do not operate this appliance if it has a damaged cord or plug, if it is not working properly or if it has been damaged or dropped.
 9. This appliance should be serviced only by qualified service personnel. Contact nearest Sharp Authorized Servicer for examination, repair or adjustment.
 10. Do not cover or block any openings on the appliance.
 11. Do not store or use this appliance outdoors. Do not use this product near water—for example, near a kitchen sink, in a wet basement or near a swimming pool, or similar locations.
 12. Do not immerse cord or plug in water.
 13. Keep cord away from heated surfaces.
 14. Do not let cord hang over edge of table or counter.
 15. See door surface cleaning instructions on page 23.
 16. To reduce the risk of fire in the oven cavity:
 - a. Do not overcook food. Carefully attend appliance when paper, plastic or other combustible materials are placed inside the oven to facilitate cooking.
 - b. Remove wire twist-ties from paper or plastic bags before placing bag in oven.
 - c. **If materials inside the oven should ignite, keep oven door closed, turn oven off and disconnect the power cord or shut off power at the fuse or circuit breaker panel.**
 - d. Do not use the cavity for storage purposes. Do not leave paper products, cooking utensils or food in the cavity when not in use.
17. Liquids, such as water, coffee or tea are able to be overheated beyond the boiling point without appearing to be boiling. Visible bubbling or boiling when the container is removed from the microwave oven is not always present. **THIS COULD RESULT IN VERY HOT LIQUIDS SUDDENLY BOILING OVER WHEN A SPOON OR OTHER UTENSIL IS INSERTED INTO THE LIQUID.**
To reduce the risk of injury to persons:
- a. Do not overheat the liquid.
 - b. Stir the liquid both before and halfway through heating it.
 - c. Do not use straight-sided containers with narrow necks. Use a wide-mouthed container.
 - d. After heating, allow the container to stand in the microwave oven at least for 20 seconds before removing the container.
 - e. Use extreme care when inserting a spoon or other utensil into the container.
18. Clean ventilation openings and grease filters frequently—Grease should not be allowed to accumulate on ventilation openings, louver or grease filters.
19. Use care when cleaning the louver and the grease filters. Corrosive cleaning agents, such as lye-based oven cleaners, may damage the louver and the grease filters.
20. When flaming food under the hood, turn the fan on.
21. This appliance is suitable for use above both gas and electric cooking equipment 36” wide or less.

SAVE THESE INSTRUCTIONS





UNPACKING INSTRUCTIONS

Open the bottom of the carton, bend the carton flaps back and tilt the oven over to rest on plastic foam pad. Lift carton off oven and remove all packing materials, WALL and TOP CABINET TEMPLATE, Turntable, and Turntable Support. SAVE THE CARTON AS IT MAY MAKE INSTALLATION EASIER.

1. Remove the feature sticker from the outside of the door, if there is one.
2. DO NOT REMOVE THE WAVEGUIDE COVER, which is located on the right side wall of the oven cavity. Check to see that there is a WALL TEMPLATE and TOP CABINET TEMPLATE. Read enclosures and SAVE the Operation Manual.

Check the oven for any damage, such as misaligned or bent door, damaged door seals and sealing surfaces, broken or loose door hinges and latches and dents inside the cavity or on the door. If there is any damage, do not operate the oven and contact your dealer or SHARP AUTHORIZED SERVICER. See Installation Instructions for more details.

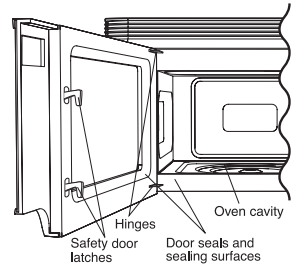

OPTIONAL ACCESSORIES

Charcoal Filter (RK-240). This is required when hood exhaust is recirculated. See Charcoal Filter on page 24. If dealer does not stock this item, it can be ordered by calling 1-800-BE-SHARP (237-4277).

To purchase contact: Sharp Electronics Corporation
 Customer Assistance Center
 Sharp Plaza Blvd
 Memphis, Tennessee 38193
 Phone: 1-800-BE-SHARP (237-4277)

ELECTRICAL GROUNDING INSTRUCTIONS

This appliance must be grounded. This oven is equipped with a cord having a grounding wire with a grounding plug. It must be plugged into a wall receptacle that is properly installed and grounded in accordance with the National Electrical Code and local codes and ordinances. In the event of an electrical short circuit, grounding reduces risk of electric shock by providing an escape wire for the electric current.

WARNING - Improper use of the grounding plug can result in a risk of electric shock.

Electrical Requirements

The oven is equipped with a 3-prong grounding plug. DO NOT UNDER ANY CIRCUMSTANCES CUT OR REMOVE THE GROUNDING PIN FROM THE PLUG.

The Power Supply Cord and plug must be connected to a separate 120 Volt AC, 60 Hz, 15 Amp, or more branch circuit, single grounded receptacle. The receptacle should be located inside the cabinet directly above the Microwave Oven mounting location.

NOTE:

1. If you have any questions about the grounding or electrical instructions, consult a qualified electrician or serviceworker.
2. Neither Sharp nor the dealer can accept any liability for damage to the oven or personal injury resulting from failure to observe the correct electrical connection procedures.

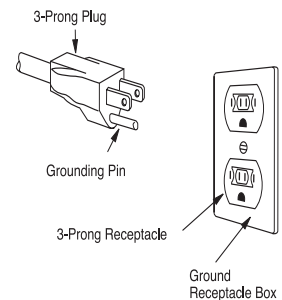

Radio or TV Interference

Should there be any interference caused by the microwave oven to your radio or TV, check that the microwave oven is on a different electrical circuit, relocate the radio or TV as far away from the oven as feasible or check position and signal of receiving antenna.



INFORMATION YOU NEED TO KNOW

ABOUT YOUR OVEN

This Operation Manual is valuable: read it carefully and always save it for reference.

NEVER use the oven without the turntable and support nor turn the turntable over so that a large dish could be placed in the oven. The turntable will turn both clockwise and counterclockwise.

ALWAYS have food in the oven when it is on to absorb the microwave energy.

When using the oven at power levels below 100%, you may hear the magnetron cycling on and off. It is normal for the exterior of the oven to be warm to the touch when cooking or reheating.

Condensation is a normal part of microwave cooking. Room humidity and the moisture in food will influence the amount of moisture that condenses in the oven. Generally, covered foods will not cause as much condensation as uncovered ones. Ventilation openings must not be blocked.

The oven is for food preparation only. It should not be used to dry clothes or newspapers.

All ovens are rated 1000 watts by using the IEC Test Procedure. In using recipes or package directions, check food a minute or two before the minimum time and add time accordingly.

ABOUT FOOD

FOOD	DO	DON'T
Eggs, sausages, nuts, seeds, fruits & vegetables	<ul style="list-style-type: none"> Puncture egg yolks before cooking to prevent "explosion". Pierce skins of potatoes, apples, squash, hot dogs and sausages so that steam escapes. 	<ul style="list-style-type: none"> Cook eggs in shells. Reheat whole eggs. Dry nuts or seeds in shells.
Popcorn	<ul style="list-style-type: none"> Use specially bagged popcorn for the microwave oven. Listen while popping corn for the popping to slow to 1 or 2 seconds or use special POPCORN pad. 	<ul style="list-style-type: none"> Pop popcorn in regular brown bags or glass bowls. Exceed maximum time on popcorn package.
Baby food	<ul style="list-style-type: none"> Transfer baby food to small dish and heat carefully, stirring often. Check temperature before serving. Put nipples on bottles after heating and shake thoroughly. "Wrist" test before feeding. 	<ul style="list-style-type: none"> Heat disposable bottles. Heat bottles with nipples on. Heat baby food in original jars.
General	<ul style="list-style-type: none"> Cut baked goods with filling after heating to release steam and avoid burns. Stir liquids briskly before and after heating to avoid "eruption". Use deep bowl, when cooking liquids or cereals, to prevent boilovers. 	<ul style="list-style-type: none"> Heat or cook in closed glass jars or air tight containers. Can in the microwave as harmful bacteria may not be destroyed. Deep fat fry. Dry wood, gourds, herbs or wet papers.





INFORMATION YOU NEED TO KNOW

ABOUT UTENSILS AND COVERINGS

It is not necessary to buy all new cookware. Many pieces already in your kitchen can be used successfully in your new microwave oven. Make sure the utensil does not touch the interior walls during cooking.

Use these utensils for safe microwave cooking and reheating:

- glass ceramic (Pyroceram®), such as Corningware®.
- heat-resistant glass (Pyrex®)
- microwave-safe plastics
- paper plates
- microwave-safe pottery, stoneware and porcelain
- browning dish (Do not exceed recommended preheating time. Follow manufacturer's directions.)

These items can be used for short time reheating of foods that have little fat or sugar in them:

- wood, straw, wicker

DO NOT USE

- metal pans and bakeware
- dishes with metallic trim
- non-heat-resistant glass
- non-microwave-safe plastics (margarine tubs)
- recycled paper products
- brown paper bags
- food storage bags
- metal twist-ties

Should you wish to check if a dish is safe for microwaving, place the empty dish in the oven and microwave on HIGH for 30 seconds. A dish which becomes very hot should not be used.

ABOUT CHILDREN AND THE MICROWAVE

Children below the age of 7 should use the microwave oven with a supervising person very near to them. Between the ages of 7 and 12, the supervising person should be in the same room.

The child must be able to reach the oven comfortably; if not, he/she should stand on a sturdy stool.

At no time should anyone be allowed to lean or swing on the oven door.

The following coverings are ideal:

- Paper towels are good for covering foods for reheating and absorbing fat while cooking bacon.
- Wax paper can be used for cooking and reheating.
- Plastic wrap that is specially marked for microwave use can be used for cooking and reheating. DO NOT allow plastic wrap to touch food. Vent so steam can escape.
- Lids that are microwave-safe are a good choice because heat is kept near the food to hasten cooking.
- Oven cooking bags are good for large meats or foods that need tenderizing. DO NOT use metal twist ties. Remember to slit bag so steam can escape.

How to use aluminum foil in your microwave oven:

- Small flat pieces of aluminum foil placed smoothly on the food can be used to shield areas that are either defrosting or cooking too quickly.
- Foil should not come closer than one inch to any surface of the oven.

Should you have questions about utensils or coverings, check a good microwave cookbook or follow recipe suggestions.

ACCESSORIES There are many microwave accessories available for purchase. Evaluate carefully before you purchase so that they meet your needs. A microwave-safe thermometer will assist you in determining correct doneness and assure you that foods have been cooked to safe temperatures. Sharp is not responsible for any damage to the oven when accessories are used.



INFORMATION YOU NEED TO KNOW

ABOUT MICROWAVE COOKING

- Arrange food carefully. Place thickest areas towards outside of dish.
- Watch cooking time. Cook for the shortest amount of time indicated and add more as needed. Food severely overcooked can smoke or ignite.
- Cover foods while cooking. Check recipe or cookbook for suggestions: paper towels, wax paper, microwave plastic wrap or a lid. Covers prevent spattering and help foods to cook evenly.
- Shield with small flat pieces of aluminum foil any thin areas of meat or poultry to prevent overcooking before dense, thick areas are cooked thoroughly.
- Stir foods from outside to center of dish once or twice during cooking, if possible.
- Turn foods over once during microwaving to speed cooking of such foods as chicken and hamburgers. Large items like roasts must be turned over at least once.
- Rearrange foods such as meatballs halfway through cooking both from top to bottom and from the center of the dish to the outside.
- Add standing time. Remove food from oven and stir, if possible. Cover for standing time which allows the food to finish cooking without overcooking.
- Check for doneness. Look for signs indicating that cooking temperatures have been reached.
 - Doneness signs include:**
 - Food steams throughout, not just at edge.
 - Center bottom of dish is very hot to the touch.
 - Poultry thigh joints move easily.
 - Meat and poultry show no pinkness.
 - Fish is opaque and flakes easily with a fork.

ABOUT SAFETY

- Check foods to see that they are cooked to the United States Department of Agriculture's recommended temperatures.
- ALWAYS use potholders to prevent burns when handling utensils that are in contact with hot food. Enough heat from the food can transfer through utensils to cause skin burns.
- Avoid steam burns by directing steam away from the face and hands. Slowly lift the farthest edge of a dish's covering and carefully open popcorn and oven cooking bags away from the face.
- Stay near the oven while it's in use and check cooking progress frequently so that there is no chance of overcooking food.
- NEVER use the cavity for storing cookbooks or other items.
- Select, store and handle food carefully to preserve its high quality and minimize the spread of foodborne bacteria.
- Keep waveguide cover clean. Food residue can cause arcing and/or fires.
- Use care when removing items from the oven so that the utensil, your clothes or accessories do not touch the safety door latches.

TEMP	FOOD
160°F	... for fresh pork, ground meat, boneless white poultry, fish, seafood, egg dishes and frozen prepared food.
165°F	... for leftover, ready-to-reheat refrigerated, and deli and carry-out "fresh" food.
170°F	... white meat of poultry.
180°F	... dark meat of poultry.

To test for doneness, insert a meat thermometer in a thick or dense area away from fat or bone. NEVER leave the thermometer in the food during cooking, unless it is approved for microwave oven use.

PART NAMES

FRONT VIEW

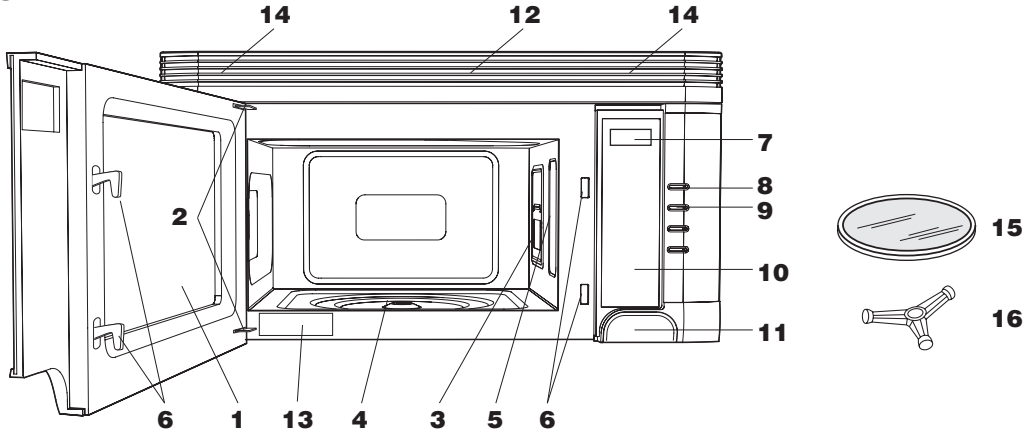

BOTTOM VIEW

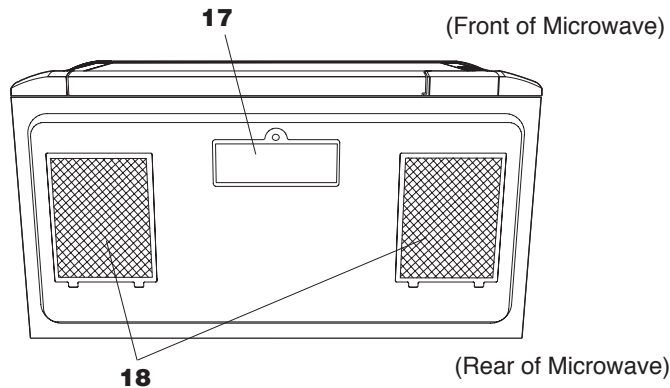

- 1** Oven door with see-through window
Be careful with the edge of the oven door as it is glass and could chip or break.
- 2** Door hinges
- 3** Waveguide cover:
DO NOT REMOVE.
- 4** Turntable motor shaft
- 5** Oven light
It will light when oven is operating or door is open.
- 6** Safety door latches
The oven will not operate unless the door is securely closed.
- 7** Time display: Digital display, 99 minutes, 99 seconds
- 8** LIGHT HI/LO pad
Press the LIGHT HI/LO pad one time for hi, twice for lo and three times to turn it off.
- 9** FAN HI/LO pad
Press the FAN HI/LO pad to turn on the fan. Press again for low speed. Press a third time to turn the fan off.

- 10** Auto-Touch control panel
- 11** One touch DOOR OPEN button
Push to open door.
- 12** Louver
- 13** Nameplate
- 14** Louver screws
Remove screws to replace charcoal filter.
- 15** Removable turntable
The turntable will rotate clockwise or counterclockwise. Only remove for cleaning.
- 16** Removable turntable support
First, carefully place the turntable support in the motor shaft in the center of the oven floor. Then, place the turntable on the turntable support securely.
- 17** Light cover
- 18** Grease filters



PART NAMES

CONTROL PANEL

Words in the lower portion of the display will light to indicate what function is in progress.

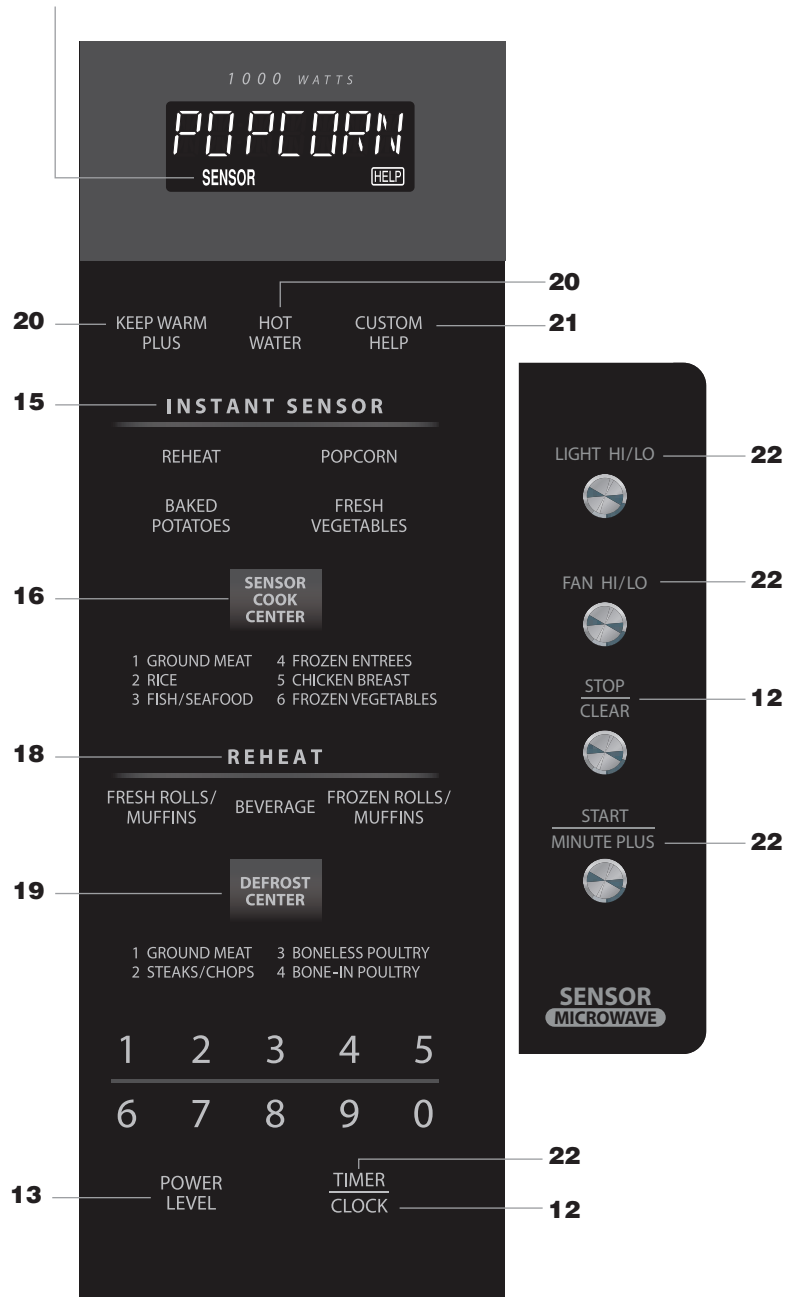

Number next to the control panel illustration indicates pages on which there are feature descriptions and usage information.





BEFORE OPERATING

- Before operating your new microwave oven make sure you read and understand this operation manual completely.
- Before the oven can be used, follow these procedures:

1. Plug in the oven. Close the door. The oven display will show WELCOME PRESS CLEAR AND PRESS CLOCK.
2. Touch the **STOP/CLEAR** pad. : will appear.
3. Set clock.

TO SET THE CLOCK

- Suppose you want to enter the correct time of day 12:30 (A.M. or P.M.).

PROCEDURE	DISPLAY
1 TIMER CLOCK 2 Touch CLOCK pad and number 2.	ENTER TIME
2 1 2 3 0 Enter the correct time of day by touching the numbers in sequence.	12:30
3 TIMER CLOCK Touch TIMER/CLOCK pad again.	12:30

This is a 12 hour clock. If you attempt to enter an incorrect clock time, ERROR will appear in the display. Touch the **STOP/CLEAR** pad and re-enter the time.

- If the electrical power supply to your microwave oven should be interrupted, the display will intermittently show WELCOME PRESS CLEAR AND PRESS CLOCK after the power is reinstated. If this occurs during cooking, the program will be erased. The time of day will also be erased. Simply touch **STOP/CLEAR** pad and reset the clock for the correct time of day.

STOP/CLEAR

Touch the **STOP/CLEAR** pad to:

1. Erase if you make a mistake during programming.
2. Cancel timer.
3. Stop the oven temporarily during cooking.
4. Return the time of day to the display.
5. Cancel a program during cooking, touch twice.

MANUAL OPERATION

TIME COOKING

Your oven can be programmed for 99 minutes 99 seconds (99.99). Always enter the seconds after the minutes, even if they are both zeros.

- Suppose you want to cook for 5 minutes at 100%.

PROCEDURE	DISPLAY
1 <input type="text" value="5"/> <input type="text" value="0"/> <input type="text" value="0"/> Enter cooking time.	<input type="text" value="5:00"/>
2 <input type="text" value="START"/> <input type="text" value="MINUTE PLUS"/> Touch START/ MINUTE PLUS pad.	<input type="text" value="5:00"/> <small>COOK</small>

TO SET POWER LEVEL

There are eleven preset power levels.

Using lower power levels increases the cooking time which is recommended for foods such as cheese, milk and long slow cooking of meats. Consult cookbook or recipes for specific recommendations.

TOUCH POWER LEVEL PAD NUMBER OF TIMES FOR DESIRED POWER	APPROXIMATE PERCENTAGE OF POWER	COMMON WORDS FOR POWER LEVELS
POWER LEVEL x 1	100%	High
POWER LEVEL x 2	90%	
POWER LEVEL x 3	80%	
POWER LEVEL x 4	70%	Medium High
POWER LEVEL x 5	60%	
POWER LEVEL x 6	50%	Medium
POWER LEVEL x 7	40%	
POWER LEVEL x 8	30%	Med Low/Defrost
POWER LEVEL x 9	20%	
POWER LEVEL x 10	10%	Low
POWER LEVEL x 11	0%	

- Suppose you want to defrost for 5 minutes at 30%.

PROCEDURE	DISPLAY
1 <input type="text" value="5"/> <input type="text" value="0"/> <input type="text" value="0"/> Enter defrost time.	<input type="text" value="5:00"/>
2 <input type="text" value="POWER LEVEL"/> x 8 Touch POWER LEVEL pad eight times or hold down until the desired power level appears.	<input type="text" value="P-30"/>
3 <input type="text" value="START"/> <input type="text" value="MINUTE PLUS"/> Touch START/ MINUTE PLUS pad.	<input type="text" value="5:00"/> <small>COOK</small>
4 When the defrost time is complete, a long tone will sound and <input type="text" value="END"/> will appear in the display.	

MANUAL DEFROST

If the food that you wish to defrost is not listed on the DEFROST CENTER CHART or is above or below the limits in the "Amount" column on the DEFROST CENTER CHART (see page 19), you need to defrost manually.

You can defrost any frozen food, either raw or previously cooked, by using Power Level for 30%. Follow the exact 4-step procedure found under To Set Power Level. Estimate defrosting time and press **POWER LEVEL** pad eight times for 30% power.

For either raw or previously cooked frozen food the rule of thumb is approximately 4 minutes per pound. For example, defrost 4 minutes for 1 pound of frozen spaghetti sauce.

Always stop the oven periodically to remove or separate the portions that are defrosted. If food is not defrosted at the end of the estimated defrosting time, program the oven in 1 minute increments on Power Level 30% until totally defrosted.

When using plastic containers from the freezer, defrost only long enough to remove from the plastic in order to place in a microwave-safe dish.



SPECIAL FEATURES

SENSOR COOK

Sharp's Sensor is a semi-conductor device that detects the vapor (moisture and humidity) emitted from the food as it heats. The sensor adjusts the cooking times and power level for various foods and quantities.

Using Sensor Settings:

1. After oven is plugged in, wait 2 minutes before using Sensor Cook.
2. Be sure the exterior of the cooking container and the interior of the oven are dry. Wipe off any moisture with a dry cloth or paper towel.
3. The oven works with foods at normal storage temperature. For example, popcorn would be at room temperature.
4. Any Sensor Cook selection can be programmed with More or Less Time Adjustment. See page 22.
5. More or less food than the quantity listed in the chart should be cooked following the guidelines in any microwave cookbook.
6. During the first part of Sensor Cook, food name will appear on the display. Do not open the oven door or touch **STOP/CLEAR** during this part of the cooking cycle. The measurement of vapor will be interrupted. If this occurs, an error message will appear. To continue cooking, touch the **STOP/CLEAR** pad and cook manually.

When the sensor detects the vapor emitted from the food, remainder of cooking time will appear. Door may be opened when remaining cooking time appears on the display. At this time, you may stir or season food, as desired.

7. If the sensor does not detect vapor properly when popping popcorn, the oven will turn off, and the correct time of day will be displayed. If the sensor does not detect vapor properly when cooking other foods, **ERROR** will be displayed, and the oven will turn off.
8. Check food for temperature after cooking. If additional time is needed, continue to cook manually.
9. Each food has a cooking hint. Touch **CUSTOM HELP** pad when the HELP indicator is lighted in the display.

Covering Foods:

Some foods work best when covered. Use the cover recommended in the Instant Sensor and Sensor Cook Center for these foods.

1. Casserole lid.
2. Plastic wrap: Use plastic wrap recommended for microwave cooking. Cover dish loosely; allow approximately 1/2 inch to remain uncovered to allow steam to escape. Plastic wrap should not touch food.
3. Wax paper: Cover dish completely; fold excess wrap under dish to secure. If dish is wider than paper, overlap two pieces at least one inch to cover.

Be careful when removing any covering to allow steam to escape away from you.



SPECIAL FEATURES

INSTANT SENSOR

Instant Sensor allows you to cook or reheat many of your favorite foods by touching just one pad.

- Suppose you want to cook 2 baked potatoes.

PROCEDURE	
1 Touch BAKED POTATOES pad.	BAKED POTATOES
2 Touch START/MINUTE PLUS pad.	START MINUTE PLUS

NOTE:

1. Instant Sensor can be programmed with More or Less Time Adjustment. See page 22.
2. The final result will vary according to the food condition (e.g. initial temperature, shape, quality). Check food for temperature after heating. If additional time is needed, continue to heat manually.

INSTANT SENSOR CHART

FOOD	AMOUNT	PROCEDURE
REHEAT	4 - 36 oz	Place in dish or casserole slightly larger than amount to be reheated. Flatten, if possible. Cover with lid, plastic wrap or wax paper. Use covers such as plastic wrap or lids with larger quantities of more dense foods such as stews. After reheating, stir well, if possible. Re-cover and allow to stand 2 to 3 minutes. Foods should be very hot. If not, continue to heat with variable power and time.
POPCORN	2.85 - 3.5 oz bag (Regular) 1.5 - 1.75 oz bag (Snack)	Use only popcorn packaged for the microwave. Try several brands to decide which you like. Do not try to pop unpopped kernels. Touch POPCORN pad once for regular size, touch again for snack size.
BAKED POTATOES	1 - 6 med.	Pierce. Place on paper-towel-lined turntable. After cooking, remove from oven, wrap in aluminum foil and let stand 5 to 10 minutes.
FRESH VEGETABLES: Soft		Wash and place in casserole. Add no water if vegetables have just been washed. Cover with lid for tender vegetables. Use plastic wrap for tender-crisp vegetables. Touch FRESH VEGETABLES pad once. After cooking, stir, if possible. Let stand, covered, for 2 to 5 minutes.
Broccoli	.25 - 2.0 lb	
Brussels sprouts	.25 - 2.0 lb	
Cabbage	.25 - 2.0 lb	
Caulif. (flowerets)	.25 - 2.0 lb	
Cauliflower (whole)	1 med.	
Spinach	.25 - 1.0 lb	
Zucchini	.25 - 2.0 lb	
Baked apples	2 - 4 med.	
FRESH VEGETABLES: Hard		Place in casserole. Add 1-4 tbsp water. Cover with lid for tender vegetables. Use plastic wrap cover for tender-crisp vegetables. Touch FRESH VEGETABLES pad twice. After cooking, stir, if possible. Let stand, covered, for 2 to 5 minutes.
Carrots, sliced	.25 - 1.5 lb	
Corn on the cob	2 - 4	
Green beans	.25 - 1.5 lb	
Winter squash:		
diced	.25 - 1.5 lb	
halves	1 - 2	





SPECIAL FEATURES

SENSOR COOK CENTER

You can cook many foods by touching the Sensor Cook Center pad and the food number. You don't need to calculate cooking time or power level.

- Suppose you want to cook ground meat.

PROCEDURE

1 Touch **SENSOR COOK CENTER** pad and number **1**.



2 Touch **START/MINUTE PLUS** pad.



When the sensor detects the vapor emitted from the food, remainder of cooking time will appear.

NOTE:

1. Sensor Cook Center can be programmed with More or Less Time Adjustment. See page 22.
2. The final result will vary according to the food condition (e.g. initial temperature, shape, quality). Check food for temperature after heating. If additional time is needed, continue to heat manually.

SENSOR COOK CENTER Chart

FOOD	AMOUNT	PROCEDURE															
1. GROUND MEAT	.25 - 2.0 lb	Use this setting to cook ground beef or turkey as patties or in a casserole to be added to other ingredients. Place patties on a microwave-safe rack and cover with wax paper. Place ground meat in a casserole and cover with wax paper or plastic wrap. When oven stops, turn patties over or stir meat in casserole to break up large pieces. Re-cover and touch START/MINUTE PLUS . After cooking, let stand, covered, for 2 to 3 minutes.															
2. RICE	.5 - 2.0 cups	Place rice into a deep casserole dish and add double quantity of water. Cover with lid or plastic wrap. After cooking, stir, cover and let stand 3 to 5 minutes or until all liquid has been absorbed. <table border="1" data-bbox="546 1212 1283 1377"> <thead> <tr> <th>Rice</th> <th>Water</th> <th>Size of casserole dish</th> </tr> </thead> <tbody> <tr> <td>.5 cup</td> <td>1 cup</td> <td>1.5 quart</td> </tr> <tr> <td>1 cup</td> <td>2 cups</td> <td>2 quart</td> </tr> <tr> <td>1.5 cups</td> <td>3 cups</td> <td>2.5 or 3 quart</td> </tr> <tr> <td>2 cups</td> <td>4 cups</td> <td>3 quart or larger</td> </tr> </tbody> </table>	Rice	Water	Size of casserole dish	.5 cup	1 cup	1.5 quart	1 cup	2 cups	2 quart	1.5 cups	3 cups	2.5 or 3 quart	2 cups	4 cups	3 quart or larger
Rice	Water	Size of casserole dish															
.5 cup	1 cup	1.5 quart															
1 cup	2 cups	2 quart															
1.5 cups	3 cups	2.5 or 3 quart															
2 cups	4 cups	3 quart or larger															
3. FISH/ SEAFOOD	.25 - 2.0 lb	Arrange in ring around shallow glass dish (roll fillet with edges underneath). Cover with plastic wrap. After cooking, let stand, covered, 3 minutes.															
4. FROZEN ENTREES	6 - 17 oz	Use this pad for frozen, convenience foods. It will give satisfactory results for most brands. You may wish to try several and choose your favorite. Remove package from outer wrapping and follow package directions for covering. After cooking, let stand, covered for 1 to 3 minutes.															
5. CHICKEN BREAST	.5 - 2.0 lb	Cover with vented plastic wrap. When oven stops, turn over. Shield with small, flat pieces of aluminum foil any areas that are cooking too rapidly. Re-cover and touch START/MINUTE PLUS . After cooking, let stand, covered 3 to 5 minutes. Chicken should be 160°F.															
6. FROZEN VEGETABLES	.25 - 1.25 lb	Do not add water. Cover with lid or plastic wrap. After cooking, stir and let stand, covered, for 3 minutes.															





SPECIAL FEATURES

SENSOR COOK RECIPES

Glazed Apple Slices

Makes 6 to 8 servings

- | | |
|-----------------------------------|--|
| 1/4 cup brown sugar | 3/4 cup orange juice |
| 3 tablespoons margarine or butter | 1 tablespoon cornstarch |
| 2 tablespoons apricot preserves | 4 baking apples (about 1 1/2 pounds), peeled and sliced into 8 pieces each |
| 1/2 teaspoon ground nutmeg | 3 tablespoons chopped green pistachios |
| 1/4 teaspoon salt | |
| 1/2 cup sugar | |

- 1 Combine brown sugar, margarine and apricot preserves in a small bowl. Microwave at HIGH (100%) until margarine melts and preserves soften, 45 seconds to 1 minute. Stir in nutmeg, salt, sugar, orange juice and cornstarch. Microwave at HIGH (100%) until thickened, 4 to 6 minutes, stirring several times.
- 2 Arrange apple slices in a large microwave serving dish. Spread hot sauce over apples. Cover well with vented plastic wrap. Microwave using **INSTANT SENSOR - FRESH VEGETABLES**: Soft. Allow to cool 5 minutes before serving.
- 3 Sprinkle with pistachios. Serve alone or over vanilla ice cream or sponge cake.

Confetti Soup

Makes 6 servings

- | | |
|--|------------------------------------|
| 3 tablespoons butter or margarine | 1 teaspoon salt |
| 1 cup cubed carrots, 1/4-inch cubes | 1/2 teaspoon pepper |
| 1 cup rutabaga, 1/4-inch cubes | 1/4 teaspoon sugar |
| 1 small zucchini, 1/4-inch cubes | 4 cups milk |
| 1/2 cup chopped onion | 1 cup shredded Cheddar cheese |
| 1/2 cup chopped celery | 1 cup frozen corn, thawed |
| 1 cup fresh broccoli flowerets or cauliflowerets | 1/2 cup cooked ham, 1/4-inch cubes |
| 1/4 cup all-purpose flour | 1/2 cup frozen peas, thawed |

- 1 Combine butter, carrots, rutabaga, zucchini, onion, celery and broccoli in 3-quart, covered casserole.
- 2 Microwave using **INSTANT SENSOR - FRESH VEGETABLES**: Soft. Stir well.
- 3 Stir in flour, salt, pepper, sugar, milk, cheese, corn, ham and peas.
- 4 Microwave using **INSTANT SENSOR - REHEAT**. Stir well and serve with croutons.

Mixed Company Vegetables

Makes 8 servings

- | | |
|---|---|
| 3 green onions, diagonally cut into 1-inch pieces | 3/4 pound carrots, cut into 1/4-inch thick slices |
| 1 teaspoon minced garlic | 1 bunch of broccoli, cut into 2-inch by 1-inch pieces |
| 1/4 teaspoon crushed red pepper | 1 medium red pepper, sliced into matchstick-thin strips |
| 2 tablespoons olive oil | 1/2 pound medium mushrooms, sliced |
| 2 tablespoons teriyaki sauce | |

- 1 In a small, microwave-safe bowl, combine green onions, garlic, crushed red pepper and oil. Microwave on HIGH (100%) for 2 minutes. Stir in teriyaki sauce.
- 2 In a 3-quart casserole, place carrots, broccoli, red peppers and mushrooms. Cover with plastic wrap.
- 3 Microwave using **INSTANT SENSOR - FRESH VEGETABLES**: Soft for tender crisp or **INSTANT SENSOR - FRESH VEGETABLES**: Hard for softer vegetables.
- 4 Remove from oven and drain. Add green onion mixture and stir to combine. Serve immediately.





SPECIAL FEATURES

REHEAT

Reheat allows you to heat three of your favorite foods by touching just one pad.

- Suppose you want to heat 2 fresh rolls or muffins.

PROCEDURE	DISPLAY
<p>1 FRESH ROLLS/ MUFFINS</p> <p>Select desired setting. Touch FRESH ROLLS MUFFINS pad 2 times.</p>	
<p>2 START MINUTE PLUS</p>	<p>Touch START/ MINUTE PLUS pad.</p>

NOTE:

1. To increase quantity, touch chosen pad until number in display is same as desired quantity to cook. Ex: touch **BEVERAGE** three times for 1.5 cups. More or less food than the quantity listed in the chart should be heated following the guidelines in any microwave cookbook.
2. Reheat can be programmed with More or Less Time Adjustment. See page 22.
3. The final result will vary according to the food condition (e.g. initial temperature, shape, quality). Check food for temperature after heating. If additional time is needed, continue to heat manually.

REHEAT CHART

FOOD	AMOUNT	PROCEDURE								
FRESH ROLLS/ MUFFINS	1 - 8	Use this pad to warm rolls, muffins, biscuits, bagels etc. Large items should be considered as 2 or 3 regular size. Arrange on plate; cover with paper towel. For refrigerated rolls or muffins, it may be necessary to double the entered amount to ensure the proper serving temperature. For example, enter quantity of 2 for 1 refrigerated muffin.								
BEVERAGE	.5 - 2.0 cups	<p>This setting is good for restoring cooled beverage to a better drinking temperature. Stir liquid briskly before and after heating to avoid "eruption". Touch BEVERAGE pad.</p> <p style="text-align: center;">Press the pad for amount (cups).</p> <table border="1" style="margin-left: auto; margin-right: auto;"> <tr><td>Once</td><td>.5</td></tr> <tr><td>Twice</td><td>1.0</td></tr> <tr><td>3 times</td><td>1.5</td></tr> <tr><td>4 times</td><td>2.0</td></tr> </table>	Once	.5	Twice	1.0	3 times	1.5	4 times	2.0
Once	.5									
Twice	1.0									
3 times	1.5									
4 times	2.0									
FROZEN ROLLS/ MUFFINS	1 - 8	Use this pad to warm rolls, muffins, biscuits, bagels etc. Large items should be considered as 2 or 3 regular size. Arrange on plate; cover with paper towel.								



SPECIAL FEATURES

DEFROST CENTER

DEFROST CENTER automatically defrosts all the foods shown in the DEFROST CENTER CHART below.

Round the weight to the nearest half pound. (Ex: if the steak's actual weight is 2.2 lb round to 2.0 lb. If the steak's weight is 2.4 lb round to 2.5 lb).

Touch **DEFROST CENTER** pad and the desired number for food selection. Then enter weight in .1 lb.

- Suppose you want to defrost a 3.0 pound steak.

PROCEDURE	DISPLAY
<p>1 Touch DEFROST CENTER pad and press number 2 for STEAKS/CHOPS. Enter weight 3.0 lb. Touch START/MINUTE PLUS pad.</p> <p>The oven will stop and directions will be displayed.</p>	
<p>2 After the 1st stage, open the door, turn steak over and shield any warm portions. Close the door.</p> <p>Touch START/MINUTE PLUS pad.</p>	

- 3** After the 2nd stage, open the door and shield any warm portions. Close the door.

START
MINUTE PLUS

Touch **START/MINUTE PLUS** pad.

- 4** After defrost cycle ends, cover and let stand as indicated in chart below.

NOTE:

1. Any Defrost Center choice can be programmed with More or Less Time Adjustment. Touch the **POWER LEVEL** pad once or twice after selecting the amount. See page 22.
2. To defrost other foods or foods above or below the weights allowed on the DEFROST CENTER CHART, use time and 30% power. See MANUAL DEFROST on page 13.

If you attempt to enter more or less than the allowed amount as indicated in the chart below, **ERROR** will appear in the display.

DEFROST CENTER CHART

FOOD	AMOUNT	PROCEDURE
GROUND MEAT	.5 - 2.0 lb	Pull apart and remove any thawed pieces after each stage. Let stand, covered, for 5 to 10 minutes.
STEAKS/CHOPS	.5 - 3.0 lb	After each stage, rearrange and if there are warm or thawed portions, shield with small flat pieces of aluminum foil. Remove any meat or fish that is nearly defrosted. Let stand, covered, for 10 to 20 minutes.
POULTRY BONELESS	.5 - 2.0 lb	Use boneless breast of chicken or turkey. After each stage, if there are warm or thawed portions, rearrange or remove. Let stand, covered, for 10 to 20 minutes.
POULTRY BONE-IN	.5 - 3.0 lb	Arrange pieces with meatiest portions toward outside of glass dish or microwave safe rack. After each stage, if there are warm or thawed portions, rearrange or remove. Let stand, covered, for 10 to 20 minutes.

NOTE:

Check foods when oven signals. After final stage, small sections may still be icy. Let stand to continue thawing. Do not defrost until all ice crystals are thawed.

Shielding prevents cooking from occurring before the center of the food is defrosted. Use small smooth strips of aluminum foil to cover edges and thinner sections of the food.





SPECIAL FEATURES

KEEP WARM PLUS

KEEP WARM PLUS allows you to keep food warm for 30 minutes.

DIRECT USE

- Suppose you want to keep a cup of soup warm for 30 minutes.

PROCEDURE	
1 Touch KEEP WARM PLUS pad.	KEEP WARM PLUS
2 Enter the desired time.	3 0 0 0
3 Touch START/ MINUTE PLUS pad.	START MINUTE PLUS
The oven will start. The display will show 30:00 and count down. KEEP WARM will be displayed during the countdown.	

WITH MANUAL COOKING

- Suppose you want to cook a cup of soup for 2 minutes at 70% and keep the soup warm for 15 minutes.

PROCEDURE	
1 Enter the desired time.	2 0 0
2 Touch POWER LEVEL pad 4 times for 70% power.	POWER LEVEL x 4
3 Touch KEEP WARM PLUS pad.	KEEP WARM PLUS
4 Enter the desired time.	1 5 0 0
5 Touch START/ MINUTE PLUS pad.	START MINUTE PLUS
The operation will start. When the cooking time is complete, a long tone will sound and Keep Warm Plus will start. KEEP WARM will appear in the display every 10 seconds and count down for 15 minutes.	

NOTE:

Keep Warm Plus cannot be programmed with SPECIAL FEATURES.

HOT WATER

HOT WATER heats 1 to 6 cups of tap water to prepare coffee, tea, bouillon and instant soup as well as heat the water to cook pasta. When preparing individual cups, place instant coffee, tea or bouillon in cup and stir before heating. Allow to stand 20 seconds after heating before stirring and drinking. Stir carefully after removing from the oven. When heating 4 to 6 cups of water, place in large casserole and cover with lid or plastic wrap. When oven signals, add pasta and continue cooking according to package directions. Touch **HOT WATER** pad once for each cup up to 6.

- Suppose you want to heat 3 cups of water.

PROCEDURE	
1 Touch HOT WATER pad 3 times.	HOT WATER x 3
2 Touch START/ MINUTE PLUS pad.	START MINUTE PLUS

OTHER CONVENIENT FEATURES

CUSTOM HELP

Custom Help provides 4 features that make using your oven easy because specific instructions are provided in the interactive display.

1. CHILD LOCK

The Child Lock prevents unwanted oven operation such as by small children. The oven can be set so that the control panel is deactivated or locked. To set, touch **CUSTOM HELP**, the number **1** and then touch the **START/MINUTE PLUS** pad. Should a pad be touched, **CHILD LOCK ON** will appear in the display.

To cancel, touch **CUSTOM HELP** and **STOP/CLEAR** pad.

2. AUDIBLE SIGNAL ELIMINATION

If you wish to have the oven operate with no audible signals, touch **CUSTOM HELP**, the number **2** and touch **STOP/CLEAR**.

To cancel and restore the audible signal, touch **CUSTOM HELP**, the number **2** and touch **START/MINUTE PLUS**.

3. AUTO START

If you wish to program your oven to begin cooking automatically at a designated time of day, follow this procedure:

- Suppose you want to start cooking a stew for 20 minutes on 50% at 4:30. Before setting, check to make sure the clock is showing the correct time of day.

PROCEDURE	
1 Touch CUSTOM HELP pad.	CUSTOM HELP
2 Touch number 3 .	3
3 Enter the start time.	4 3 0
4 Touch TIMER/CLOCK pad.	TIMER CLOCK
5 Enter cooking program.	2 0 0 0 POWER LEVEL x 6
6 Touch START/MINUTE PLUS pad.	START MINUTE PLUS

NOTE:

1. Auto Start can be used for manual cooking if clock is set.

2. If the oven door is opened after programming Auto Start, it is necessary to touch the **START/MINUTE PLUS** pad for Auto Start time to appear in the readout so that the oven will automatically begin programmed cooking at the chosen Auto Start time.

3. Be sure to choose foods that can be left in the oven safely until the Auto Start time. Acorn or butternut squash are often a good choice.

4. LANGUAGE / WEIGHT SELECTION

The oven comes set for English and U.S. Customary Unit-pounds. To change, touch **CUSTOM HELP** and the number **4**. Continue to touch the number **4** until your choice is selected from the table below. Then, touch **START/MINUTE PLUS**.

Touch number **4** for language and standard of weight.

NUMBER	LANGUAGE	STANDARD OF WEIGHT	DISPLAY
Once	English	LBS	ENGLISH Lb
Twice	English	KG	ENGLISH KG
3 times	Spanish	LBS	ESPANOL Lb
4 times	Spanish	KG	ESPANOL KG
5 times	French	LBS	FRANC. Lb
6 times	French	KG	FRANC. KG

HELP

Each setting of Instant Sensor, Sensor Cook Center, Reheat, Hot Water, Keep Warm Plus and Defrost Center has a cooking hint. If you wish to check, touch **CUSTOM HELP** whenever HELP is lighted in the Interactive Display for these and other manual operation hints.

DEMONSTRATION MODE

To demonstrate, touch **TIMER/CLOCK**, the number **0** and then touch the **START/MINUTE PLUS** pad and hold for three seconds. **DEMO ON** will appear in the display. Cooking operations and specific special features can now be demonstrated with no power in the oven. For example, touch **MINUTE PLUS** pad and the display will show **1:00** and count down quickly to **END**.

To cancel, touch **TIMER/CLOCK**, the number **0** and **STOP/CLEAR** pads. If easier, unplug the oven from the electrical outlet and replug.



OTHER CONVENIENT FEATURES

MULTIPLE SEQUENCE COOKING

Your oven can be programmed for up to 4 automatic cooking sequences, switching from one power level setting to another automatically.

Sometimes cooking directions tell you to start on one power level and then change to a different power level. Your oven can do this automatically.

- Suppose you want to cook roast beef for 5 minutes at 100% and then continue to cook for 30 minutes at 50%.

PROCEDURE	
1 First enter cooking time. Then touch POWER LEVEL once for 100% power.	<div style="display: flex; align-items: center;"> <div style="border: 1px solid black; padding: 2px 5px; margin-right: 5px;">5</div> <div style="border: 1px solid black; padding: 2px 5px; margin-right: 5px;">0</div> <div style="border: 1px solid black; padding: 2px 5px; margin-right: 5px;">0</div> <div style="border: 1px solid black; padding: 2px 5px; margin-right: 5px;">0</div> </div> <div style="display: flex; align-items: center; margin-top: 5px;"> <div style="border: 1px solid black; padding: 2px 5px; margin-right: 5px;">POWER LEVEL</div> x 1 </div>
2 Then enter second cooking time. Touch POWER LEVEL pad 6 times for 50% power.	<div style="display: flex; align-items: center;"> <div style="border: 1px solid black; padding: 2px 5px; margin-right: 5px;">3</div> <div style="border: 1px solid black; padding: 2px 5px; margin-right: 5px;">0</div> <div style="border: 1px solid black; padding: 2px 5px; margin-right: 5px;">0</div> <div style="border: 1px solid black; padding: 2px 5px; margin-right: 5px;">0</div> <div style="border: 1px solid black; padding: 2px 5px; margin-right: 5px;">0</div> </div> <div style="display: flex; align-items: center; margin-top: 5px;"> <div style="border: 1px solid black; padding: 2px 5px; margin-right: 5px;">POWER LEVEL</div> x 6 </div>
3 Touch START/MINUTE PLUS pad.	<div style="border: 1px solid black; padding: 5px; text-align: center; width: fit-content; margin: 0 auto;"> START MINUTE PLUS </div>

NOTE:

1. If **POWER LEVEL** pad is touched, HIGH will be displayed.
2. If 100% is selected as the final sequence, it is not necessary to touch the **POWER LEVEL** pad.
3. Keep Warm can be programmed even if 4 cooking sequences have been set.

TIMER

- Suppose you want to time a 3-minute long distance phone call.

PROCEDURE	
1 Touch TIMER/CLOCK and number 1 pad.	<div style="display: flex; align-items: center;"> <div style="border: 1px solid black; padding: 2px 5px; margin-right: 5px;">TIMER CLOCK</div> <div style="border: 1px solid black; padding: 2px 5px; margin-left: 5px;">1</div> </div>
2 Enter the time.	<div style="display: flex; align-items: center;"> <div style="border: 1px solid black; padding: 2px 5px; margin-right: 5px;">3</div> <div style="border: 1px solid black; padding: 2px 5px; margin-right: 5px;">0</div> <div style="border: 1px solid black; padding: 2px 5px; margin-right: 5px;">0</div> <div style="border: 1px solid black; padding: 2px 5px; margin-right: 5px;">0</div> </div>
3 Touch TIMER/CLOCK pad.	<div style="border: 1px solid black; padding: 5px; text-align: center; width: fit-content; margin: 0 auto;"> TIMER CLOCK </div>
To cancel the timer, touch the STOP/CLEAR pad once.	<div style="border: 1px solid black; padding: 5px; text-align: center; width: fit-content; margin: 0 auto;"> STOP CLEAR </div>

MORE OR LESS TIME ADJUSTMENT

Should you discover that you like any of the Instant Sensor, Sensor Cook Center, Defrost Center, Reheat or Hot Water settings slightly **more** done, touch the **POWER LEVEL** pad **once** after touching your choice of pads or before touching **START/MINUTE PLUS** pad. The display will show MORE.

Should you discover that you like any of the Instant Sensor, Sensor Cook Center, Defrost Center, Reheat or Hot Water settings slightly **less** done, touch the **POWER LEVEL** pad **twice** after touching your choice of pads or before touching **START/MINUTE PLUS** pad. The display will show LESS.

MINUTE PLUS

Minute Plus allows you to cook for a minute at 100% by simply touching the a **START/MINUTE PLUS** pad. You can also extend cooking time in multiples of 1 minute by repeatedly touching the **START/MINUTE PLUS** pad during manual cooking.

- Suppose you want to heat a cup of soup for one minute.

PROCEDURE	
Touch START/MINUTE PLUS pad.	<div style="border: 1px solid black; padding: 5px; text-align: center; width: fit-content; margin: 0 auto;"> START MINUTE PLUS </div>

NOTE:

1. To use Minute Plus, touch pad within 3 minutes after cooking, closing the door, touching the **STOP/CLEAR** pad or during cooking.
2. Minute Plus cannot be used with special features.

LIGHT HI/LO

Press the **LIGHT HI/LO** pad one time for high, twice for low and three times to turn it off.

FAN HI/LO

The fan will automatically start when heat rises from range surface units or burners. This protects the microwave oven from excessive temperature rise. The fan will stay on until the temperature decreases. It cannot be turned off manually during this time.

For other uses, press **FAN HI/LO** pad to select fan speed or turn fan off. When fan is manually turned on, "H" will be shown on the display. When the fan is turned off, "H" will disappear from display.



CLEANING AND CARE

Disconnect the power cord before cleaning or leave the door open to inactivate the oven during cleaning.

EXTERIOR

The outside surface is precoated steel and plastic. Clean the outside with mild soap and water; rinse and dry with a soft cloth. Do not use any type of household or abrasive cleaner.

DOOR

Be careful with the edge of the oven door as it is glass and could chip or break. Wipe the window on both sides with a damp cloth to remove any spills or splatters. Metal parts will be easier to maintain if wiped frequently with a damp cloth. Avoid the use of spray and other harsh cleaners as they may stain, streak or dull the door surface.

Stainless Steel Trim (R-1514)

The exterior should be wiped often with a damp cloth and polished with a soft dry cloth to maintain its beauty. There are also a variety of products designed especially for cleaning and shining the stainless exterior of the oven. We recommend that the cleaner be applied to a soft cloth and then carefully used on the stainless exterior rather than sprayed directly onto it. Follow package directions carefully.

TOUCH CONTROL PANEL

Wipe the panel with a cloth dampened slightly with water only. Dry with a soft cloth. Do not scrub or use any sort of chemical cleaners. Close door and touch **STOP/CLEAR**.

INTERIOR

Cleaning is easy because little heat is generated to the interior surfaces; therefore, there is no baking and setting of spills or spattering. To clean the interior surfaces, wipe with a soft cloth and warm water. **DO NOT USE ABRASIVE OR HARSH CLEANERS OR SCOURING PADS.** For heavier soil, use baking soda or a mild soap; rinse thoroughly with hot water. The rack can be cleaned with hot soapy water, rinsed and dried.

ODOR REMOVAL

Occasionally, a cooking odor may remain in the oven. To remove, combine 1 cup water, grated peel and juice of 1 lemon and several whole cloves in a 2-cup glass measuring cup. Boil for several minutes using 100% power. Allow to set in oven until cool. Wipe interior with a soft cloth.

TURNTABLE/TURNTABLE SUPPORT

The turntable and turntable support can be removed for easy cleaning. Wash them in mild, sudsy water; for stubborn stains use a mild cleanser and non-abrasive scouring sponge. They are also dishwasher-proof. Use upper rack of dishwasher. The turntable motor shaft is not sealed, so excess water or spills should be wiped up immediately.

WAVEGUIDE COVER

The waveguide cover is located on the right side wall of the oven cavity. It is made from mica so requires special care. Keep the waveguide cover clean to assure good oven performance. Carefully wipe with a damp cloth any food splatters from the surface of the cover immediately after they occur. Built-up splashes may overheat and cause smoke or possibly catch fire. **DO NOT REMOVE THE WAVEGUIDE COVER.**

GREASE FILTERS

Filters should be cleaned at least once a month. Never operate the fan or oven without the filters in place.

1. Pull down slightly on the tab toward the front of the oven and remove the filter. Repeat for the other filter.
2. Soak the filters in a sink or dish pan filled with hot water and detergent. **DO NOT** use ammonia or other alkali; they will react with the filter material and darken it.
3. Agitate and scrub with a brush to remove embedded dirt.
4. Rinse thoroughly and shake dry.
5. Replace by fitting the filter back into the opening.

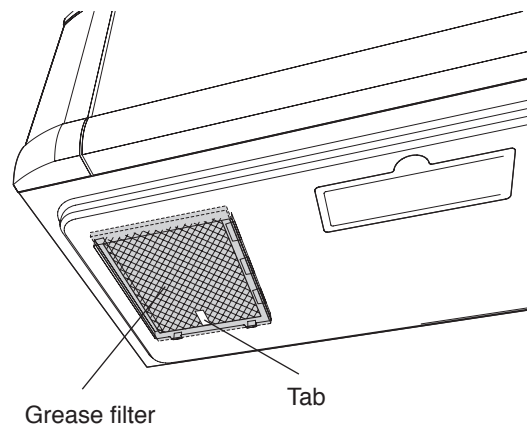



REPLACING PARTS

CHARCOAL FILTER

Charcoal Filter, Sharp part number RK-240 which was installed in your oven, is used for nonvented, recirculated installation. The filter should be changed every 6 to 12 months depending on use. See page 6 for ordering information.

1. Disconnect power to the oven at the circuit breaker panel or by unplugging.
2. Remove the three louver mounting screws and push down carefully on the tab at each end of the louver to disengage it. (See illustration.)
3. Pull the louver away from the unit.
4. Change the charcoal filter.
5. Carefully push the louver back into place (engaging both the bottom and top tabs) and replace the screws removed in step 2.

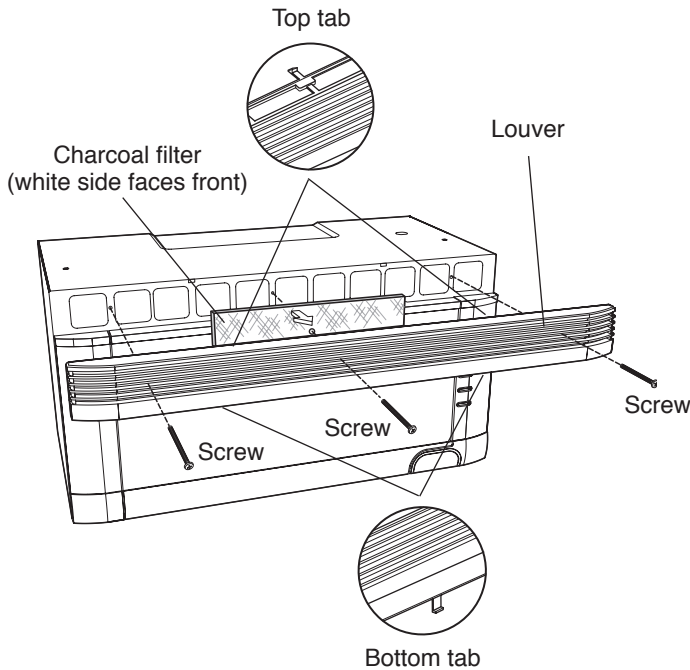

LIGHT BULBS

1. To replace light bulbs, first disconnect power to the oven at the circuit breaker panel or by unplugging.
2. To release cover, remove the screw on the light cover. (See illustration.)
3. Replace light bulbs with equivalent watt bulb available from your Sharp Authorized Servicer or parts distributor. Bulbs are also available at most hardware stores or lighting centers. **DO NOT USE A BULB LARGER THAN 30 WATTS.**
4. Close light cover and secure with screw removed in step 2.

CAUTION: Light cover may become very hot. Do not touch glass when light is on.

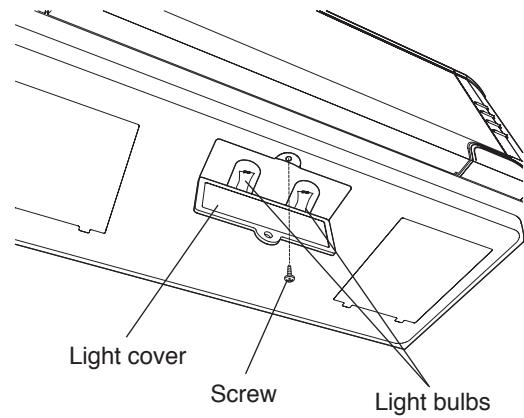



SERVICE CALL CHECK

Please check the following before calling for service:

Place one cup of water in a glass measuring cup in the oven and close the door securely.
Operate the oven for one minute at HIGH 100%.

- A** Does the oven light come on? YES _____ NO _____
- B** Does the cooling fan work?
(Put your hand over the left side of louver.) YES _____ NO _____
- C** Does the turntable rotate?
(It is normal for the turntable to turn in either direction.) YES _____ NO _____
- D** Is the water in the oven warm? YES _____ NO _____
- E** Does "H" appear on the display when fan is manually turned on? YES _____ NO _____

If "NO" is the answer to any of the above questions, please check electrical outlet, fuse and/or circuit breaker. If they are functioning properly, CONTACT YOUR NEAREST SHARP AUTHORIZED SERVICER. A microwave oven should never be serviced by a "do-it-yourself" repair person.

NOTE: If time appearing in the display is counting down very rapidly, check Demonstration Mode on page 21 and cancel.

SPECIFICATIONS

AC Line Voltage:	Single phase 120V, 60Hz, AC only
AC Power Required:	1600 watts, 14.0 amps.
Output Power:	1000 watts* (IEC Test Procedure)
Frequency:	2450 MHz
Outside Dimensions:	29 15/16"(W) x 16 1/4"(H) x 15 9/16"(D)
Cavity Dimensions:	17 1/2"(W) x 9 7/8"(H) x 14 15/16"(D)
Oven Capacity:**	1.5 Cu. Ft.
Cooking Uniformity:	Turntable system, diameter 14 1/8"
Weight:	Approx. 55 lb

★ The International Electrotechnical Commission's standardized method for measuring output wattage. This test method is widely recognized.

★★ Internal capacity is calculated by measuring maximum width, depth and height. Actual capacity for holding food is less.

In compliance with standards set by:

- FCC** – Federal Communications Commission Authorized.
- DHHS** – Complies with Department of Health and Human Services (DHHS) rule, CFR, Title 21, Chapter I, Subchapter J.



– This symbol on the nameplate means the product is listed by Underwriters Laboratories, Inc.





VEGETABLE COOKING CHART

VEGETABLE	AMOUNT	COOKING PROCEDURE	MICROWAVE TIME AT HIGH (100%)	STANDING TIME, COVERED
Artichokes Fresh	2 medium	Trim and rinse. 2-qt casserole. 2 tbsp water. Cover with plastic wrap.	5-8 min.	5 min.
Asparagus Fresh Spears	1 lb	2-qt casserole. 2 tbsp water. Cover. Rearrange after 3 min.	4-7 min.	2 min.
Beans Fresh, Green and Wax	1 lb	1 1/2-in pieces, 2-qt casserole. 1/4 cup water. Cover. Stir twice.	9-13 min.	2 min.
Beets Fresh, Whole	5 medium	Wash. Leave 1 inch of tops. 2-qt casserole. 1/4 cup water. Cover. Stir every 5 min.	12-18 min.	3 min.
Broccoli Fresh, Spears	1 lb	Wash. 2-qt casserole. Add no water. Cover. Rearrange after 3 min. Uncover during stand.	6-8 min.	3 min. uncovered
Fresh, Pieces	1 lb	Wash. 2-qt casserole. Add no water. Cover. Stir after 3 min. Uncover during stand.	5-7 min.	2 min. uncovered
Brussels Sprouts Fresh	4 cups	2-qt casserole. 1/4 cup water. Cover. Stir after 2 min.	6-8 min.	3 min.
Cabbage Shredded	1 lb	2-qt casserole. 2 tbsp water. Cover. Stir, after 4 min.	8-12 min.	2 min.
Wedges	1 lb	2-qt casserole. 2 tbsp water. Cover. Rearrange after 5 min.	12-14 min.	3 min.
Carrots Fresh, Slices	2 cups	1-qt casserole, 2 tbsp water. Cover. Stir after 3 min.	5-8 min.	3 min.
Cauliflower Fresh, Flowerets	2 cups	1-qt casserole. 1 tbsp water. Cover. Stir after 2 min.	3-5 min.	2 min.
Fresh, Whole	1 1/2 lb	Remove leaves and core center. 2-qt casserole. 2 tbsp water. Cover.	7-9 min.	3 min.
Corn Fresh, on Cob	2 ears	9-in pie plate. 2 tbsp water. Cover. Rearrange after 4 min.	6-9 min.	5 min.
	4 ears	2-qt oval or rectangular casserole. 1/4 cup water. Cover.	12-14 min.	5 min.
Frozen, on Cob	2 ears	9-in pie plate. 2 tbsp water. Cover. Rearrange after 4 min.	6-8 min.	5 min.
	4 ears	2-qt oval or rectangular casserole. 1/4 cup water. Cover.	10-12 min.	5 min.





VEGETABLE COOKING CHART (continued)

VEGETABLE	AMOUNT	COOKING PROCEDURE	MICROWAVE TIME AT HIGH (100%)	STANDING TIME, COVERED
Peas, Green Fresh	2 cups		4-6 min.	3 min.
Potatoes Boiled	4 medium		9-12 min.	3 min.
Spinach Fresh	1 lb		5-7 min.	2 min.
Squash Fresh, Acorn	1 whole		7-10 min.	5 min.
Fresh, Sliced Zucchini	2 cups		2-4 min.	1 min.
Sweet Potatoes Baked	2 medium 4 medium		5-9 min. 10-13 min.	5 min. 5 min.
Tomatoes Fresh	2 medium 4 medium		2-4 min. 5-8 min.	2 min. 2 min.
Canned Vegetables	15 to 16 oz		2-4 min.	2 min.





REHEATING CHART

ITEM	STARTING TEMPERATURE	MICROWAVE TIME	PROCEDURE
Plate of Food 1 serving of meat, 2 servings of vegetables	Room temp. Refrigerated	MED.-HIGH (70%) 1 1/2-2 3/4 min. 2 3/4-4 min.	Meaty portions and bulky vegetables to outside. Cover with wax paper.
Meat (Chicken pieces, chops, hamburgers, meat loaf slices) 1 serving 2 servings	Refrigerated Refrigerated	MED.-HIGH (70%) 1-2 min. 2-4 min.	Cover loosely with wax paper.
Meat Slices (Beef, ham, pork, turkey) 1 or more servings	Room temp. Refrigerated	MEDIUM (50%) 1-1 3/4 min. per serving 1 1/2-2 1/2 min. per serving	Cover with gravy or wax paper. Check after 30 sec. per serving.
Stirrable Casseroles and Main Dishes 1 serving 2 servings 4-6 servings	Refrigerated Refrigerated Refrigerated	HIGH (100%) 2 3/4-3 1/2 min. 5 - 6 3/4 min. 9 -10 min.	Cover with plastic wrap. Stir after half the time.
Nonstirrable Casseroles and Main Dishes 1 serving 2 servings 4-6 servings	Refrigerated Refrigerated Refrigerated	MEDIUM (50%) 4 1/2-7 1/2 min. 7 1/2-11 min. 12-15 min.	Cover with wax paper.
After reheating, food should be very hot-165°F. If possible, stir food, cover and allow to stand two to three minutes before serving.			
Soup, Cream 1 cup 1 can (10 3/4 oz)	Refrigerated Room temp.	MEDIUM (50%) 2-5 1/2 min. 5-7 1/2 min.	Cover. Stir after half the time.
Soup, Clear 1 cup 1 can (10 3/4 oz)	Refrigerated Room temp.	HIGH (100%) 2-3 min. 3 1/2-7 min.	Cover. Stir after half the time.
Pizza 1 slice 1 slice 2 slices 2 slices	Room temp. Refrigerated Room temp. Refrigerated	HIGH (100%) 15-25 sec. 25-35 sec. 25-35 sec. 55-60 sec.	Place on paper towel on microwave-safe rack.
Vegetables 1 serving 2 servings	Refrigerated Refrigerated	HIGH (100%) 3/4-1 1/4 min. 1 1/2-2 min.	Cover. Stir after half the time.
Baked Potato 1 2	Refrigerated Refrigerated	HIGH (100%) 1-2 1/2 min. 2 1/2-3 min.	Cut potato lengthwise and then several times crosswise. Cover with wax paper.
Breads (Dinner or breakfast roll) 1 roll 2 rolls 4 rolls	Room temp. Room temp. Room temp.	HIGH (100%) 10-12 sec. 15-18 sec. 25-30 sec.	Wrap single roll, bagel or muffin in paper towel. To reheat several, line plate with paper towel; cover with another paper towel.





POULTRY ROASTING CHART

CUT	COOKING PREPARATION	MICROWAVE PROCEDURE	INTERNAL TEMP. AT REMOVAL	INTERNAL TEMP. AFTER STANDING
CHICKEN				
Whole	Breast side down on rack. Cover with plastic wrap. Turn over halfway through cooking time.	MED.-HIGH (70%) 5-8 min. per lb	170°F	180°F
Pieces	Rack. Cover with plastic wrap. Turn over halfway through cooking time.	HIGH (100%)		
Bone-in		5-7 1/2 min. per lb	170°F	180°F
Boneless		4-7 min. per lb	160°F	170°F
TURKEY				
Whole (up to 10 lb)	Breast side down on rack. Cover with plastic wrap. Turn over halfway through cooking time.	MED. (50%) 10-14 min. per lb	170°F	180°F
Breast	Rack. Cover with plastic wrap. Turn over halfway through cooking time.	MED. (50%)		
Bone-in		11-15 min. per lb	160°F	170°F
Boneless		14-18 min. per lb	160°F	170°F





GUIA AUTO-TOUCH

Para mayor información y precauciones de seguridad, consulte el Manual de Operaciones.

PONER LA HORA

Si en la pantalla se lee **WELCOME PRESS CLEAR AND PRESS CLOCK** toque primero **STOP/CLEAR**.

- 1 Toque el botón que dice **CLOCK** y número **2**.

- 2 Ajuste el reloj en la hora correcta oprimiendo los botones numéricos en el orden respectivo. (Ej: 12:30)

- 3 Toque nuevamente el botón que dice **CLOCK**.

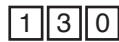

OPERACION MANUAL

Cocimiento con Alta Energía

- 1 Marque el tiempo de cocimiento al oprimir los números. (Ej: 1 min. 30 sec.)

- 2 Pulse la tecla **START/MINUTE PLUS**.

Energía de Cocimiento Variable

- 1 Después de realizar el primer paso (Num. 1 arriba), oprima el **POWER LEVEL** ocho veces para 30%.

- 2 Pulse la tecla **START/MINUTE PLUS**.

INSTANT SENSOR

- 1 Pulse el botón **BAKED POTATOES**.



- 2 Pulse la tecla **START/MINUTE PLUS**.

INSTANT SENSOR TABLA

TIPO DE COMIDA	CANTIDAD
REHEAT	4 a 36 onzas
POPCORN	Bolsa de 2,85 a 3,5 onzas Bolsa de 1,5 a 1,75 onzas
BAKED POTATOES	1 a 6 med.
FRESH VEGETABLES	
Suave	0,25 a 2,0 libras
Firme	0,25 a 1,5 libras

KEEP WARM PLUS

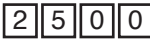
- 1 Pulse la tecla **KEEP WARM PLUS**, esta función trabaja hasta por 30 minutos.

- 2 Capture el tiempo deseado. (Ej: 25:00)

- 3 Pulse la tecla **START/MINUTE PLUS**.

SENSOR COOK CENTER

- 1 Pulse la tecla **SENSOR COOK CENTER** y el número **1** para albondigas.

- 2 Pulse la tecla **START/MINUTE PLUS**.

SENSOR COOK CENTER TABLA

TIPO DE COMIDA	CANTIDAD
1. GROUND MEAT	0,25 a 2,0 libras
2. RICE	0,5 a 2,0 tazas
3. FISH/SEAFOOD	0,25 a 2,0 libras
4. FROZEN ENTREES	6 a 17 onzas
5. CHICKEN BREAST	0,5 a 2,0 libras
6. FROZEN VEGETABLES	0,25 a 1,25 libras

REHEAT

- 1 Pulse la tecla **FRESH ROLLS & MUFFINS** hasta que el número deseado aparezca en pantalla.

- 2 Pulse la tecla **START/MINUTE PLUS**.

REHEAT TABLA

TIPO DE COMIDA	CANTIDAD
FRESH ROLLS/MUFFINS	1 a 8
BEVERAGE	0,5 a 2,0 tazas
FROZEN ROLLS/MUFFINS	1 a 8

MINUTE PLUS

- Oprima **START/MINUTE PLUS** para obtener un minuto al 100% de energía o para agregar otro minuto durante el cocimiento manual. Vuelva a oprimirlo para obtener minutos adicionales.

Carousel® es una marca registrada de Sharp Corporation.



GUÍA AUTO-TOUCH

Continuado de la página 30.

DEFROST CENTER

- 1 Pulse la tecla **DEFROST CENTER** y el número **2** para Bistec/Costillas. Ingrese el peso correspondiente y a continuación pulse la tecla.

DEFROST CENTER

2

2

0

START
MINUTE PLUS
- 2 Después de concluir la 1ra etapa, abra la puerta y levante el bistec, limpie el agua, coloque nuevamente el bistec. Cierre la puerta. Pulse la tecla **START/MINUTE PLUS**.

START
MINUTE PLUS
- 3 Después de la 2da etapa, abra la puerta y repita el proceso del paso 2. Cierre la puerta. Pulse la tecla **START/MINUTE PLUS**.

START
MINUTE PLUS
- 4 Después que el ciclo de descongelamiento concluya, deje reposar el alimento.

DEFROST CENTER TABLA

TIPO DE COMIDA	CANTIDAD
1. GROUND MEAT	0,5 a 2,0 libras
2. STEAKS/CHOPS	0,5 a 3,0 libras
3. BONELESS POULTRY	0,5 a 2,0 libras
4. BONE-IN POULTRY	0,5 a 3,0 libras

HOT WATER

- 1 Pulse la tecla **HOT WATER** tres veces para calentar 3 tazas con agua o manténgalo presionado hasta que la cantidad requerida aparezca en pantalla.

HOT WATER

x 3
- 2 Pulse la tecla **START/MINUTE PLUS**.

START
MINUTE PLUS

AUTO-TOUCH GUIDE

Continued from back cover.

DEFROST CENTER

- 1 Touch **DEFROST CENTER** pad and number **2** for Steaks/Chops. Enter weight 2.0 lb. Touch **START/MINUTE PLUS** pad.

DEFROST CENTER

2

2

0

START
MINUTE PLUS
- 2 After the 1st stage, open the door, turn steak over and shield any warm portions. Close the door. Touch **START/MINUTE PLUS** pad.

START
MINUTE PLUS
- 3 After the 2nd stage, open the door and shield any warm portions. Close the door. Touch **START/MINUTE PLUS** pad.

START
MINUTE PLUS
- 4 After defrost cycle ends, cover and let stand.

DEFROST CENTER CHART

FOOD	AMOUNT
1. GROUND MEAT	.5 - 2.0 lb
2. STEAKS/CHOPS	.5 - 3.0 lb
3. BONELESS POULTRY	.5 - 2.0 lb
4. BONE-IN POULTRY	.5 - 3.0 lb





AUTO-TOUCH GUIDE

For more complete information and safety precautions, refer to your Operation Manual.

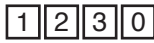

SET CLOCK

If WELCOME PRESS CLEAR AND PRESS CLOCK is in the display, first touch **STOP/CLEAR**.



- 1 Touch **TIMER/CLOCK** pad and number **2**.

- 2 Enter correct time of the day by touching numbers in sequence. (Ex: 12:30)

- 3 Touch **TIMER/CLOCK** pad again.

MANUAL OPERATION



High Power Cooking

- 1 Enter cooking time by touching number pads. (Ex: 1 min. 30 sec.)

- 2 Touch **START/MINUTE PLUS** pad.

Variable Power Cooking

- 1 After Step 1 above, touch **POWER LEVEL** pad eight times for 30%.

- 2 Touch **START/MINUTE PLUS** pad.



INSTANT SENSOR

- 1 Touch **BAKED POTATOES** pad.

- 2 Touch **START/MINUTE PLUS** pad.





INSTANT SENSOR CHART

FOOD	AMOUNT
REHEAT	4 - 36 oz
POPCORN	2.85 - 3.5 oz bag (reg.) 1.5 - 1.75 oz bag (snack)
BAKED POTATOES	1 - 6 med.
FRESH VEGETABLES	.25 - 2.0 lb (soft) .25 - 1.5 lb (hard)

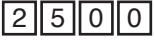

HOT WATER

- 1 Touch **HOT WATER** pad three times to heat 3 cups of water or hold down until desired quantity appears.

- 2 Touch **START/MINUTE PLUS** pad.

KEEP WARM PLUS

- 1 Touch **KEEP WARM PLUS** pad to keep food warm for up to 30 minutes.

- 2 Enter the desired time. (Ex: 25:00)

- 3 Touch **START/MINUTE PLUS** pad.



SENSOR COOK CENTER

- 1 Touch **SENSOR COOK CENTER** pad and number **1** for ground meat.

- 2 Touch **START/MINUTE PLUS** pad.

SENSOR COOK CENTER CHART

FOOD	AMOUNT
1. GROUND MEAT	.25 - 2.0 lb
2. RICE	.5 - 2.0 cups
3. FISH/SEAFOOD	.25 - 2.0 lb
4. FROZEN ENTREES	6 - 17 oz
5. CHICKEN BREAST	.5 - 2.0 lb
6. FROZEN VEGETABLES	.25 - 1.25 lb

REHEAT

- 1 Touch **FRESH ROLLS & MUFFINS** pad until desired number appears in the display.

- 2 Touch **START/MINUTE PLUS** pad.

REHEAT CHART

FOOD	AMOUNT
FRESH ROLLS/MUFFINS	1 - 8
BEVERAGE	.5 - 2.0 cups
FROZEN ROLLS/MUFFINS	1 - 8

MINUTE PLUS

- Touch **START/MINUTE PLUS** for one minute at 100% power or to add a minute during manual cooking. Continue to touch for additional minutes.

Continued on page 31.

Carousel® is a registered trademark of Sharp Corporation.

SHARP®

SHARP ELECTRONICS CORPORATION
100 Paragon Drive • Montvale, New Jersey 07645

TINSEB391WRRZ _ Rev.3

June 4, 2019