

SHARP®

MICROWAVE OVEN OPERATION MANUAL

Carousel®

MODEL

R-120PK



H A L F $\frac{1}{2}$ P I N T

CONTENTS

• For Customer Assistance	2	• Manual Operation	11
• Precautions to Avoid Possible Exposure to Excessive Microwave Energy	2	• Special Features	12
• Consumer Limited Warranty	3	• Other Convenient Features	14
• Product Information Card	3	• Cleaning and Care	14
• Important Safety Instructions	4	• Specifications	15
• Unpacking and Installation Instructions ..	5	• Cookbook Information	15
• Grounding Instructions	5	• Cooking Reference	16
• Information You Need to Know	6	• Cookbook Order Form	16
• Part Names	9	• Conversion Chart	17
• Before Operating	11	• Service Call Check	17
		• Auto-Touch Guide	18

READ ALL INSTRUCTIONS CAREFULLY BEFORE USING THE OVEN.

SHARP ELECTRONICS CORPORATION
Sharp Plaza, Mahwah, NJ 07495-1163

TINSKA028WRRZ-D91
Printed in Thailand

FOR CUSTOMER ASSISTANCE

To aid in reporting this microwave oven in case of loss or theft, please record below the model number and serial number located on the unit. We also suggest you record all the information listed and retain for future reference.

MODEL NUMBER _____	SERIAL NUMBER _____
DATE OF PURCHASE _____	
DEALER _____	TELEPHONE _____
SERVICER _____	TELEPHONE _____

TO PHONE:

DIAL 1-800- BE-SHARP (237-4277) for :

SERVICE (for your nearest Sharp Authorized Servicer)

PARTS (for your authorized parts distributor)

ADDITIONAL CUSTOMER INFORMATION

ACCESSORIES and COOKBOOK

TO WRITE:

Sharp Electronics Corporation

Customer Assistance Center

1300 Naperville Drive

Romeoville, IL 60446-1091

TO ACCESS INTERNET: www.sharppusa.com

Please provide the following information when you write or call: model number, serial number, date of purchase, your complete mailing address (including zip code), your daytime telephone number (including area code) and description of the problem.

PRECAUTIONS TO AVOID POSSIBLE EXPOSURE TO EXCESSIVE MICROWAVE ENERGY

- (a) Do not attempt to operate this oven with the door open since open-door operation can result in harmful exposure to microwave energy. It is important not to defeat or tamper with the safety interlocks.
- (b) Do not place any object between the oven front face and the door or allow soil or cleaner residue to accumulate on sealing surfaces.
- (c) Do not operate the oven if it is damaged. It is particularly important that the oven door close properly and that there is no damage to the: (1) door (bent), (2) hinges and latches (broken or loosened), (3) door seals and sealing surfaces.
- (d) The oven should not be adjusted or repaired by anyone except properly qualified service personnel.

CONSUMER LIMITED WARRANTY

SHARP ELECTRONICS CORPORATION warrants to the first consumer purchaser that this Sharp brand product (the "Product"), when shipped in its original container, will be free from defective workmanship and materials, and agrees that it will, at its option, either repair the defect or replace the defective Product or part thereof with a new or remanufactured equivalent at no charge to the purchaser for parts or labor for the period(s) set forth below.

This warranty does not apply to any appearance items of the Product nor to the additional excluded item(s) set forth below nor to any Product the exterior of which has been damaged or defaced, which has been subjected to improper voltage or other misuse, abnormal service or handling, or which has been altered or modified in design or construction.

In order to enforce the rights under this limited warranty, the purchaser should follow the steps set forth below and provide proof of purchase to the servicer.

The limited warranty described herein is in addition to whatever implied warranties may be granted to purchasers by law. ALL IMPLIED WARRANTIES INCLUDING THE WARRANTIES OF MERCHANTABILITY AND FITNESS FOR USE ARE LIMITED TO THE PERIOD(S) FROM THE DATE OF PURCHASE SET FORTH BELOW. Some states do not allow limitations on how long an implied warranty lasts, so the above limitation may not apply to you.

Neither the sales personnel of the seller nor any other person is authorized to make any warranties other than those described herein, or to extend the duration of any warranties beyond the time period described herein on behalf of Sharp.

The warranties described herein shall be the sole and exclusive warranties granted by Sharp and shall be the sole and exclusive remedy available to the purchaser. Correction of defects, in the manner and for the period of time described herein, shall constitute complete fulfillment of all liabilities and responsibilities of Sharp to the purchaser with respect to the Product, and shall constitute full satisfaction of all claims, whether based on contract, negligence, strict liability or otherwise. In no event shall Sharp be liable, or in any way responsible, for any damages or defects in the Product which were caused by repairs or attempted repairs performed by anyone other than an authorized servicer. Nor shall Sharp be liable or in any way responsible for any incidental or consequential economic or property damage. Some states do not allow the exclusion of incidental or consequential damages, so the above exclusion may not apply to you.

THIS WARRANTY GIVES YOU SPECIFIC LEGAL RIGHTS. YOU MAY ALSO HAVE OTHER RIGHTS WHICH VARY FROM STATE TO STATE.

Your Product Model Number & Description:

R-120PK, Home Use Carousel Microwave Oven. (Be sure to have this information available when you need service for your Product.)

Warranty Period for this Product:

One (1) year parts and labor. The warranty period continues for an additional four (4) years, for a total of five (5) years, with respect to the magnetron tube in the Product for parts only; labor and service are not provided free of charge for this additional period.

Additional Item(s) Excluded from Warranty Coverage (if any):

Non-functional accessories, turntable and light bulb.

Where to Obtain Service:

From a Sharp Authorized Servicer located In the United States. To find the location of the nearest Sharp Authorized Servicer, call Sharp toll free at 1-800-BE-SHARP (1-800-237-4277).

What to do to Obtain Service:

Ship prepaid or carry in your Product to a Sharp Authorized Servicer. Be sure to have **Proof of Purchase** available. If you ship the Product, be sure it is insured and packaged securely.

TO OBTAIN SUPPLY, ACCESSORY OR PRODUCT INFORMATION, CALL

1-800-BE-SHARP OR VISIT www.sharppusa.com.

Save the proof of purchase as it is needed should your oven ever require warranty service.

PRODUCT INFORMATION CARD

The product information card which is on the inside of the microwave oven carton should be completed within ten days of purchase and returned. We will keep it on file and help you access the information in case of loss, damage or theft. This will also enable us to contact you in the unlikely event that any adjustments or modifications are ever required for your oven.

IMPORTANT SAFETY INSTRUCTIONS

When using electrical appliances basic safety precautions should be followed, including the following:

WARNING - To reduce the risk of burns, electric shock, fire, injury to persons or exposure to excessive microwave energy:

1. **Read all instructions before using the appliance.**
2. Read and follow the specific **“PRECAUTIONS TO AVOID POSSIBLE EXPOSURE TO EXCESSIVE MICROWAVE ENERGY”** on page 2.
3. This appliance must be grounded. Connect only to properly grounded outlet. See **“GROUNDING INSTRUCTIONS”** on page 5.
4. Install or locate this appliance only in accordance with the provided installation instructions.
5. Some products such as whole eggs and sealed containers — for example, closed glass jars — are able to explode and should not be heated in this oven.
6. Use this appliance only for its intended use as described in this manual. Do not use corrosive chemicals or vapors in this appliance. This type of oven is specifically designed to heat, cook or dry food. It is not designed for industrial or laboratory use.
7. As with any appliance, close supervision is necessary when used by children.
8. Do not operate this appliance if it has a damaged cord or plug, if it is not working properly or if it has been damaged or dropped.
9. This appliance should be serviced only by qualified service personnel. Contact nearest Sharp Authorized Servicer for examination, repair or adjustment.
10. Do not cover or block any openings on the appliance.
11. Do not store or use this appliance outdoors. Do not use this product near water—for example, near a kitchen sink, in a wet basement or near a swimming pool, or similar locations.
12. Do not immerse cord or plug in water.
13. Keep cord away from heated surfaces.
14. Do not let cord hang over edge of table or counter.
15. See door surface cleaning instructions on page 14.
16. To reduce the risk of fire in the oven cavity:
 - a. Do not overcook food. Carefully attend to appliance when paper, plastic or other combustible materials are placed inside the oven to facilitate cooking.
 - b. Remove wire twist-ties from paper or plastic bags before placing bag in oven.
 - c. **If materials inside the oven ignite, keep oven door closed, turn oven off and disconnect the power cord or shut off power at the fuse or circuit breaker panel.**
 - d. Do not use the cavity for storage purposes. Do not leave paper products, cooking utensils or food in the cavity when not in use.
17. Liquids, such as water, coffee or tea are able to be overheated beyond the boiling point without appearing to be boiling. Visible bubbling or boiling when the container is removed from the microwave oven is not always present. **THIS COULD RESULT IN VERY HOT LIQUIDS SUDDENLY BOILING OVER WHEN A SPOON OR OTHER UTENSIL IS INSERTED INTO THE LIQUID.** To reduce the risk of injury to persons:
 - a. Do not overheat the liquid.
 - b. Stir the liquid both before and halfway through heating it.
 - c. Do not use straight-sided containers with narrow necks. Use a wide-mouthed container.
 - d. After heating, allow the container to stand in the microwave oven at least for 20 seconds before removing the container.
 - e. Use extreme care when inserting a spoon or other utensil into the container.
18. If the oven light fails, consult a SHARP AUTHORIZED SERVICER.

SAVE THESE INSTRUCTIONS

UNPACKING AND INSTALLATION INSTRUCTIONS

Unpacking and Examining Your Oven

1. Remove all packing materials from inside the oven cavity; however, **DO NOT REMOVE THE WAVEGUIDE COVER**, which is located on the top cavity wall. Read enclosures and **SAVE** the Operation Manual.

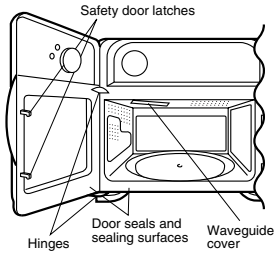

2. Remove the feature sticker, if there is one, from the outside of the door.

Check the oven for any damage, such as misaligned or bent door, damaged door seals and sealing surfaces, broken or loose door hinges and

latches and dents inside the cavity or on the door. If there is any damage, do not operate the oven and contact your dealer or SHARP AUTHORIZED SERVICER.

Choosing a Location for Your Oven

You will use the oven frequently so plan its location for ease of use. It's wise, if possible, to have counter space on at least one side of the oven. Allow at least 2 inches (50 mm) on the sides, top and at the rear of the oven for air circulation. Do not place or install the oven in any area where heat and steam are generated; for example, next to or above a conventional gas or electric range or above a conventional wall oven. Heat and steam may damage the electronics or the mechanical parts of the oven.

GROUNDING INSTRUCTIONS

This appliance must be grounded. This oven is equipped with a cord having a grounding wire with a grounding plug. It must be plugged into a wall receptacle that is properly installed and grounded in accordance with the National Electrical Code and local codes and ordinances. In the event of an electrical short circuit, grounding reduces risk of electric shock by providing an escape wire for the electric current.

WARNING – Improper use of the grounding plug can result in a risk of electric shock.

Electrical Requirements

The electrical requirements are a 120 volt 60 Hz, AC only, 15 amp. or more protected electrical supply. It is recommended that a separate circuit serving only this appliance be provided.

The oven is equipped with a 3-prong grounding plug. It must be plugged into a wall receptacle that is properly installed and grounded. Should you only have a 2-prong outlet, have a qualified electrician install a correct wall receptacle.

A 3-prong adapter may be purchased and used temporarily with a grounded receptacle box if local codes allow. Follow package directions.

A short power-supply cord is provided to reduce risk of becoming entangled in or tripping over a longer cord.

Extension Cord

If it is necessary to use an extension cord, use only a 3-wire extension cord that has a 3-blade grounding plug and a 3-slot receptacle that will accept the plug on the microwave oven. The marked rating of the extension cord should be AC 115-120 volt, 15 amp. or more.

Be careful not to drape the cord over the countertop or table where it can be pulled on by children or tripped over accidentally.

Notes: 1. If you have any questions about the grounding or electrical instructions, consult a qualified electrician or service person.

2. Neither Sharp nor the dealer can accept any liability for damage to the oven or personal injury resulting from failure to observe the correct electrical connection procedures.

Radio or TV Interference

Should there be any interference caused by the microwave oven to your radio or TV, check that the microwave oven is on a different electrical circuit, relocate the radio or TV as far away from the oven as feasible or check position and signal of receiving antenna.

Permanent and Correct Installation

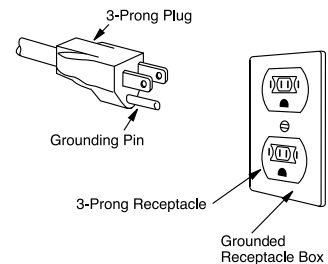

Temporary Use

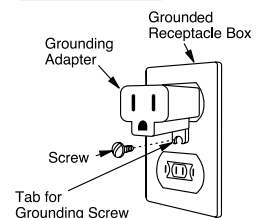

INFORMATION YOU NEED TO KNOW

ABOUT YOUR OVEN

This Operation Manual is valuable: read it carefully and always save it for reference.

A good microwave cookbook is a valuable asset. Check it for microwave cooking principles, techniques, hints and recipes. See pages 15 and 16 for ordering the Cook Information, the SHARP CAROUSEL MICROWAVE COOKBOOK.

NEVER use the oven without the turntable and support nor turn the turntable over so that a large dish could be placed in the oven. The turntable will turn both clockwise and counterclockwise.

ALWAYS have food in the oven when it is on to absorb the microwave energy.

When using the oven for Express Defrost, you may hear the magnetron cycling on and off. It is normal for the exterior of the oven to be warm to the touch when cooking or reheating.

Condensation is a normal part of microwave cooking. Room humidity and the moisture in food will influence the amount of moisture that condenses in the oven. Generally, covered foods will not cause as much condensation as uncovered ones. Vents on the oven back must not be blocked.

The oven is for food preparation only. It should not be used to dry clothes or newspapers.

Your oven is rated 600 watts by using the IEC Test Procedure. In using recipes or package directions, check food at the minimum time and add time accordingly.

ABOUT FOOD

FOOD	DO	DON'T
Eggs, sausages, nuts, seeds fruits & vegetables	<ul style="list-style-type: none"> • Puncture egg yolks before cooking to prevent "explosion". • Pierce skins of potatoes, apples, squash, hot dogs and sausages so that steam escapes. 	<ul style="list-style-type: none"> • Cook eggs in shells. • Reheat whole eggs. • Dry nuts or seeds in shells.
Popcorn	<ul style="list-style-type: none"> • Use specially bagged popcorn for the microwave oven. • Listen while popping corn for the popping to slow to 1 or 2 seconds or use special POPCORN pad. • Place carefully so bag does not touch oven walls. The corners of the bag may be folded down. 	<ul style="list-style-type: none"> • Pop popcorn in regular brown bags or glass bowls. • Exceed maximum time on popcorn package.
Baby food	<ul style="list-style-type: none"> • Transfer baby food to small dish and heat carefully, stirring often. Check temperature before serving. • Put nipples on bottles after heating and shake thoroughly. "Wrist" test before feeding. 	<ul style="list-style-type: none"> • Heat disposable bottles. • Heat bottles with nipples on. • Heat baby food in original jars.
General	<ul style="list-style-type: none"> • Cut baked goods with filling after heating to release steam and avoid burns. • Stir liquids briskly before heating and allow to stand at least for 20 seconds after heating before stirring or drinking to avoid eruption. • Use deep bowl, when cooking liquids or cereals, to prevent boilovers. 	<ul style="list-style-type: none"> • Heat or cook in closed glass jars or air tight containers. • Can in the microwave as harmful bacteria may not be destroyed. • Deep fat fry. • Dry wood, gourds, herbs or wet papers.

ABOUT UTENSILS AND COVERINGS

It is not necessary to buy all new cookware. Many pieces already in your kitchen can be used successfully in your new microwave oven. Make sure the utensil does not touch the interior walls during cooking.

Use these utensils for safe microwave cooking and reheating:

- glass ceramic (Pyroceram®), such as Corningware®.
- heat-resistant glass (Pyrex®)
- microwave-safe plastics
- paper plates
- microwave-safe pottery, stoneware and porcelain
- browning dish (Do not exceed recommended preheating time. Follow manufacturer's directions.)

These items can be used for short time reheating of foods that have little fat or sugar in them:

- wood, straw, wicker

DO NOT USE

- metal pans and bakeware
- dishes with metallic trim
- non-heat-resistant glass
- non-microwave-safe plastics (margarine tubs)
- recycled paper products
- brown paper bags
- food storage bags
- metal twist-ties

Should you wish to check if a dish is safe for microwaving, place the empty dish in the oven and microwave on HIGH for 30 seconds. A dish which becomes very hot should not be used.

ABOUT CHILDREN AND THE MICROWAVE

Children below the age of 7 should use the microwave oven with a supervising person very near to them. Between the ages of 7 and 12, the supervising person should be in the same room.

The child must be able to reach the oven comfortably; if not, he/she should stand on a sturdy stool.

At no time should anyone be allowed to lean or swing on the oven door.

The following coverings are ideal:

- Paper towels are good for covering foods for reheating and absorbing fat while cooking bacon.
- Wax paper can be used for cooking and reheating.
- Plastic wrap that is specially marked for microwave use can be used for cooking and reheating. DO NOT allow plastic wrap to touch food. Vent so steam can escape.
- Lids that are microwave-safe are a good choice because heat is kept near the food to hasten cooking.
- Oven cooking bags are good for large meats or foods that need tenderizing. DO NOT use metal twist ties. Remember to slit bag so steam can escape.

How to use aluminum foil in your microwave oven:

- Small flat pieces of aluminum foil placed smoothly on the food can be used to shield areas that are either defrosting or cooking too quickly.
- Foil should not come closer than one inch to any surface of the oven.

Should you have questions about utensils or coverings, check a good microwave cookbook or follow recipe suggestions.

ACCESSORIES There are many microwave accessories available for purchase. Evaluate carefully before you purchase so that they meet your needs. A microwave-safe thermometer will assist you in determining correct doneness and assure you that foods have been cooked to safe temperatures. Sharp is not responsible for any damage to the oven when accessories are used.

INFORMATION YOU NEED TO KNOW

ABOUT MICROWAVE COOKING

- Arrange food carefully. Place thickest areas towards outside of dish.
- Watch cooking time. Cook for the shortest amount of time indicated and add more as needed. Food severely overcooked can smoke or ignite.
- Cover foods while cooking. Check recipe or cook-book for suggestions: paper towels, wax paper, microwave plastic wrap or a lid. Covers prevent spattering and help foods to cook evenly.
- Shield with small flat pieces of aluminum foil any thin areas of meat or poultry to prevent overcooking before dense, thick areas are cooked thoroughly.
- Stir foods from outside to center of dish once or twice during cooking, if possible.
- Turn foods over once during microwaving to speed cooking of such foods as chicken and hamburgers. Large items like roasts must be turned over at least once.
- Rearrange foods such as meatballs halfway through cooking both from top to bottom and from the center of the dish to the outside.
- Add standing time. Remove food from oven and stir, if possible. Cover for standing time which allows the food to finish cooking without overcooking.
- Check for doneness. Look for signs indicating that cooking temperatures have been reached.

Doneness signs include:

- Food steams throughout, not just at edge.
- Center bottom of dish is very hot to the touch.
- Poultry thigh joints move easily.
- Meat and poultry show no pinkness.
- Fish is opaque and flakes easily with a fork.

ABOUT SAFETY

- Check foods to see that they are cooked to the United States Department of Agriculture's recommended temperatures.

TEMP	FOOD
145°F (63°C)	... for beef, lamb or veal cut into steaks, chops or roasts, fish
160°F (71°C)	... for fresh pork, ground meat, fish, seafood, egg dishes, frozen prepared food and beef, lamb or veal cut into steaks, chops or roasts
165°F (74°C)	... for leftover, ready-to-reheat refrigerated, deli and carry out "fresh" food, whole chicken or turkey, chicken or turkey breasts and ground poultry used in chicken or turkey burgers. NOTE: Do not cook whole, stuffed poultry. Cook stuffing separately to 165°F (74°C).

To test for doneness, insert a meat thermometer in a thick or dense area away from fat or bone. NEVER leave the thermometer in the food during cooking, unless it is approved for microwave oven use.

- ALWAYS use the door handle when opening/closing the door.
- ALWAYS use potholders to prevent burns when handling utensils that are in contact with hot food. Enough heat from the food can transfer through utensils to cause skin burns.
- Avoid steam burns by directing steam away from the face and hands. Slowly lift the farthest edge of a dish's covering and carefully open popcorn and oven cooking bags away from the face.
- Stay near the oven while it's in use and check cooking progress frequently so that there is no chance of overcooking food.
- NEVER use the cavity for storing cookbooks or other items.
- Select, store and handle food carefully to preserve its high quality and minimize the spread of foodborne bacteria.
- Keep waveguide cover clean. Food residue can cause arcing and/or fires.
- Use care when removing items from the oven so that the utensil, your clothes or accessories do not touch the safety door latches.

PART NAMES

MICROWAVE OVEN PARTS

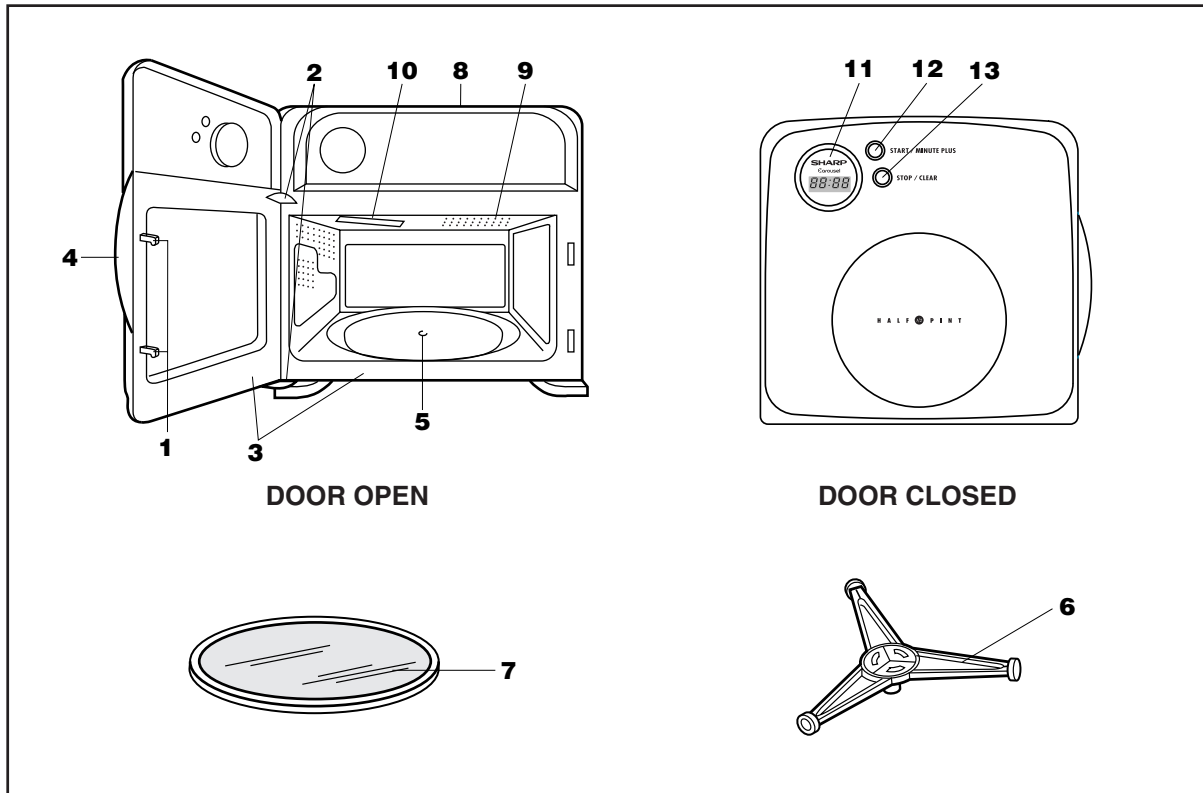

1 Safety door latches

The oven will not operate unless the door is securely closed.

2 Door hinges

3 Door seals and sealing surfaces

4 Door handle

Pull to open door.

5 Turntable motor shaft

6 Removable turntable support

7 Removable turntable

Place the turntable on the turntable support securely. The turntable will rotate clockwise or counterclockwise. Only remove for cleaning.

8 Ventilation openings (Rear)

9 Oven light

It will light when oven is operating.

10 Waveguide cover: DO NOT REMOVE.

11 Control panel display

12 Start/Minute Plus pad

13 Stop/Clear pad

PART NAMES

TOUCH CONTROL PANEL

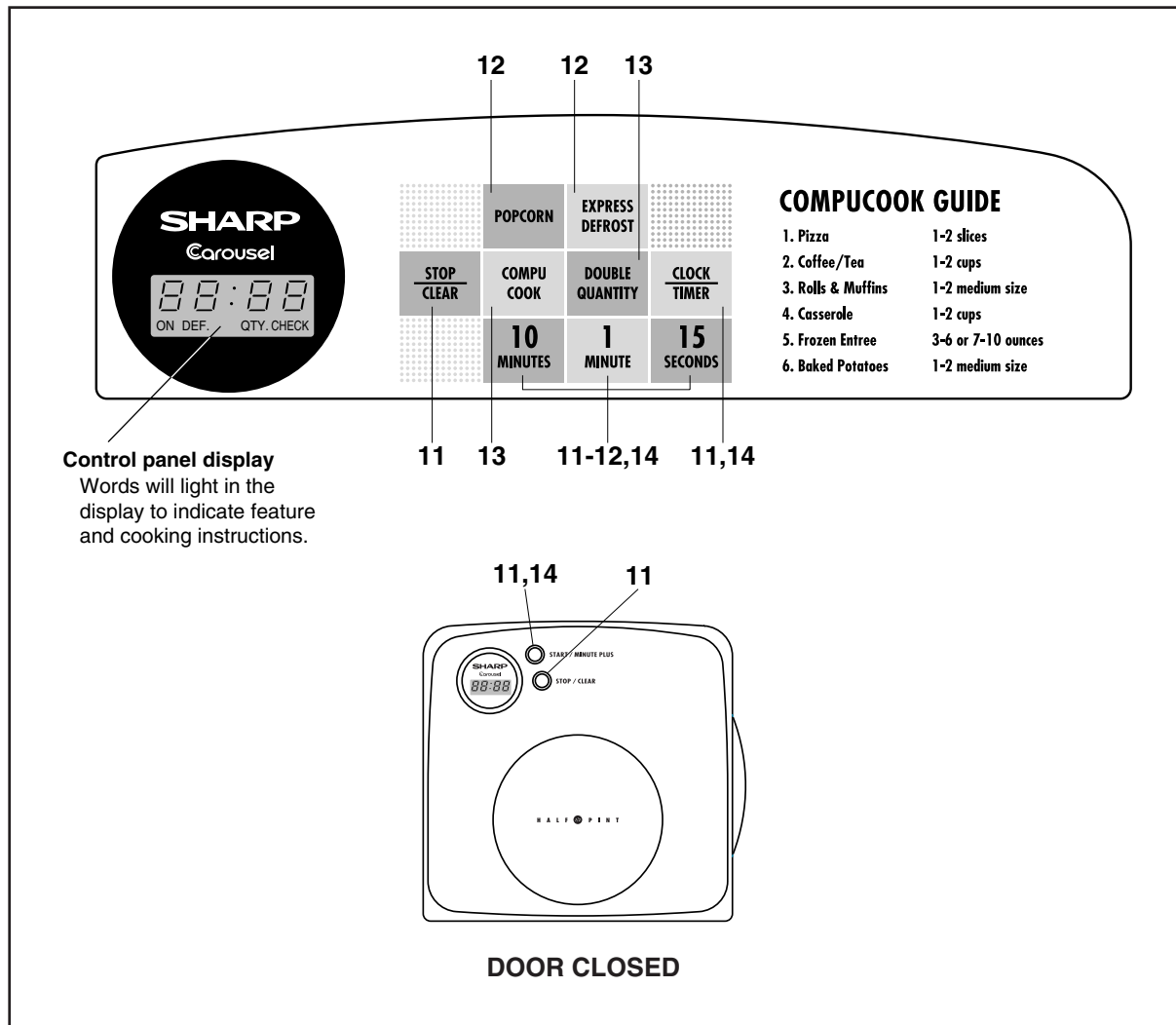

Control panel display

Words will light in the display to indicate feature and cooking instructions.

Number indicates page on which there are a feature description and usage information.

NOTE: Open the door to program the oven.













The **STOP/CLEAR** and the **START/MINUTE PLUS** pads can be used even if the door is closed.

BEFORE OPERATING

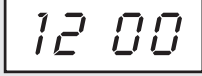
- Before operating your new microwave oven, be sure to read and understand this operation manual completely.
- Before the oven can be used, follow these procedures:
 1. Plug in the oven. Close the door. The oven display will then begin flashing [88:88].
 2. Touch the **STOP/CLEAR** pad. [:] will appear.
 3. Touch the **CLOCK/TIMER** pad to set clock.

TO SET THE CLOCK

- Suppose you want to enter the correct time of day 12:35 (A.M. or P.M.).

PROCEDURE	DISPLAY
1  Open the door and touch the CLOCK pad.	
2   x 1 x 2 Enter the correct time of day (hours) by touching the 10 MINUTES and 1 MINUTE pads.	
3  Touch the CLOCK pad again.	
4   x 3 x 5 Enter the correct time of day (minutes) by touching the 10 MINUTES and 1 MINUTE pads.	
5  Touch the CLOCK pad again.	

This is a 12 hour clock.

- If the electrical power supply to your microwave oven should be interrupted, the display will intermittently show [88:88] after the power is reinstated. If this occurs during cooking, the program will be erased. The time of day will also be erased. Simply touch the **STOP/CLEAR** pad and reset the clock for the correct time of day.

STOP/CLEAR

Touch the **STOP/CLEAR** pad to:





1. Erase if you make a mistake during programming.
2. Cancel timer.
3. Stop the oven temporarily during cooking.
4. Return the time of day to the display.
5. Cancel a program during cooking, touch twice.

MANUAL OPERATION

TIME COOKING

Your oven can be programmed for 99 minutes 45 seconds (99.45). The oven has only HIGH (100%) power level.

- Suppose you want to cook 2 minutes 30 seconds.

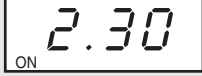

PROCEDURE	DISPLAY
1   x 2 x 2 Open the door and enter cooking time. Close the door.	
2  START/MINUTEPLUS Touch the START pad.	

SPECIAL FEATURES





POPCORN

The popcorn settings automatically provide the correct cooking time for most brands of microwave popcorn. See the chart below.

- Suppose you want to pop 3.5 oz. bag of light microwave popcorn.

PROCEDURE	DISPLAY
1  x 2 Open the door and touch the POPCORN pad twice.	
2  START/MINUTEPLUS Close the door and touch the START pad.	









POPCORN CHART

AMOUNT	PROCEDURE
1 bag	Use only popcorn packaged for microwave oven use. Try several brands to decide which is most acceptable for your taste. Place bag with only one fold slightly off center and place bag with two folds in the center of the turntable. You may also fold down the corners of the bag so it turns freely.
3.5 oz bag (100 g)	Touch POPCORN pad once for regular.  .
3.0 or 3.5 oz bag (90 - 100 g) (Light)	Touch POPCORN pad twice for light regular.  .
1.75 oz bag (50 g)	Touch POPCORN pad three times for snack.  .
1.5 or 1.75 oz bag (45 - 50 g) (Light)	Touch POPCORN pad four times for light snack.  .

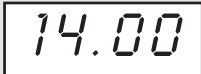
EXPRESS DEFROST

Express Defrost automatically defrosts foods shown in the chart below. Check the chart to determine appropriate time.

- Suppose you want to defrost a 2.0 pound steak (1 1/2" thick) for 14 minutes.

PROCEDURE	DISPLAY
1  x 1  x 4 Open the door and enter the defrost time.	
2  EXPRESS DEFROST Touch the EXPRESS DEFROST pad.	
3  START/MINUTEPLUS Close the door and touch the START pad.	
The oven will stop and the CHECK indicator will flash. The food should be checked and turned over and/or shielded.	
4 After the 1st stage, open the door, turn steak over and shield any warm portions. Close the door.  START/MINUTEPLUS Touch the START pad.	
5 After the 2nd stage, open the door and shield any warm portions. Close the door.  START/MINUTEPLUS Touch the START pad.	
6 After defrost cycle ends, cover and let stand for time indicated in chart.	

EXPRESS DEFROST CHART



FOOD	AMOUNT	TIME (MIN/LB)	PROCEDURE
1. Steaks, chops	0.5 - 4.0 lb (0.3 - 1.8 kg) Less than 1" 2.5 cm thick More than 1" 2.5 cm thick	6 - 6 1/2 7 - 7 1/2	After the 1st stage, turn over and shield the warm portions with aluminum foil. After the 2nd stage, if there are warm portions, shield with aluminum foil. A "collar" of foil around entire edge works well with thick steaks. Allow to stand, covered, for 10 to 20 minutes.
2. Ground meat	0.5 - 1.0 lb (0.3 - 0.5 kg) 1.1 - 3.0 lb (0.6 - 1.3 kg)	6 - 6 1/2 6 1/2 - 7	Remove any thawed pieces after at pause. Allow to stand, covered, for 5 to 10 minutes.
3. Chicken pieces	0.5 - 3.0 lb (0.3 - 1.3 kg)	5 1/2 - 6	At pause, turn over and rearrange. If there are warm portions, shield with aluminum foil. Allow to stand, covered, for 10 to 20 minutes.

SPECIAL FEATURES

COMPUCOOK

The CompuCook setting will automatically provide the correct cooking/reheating time for foods shown in the chart below.

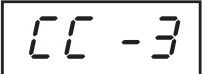
- Suppose you want to use CompuCook to reheat a fresh roll.

PROCEDURE	DISPLAY
<p>1  x 3</p> <p>Open the door and touch the COMPU COOK pad until the desired menu number is displayed.</p>	
<p>2  START/MINUTEPLUS</p> <p>Close the door and touch the START pad.</p>	

To cook double quantity, touch the **DOUBLE QUANTITY** pad prior to touching the **START** pad.

NOTE: More or less food than the quantity listed in the chart should be cooked following the guidelines in any microwave cookbook.



COMPUCOOK CHART

DISPLAY	MENU/AMOUNT (DOUBLE QUANTITY)	PROCEDURE
CC-1	Pizza (Reheat) 1 slice 2 slices	Use this pad to reheat refrigerated leftover pizza. 1 slice is approximately 1/8th of a 12 inch pizza or 1/12th of a 16 inch pizza. Place on paper towel.
CC-2	Coffee/Tea 1 cup 2 cups	Use this setting for heating COLD TAP WATER to a temperature somewhat below the boiling point to make instant coffee or tea. Stir liquid briskly before and after heating to avoid "eruption".
CC-3	Rolls & Muffins 1 medium 2 medium	Wrap in paper towel.
CC-4	Casserole 1 cup 2 cups	Use this pad to reheat refrigerated canned or homemade pasta with sauce or other cooked casserole. For pasta without sauce, measure 2 cups of cooked noodles and program for 1 cup. Cover with lid or plastic wrap. After cooking, stir and let stand, covered, 2 to 3 minutes.
CC-5	Frozen Entree 3 - 6 oz (90 - 170 g) 7 - 10 oz (200 - 280 g)	Use this pad for frozen, convenience foods. It will give satisfactory results for most brands. You may wish to try several and choose your favorite. Remove package from outer wrapping and follow package directions for covering. After cooking, let stand covered for 1 to 3 minutes. 3 - 6 oz : Touch the COMPU COOK pad five times for packages weighing 3 - 6 oz. 7 - 10 oz : Touch the DOUBLE QUANTITY pad prior to touching the START pad for packages weighing 7 - 10 oz.  will appear in the display.
CC-6	Baked Potatoes 1 medium 2 medium	Pierce with fork in several places; place on paper towel on turntable. At end of cooking time, remove from oven, wrap in foil and let stand 10 minutes.

OTHER CONVENIENT FEATURES

TIMER

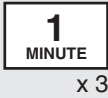
- Suppose you want to time a 3-minute long distance phone call.

PROCEDURE		
1		Open the door and enter time.
2		Touch the TIMER pad. The timer will start automatically. You can close the door.

The timer will operate even if the door is open or closed.

MINUTE PLUS

Minute Plus allows you to cook for a minute at HIGH power level by simply touching the **MINUTE PLUS** pad. You can also extend cooking time in multiples of 1 minute by repeatedly touching the **MINUTE PLUS** pad during manual cooking. The door must be securely closed to use Minute Plus.

- Suppose you want to heat a cup of soup for one minute.

PROCEDURE		
1		Touch the MINUTE PLUS pad.

NOTE: 1. To use Minute Plus, touch pad within 3 minutes after cooking, closing the door, touching the **STOP/CLEAR** pad or during cooking.

2. Minute Plus cannot be used with **SPECIAL FEATURES**.

CLEANING AND CARE

Exterior

The outside surface is painted. Clean the outside with mild soap and water; rinse and dry with a soft cloth. Do not use any type of household or abrasive cleaner.

Door

Wipe on both sides with a soft, damp cloth to remove any spills or splatters. Metal parts will be easier to maintain if wiped frequently with a damp cloth. Avoid the use of spray and other harsh cleaners as they may stain, streak or dull the door surface.

Touch Control Panel

Care should be taken in cleaning the touch control panel. If the control panel becomes soiled, open the oven door and wipe the panel with a cloth dampened slightly with water only. Dry with a soft cloth. Do not scrub or use any sort of chemical cleaners. Close door and touch the **STOP/CLEAR** pad.

Interior

Cleaning is easy because little heat is generated to the interior surfaces; therefore, there is no baking and setting of spills or spattering. To clean the interior surfaces, wipe with a soft cloth and warm water. **DO NOT USE ABRASIVE OR HARSH CLEANERS OR SCOURING PADS.** For heavier soil, use baking soda or a mild soap; rinse thoroughly with hot water. **NEVER**

SPRAY OVEN CLEANERS DIRECTLY ONTO ANY PART OF THE OVEN.

Waveguide Cover

The waveguide cover is made from mica so requires special care. Keep the waveguide cover clean to assure good oven performance. Carefully wipe with a damp cloth any food splatters from the surface of the cover immediately after they occur. Built-up splashes may overheat and cause smoke or possibly catch fire. Do not remove the waveguide cover.

Odor Removal

Occasionally, a cooking odor may remain in the oven. To remove, combine 1 cup water, grated peel and juice of 1 lemon and several whole cloves in a 2-cup glass measuring cup. Boil for several minutes using 100% power. Allow to set in oven until cool. Wipe interior with a soft cloth.

Turntable/Turntable Support

The turntable and turntable support can be removed for easy cleaning. Wash them in mild, sudsy water; for stubborn stains use a mild cleanser and a non-abrasive scouring sponge. They are also dishwasher-safe. The turntable motor shaft is not sealed, so excess water or spills should be wiped up immediately.

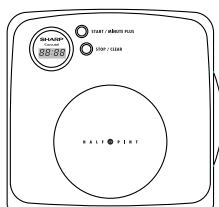

Exterior

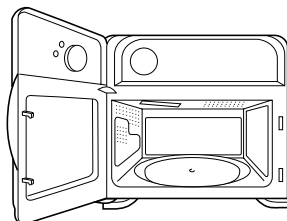

Interior



Turntable



Turntable Support

SPECIFICATIONS

AC Line Voltage:	Single phase 120V, 60Hz, AC only
AC Power Required:	960W
Output Power:	
Microwave	600W* (IEC Test Procedure)
Frequency:	2450 MHz (Group 2/Class B)**
Outside Dimensions:	365mm/14 ³ / ₈ "(W) x 360mm/14 ¹ / ₈ "(H) x 357mm/14"(D)
Cavity Dimensions***:	299mm/11 ³ / ₄ "(W) x 153mm/6"(H) x 302mm/11 ⁷ / ₈ "(D)
Oven Capacity:	0.5 Cu.Ft.
Cooking Uniformity:	Turntable system
Weight:	Approx. 11kg/24lbs

- ★ The International Electrotechnical Commission's standardized method for measuring output wattage. This test method is widely recognized.
- ★★ This is the classification of ISM (Industrial, Scientific and Medical) equipment described in the International Standard CISPR11.
- ★★★ Internal capacity is calculated by measuring maximum width, depth and height. Actual capacity for holding food is less.

In Compliance with Standards set by:

FCC – Federal Communications Commission Authorized.

DHHS – Complies with Department of Health and Human Services (DHHS) rule, CFR, Title 21 Chapter I, Subchapter J.

Health Canada – Complies with Health Canada, Radiation Emitting Device Regulation for microwave oven.



– This symbol on the nameplate means the product is listed by Underwriters Laboratories, Inc. for both the UL and CSA (Canadian Standard Association) standards.

COOKBOOK INFORMATION

125 GREAT RECIPES

- All about your microwave
- Color photos
- Step-by-step instructions
- Durable wipe-clean soft cover with 192 7" x 10" pages
- Helpful tips and special techniques

SHARP® MICROWAVE OVEN COOKBOOK

TO ORDER

Simply call this toll-free number : **1-800-237-4277**. Please have your credit card ready.

If you prefer to order by mail, complete and return the order form on page 16. Please include check or money order (payable to Sharp Electronics Corporation) for \$14.00 plus \$4.50 shipping & handling and tax, if applicable, per book.

SATISFACTION GUARANTEED

You must be completely satisfied with the Sharp Microwave Oven Cookbook. If, within 14 days, you are dissatisfied for any reason, simply return the book and we'll gladly refund your \$14.00 plus tax.

(SOLELY WRITTEN IN ENGLISH!)

COOKING REFERENCE

MEATS, POULTRY, FISH, SEAFOOD

Allow standing time after cooking.

FOOD	TIME
Bacon	3/4 - 1 1/4 min./slice
Frankfurter in Bun	3/4 - 1 1/2 minutes
Ground Beef for Casseroles 450 g (1 lb)	4 - 6 minutes
Hamburger Patties(2)	1st side 2 minutes 2nd side 1 1/2 to 2 1/2 minutes
Ham slice 450 g (1 lb)	4 - 7 minutes
Meatloaf 700 g (1 1/2 lbs)	12 - 18 minutes
Boneless Chicken Breasts	1st side 2 minutes 2nd side 2 - 4 minutes
Chicken Pieces	4 - 8 minutes/lb
Fish Fillets 450 g (1lb)	5 - 6 minutes
Fish Steaks	5 - 8 minutes
Scallops and Shrimp 450 g (1lb)	3 - 5 minutes
Check internal temperature after standing. See chart on page 7.	

REHEATING

Food should be very hot (165°F). Stir before serving, if possible.

FOOD	TIME
Meat Slices	1/2 - 1 min./slice
Non-Stirrable Casseroles (1 serving) (2 servings)	2 - 3 minutes 5 - 7 minutes
Pie (1 slice)	10 - 30 seconds
Soup (1 serving) (2 servings)	2 - 3 minutes 4 - 5 minutes
Vegetables (1 serving) (2 servings)	3/4 - 1 1/2 minutes 1 1/2 - 2 1/2 minutes

OTHER

FOOD	TIME
Applesauce (4)	5 - 8 minutes
Baked Apples (4)	4 - 6 minutes
Chocolate (melt 1 square)	3/4 - 1 1/2 minutes
Eggs, scrambled (2)	1 - 1 1/2 minutes
Hot Cereal (1 serving)	1 - 3 minutes
Nachos (large plate)	3/4 - 1 1/2 minutes

----- Cut along this line. -----

COOKBOOK ORDER FORM

Please send me _____ cookbooks at \$18.50 each \$ _____

Illinois sales tax, (if applicable) per book \$.91 no. of books _____ \$ _____

TOTAL ORDER AMOUNT \$ _____

I have enclosed a check made payable to Sharp Electronics Corporation.

Please bill my VISA MASTERCARD AMERICAN EXPRESS

Acct. No. _____ Expiration date ____ / ____

Signature _____

(All credit card orders must be signed.)

Name _____

Address _____

City _____ State _____ Zip _____

Daytime Phone No. () _____

Mail to: Sharp Electronics Corporation
Attention: Customer Assistance Center
1300 NAPERVILLE DRIVE
Romeoville, IL 60446-1091

Price is subject to change without notice.

CONVERSION CHART

Kilograms ↔ Pounds (1 Kg = 2.2 lbs)

kg	=	lbs	kg	=	lbs	kg	=	lbs
0.25	=	0.6	2.65	=	5.8	5.00	=	11.0
0.35	=	0.8	2.75	=	6.0	5.10	=	11.2
0.50	=	1.1	2.90	=	6.4	5.25	=	11.5
0.65	=	1.4	3.00	=	6.6	5.35	=	11.8
0.75	=	1.7	3.10	=	6.8	5.50	=	12.1
0.90	=	2.0	3.25	=	7.1	5.65	=	12.5
1.00	=	2.2	3.35	=	7.4	5.75	=	12.7
1.10	=	2.4	3.50	=	7.7	5.90	=	13.0
1.25	=	2.8	3.65	=	8.0	6.00	=	13.2
1.35	=	3.0	3.75	=	8.3	6.10	=	13.4
1.50	=	3.3	3.90	=	8.6	6.25	=	13.8
1.65	=	3.6	4.00	=	8.8	6.35	=	14.0
1.75	=	3.9	4.10	=	9.0	6.50	=	14.3
1.90	=	4.2	4.25	=	9.4	6.65	=	14.7
2.00	=	4.4	4.35	=	9.6	6.75	=	14.9
2.10	=	4.6	4.50	=	9.9	6.90	=	15.2
2.25	=	5.0	4.65	=	10.3	7.00	=	15.4
2.35	=	5.2	4.75	=	10.5	7.10	=	15.7
2.50	=	5.5	4.90	=	10.8	7.20	=	15.9

°F ↔ °C

°F	=	°C	°F	=	°C	°F	=	°C
100	=	40	160	=	71	250	=	120
110	=	43	165	=	74	275	=	135
120	=	49	170	=	77	300	=	150
130	=	54	175	=	79	325	=	165
135	=	57	180	=	82	350	=	175
140	=	60	185	=	85	375	=	190
145	=	63	190	=	88	400	=	205
150	=	65	200	=	93	425	=	220
155	=	68	225	=	107	450	=	230

SERVICE CALL CHECK

Please check the following before calling for service:

Place one cup of water in a glass measuring cup in the oven and close the door securely.
Operate the oven for one minute.

- A** Does the cooling fan work? YES _____ NO _____
(Put your hand over the rear ventilating openings.)
- B** Does the turntable rotate? YES _____ NO _____
(It is normal for the turntable to turn in either direction.)
- C** Is the water in the oven warm? YES _____ NO _____

If "NO" is the answer to any of the above questions, please check electrical outlet, fuse and/or circuit breaker. If they are functioning properly, CONTACT YOUR NEAREST SHARP AUTHORIZED SERVICER. A microwave oven should never be serviced by a "do-it-yourself" repair person.

AUTO-TOUCH® GUIDE

For more complete information and safety precautions, refer to your Operation Manual.

SET CLOCK

If [88:88] is in display, first touch the **STOP/CLEAR** pad. To set 12:35 for example:

- 1 Open the door and touch the **CLOCK** pad.

CLOCK
TIMER

- 2 Enter correct time of the day (hours) by touching the time pads.

10 MINUTES x 1 1 MINUTE x 2

- 3 Touch the **CLOCK** pad again.

CLOCK
TIMER

- 4 Enter the correct time of day (minutes) by touching the time pads.

10 MINUTES x 3 1 MINUTE x 5

- 5 Touch the **CLOCK** pad again.

CLOCK
TIMER

COMPUCOOK

- 1 Open the door and touch the **COMPUCOOK** pad until the desired CompuCook number is displayed. (Ex: Touch 3 times to reheat a roll.)

COMPU
COOK x 3

- 2 Close the door and touch the **START** pad.

START/MINUTEPLUS

DISPLAY	FOOD	AMOUNT	
			DOUBLE QUANTITY
CC-1	Pizza (Reheat)	1 slice	2 slices
CC-2	Coffee/Tea	1 cup	2 cups
CC-3	Rolls & Muffins	1 medium	2 medium
CC-4	Casserole	1 cup	2 cups
CC-5	Frozen Entree	3 - 6 oz. (90-170 g)	7 - 10 oz. (200 - 280 g)
CC-6	Baked Potatoes	1 medium	2 medium

DOUBLE
QUANTITY

Touch the **COMPUCOOK** pad until the desired choice shows on the display, touch the **DOUBLE QUANTITY** pad, close the door and touch the **START** pad.

MINUTE PLUS

Touch the **MINUTE PLUS** pad for one minute or to add a minute during manual cooking. Continue to touch for additional minutes.

START/MINUTEPLUS

MANUAL OPERATION

- 1 Open the door and enter cooking time by touching the time pads. (Ex: 1 min. 30 sec.)

1 MINUTE x 1 15 SECONDS x 2

- 2 Close the door and touch the **START** pad.

START/MINUTEPLUS

EXPRESS DEFROST

- 1 Open the door and enter the defrost time. (Ex: 14 min.)

10 MINUTES x 1 1 MINUTE x 4

- 2 Touch the **EXPRESS DEFROST** pad.

EXPRESS
DEFROST

- 3 Close the door and touch the **START** pad.

START/MINUTEPLUS

FOOD/AMOUNT	TIME(MIN/LB)
1. Steaks/chops (fish) .5 to 4.0 lb (0.3 - 1.8 kg) Less than 1" thick More than 1" thick	6 - 6½ 7 - 7½
2. Ground meat .5-1.0 lb (0.3 - 0.5 kg) 1.1-3.0 lb (0.6 - 1.3 kg)	6 - 6½ 6½ - 7
3. Chicken pieces .5-3.0 lb (0.3 - 1.3 kg)	5½ - 6

POPCORN

- 1 Open the door and touch the **POPCORN** pad once for a regular size.

POPCORN

Twice - light regular size
3 times - snack size
4 times - light snack size

- 2 Close the door and touch the **START** pad.

START/MINUTEPLUS

FOOD	AMOUNT
Popcorn	3.5 oz. (100 g) 3.0 or 3.5 oz. (90 - 100 g) (Light) 1.75 oz. (50 g) 1.5 or 1.75 oz. (45 - 50 g) (Light)

Carousel® and Auto-touch® are registered trademarks of Sharp Corporation.

SHARP®