

over the range models >

R-1750 / R-1751 / R-1752 / R-1754

microwave
cooking
guide

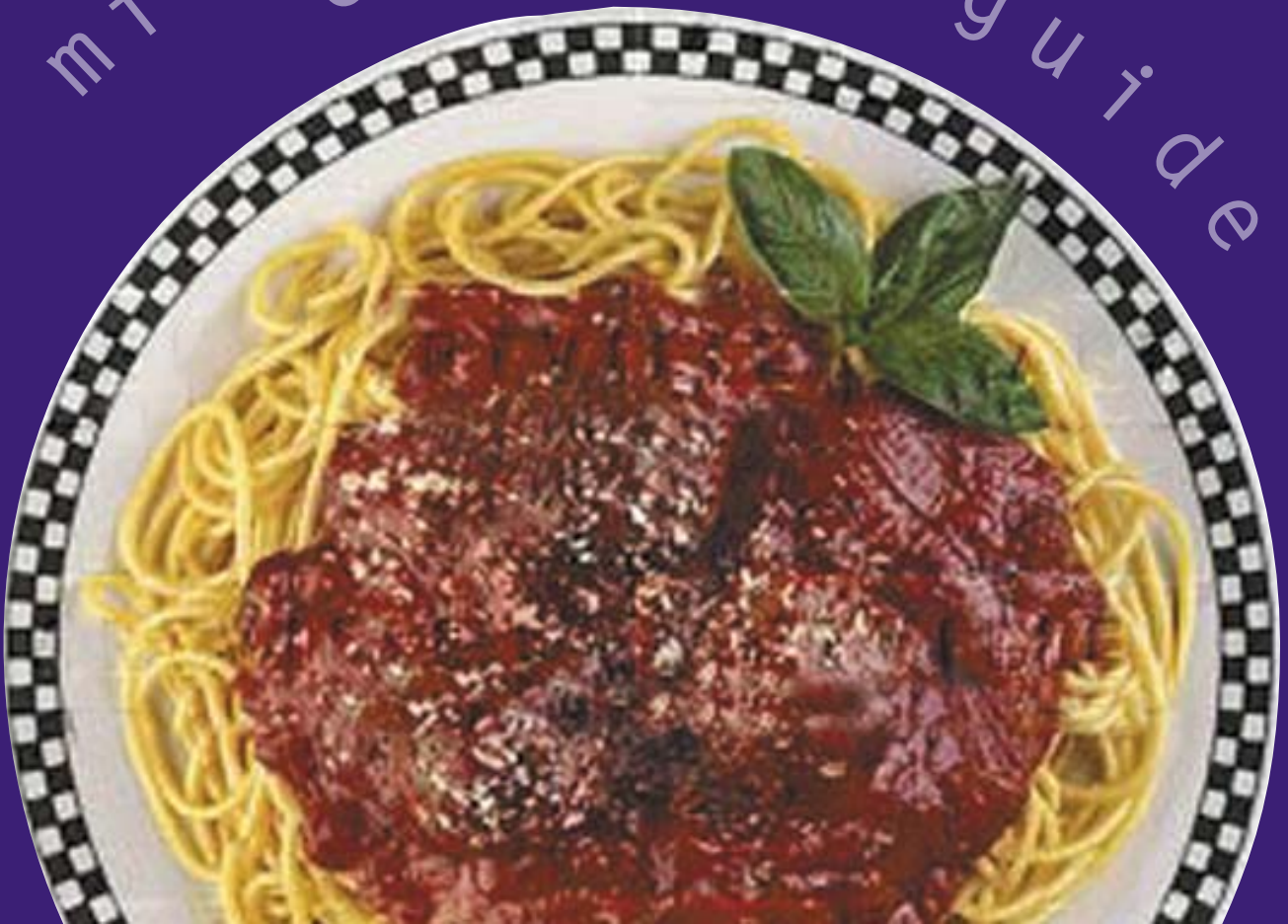

FOR CUSTOMER ASSISTANCE

To aid in reporting this microwave oven in case of loss or theft, please record below the model number and serial number located on the unit. We also suggest you record all the information listed and retain for future reference.

MODEL NUMBER _____	SERIAL NUMBER _____
DATE OF PURCHASE _____	
DEALER _____	TELEPHONE _____
SERVICER _____	TELEPHONE _____

TO PHONE :

DIAL 1-800-BE-SHARP (237-4277) for :

SERVICE (for your nearest Sharp Authorized Servicer)

PARTS (for your authorized parts distributor)

ADDITIONAL CUSTOMER INFORMATION

DIAL 1-800-642-2122 for :

ACCESSORIES and COOKBOOK

TO WRITE :

Sharp Electronics Corporation
Customer Assistance Center
1300 Naperville Drive
Romeoville, IL 60446-1091

Please provide the following information when you write or call: model number, serial number, date of purchase, your complete mailing address (including zip code), your daytime telephone number (including area code) and description of the problem.

TO ACCESS INTERNET : www.sharp-usa.com

PRECAUTIONS TO AVOID POSSIBLE EXPOSURE TO EXCESSIVE MICROWAVE ENERGY

- (a) Do not attempt to operate this oven with the door open since open-door operation can result in harmful exposure to microwave energy. It is important not to defeat or tamper with the safety interlocks.
- (b) Do not place any object between the oven front face and the door or allow soil or cleaner residue to accumulate on sealing surfaces.
- (c) Do not operate the oven if it is damaged. It is particularly important that the oven door close properly and that there is no damage to the: (1) door (bent), (2) hinges and latches (broken or loosened), (3) door seals and sealing surfaces.
- (d) The oven should not be adjusted or repaired by anyone except properly qualified service personnel.

CONTENTS

- 2 For Customer Assistance**
- 2 Precautions to Avoid Possible Exposure to Excessive Microwave Energy**
- 3 Contents**
- 4 Consumer Limited Warranty**
- 4 Product Information Card**
- 5 Important Safety Instructions**
- 6 Unpacking Instructions**
- 6 Optional Accessories**
- 6 Grounding Instructions**
- 7-9 Information You Need to Know**
 - 7 About Your Oven
 - 7 About Food
 - 8 About Utensils and Coverings
 - 8 About Children and the Microwave
 - 9 About Microwave Cooking
 - 9 About Safety
- 9-10 Part Names**
- 11-12 Introduction to Touch Screen**
- 12-14 Before Operating**
 - 13 To Set The Clock
 - 14 Stop/Clear
- 14-16 Manual Operation**
 - 14 High Power Cooking
 - 15 Variable Power Cooking
 - 15 Multiple Sequence Cooking
 - 16 Manual Defrost
- 16-17 One Touch Sensor**
 - 17 Reheat / Popcorn / Baked Potatoes
 - 17 One Touch Sensor Cooking Chart
- 18-19 6x6 No Guess Cooking**
 - 18 Vegetables
 - 18 Meats-Poultry-Fish/Seafood-Frozen Foods-Pasta/Grains
 - 19 6x6 No Guess Cooking Chart
- 20-25 More From Your Microwave 6x6**
 - 20 Breakfast Bar / Lunch On The Run
 - 20 Breakfast Bar / Lunch On The Run Chart
 - 21 One Dish Dinners-Low Calorie Entrees
Supper Soups And Sauces-
Delicious Desserts
 - 22 Recipes for One Dish Dinners
 - 23 Recipes for Low Calorie Entrees
 - 24 Recipes for Supper Soups And Sauces
 - 25 Recipes for Delicious Desserts
- 26-28 Defrost 3+6**
 - 26 Super Defrost
 - 26 Super Defrost Chart
 - 27 CompuDefrost
 - 27 CompuDefrost Chart
- 28 Beverage Center**
- 28 Keep Warm**
- 29 Fan Options**
- 29 Light Options**
- 30 Turntable On/Off**
- 31-32 Set Up**
 - 31 1. Clock
 - 31 2. Auto Start
 - 32 3. Sound Adjustment
 - 32 4. Child Lock
 - 32 5. Video Demo
 - 32 6. Screen Contrast
- 32-34 Other Convenient Features**
 - 32 Minute Plus
 - 33 Minute Plus+
 - 33 Kitchen Timer
 - 34 More or Less Time Adjustment
- 35 Cleaning and Care**
- 36 Replacing Parts**
 - 36 Oven Light
 - 36 Work Light and Night Light
 - 36 Charcoal Filter
- 37 Specifications**
- 37 THE ULTIMATE ACCESSORY**
- 38 COOKBOOK ORDER FORM**
- 38 Service Call Check**
- 39-40 Quick Reference**
 - 39 One Touch Sensor
 - 39 6x6 No Guess Cooking
 - 39 More From Your Microwave 6x6
 - 39 Beverage Center
 - 39 Defrost 3+6
 - 39 Set Up
 - 40 Auto-Touch Guide

CONSUMER LIMITED WARRANTY

SHARP ELECTRONICS CORPORATION warrants to the first consumer purchaser that this Sharp brand product (the "Product"), when shipped in its original container, will be free from defective workmanship and materials, and agrees that it will, at its option, either repair the defect or replace the defective Product or part thereof with a new or remanufactured equivalent at no charge to the purchaser for parts or labor for the period(s) set forth below.

This warranty does not apply to any appearance items of the Product nor to the additional excluded item(s) set forth below nor to any Product the exterior of which has been damaged or defaced, which has been subjected to misuse, abnormal service or handling, or which has been altered or modified in design or construction.

In order to enforce the rights under this limited warranty, the purchaser should follow the steps set forth below and provide proof of purchase to the servicer.

The limited warranty described herein is in addition to whatever implied warranties may be granted to purchasers by law. ALL IMPLIED WARRANTIES INCLUDING THE WARRANTIES OF MERCHANTABILITY AND FITNESS FOR USE ARE LIMITED TO THE PERIOD(S) FROM THE DATE OF PURCHASE SET FORTH BELOW. Some states do not allow limitations on how long an implied warranty lasts, so the above limitation may not apply to you.

Neither the sales personnel of the seller nor any other person is authorized to make any warranties other than those described herein, or to extend the duration of any warranties beyond the time period described above on behalf of Sharp.

The warranties described herein shall be the sole and exclusive warranties granted by Sharp and shall be the sole and exclusive remedy available to the purchaser. Correction of defects, in the manner and for the period of time described herein, shall constitute complete fulfillment of all liabilities and responsibilities of Sharp to the purchaser with respect to the Product, and shall constitute full satisfaction of all claims, whether based on contract, negligence, strict liability or otherwise. In no event shall Sharp be liable, or in any way responsible, for any damages or defects in the Product which were caused by repairs or attempted repairs performed by anyone other than an authorized servicer. Nor shall Sharp be liable or in any way responsible for any incidental or consequential economic or property damage. Some states do not allow the exclusion of incidental or consequential damages, so the above exclusion may not apply to you.

THIS WARRANTY GIVES YOU SPECIFIC LEGAL RIGHTS. YOU MAY ALSO HAVE OTHER RIGHTS WHICH VARY FROM STATE TO STATE.

Your Product Model Number & Description:

R-1750, R-1751, R-1752 and R-1754 Home Use Carousel™ Microwave Oven. (Be sure to have this information available when you need service for your Product.)

Warranty Period for this Product:

One (1) year parts and labor in-home service. The warranty period continues for an additional six (6) years, for a total of seven (7) years, with respect to the magnetron tube in the Product for parts only. Labor and the servicer trip charge are not provided free of charge for this additional period.

Additional Item(s) Excluded from Warranty Coverage (if any):

Non-functional accessories, turntable and light bulbs.

Where to Obtain Service:

From a Sharp Authorized Servicer located In the United States. Be sure to have **Proof of Purchase** available. For in-home service, the servicer will come to the unit's location. If it is necessary to remove the unit for repair, the servicer will reinstall the unit at no extra charge, provided it was installed according to Sharp's Installation Instructions. To find the location of the nearest Sharp Authorized Servicer, call Sharp toll free at 1-800-BE-SHARP (1-800-237-4277).

TO OBTAIN SUPPLY, ACCESSORY OR PRODUCT INFORMATION,
CALL **1-800-BE-SHARP** OR VISIT www.sharp-usa.com.

SAVE THE PROOF OF PURCHASE AS IT IS NEEDED SHOULD YOUR OVEN EVER REQUIRE WARRANTY SERVICE.

PRODUCT INFORMATION CARD

The product information card should be completed within ten days of purchase and returned. We will keep it on file and help you access the information in case of loss, damage or theft. This will also enable us to contact you in the unlikely event that any adjustments or modifications are ever required for your oven.

IMPORTANT SAFETY INSTRUCTIONS

When using electrical appliances, basic safety precautions should be followed, including the following:

WARNING - To reduce the risk of burns, electric shock, fire, injury to persons or exposure to excessive microwave energy:

1. **Read all instructions before using the appliance.**
2. Read and follow the specific **“PRECAUTIONS TO AVOID POSSIBLE EXPOSURE TO EXCESSIVE MICROWAVE ENERGY”** on page 2.
3. This appliance must be grounded. Connect only to properly grounded outlet. See **“GROUNDING INSTRUCTIONS”** on page 6 and **INSTALLATION INSTRUCTIONS**.
4. Install or locate this appliance only in accordance with the provided installation instructions.
5. Some products such as whole eggs and sealed containers — for example, closed glass jars — may explode and should not be heated in this oven.
6. Use this appliance only for its intended use as described in this manual. Do not use corrosive chemicals or vapors in this appliance. This type of oven is specifically designed to heat, cook or dry food. It is not designed for industrial or laboratory use.
7. As with any appliance, close supervision is necessary when used by children.
8. Do not operate this appliance if it has a damaged cord or plug, if it is not working properly or if it has been damaged or dropped.
9. This appliance should be serviced only by qualified service personnel. Contact nearest Sharp Authorized Servicer for examination, repair or adjustment.
10. Do not cover or block any openings on the appliance.
11. Do not store or use this appliance outdoors. Do not use this product near water—for example, near a kitchen sink, in a wet basement or near a swimming pool, and the like.
12. Do not immerse cord or plug in water.
13. Keep cord away from heated surfaces.
14. Do not let cord hang over edge of table or counter.
15. See door surface cleaning instructions on page 35.
16. To reduce the risk of fire in the oven cavity:
 - a. Do not overcook food. Carefully attend appliance if paper, plastic or other combustible materials are placed inside the oven to facilitate cooking.
 - b. Remove wire twist-ties from paper or plastic bags before placing bag in oven.
 - c. If materials inside the oven should ignite, keep oven door closed, turn oven off, and disconnect the power cord or shut off power at the fuse or circuit breaker panel.**
 - d. Do not use the cavity for storage purposes. Do not leave paper products, cooking utensils or food in the cavity when not in use.
17. Clean ventilation openings and grease filters frequently—Grease should not be allowed to accumulate on ventilation openings, hood (louver) or grease filters.
18. Use care when cleaning the louver and the grease filters. Corrosive cleaning agents, such as lye-based oven cleaners, may damage the louver and the grease filters.
19. When flaming foods under the hood, turn the fan on.
20. This appliance is suitable for use above both gas and electric cooking equipment 36" wide or less.

SAVE THESE INSTRUCTIONS

UNPACKING INSTRUCTIONS

Unpacking and Examining Your Oven

Open the bottom of the carton, bend the carton flaps back and tilt the oven over to rest on plastic foam pad. Lift carton off oven and remove all packing materials, Installation Instructions, Wall Template, Top Template, Charcoal Filter, Turntable and Turntable Support. **SAVE THE CARTON AS IT MAY MAKE INSTALLATION EASIER.**

1. Remove the feature sticker from the outside of the door, if there is one.
2. **DO NOT REMOVE THE WAVEGUIDE COVER**, which is located on the ceiling in the oven cavity. Check to see that there are Installation Instructions, Wall Template, Top Template and RK-230 Charcoal Filter, which is used when recirculating is chosen. Read enclosures and **SAVE** the Operation Manual.

Check the oven for any damage, such as misaligned or bent door, damaged door seals and sealing surfaces, broken or loose door hinges and latches and dents inside the cavity or on the door. If there is any damage, do not operate the oven and contact your dealer or SHARP AUTHORIZED SERVICER. See Installation Instructions for more details.

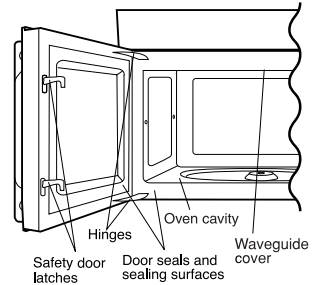

OPTIONAL ACCESSORIES

Two optional accessories are available for this oven.

1. Charcoal Filter (RK-230). The filter packed in the oven is required when hood exhaust is recirculated. See Charcoal Filter on page 36. To purchase a replacement Charcoal Filter, check with the dealer or call 1-800-642-2122. Have credit card ready.
2. Filler Panel Kit. For use when the oven is installed in a 36-inch or 42-inch wide opening. The metal filler panels come in 3-inch wide pairs. One set is needed for a 36-inch opening and 2 sets for a 42-inch opening. White and black are available.

To purchase contact: Modern-Aire Ventilating Corporation
7319 Lankershim Blvd.
North Hollywood, CA 91605
Phone: (818) 765-9870 Fax: (818) 765-4916

GROUNDING INSTRUCTIONS

This appliance must be grounded. This oven is equipped with a cord having a grounding wire with a grounding plug. It must be plugged into a wall receptacle that is properly installed and grounded in accordance with the National Electrical Code and local codes and ordinances. In the event of an electrical short circuit, grounding reduces risk of electric shock by providing an escape wire for the electric current.

WARNING – Improper use of the grounding plug can result in a risk of electric shock.

Electrical Requirements

Check Installation Instructions for proper location for the power supply.

The electrical requirements are a 120 volt 60 Hz, AC only, 15 amp. or more protected electrical supply. It is recommended that a separate circuit serving only the oven be provided.

The oven is equipped with a 3-prong grounding plug. It must be plugged into a wall receptacle that is properly installed and grounded. **DO NOT UNDER ANY CIRCUMSTANCES CUT OR REMOVE THE GROUNDING PIN FROM THE PLUG.**

- Notes:**
1. If you have any questions about the grounding or electrical instructions, consult a qualified electrician or service person.
 2. Neither Sharp nor the dealer can accept any liability for damage to the oven or personal injury resulting from failure to observe the correct electrical connection procedures.

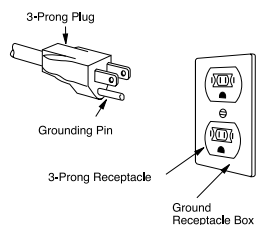

Radio or TV Interference

Should there be any interference caused by the microwave oven to your radio or TV, check that the microwave oven is on a different electrical circuit, relocate the radio or TV as far away from the oven as feasible or check position and signal of receiving antenna.

INFORMATION YOU NEED TO KNOW

ABOUT YOUR OVEN

This Operation Manual is valuable: read it carefully and always save it for reference.

A good microwave cookbook is a valuable asset. Check it for microwave cooking principles, techniques, hints and recipes. See pages 37 and 38 for ordering the Ultimate Accessory, the SHARP CAROUSEL MICROWAVE COOKBOOK.

NEVER use the oven without the turntable and support nor turn the turntable over so that a large dish could be placed in the oven. The turntable will turn both clockwise and counterclockwise. See page 30 for complete instructions.

ALWAYS have food in the oven when it is on to absorb the microwave energy.

When using the oven at power levels below 100%, you may hear the magnetron cycling on and off.

Condensation is a normal part of microwave cooking. Room humidity and the moisture in food will influence the amount of moisture that condenses in the oven. Generally, covered foods will not cause as much condensation as uncovered ones. Vents on the oven back must not be blocked.

The oven is for food preparation only. It should not be used to dry clothes or newspapers.

Your oven is rated 1100 watts by using the IEC Test Procedure. In using recipes or package directions, check food a minute or two before the minimum time and add time accordingly.

ABOUT FOOD

FOOD	DO	DON'T
Eggs, sausages, nuts, seeds, fruits & vegetables	<ul style="list-style-type: none"> • Puncture egg yolks before cooking to prevent "explosion". • Pierce skins of potatoes, apples, squash, hot dogs and sausages so that steam escapes. 	<ul style="list-style-type: none"> • Cook eggs in shells. • Reheat whole eggs. • Dry nuts or seeds in shells.
Popcorn	<ul style="list-style-type: none"> • Use specially bagged popcorn for the microwave oven. • Listen while popping corn for the popping to slow to 1 or 2 seconds or use special Popcorn pad. 	<ul style="list-style-type: none"> • Pop popcorn in regular brown bags or glass bowls. • Exceed maximum time on popcorn package.
Baby food	<ul style="list-style-type: none"> • Transfer baby food to small dish and heat carefully, stirring often. Check temperature before serving. • Put nipples on bottles after heating and shake thoroughly. "Wrist" test before feeding. 	<ul style="list-style-type: none"> • Heat baby food in original jars. • Heat disposable bottles. • Heat bottles with nipples on.
General	<ul style="list-style-type: none"> • Cut baked goods with filling after heating to release steam and avoid burns. • Stir liquids briskly before and after heating to avoid "eruption". • Use deep bowl, when cooking liquids or cereals, to prevent boilovers. 	<ul style="list-style-type: none"> • Heat or cook in closed glass jars or air tight containers. • Can in the microwave as harmful bacteria may not be destroyed. • Deep fat fry. • Dry wood, gourds, herbs or wet papers. • Operate the oven empty.

INFORMATION YOU NEED TO KNOW

ABOUT UTENSILS AND COVERINGS

It is not necessary to buy all new cookware. Many pieces already in your kitchen can be used successfully in your new microwave oven.

Use these utensils for safe microwave cooking and reheating:

- glass ceramic (Pyroceram®), such as Corningware®.
- heat-resistant glass (Pyrex®)
- microwave-safe plastics (some microwave-safe plastics are not suitable for cooking foods with high fat and sugar content.)
- paper plates
- microwave-safe pottery, stoneware and porcelain
- browning dish (Do not exceed recommended preheating time. Follow manufacturer's directions.)

These items can be used for short time reheating of foods that have little fat or sugar in them:

- wood, straw, wicker

DO NOT USE

- metal pans and bakeware
- dishes with metallic trim
- non-heat-resistant glass
- non-microwave-safe plastics (margarine tubs)
- recycled paper products
- brown paper bags
- food storage bags
- metal twist-ties

Should you wish to check if a dish is safe for microwaving, place the empty dish in the oven and microwave on 100% power for 30 seconds. A dish which becomes very hot should not be used.

ABOUT CHILDREN AND THE MICROWAVE

Children below the age of 7 should use the microwave oven with a supervising person very near to them. Between the ages of 7 and 12, the supervising person should be in the same room.

The child must be able to reach the oven comfortably; if not, he/she should stand on a sturdy stool.

At no time should anyone be allowed to lean or swing on the oven door.

The following coverings are ideal:

- Paper towels are good for covering foods for reheating and absorbing fat while cooking bacon.
- Wax paper can be used for cooking and reheating.
- Plastic wrap that is specially marked for microwave use can be used for cooking and reheating. **DO NOT** allow plastic wrap to touch food. Vent so steam can escape.
- Lids that are microwave-safe are a good choice because heat is kept near the food to hasten cooking.
- Oven cooking bags are good for large meats or foods that need tenderizing. **DO NOT** use metal twist ties. Remember to slit bag so steam can escape.

How to use aluminum foil in your microwave oven:

- Small flat pieces of aluminum foil placed smoothly on the food can be used to shield areas that are either defrosting or cooking too quickly.
- Foil should not come closer than one inch to any surface of the oven.

Should you have questions about utensils or coverings, check a good microwave cookbook or follow recipe suggestions.

ACCESSORIES There are many microwave accessories available for purchase. Evaluate carefully before you purchase so that they meet your needs. A microwave-safe thermometer will assist you in determining correct doneness and assure you that foods have been cooked to safe temperatures. Sharp is not responsible for any damage to the oven when accessories are used.

Children should be taught all safety precautions: use potholders, remove coverings carefully, pay special attention to packages that crisp food because they may be extra hot.

Don't assume that because a child has mastered one cooking skill he/she can cook everything.

Children need to learn that the microwave oven is not a toy. See page 32 for Child Lock feature.

INFORMATION YOU NEED TO KNOW

ABOUT MICROWAVE COOKING

- Arrange food carefully. Place thickest areas toward outside of dish.
- Watch cooking time. Cook for the shortest amount of time indicated and add more as needed. Foods severely overcooked can smoke or ignite.
- Cover foods while cooking. Check recipe or cook-book for suggestions: paper towels, wax paper, microwave plastic wrap or a lid. Covers prevent spattering and help foods to cook evenly.
- Shield with small flat pieces of aluminum foil any thin areas of meats or poultry to prevent overcooking before dense, thick areas are cooked thoroughly.
- Stir foods from outside to center of dish once or twice during cooking, if possible.
- Turn foods over once during microwaving to speed cooking of such foods as chicken and hamburgers. Large items like roasts must be turned over at least once.
- Rearrange foods like meatballs halfway through cooking both from top to bottom and from the center of the dish to the outside.
- Add standing time. Remove food from oven and stir, if possible. Cover for standing time which allows the food to finish cooking without overcooking.
- Check for doneness. Look for signs indicating that cooking temperatures have been reached.

Doneness signs include:

- Food steams throughout, not just at edge.
- Center bottom of dish is very hot to the touch.
- Poultry thigh joints move easily.
- Meats and poultry show no pinkness.
- Fish is opaque and flakes easily with a fork.

ABOUT SAFETY

- Check foods to see that they are cooked to the United States Department of Agriculture’s recommended temperatures:
- Always use potholders to prevent burns when handling utensils that are in contact with hot food. Enough heat from the food can transfer through utensils to cause skin burns.
- Avoid steam burns by directing steam away from the face and hands. Slowly lift the farthest edge of a dish’s covering and carefully open popcorn and oven cooking bags away from the face.
- Stay near the oven while it’s in use and check cooking progress frequently so that there is no chance of overcooking food.
- NEVER use the cavity for storing cookbooks or other items.
- Select, store and handle food carefully to preserve its high quality and minimize the spread of foodborne bacteria.
- Keep waveguide cover clean. Food residue can cause arcing and/or fires.
- Use care when removing items from the oven so that the utensil, your clothes or accessories do not touch the safety door latches.

TEMP	FOOD
160°F	... for fresh pork, ground meat, boneless white poultry, fish, seafood, egg dishes and frozen prepared food.
165°F	... for leftover, ready-to-reheat refrigerated, and deli and carry-out “fresh” food.
170°F	... white meat of poultry.
180°F	... dark meat of poultry.

To test for doneness, insert a meat thermometer in a thick or dense area away from fat or bone. NEVER leave the thermometer in food during cooking, unless it is approved for microwave oven use.

PART NAMES

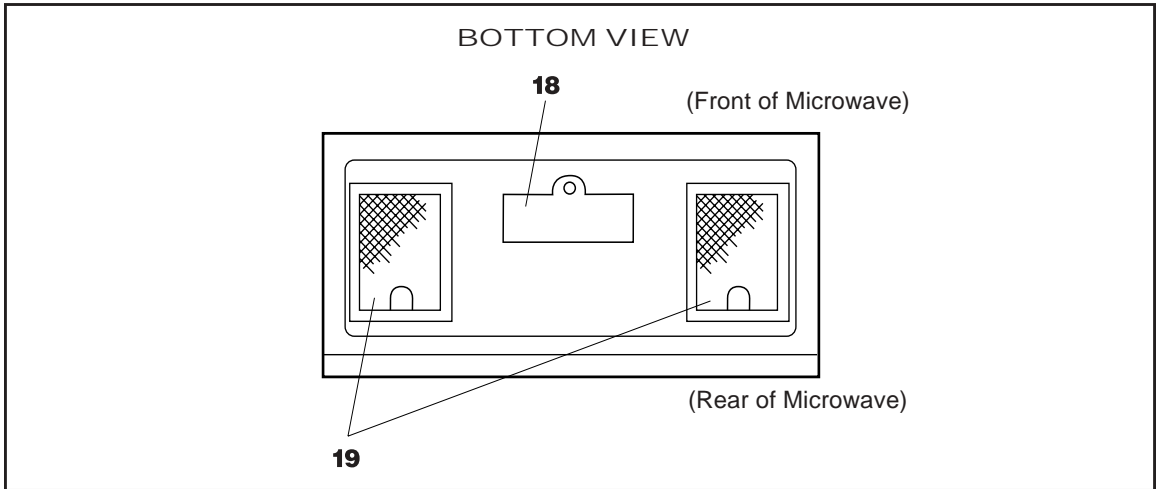
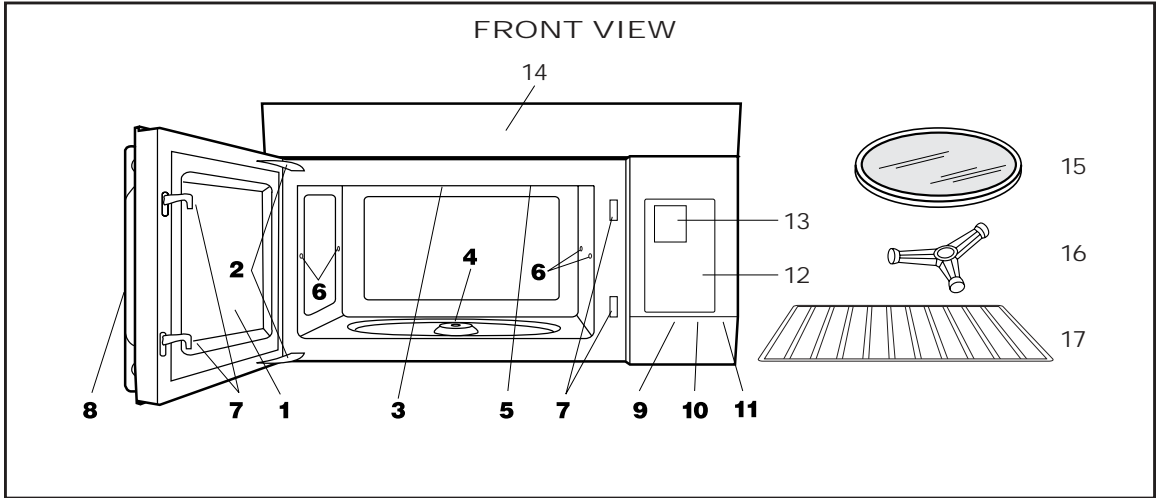

- | | |
|--|---|
| 1 Oven door with see-through window | 11 Turntable On/Off pad. |
| 2 Door hinges | 12 Auto-Touch control panel |
| 3 Waveguide cover:
DO NOT REMOVE. | 13 Smart & Easy Touch Screen |
| 4 Turntable motor shaft | 14 Ventilation openings |
| 5 Oven light
It will light when oven is operating or door is open. | 15 Removable turntable
The turntable will rotate clockwise or counterclockwise. Only remove for cleaning. |
| 6 Rack holders | 16 Removable turntable support
First, carefully place the turntable support in the motor shaft in the center of the oven floor. Then, place the turntable on the turntable support securely. |
| 7 Safety door latches
The oven will not operate unless the door is securely closed. | 17 Rack for 2-level cooking/reheating |
| 8 Handle | 18 Light cover |
| 9 Fan Options pad | 19 Grease filters |
| 10 Light Options pad | |

TOUCH SCREEN CONTROL PANEL

SMART & EASY TOUCH SCREEN : 12-13

The Home Page is for entering time for cooking or kitchen timer. The TOUCH SCREEN shows cooking information and recipes and lets the user enter chosen options by simply touching directly on the screen.

Minute Plus+ : 33

Touch to access screen where 12 common cooking times are shown that simply require one touch to start.

STOP/CLEAR : 14

During programming, press once to return to the Home Page. During cooking, press once to stop cooking or twice to cancel the cooking program.

MINUTE PLUS : 32

Press once to cook for one minute at 100% or press repeatedly to extend cooking time in multiples of one minute.

START

Press to start oven after programming.

6x6 NO GUESS COOKING : 18-19

Press each pad to show six selections on the TOUCH SCREEN.

FAN OPTIONS : 29

Press pad to show 3 selections.

LIGHT OPTIONS : 29

Press pad to show 3 selections.

TURNTABLE ON/OFF : 30

Press to turn turntable off. The icon will appear on the display.

ONE TOUCH SENSOR

Reheat

Popcorn

Baked Potatoes

Beverage Center

Keep Warm

Defrost 3+6

MORE FROM YOUR MICROWAVE 6x6

Set Up

ONE TOUCH SENSOR : 16-17

Select pad to bake potatoes, pop popcorn or reheat previously prepared foods.

Kitchen Timer : 33

Touch Kitchen Timer, enter desired time and press START.

BEVERAGE CENTER : 28

Press to prepare or reheat coffee or tea.

KEEP WARM: 28

Press to warm food up to 30 minutes.

DEFROST 3+6 : 26-27

Press to select one of three SuperDefrost or one of six CompuDefrost options.

MORE FROM YOUR MICROWAVE 6x6 : 20-25

Press pad to show six categories, each with six foods. Breakfast Bar, Lunch on the Run, One Dish Dinners, Low Calorie Entrees, Supper Soups and Sauces and Delicious Desserts are the options.



Number next to the control panel illustration indicates page on which there are feature descriptions and usage information.

INTRODUCTION TO TOUCH SCREEN

Your new Sharp Smart & Easy Touch Screen Microwave Oven features a large screen on the Control Panel which, not only provides much information to make using the oven easy, but also, is used to input information directly about the food being cooked, quantity or desired doneness.

Example 1: Home Page



The Home Page is the beginning. It shows the time of day, if the clock has been set. It also shows Minute Plus+, where by touching the screen the next screen appears, making it easy to select one of twelve commonly used times. Touching Kitchen Timer tells the oven that the time set is only for timing, not for cooking.

Note that if cooking time is touched on the screen, that Minute Plus+ and Kitchen Timer disappear and Power Level appears. Touching Power Level leads to the next screen for selecting the desired Power Level.

Example 2: Suppose you want to cook meat loaf in 6x6 NO GUESS COOKING:

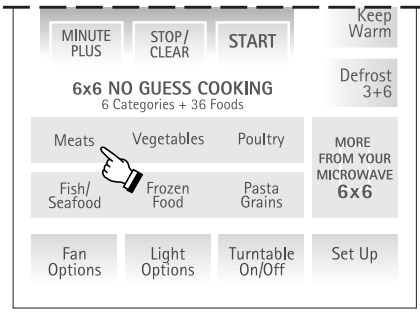

1 Press Meats on the Control Panel in 6x6 NO GUESS COOKING.



2 Note that six meat selections appear on the TOUCH SCREEN. Touch Meat Loaf.



3 Follow directions on the TOUCH SCREEN.

Example 3: Suppose you want to cook Spicy Couscous in More From Your Microwave 6x6:

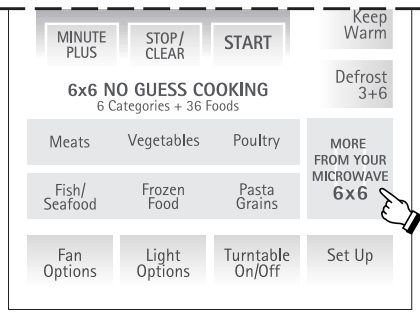

1 Press MORE FROM YOUR MICROWAVE 6x6 on the Control Panel.



2 Touch One Dish Dinners on the TOUCH SCREEN.

INTRODUCTION TO TOUCH SCREEN



3 Touch Spicy Couscous.

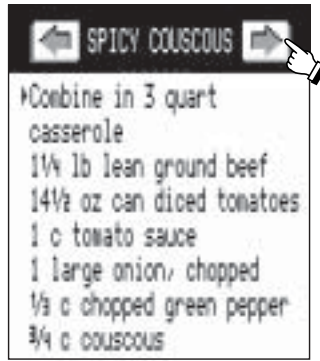

4 Note Preparation steps. Note arrows*.

* Forward  and Back  Arrows:

On all recipe screens and some preparation screens, there will be forward and back arrows, located in the upper corners of the TOUCH SCREEN. Touch to read the entire recipe before beginning any cooking.

BEFORE OPERATING

Before operating your new SMART & EASY TOUCH SCREEN microwave oven, be sure to read and understand this operation manual.

Before the oven can be used, follow the steps:

1. Plug in the oven. Close the door. You can select either: Video Demo or Set Clock.
2. Touch Set Clock and follow the instructions below.

NOTE:

If no choice is made for 30 seconds, the Video Demo will begin automatically. To cancel the Video Demo, press the STOP/CLEAR pad and the display will return to the Home Page. To set the clock, press the Set Up pad, touch Clock and follow the directions on the Touch Screen.

TO SET THE CLOCK

- Suppose you want to enter the correct time of day: 12:30 PM.

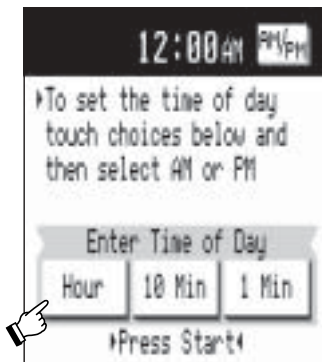

1 After touching Set Clock, enter the time of day (hour) by touching Hour 11 times.

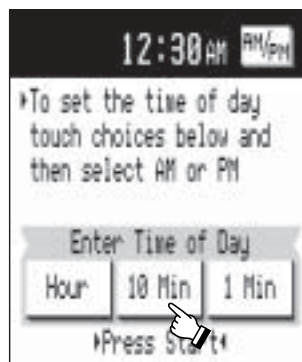

2 Enter the time of day (minutes) by touching 10 Min. 3 times.

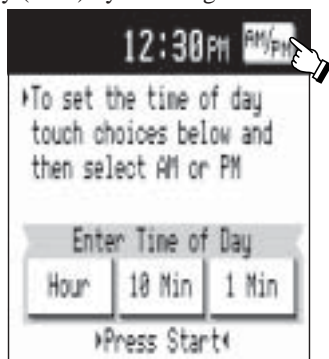

3 Select AM or PM and then press the START pad.



4 The clock will start. The display will return to the Home Page.

BEFORE OPERATING

NOTE :

1. If you make a mistake while setting the clock, touch STOP/CLEAR pad. The Home Page will appear. To set clock again, press Set Up pad on the control panel and Clock. Keep touching the screen until the desired time of day appears.
2. If you want to change the setting of the time of day, press Set Up pad and follow the directions.
3. If the electrical power supply to your microwave oven should be interrupted, the screen will intermittently show Video Demo or Set Clock after the power is reinstated. If this occurs during cooking, the program will be erased. Simply touch Set Clock and follow the directions.
4. If you touch continuously the Hour, 10 Min or 1 Min on the Touch Screen, the time will count up automatically.

STOP/CLEAR

Touch the STOP/CLEAR pad to:

1. Return the Home Page to the display, if you make a mistake during programming.
2. Stop the oven temporarily during cooking.
3. Cancel Kitchen Timer/Auto Start.
4. Cancel a program during cooking, touch twice.

MANUAL OPERATION

TIME COOKING

Your oven can be programmed for 99 minutes and 99 seconds (99.99). Always enter the seconds after the minutes, even if they are both zeros.

HIGH POWER COOKING

- Suppose you want to cook for five minutes at 100% power:

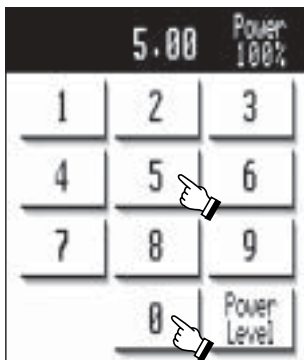

- 1 Enter cooking time, 5, 0, 0 by touching numbers. Note the top line of the display. Press the START pad.

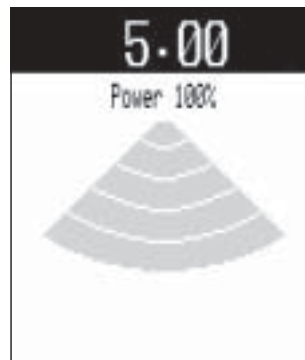

- 2 The display will begin counting down the cooking time. During the cooking, the power level will appear in the display.

NOTE:

If the door is opened or STOP/CLEAR pad is pressed once during cooking process, the cooking time in the display automatically stops. The cooking time starts

to count down again when the door is closed and the START pad is pressed.

MANUAL OPERATION

VARIABLE POWER COOKING

There are eleven preset power levels. To change the power level, touch Power Level after entering the cooking time. Using lower power levels increases the cooking time which is recommended for foods such as cheese, milk and long slow cooking of meats. Consult cookbook or recipes for specific recommendations.

- Suppose you want to cook for 5 minutes at 30% power:

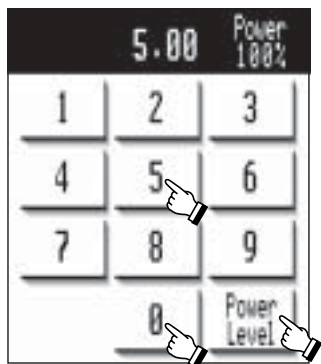

1 Enter cooking time, 5, 0, 0 by touching numbers. Touch Power Level.

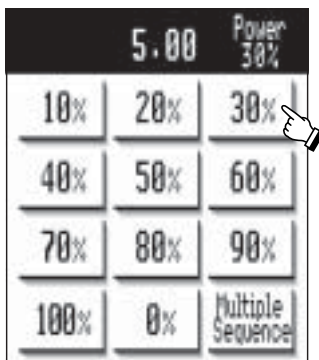

2 Touch 30%. The top line of the display will show time and chosen power level. Press START pad.

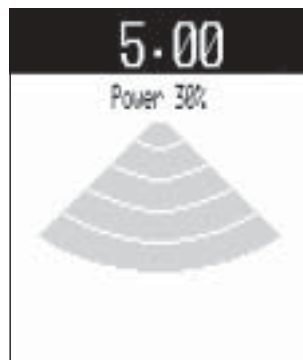

3 The display will begin counting down the cooking time. During the cooking, the power level will appear in the display.

MULTIPLE SEQUENCE COOKING

The oven can be programmed for up to four automatic cooking sequences, switching from one power level setting to another automatically. Sometimes cooking directions tell you to start on one power level and then change to a different power level. Your oven can do this automatically.

- Suppose you want to cook roast beef for 5 minutes at 70% power and then continue to cook for 30 minutes at 50% power:

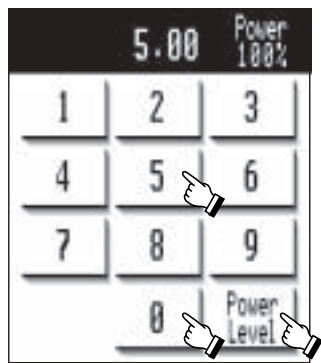

1 Enter cooking time, 5, 0, 0 by touching numbers. Touch Power Level.

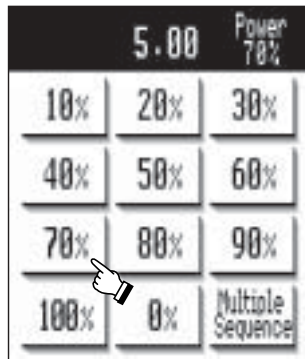

2 Touch 70%. You can omit this step when you set 100% power.

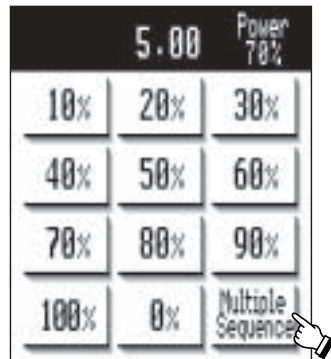

3 Touch Multiple Sequence.

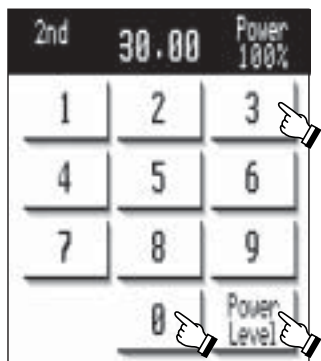

4 Touch second cooking time 3, 0, 0, 0. Touch Power Level.

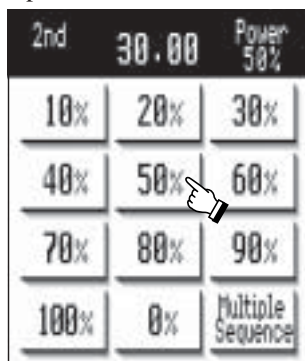

5 Touch 50%. Then press the START pad.

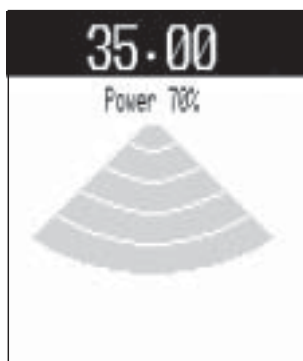

6 The display will begin counting down the total cooking time. During the cooking, the power level will appear in the display.

MANUAL OPERATION

MANUAL DEFROST

If the food that you wish to defrost is not listed on the COMPU DEFROST or SUPER DEFROST CHARTS or is above or below the limits in the AMOUNT column on the COMPU DEFROST or SUPER DEFROST CHARTS, you need to defrost manually.

You can defrost any frozen food, either raw or previously cooked, by using 30% power. Follow the exact procedure found on page 15. Estimate defrosting time, enter it. Then touch Power Level on the Touch Screen and select 30%.

For either raw or previously cooked frozen food the

rule of thumb is approximately four minutes per pound. For example, defrost four minutes for one pound of frozen spaghetti sauce.

Always stop the oven periodically to remove or separate the portions that are defrosted. If food is not defrosted at the end of the estimated defrosting time, program the oven in one minute increments on 30% power until totally defrosted.

When using plastic containers from the freezer, defrost only long enough to remove from the plastic in order to place in a microwave-safe dish.

ONE TOUCH SENSOR

Sharp's Sensor is a semi-conductor device that detects the vapor (moisture and humidity) emitted from the food as it heats. The sensor adjusts the cooking times and power level for various foods and quantities.

Using Sensor Settings

1. After oven is plugged in, wait two minutes before using any Sensor setting.
2. Be sure the exterior of the cooking container and the interior of the oven are dry. Wipe off any moisture with a dry cloth or paper towel.
3. The oven works with foods at normal storage temperature. For example, popcorn would be at room temperature.
4. Any Sensor Cooking or Reheating selection can be programmed with More or Less Time Adjustment. See page 34.
5. More or less food than the quantity listed in the chart should be cooked following the guidelines in any microwave cookbook.
6. During the first part of Sensor Cooking or Reheating, SENSING will appear on the display. Do not open the oven door or press STOP/CLEAR pad during this part of the cooking cycle. The measurement of vapor will be interrupted. If this occurs, an error message will appear. To continue cooking, touch the STOP/CLEAR pad and cook manually.

When the sensor detects the vapor emitted from the food, remainder of cooking or reheating time will appear. The door may be opened when remaining cooking time appears on the display. At this time, you may stir or season food, as desired.

7. If the sensor does not detect vapor properly when cooking or reheating foods, error messages will be displayed, and the oven will turn off.
8. Check food for correct temperature after cooking. If additional time is needed, continue to cook manually.

Covering Foods

Some foods work best when covered. Use the cover recommended in the procedure for these foods.

1. Casserole lid.
2. Plastic wrap: Use plastic wrap recommended for microwave cooking. Cover dish loosely; allow approximately 1/2 inch to remain uncovered to allow steam to escape. Plastic wrap should not touch food.
3. Wax paper: Cover dish completely; fold excess wrap under dish to secure. If dish is wider than paper, overlap two pieces at least one inch to cover.

Be careful when removing any covering to allow steam to escape away from you.

ONE TOUCH SENSOR

REHEAT / POPCORN / BAKED POTATOES

You can cook many foods by touching just one pad. You don't need to calculate cooking time or power level.

- Suppose you want to reheat canned chili.



1 Press Reheat pad and then touch the Regular Turntable On to reheat canned chili.



2 Press the START pad.



3 After cooking, follow instructions.

ONE TOUCH SENSOR COOKING CHART

FOOD	AMOUNT	PROCEDURE
Reheat Regular Turntable On	4 - 36 oz	Place in dish or casserole slightly larger than amount to be reheated. Flatten, if possible. Cover with lid, plastic wrap or wax paper. Use covers such as plastic wrap or lids with larger quantities of more dense foods such as stews. After reheating, stir well, if possible. Re-cover and allow to stand 2 to 3 minutes. Foods should be very hot. If not, continue to heat with variable power and time.
Stirrable Turntable Off	13x9x2 glass utility casserole	Ideal for reheating stirrable casseroles, such as macaroni and cheese or stew. Cover with vented plastic wrap or wax paper. Follow directions. At end, stir and allow to stand, covered, for 5 to 10 minutes.
Non Stirrable Turntable Off	13x9x2 glass utility casserole	Ideal for reheating non-stirrable casseroles, such as lasagna. Cover with vented plastic wrap or wax paper. Follow directions. At end, stir and allow to stand, covered, for 5 to 10 minutes.
Popcorn	1 pkg 3.0 - 3.5 oz (Regular) 1.5 - 1.75 oz (Snack)	Use only popcorn packaged for microwave oven use. Try several brands to decide which you like the best. Do not try to pop unpopped kernels.
Baked Potatoes	1 - 6	Pierce. Place on paper-towel-lined turntable. After cooking, remove from oven, wrap in aluminum foil and let stand 5 to 10 minutes.

6x6 NO GUESS COOKING

Your oven has six food pads and each pad has six selections. Many sensor cooked foods are included in 6x6 NO GUESS COOKING. See the sensor cooking information on page 16. For foods not using the sensor, follow the directions on the Touch Screen

to enter quantity. When cooking foods with the sensor, it is not necessary to enter quantity or weight. The foods using the sensor are indicated with “*” in the chart on page 19.

VEGETABLES

The desired doneness can be selected for any vegetables choice.

- Suppose you want to cook broccoli (normal):

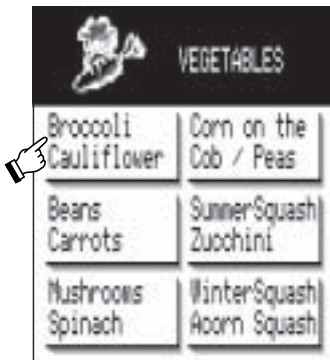

- 1 Press the Vegetables pad and then touch the desired vegetable: Broccoli.



- 2 Touch the desired doneness, and the oven will start automatically. When the sensor detects the vapor emitted from the food, remaining cooking time will appear. The oven door can be opened whenever the count down time is displayed on the Touch Screen.



- 3 After cooking, follow instructions.

NOTE:

You can also start the cooking by pressing the START pad at step 2. At that time “normal” is selected automatically. The doneness can be changed after pressing the START pad by touching the desired doneness on the display within seven seconds.

MEATS - POULTRY - FISH/SEAFOOD FROZEN FOODS - PASTA GRAINS

- Suppose you want to cook 2.0 lb boneless pork loin:



- 1 Press Meats pad and then touch the desired meat: Boneless Pork Loin.



- 2 Enter desired weight by touching the screen. Then press the START pad.



- 3 After cooking, follow instructions.

6x6 NO GUESS COOKING

6x6 NO GUESS COOKING CHART

FOOD	AMOUNT
VEGETABLES	
BROCCOLI / CAULIFLOWER*	.25 - 2 lb
BEANS / CARROTS*	.25 - 1.5 lb
MUSHROOMS / SPINACH*	.25 - 2 lb
CORN ON THE COB / PEAS*	.25 - 1.5 lb
SUMMER SQUASH / ZUCCHINI*	.25 - 2 lb
WINTER SQUASH / ACORN SQUASH*	.25 - 2 lb

MEATS	
GROUND BEEF*	.25 - 2.0 lb
BONELESS PORK LOIN	2.0 - 3.5 lb
MEAT LOAF	1.0 - 2.0 lb
POT ROAST	2.0 - 3.5 lb
STEW	1.0 - 2.0 lb
SPARERIBS	1.0 - 3.0 lb

POULTRY	
BONELESS CHICKEN BREASTS*	.5 - 2.0 lb
BONE-IN CHICKEN PIECES*	.5 - 3.0 lb
WHOLE CHICKEN	2.5 - 6.0 lb
TURKEY BREAST	3.0 - 6.0 lb
TURKEY DRUMSTICK	1.0 - 3.0 lb
GROUND POULTRY*	.25 - 2.0 lb

FOOD	AMOUNT
FISH / SEAFOOD	
FISH FILLETS*	.25 - 2.0 lb
FISH STEAKS*	.25 - 2.0 lb
SHRIMP*	.25 - 2.0 lb
SCALLOPS*	.25 - 2.0 lb
CLAMS & MUSSELS*	up to 1 1/2 dozen
FISH KABOBS* weight of fish	.25 - 1.5 lb

FROZEN FOOD	
VEGETABLES*	.25 - 1.25 lb
ENTREES*	6 - 17 oz
MAIN DISHES*	24 - 40 oz
SNACKS*	3 - 8 oz
SOFTEN ICE CREAM	Pint, Quart, Half Gallon
THAW JUICE CONCENTRATE	6, 12, 16 oz

PASTA / GRAINS	
WHITE RICE*	1/2 - 2 cups
BROWN RICE*	1/2 - 2 cups
FRESH PASTA	8 - 9 oz
DRY PASTA	2 - 8 oz
GRITS	.3 - 2.0 cups
COUSCOUS	.5 - 2.0 cups

NOTE:

1. You can enter the amount only within the range of the 6x6 NO GUESS COOKING CHART.

* It is not necessary to enter quantity with these foods because they are cooked by the sensor.

2. 6x6 NO GUESS COOKING can be programmed with More or Less Time Adjustment. See page 34.

MORE FROM YOUR MICROWAVE 6x6

More From Your Microwave 6x6 has six cooking categories to assist with meal preparation. There are some foods in the Breakfast Bar and Lunch on the Run

Run that use the sensor. See sensor cooking information on page 16. For foods not using the sensor, follow the directions on the screen to enter quantity.

BREAKFAST BAR / LUNCH ON THE RUN

- Suppose you want to use Breakfast Bar to cook two servings of hot cereal.



1 Press MORE FROM YOUR MICROWAVE 6x6 pad and then touch the desired category: Breakfast Bar.



2 Select the desired food: Hot Cereal.

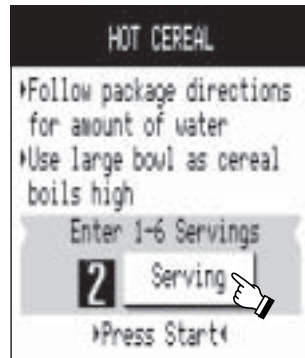

3 Enter desired quantity by touching the screen. Then press START pad. When the oven stops, follow instructions.

BREAKFAST BAR CHART

FOOD	AMOUNT
Scrambled Eggs	1 - 9 eggs
Bacon*	2 - 6 slices
Hot Cereal	1 - 6 servings
Fresh Rolls or Muffins	1 - 8
Frozen Rolls or Muffins	1 - 8
Frozen Breakfast Food*	1 (3 - 6 oz)

* It is not necessary to enter quantity with these foods because they are cooked by the sensor.

LUNCH ON THE RUN CHART

FOOD	AMOUNT
Meal in a Cup*	1 cup (6 - 8 oz)
Hot Dogs in Buns*	1 - 4
Soup*	1 - 6 cups
Microwave Pizza*	1 (6 - 8 oz)
Pizza Reheat**	1 - 6 slices
Frozen Sandwich*	1 (3 - 6 oz)

** Must enter number of slices on Touch Screen. Other foods in chart do not require quantity input. See Touch Screen for directions.

NOTE:

1. You can program with More or Less Time Adjustment. See page 34.
2. More or less than the quantity listed in the chart should be cooked following the guidelines in any microwave book.
3. The final cooking result will vary according to the food condition (e.g. initial temperature, shape, quality, covering). Check food for correct temperature after cooking. If additional time is needed, continue to cook manually.

MORE FROM YOUR MICROWAVE 6x6

ONE DISH DINNERS - LOW CALORIE ENTREES - SUPPER SOUPS AND SAUCES - DELICIOUS DESSERTS

- Suppose you want to use One Dish Dinners to cook Spicy Couscous.



- 1 Press MORE FROM YOUR MICROWAVE 6x6 pad and then touch the desired category: One Dish Dinners.



- 2 Select the desired food: Spicy Couscous.

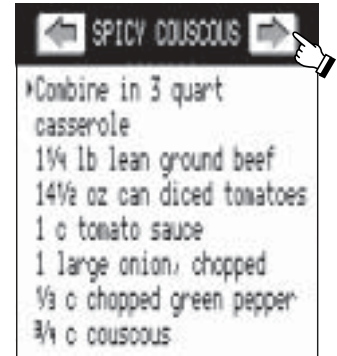

- 3 All ingredients for the recipe and step-by step procedures are shown. Touch the arrow marks on the screen to read the recipe through before cooking. The forward and back arrows allow one to check all steps BEFORE beginning any cooking.



- 4 When ready to cook, press START pad. The oven has the cooking instructions in it so it is not necessary for you to make any decisions!



- 5 When the oven stops, read the instructions on the Touch Screen, open the door, complete the steps and close door. Press START pad.



- 6 After cooking, follow instructions.

MORE FROM YOUR MICROWAVE 6x6

RECIPES FOR ONE DISH DINNERS

(Recipes serve 6)

Spicy Couscous

- 1¹/₄ lb lean ground beef
- 14¹/₂ oz can diced tomatoes
- 1 c tomato sauce
- 1 large onion, chopped
- 1¹/₃ c chopped green pepper
- 3⁴/₄ c couscous
- 1 clove garlic, minced
- 1¹/₂ tbsp chili powder
- 1 tsp ground cumin
- 1 tsp dried oregano leaves
- 1 c raisins

Garnish: yogurt and chopped fresh parsley

Sweet & Sour Pork

- 1 c long grain rice
- 2 c pineapple juice
- 1¹/₂ c water
- 1¹/₄ c sweet & sour sauce
- 2 tbsp soy sauce
- 1 tbsp minced fresh ginger
- 1¹/₄ c honey
- 1¹/₄ lb boneless lean pork loin, cut into thin strips
- 20 oz can pineapple chunks, drained
- 3 c fresh or frozen stir-fry vegetables

Garnish: toasted sliced almonds

Beef Burgundy

- 1¹/₂ lb 3⁴/₄-inch beef rump or chuck cubes
- 4 tbsp flour
- 2 slices of bacon, minced
- 1 large onion, chopped
- 3 cloves garlic, minced
- 2¹/₂ c carrots
- 1 tsp salt
- 1¹/₂ tsp pepper
- 1 tsp thyme
- 2 tsp rosemary
- 1 c red wine
- 1 c beef bouillon
- 2 c sliced mushrooms
- 2 c pearl onions

Seafood Pasta

- 8 - 9 oz fresh tortellini
- 2 c water
- 1³/₄ c creamy Alfredo sauce
- 1¹/₄ lb raw shellfish like shrimp, scallops, crab
- 3 c thinly sliced fresh vegetables like carrots, mushrooms, green beans

Garnish: 1¹/₃ c grated Parmesan cheese

Salsa Chicken

- 1¹/₄ oz dry taco seasoning
- 1 lb boneless chicken breast thin strips
- 6 oz pkg yellow rice mix with seasoning packet
- 2¹/₂ c hot water
- 2¹/₂ c frozen peas
- 1 c canned corn
- 1¹/₂ c apricot preserves
- 14¹/₂ oz can diced tomatoes

Vegetarian Orzo

- 1 c orzo
- 3¹/₂ c vegetable bouillon
- 1¹/₄ c pesto sauce
- 1¹/₂ c small pieces of sundried tomatoes
- 1 tbsp minced garlic
- 1 tbsp Italian seasoning
- 3 c chopped green, red, orange & yellow peppers
- 1 large onion, thinly sliced
- 14 oz can artichoke hearts, drain & quarter
- 3 oz pitted ripe olives, cut in half

Garnish:

- 1¹/₂ c Parmesan cheese, freshly grated
- 1¹/₄ c pinenuts

MORE FROM YOUR MICROWAVE 6x6

RECIPES FOR LOW CALORIE ENTREES

(Recipes serve 6)

Stuffed Acorn Squash

- 3 acorn squash each weighing $\frac{3}{4}$ lb
- $1\frac{1}{4}$ lb ground turkey
- $\frac{1}{2}$ onion, chopped
- 2 carrots, shredded
- 1 green pepper, chopped
- 1 tbsp catsup
- $\frac{1}{2}$ tsp salt
- $\frac{1}{4}$ tsp pepper
- $\frac{1}{2}$ c instant rice
- 20 oz can crushed pineapple, drained
save juice
- $\frac{1}{2}$ c teriyaki sauce
- $\frac{1}{4}$ c sweet and sour sauce

Steak Fajitas

- 1 lb beef flank steak, cut in diagonal inch
strips
- $\frac{1}{2}$ c orange juice
- 3 tbsp lime juice
- 2 tbsp minced garlic
- 1 tbsp Worcestershire sauce
- $1\frac{1}{2}$ tbsp chili powder
- 1 tsp cumin
- 2 c red, green and yellow pepper strips
- 1 large onion, chopped
- 1 c black beans, rinsed and drained
- 6 10-inch warm flour tortillas
- 1 large tomato, chopped
- $\frac{1}{2}$ c salsa
- $\frac{1}{2}$ c fat free sour cream

Thai Chicken Kabobs

- 2 tbsp lime juice
- 1 tsp cooking oil
- 1 tsp soy sauce
- $\frac{1}{8}$ tsp red pepper
- $1\frac{1}{4}$ lb boneless chicken, cut into 1-inch cubes
- 4 onions, quartered
- 2 red peppers, cut into 1-inch pieces
- 2 tsp light peanut butter

Glazed Roast Pork Tenderloin

- $1\frac{1}{2}$ lb whole pork tenderloin
- 2 tsp rosemary, salt and pepper
- $1\frac{1}{4}$ lb sweet potatoes, 2-inch cubes
- 1 orange, thinly sliced
- Glaze:
- 8 oz whole cranberry sauce
- $\frac{1}{2}$ c red wine
- 2 tbsp steak sauce
- 3 tbsp flour

Salmon Romanoff

- 12 oz dry egg noodles
- 2 c skim milk
- 1 c water
- 1 pint fat free sour cream
- $1\frac{1}{2}$ oz package dry ranch salad dressing mix
- 15 oz can salmon, drained and flaked
- 8 oz can sliced mushrooms, drained
- $\frac{1}{3}$ c chopped green onions
- 1 tsp dill weed

Ratatouille

- $\frac{1}{4}$ c olive oil
- 1 medium eggplant, peeled and cut in 1-inch
cubes
- 1 large onion, sliced thinly
- 4 small new potatoes, cut in $\frac{3}{4}$ -inch cubes
- 1 clove garlic, minced
- 1 zucchini, sliced thinly
- 1 green pepper, cut into thin strips
- 2 c sliced fresh mushrooms
- $14\frac{1}{2}$ oz can seasoned, diced tomatoes
- $1\frac{1}{2}$ tsp dried basil leaves
- $1\frac{1}{2}$ tsp marjoram leaves
- salt and pepper to taste

MORE FROM YOUR MICROWAVE 6x6

RECIPES FOR SUPPER SOUPS AND SAUCES

(Recipes serve 6)

Chicken Noodle

- 1 tsp oil
- 1 medium onion, sliced thinly
- 1 c thin sliced celery
- 2 c thin sliced carrots
- 5 c chicken broth
- 1 1/2 lb bone-in chicken pieces
- 1 c fine egg noodles
- 1/2 c chopped parsley
- salt and pepper

Bouillabaisse

- 2 tbsp olive oil
- 2 large onions, chopped finely
- 3 cloves garlic, minced
- 8 oz bottle clam juice
- 2 1/2 c dry white wine
- 1 1/2 oz can diced tomatoes
- 2 1/2 c finely chopped fennel
- 3/4 c instant rice
- 3 tbsp chopped parsley
- 1 bay leaf
- 1 tsp dried thyme
- 1/2 tsp ground pepper
- 8 oz boneless white fish, cut into 6 pieces
- 8 oz scallops
- 8 oz shrimp, peeled and deveined

Curried Vegetable

- 2 tbsp oil
- 2 c 1/2-inch sweet potato cubes
- 2 c 1/2-inch white potato cubes
- 1 medium zucchini, cut into 1-inch cubes
- 1 medium red pepper, cut into 1/2-inch cubes
- 1 medium green pepper, cut into 1/2-inch cubes
- 1 medium onion, cut into 1/2-inch cubes
- 2 tbsp curry powder
- 1 tsp ground cumin
- 15 oz can garbanzo beans, rinsed and drained
- 1 1/2 oz can diced tomatoes
- 15 oz can crushed tomatoes
- 1 tsp salt
- 4 c vegetable or chicken broth

Split Pea

- 3 c water
- 3 c vegetable bouillon
- 1 c dried split peas
- 1/2 c chopped onion
- 1 clove garlic, minced
- 1/2 tsp dried marjoram
- 1/2 tsp dried thyme leaves
- 1 bay leaf
- 1/8 tsp cayenne pepper
- 1 c sliced carrots
- 1 c diced potatoes
- 1/2 c sliced celery

Meat Sauce

- 1 lb ground beef
- 1/2 lb sweet Italian sausage
- 8 oz chopped, canned mushrooms, drained
- 1 medium onion, minced
- 2 cloves garlic, minced
- 1 stalk celery, minced
- 1 carrot, minced
- 1/2 c red wine
- 1/2 c water
- 28 oz can tomato puree
- 6 oz can tomato paste
- 1 tsp sugar
- 1 tsp dried basil
- 1 tsp oregano
- 1/4 tsp crushed red pepper
- 1 tsp salt
- 1/4 tsp pepper

Vegetarian Chili

- 1 c sliced carrots
- 1 c sliced celery
- 1/2 c chopped red pepper
- 1/2 c chopped green pepper
- 1/2 c sliced green beans
- 1 large onion, minced
- 2 cloves garlic, minced
- 28 oz can crushed tomatoes
- 19 oz can kidney beans, rinsed and drained
- 19 oz can black beans, rinsed and drained
- 1 1/2 c water
- 1/2 c barley
- 2 tbsp chili powder
- 1 tsp cumin
- 2 tsp Italian seasoning
- 1 tsp salt
- 1/4 tsp pepper

Garnish: Parmesan cheese or sour cream

MORE FROM YOUR MICROWAVE 6x6

RECIPES FOR DELICIOUS DESSERTS

(Recipes serve 6)

Almond Bread Pudding

- 2 c half and half
- 2 tbsp unsalted butter, melted
- 2 large eggs, beaten
- 3/4 c sugar
- 1 tsp almond extract
- 1/2 c golden raisins
- 1/2 c slivered, blanched almonds, toasted
- 6 c 2-inch cubed French or Challah bread

Sauce:

- 1/4 c unsalted butter, melted
- 1/2 c sifted confectioners' sugar
- 1 large egg
- 2 tbsp bourbon

Caribbean Cake

- 2 tbsp butter, melted
- 1/4 c brown sugar
- 1/4 c apricot preserves
- 8 oz can crushed pineapple drained well
- 2 tbsp sliced, blanched almonds
- 1/3 c dried, sweetened cranberries (Craisins)
- 1 9 oz pkg yellow cake mix or 1/2 box regular size
- 1 egg
- 2 tbsp rum
- 6 tbsp pineapple juice and/or water

Chocolate Zucchini Cake

- 1/4 c soft butter
- 1/2 c sugar
- 1 c all-purpose flour
- 2 tbsp cocoa
- 1/4 tsp baking soda
- 1 tsp baking powder
- 1/4 tsp cinnamon
- 1 c shredded zucchini
- 1/2 c buttermilk
- 1 egg
- 1 tsp vanilla
- 1/2 c chopped pecans
- 1/2 c semisweet chocolate chips
- confectioners' sugar

Cherry Pie Pudding

- 21 oz cherry pie filling
- 4 c sponge or angel food cake cubes
- 2 c milk
- 4 eggs
- 1 tbsp sugar
- 1/2 tsp almond extract
- 1 16 oz can drained, Bing cherries

Pumpkin Pie

- 10 1/2 oz bag marshmallows
- 1 1/2 c canned pumpkin
- 1/2 tsp pumpkin pie spice
- 1/4 tsp salt
- 1 tsp grated orange rind
- 8 oz thawed, non-dairy whipped topping
- 9-inch prepared graham cracker crust

Turtle Bars

- 1 1/2 c quick oatmeal
- 1/2 c light brown sugar
- 1/2 c all-purpose flour
- 1/2 c melted butter
- 20 caramel candies
- 1 tbsp milk
- 1/2 c milk chocolate chips
- 1/2 c pecan pieces

DEFROST 3+6

Defrost 3+6 pad has two special defrosting methods.

SUPER DEFROST

SuperDefrost rapidly defrosts specific foods and weights found in the SUPER DEFROST chart.

- Suppose you want to defrost 1.0 pound boneless chicken.

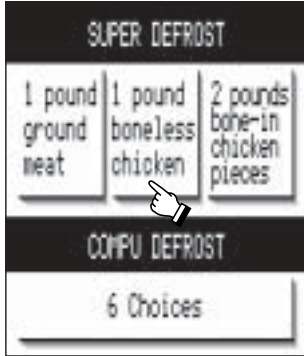

1 Press Defrost 3+6 pad and then touch desired food: 1 pound boneless chicken. The oven will start automatically.



2 When the oven stops, read instructions on the screen, open the door, complete the instructions and close the door. Press START pad.

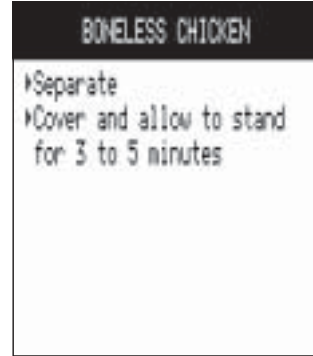

3 After the defrost cycle ends, read the screen. Remove the food from oven, cover and let stand for the suggested time to allow defrosting to be completed.

NOTE:

1. To defrost foods above or below the weights allowed on the SUPER DEFROST Chart, use CompuDefrost or Manual Defrost. See CompuDefrost on page 27 and Manual Defrost on page 16.
2. SuperDefrost can be programmed with More or Less Time Adjustment. See page 34.

SUPER DEFROST CHART

FOOD	AMOUNT	PROCEDURE
Ground meat	1.0 lb	At pause, turn over, remove any thawed pieces and break remainder apart. At end, let stand, covered, for 3 to 5 minutes.
Boneless Chicken	1.0 lb	At pause, turn over and separate into pieces. At end, let stand, covered, for 3 to 5 minutes.
Bone-in Chicken Pieces	2.0 lb	At pause, turn over and separate into pieces. At end, let stand, covered, for 3 to 5 minutes.

NOTE:

SuperDefrost provides just enough defrosting that the foods can be used in recipes or for cooking. There will be some ice crystals remaining.

DEFROST 3+6

COMPU DEFROST

CompuDefrost automatically defrosts all the foods found in the COMPU DEFROST chart below.

- Suppose you want to defrost a 2.0 pound steak.



- 1 Press Defrost 3+6 pad and then touch COMPU DEFROST 6 Choices.



- 2 Touch the desired food: Steaks.



- 3 Enter desired weight by touching the screen. Then press START pad.

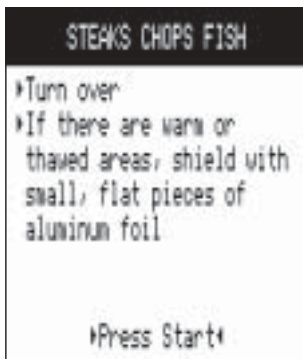

- 4 When the oven stops, read instructions on the screen, open the door, complete the instructions and close the door. Press START pad.



- 5 When the oven stops, read instructions on the screen, open the door, complete the instructions and close the door. Press START pad.

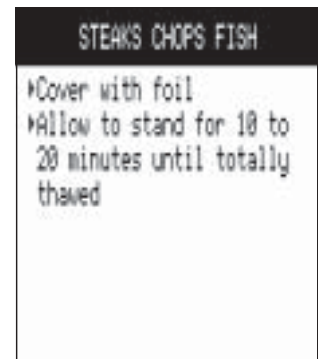

- 6 After the defrost cycle ends, read the screen. Remove the food from oven, cover and let stand for the suggested time to allow defrosting to be completed.

COMPU DEFROST CHART

FOOD	AMOUNT	STANDING TIME
Ground Meat	.5 - 3.0 lb	5 - 10 min.
Steaks, Chops / Fish	.5 - 4.0 lb	10 - 20 min.
Chicken Pieces	.5 - 3.0 lb	10 - 20 min.
Roasts	2.0 - 4.0 lb	30 - 45 min.
Casserole	2 - 6 cups	5 - 15 min.
Soup	1 - 6 cups	5 - 15 min.

NOTE:

1. You can input the amount only within the range of the COMPU DEFROST CHART.
2. CompuDefrost can be programmed with More or Less Time Adjustment. See page 34.
3. To defrost other foods or foods above or below the weights allowed on COMPU DEFROST CHART, use time and 30% power. See Manual Defrost on page 16.

BEVERAGE CENTER

Beverage Center enables you to restore coffee or tea to a more suitable drinking temperature or to prepare instant coffee or tea.

- Suppose you want to make two cups of coffee.

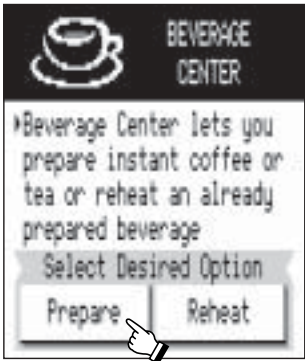

1 Press Beverage Center pad and then touch Prepare.

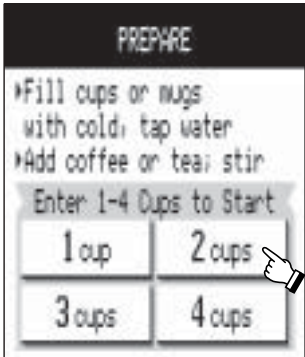

2 Touch desired number on the screen. The oven will start automatically.



3 When oven stops, follow instructions on the screen.

BEVERAGE CENTER CHART

FOOD	AMOUNT
Prepare coffee/tea	1 - 4 cups
Reheat	1/2 - 2 cups

KEEP WARM

Keep Warm enables you to keep cooked food at the ideal serving temperature for up to 30 minutes.

- Suppose you want to keep on cooked casserole warm for 5 minutes.

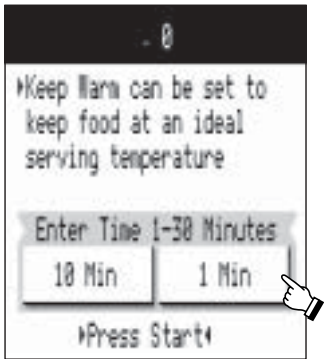

1 Press Keep Warm pad and then enter the desired time. Press START.



2 The display will begin counting down. During the warming time, Keep Warm will appear in the display.

Keep Warm can be programmed as the final stage in Multiple Sequence cooking. See page 15.

FAN OPTIONS

There are 3 choices in Fan Options.

- Suppose you want to turn the fan on at high speed.

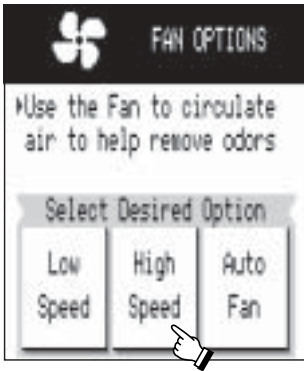

Press Fan Options pad and then touch the desired option: High Speed.



To turn the fan off, press the Fan Options again and touch Off on the display.

- Suppose you want to set the Auto Fan to stay on for a selected time.

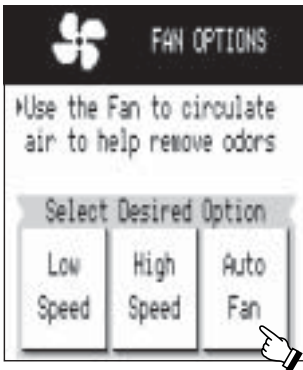

1 Press Fan Options pad and then touch the desired option: Auto Fan.

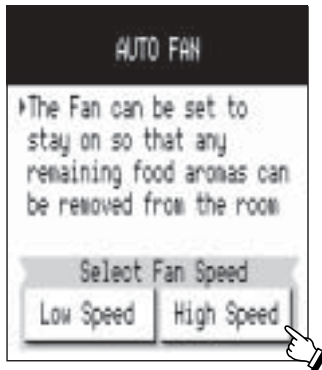

2 Select the desired speed: High Speed.



3 Select the desired time. Press the START pad.

LIGHT OPTIONS

There are 3 choices on Light Options.

- Suppose you want to turn the night light on.



Press Light Options pad and then touch the desired option: Night Light.



To turn the light off, press the Light Options again and touch Off on the display.

LIGHT OPTIONS

- Suppose you want to turn the Auto Night Light on.



- 1 Press Light Options pad and then touch the desired option: Auto Night Light.



- 2 Select the desired time. Press the START pad.

TURNTABLE ON/OFF

For most cooking, the turntable should be on; however the turntable can be turned off so that it does not rotate when extra large dishes, such as the popular 13 x 9 x 2 glass utility casserole, are used. The casserole should be placed on the turntable so that it is level.

The display indicates when the turntable is off. The door can be opened for checking food and the turntable will stay in the off position. After checking, close door and touch START

All special features can only be used with the turntable on. When the turntable is set in the off position, only manual operation can be used except for the Reheat function which can be used for both options.

When cooking large quantities of food which cannot be stirred, it is best to use a lower power level such as 40% or 50%. You may speed cooking for large amounts by programming 5 to 10 minutes on 100% power (HIGH) followed by the desired time on lower power. See page 15 for how to program multiple sequences. You may wish to reverse a large casserole once during cooking; simply open door, reposition casserole, close door and touch START.

- Suppose you want to turn the turntable off.



Press Turntable On/Off. The turntable off icon will appear on the top left of the display.

To turn the turntable on again, press Turntable On/Off. The turntable off icon will disappear.

USING THE RACK

The Rack allows several foods to be cooked or reheated at one time. However, for the best cooking and reheating, use *the turntable on and the automatic features*.

When using the Rack, set time and power level manually. Allow plenty of space around and between the dishes. Pay close attention to the cooking/reheating progress. Reposition the foods and reverse them from rack to turntable at least once during any cooking or reheating time. Using a lower power level will assist in better cooking/reheating uniformity.

AVOID:

- Storing the Rack in the oven when not in use.
- Popping popcorn on the turntable with the Rack in the oven.
- Using any browning dish on the Rack.
- Using special features with the Rack. Special features are designed to be used with foods only on the revolving turntable.
- Cooking directly on the Rack—use microwave-safe cookware.

SET UP

Set Up has six functions.

1. Clock
2. Auto Start
3. Sound Adjustment
4. Child Lock
5. Video Demo
6. Screen Contrast

To use any function, press Set Up, touch desired function and follow directions on the screen.

1. CLOCK

Press the Set Up pad, touch Clock and follow the directions on the screen. See page 13.

2. AUTO START

The Auto Start function allows you to set your oven to start automatically at a later time.

- Suppose you want to start cooking a stew for 20 minutes on 50% power at 4:30 P.M. Before setting, check to make sure the clock is showing the correct time of day.

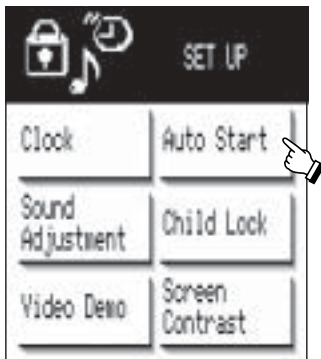

- 1 Press Set Up pad and then touch the desired function: Auto Start.

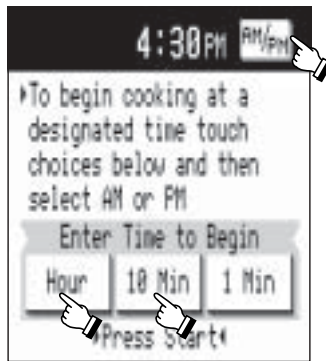

- 2 Enter start time (4:30) using the screen choices and then touch PM. Press START pad.

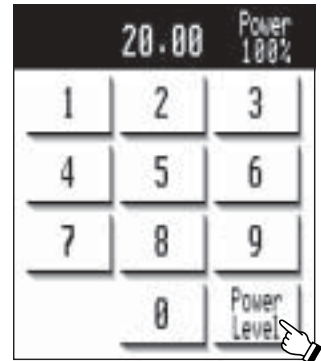

- 3 Enter cooking time, 2, 0, 0, 0 by using numbers on the screen. Touch Power Level.

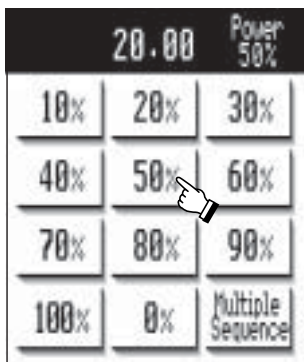

- 4 Touch 50%. The top line of the display will show time and chosen power level. Press START pad.



- 5 Auto Start time will appear.

NOTE:

1. Auto Start can be used for manual cooking only, if clock is set.
2. Be sure to choose foods that can be left in the oven safely until the Auto Start time. Acorn or butternut squash are often a good choice.

SET UP

3. SOUND ADJUSTMENT

The oven offers a choice of Simple Beep, Melody or No Sound. The oven comes set for Melody. Touch your choice on the screen and then press START. The selected sound does not change even if the electrical power supply is interrupted. Note that even when No Sound is chosen, there will be a sound for the Kitchen Timer, if it was set.

Reminder:

An audible signal reminds you that cooking, defrosting or reheating has finished. The sound will repeat every 60 seconds and continue for 30 minutes unless you touch STOP/CLEAR or open the door. To set the Reminder, touch On on the End of Cooking Reminder screen. The setting does not change even if the electrical power supply is interrupted. The Reminder cannot be set if “No Sound” was selected.

4. CHILD LOCK

The Child Lock prevents unwanted oven operation such as by small children. The oven can be set so that the control panel is deactivated or locked.

5. VIDEO DEMO

The Video Demo is an automated “tour” through many of the features of the SMART & EASY TOUCH SCREEN oven. You may wish to observe it when the oven is new or when you are teaching family members how to use the oven. There are five short segments in the Video Demo.

6. SCREEN CONTRAST

Normally there is no need to change the display contrast; however, should you wish to do so, touch Lighter or Darker until the contrast is as desired. And then press START pad. Be cautious when touching Lighter so that the display is always readable. The selected contrast will not change even if the electrical power supply is interrupted.

OTHER CONVENIENT FEATURES

MINUTE PLUS

Minute Plus allows you to cook for a minute at 100% power by simply touching the MINUTE PLUS pad. You can also extend cooking time in multiples of one minute by repeatedly touching the MINUTE PLUS pad during manual cooking.

- Suppose you want to heat a cup of soup for one minute using 100% power.



NOTE:

To use Minute Plus, touch pad within three minutes after cooking, closing the door, touching the STOP/CLEAR pad or during cooking.

Touch MINUTE PLUS pad on control panel.

OTHER CONVENIENT FEATURES

MINUTE PLUS+

Touch Minute Plus+ on the screen to access a new screen with 12 common cooking times at 100% power. Touch desired time and the oven starts automatically.

- Suppose you want to melt butter for 30 seconds.



1 Touch Minute Plus+.

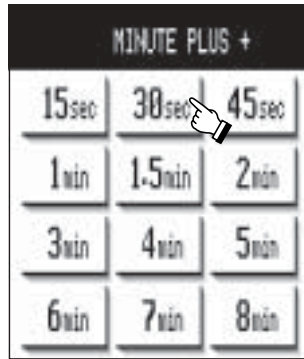

2 Touch desired time: 30 seconds.

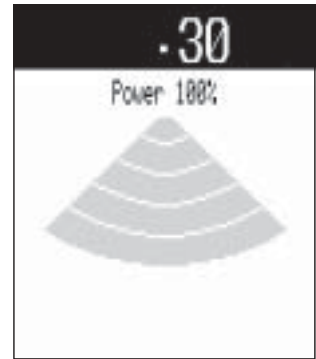

3 The oven will start automatically.

KITCHEN TIMER

Use this feature as a general purpose timer. You can enter any time up to 99 minutes and 99 seconds. If you want to cancel the timer during the count down phase, simply press STOP/CLEAR and the display will return to the Home Page.

- Suppose you want to time a three minute long distance phone call:



1 Touch Kitchen Timer.



2 Enter desired time by touching numbers : 3, 0, 0. Press START pad.



3 The Kitchen Timer will start counting down.

NOTE:

Even if all sound is off, the oven will beep when the Kitchen Timer ends.

OTHER CONVENIENT FEATURES

MORE OR LESS TIME ADJUSTMENT

The programmed cooking times are tailored to the most popular tastes. To adjust the cooking time to your individual preference use the “more” or “less” feature to either add or reduce cooking time.

- Suppose you want to cook Ground Beef for more time:

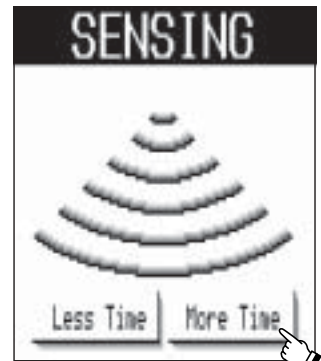
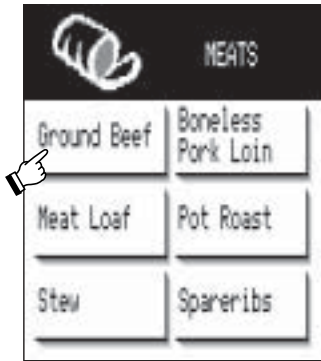

1 Press Meats pad in the 6x6 NO GUESS COOKING and then touch Ground Beef.

2 Prepare the food following the information on the screen. And press START pad.

3 After pressing the START pad, Less Time and More Time will appear. Touch desired choice, if any.

NOTE:

1. Once you have selected either More Time or Less Time, it cannot be changed.
2. Choosing More Time or Less Time must be done within seven seconds after touching START.

CLEANING AND CARE

DOOR

Wipe the window on both sides with a damp cloth to remove any spills or splatters. Metal parts will be easier to maintain if wiped frequently with a damp cloth. **Avoid the use of harsh abrasives.**

EXTERIOR

The outside surface is painted. Clean the outside with mild soap and water; rinse and dry with a soft cloth. **Do not use any type of household or abrasive cleaner.**

INTERIOR

Cleaning is easy because no heat is generated to the interior surfaces; therefore, there is no baking and setting of spills or spattering. To clean the interior surfaces, wipe with a soft cloth and warm water. **DO NOT USE ABRASIVE OR HARSH CLEANERS OR SCOURING PADS.** For heavier soil, use baking soda or a mild soap; rinse thoroughly with hot water. **NEVER SPRAY OVEN CLEANERS DIRECTLY ONTO ANY PART OF THE OVEN.**

WAVEGUIDE COVER

Carefully wash any food particles from the waveguide cover located on the right side in the oven cavity. Do not remove the waveguide cover.

ODOR REMOVAL

Occasionally, a cooking odor may remain in the oven. To remove, combine 1 cup water, grated peel and juice of 1 lemon and several whole cloves in a 2 cup glass measuring cup. Boil for several minutes using 100% power. Allow to set in oven until cool. Wipe interior with a soft cloth.

CONTROL PANEL

Care should be taken in cleaning the control panel. If the control panel becomes soiled, open the oven door before cleaning. Wipe the panel with a cloth dampened slightly with water only. Dry with a soft cloth. Do not scrub or use any sort of chemical cleaners. Close door and touch STOP/CLEAR.

TOUCH SCREEN

Wipe the touch screen with a damp cloth and then dry with a soft cloth. Do not allow soil to accumulate on the touch screen.

TURNTABLE / TURNTABLE SUPPORT

The turntable and turntable support can be removed for easy cleaning. Wash them in mild, sudsy water; for stubborn stains use a mild cleanser and scouring sponge as described above. They are also dishwasher-proof. Use upper rack of dishwasher. The turntable motor shaft is not sealed, so excess water or spills should be wiped up immediately.



Turntable

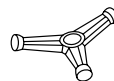

Turntable Support

GREASE FILTERS

Filters should be cleaned at least once a month. Never operate the fan or oven without the filters in place.

1. Pull down slightly on the tab toward the front of the oven and remove the filter. Repeat for the other filter.
2. Soak the filters in a sink or dish pan filled with hot water and detergent. **DO NOT** use ammonia or other alkali; they will react with the filter material and darken it.
3. Agitate and scrub with a brush to remove embedded dirt.
4. Rinse thoroughly and shake dry.
5. Replace by fitting the filter back into the opening.

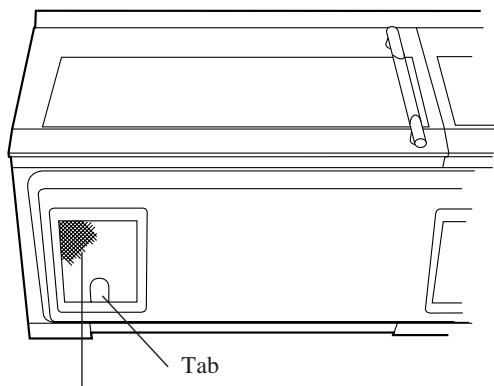

Grease filter

REPLACING PARTS

CHARCOAL FILTER

Charcoal Filter, Sharp Part number RK-230 which was enclosed with your oven, is used for nonvented, recirculated installation. The filter should be changed every 6 to 12 months depending on use. See page 6 for ordering information.

1. Disconnect power to the oven at the circuit breaker panel or by unplugging.
2. Remove center screw from the top center of the louver and push down carefully on the tab at each end of the louver to disengage.
3. Pull the louver away from the unit.
4. Change the charcoal filter.
5. To replace, insert the top tabs of hood louver into the 3 openings on the cavity faceplate holding louver at a slightly outward tilt. Rotate louver so the top tabs are positioned in the cavity faceplate openings. Push in the bottom of louver to ensure that the three bottom clips snap into the cavity faceplate. Check for proper engagement and replace the screw removed in step 2.

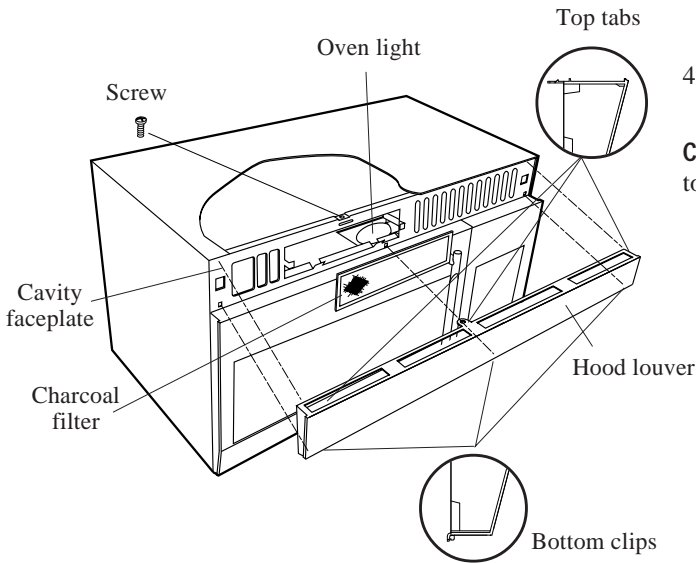

OVEN LIGHT

Remove the louver per instructions 1-3 above and charcoal filter, if used.

1. To replace light bulb, first disconnect power to the oven at the circuit breaker panel or by unplugging.
2. Open light cover located behind filter mounting by carefully pulling up on the front edge.

3. Remove old light bulb and replace only with equivalent watt bulb available from a Sharp Authorized Servicer or parts distributor. Bulbs are also available at most hardware stores or lighting centers. **DO NOT USE BULB LARGER THAN 30 WATTS.**
4. Replace the oven light cover by carefully pushing into place. Replace the charcoal filter, if used. Push the louver back into place and replace the louver mounting screw.

WORK LIGHT AND NIGHT LIGHT

1. To replace light bulbs, first disconnect power to the oven at the circuit breaker panel or by unplugging.
2. To release cover, remove the screw on the light cover. (See illustration.)
3. Replace light bulbs with equivalent watt bulb available from your Sharp Authorized Servicer or parts distributor. Bulbs are also available at most hardware stores or lighting centers. **DO NOT USE A BULB LARGER THAN 30 WATTS.**
4. Close light cover and secure with screw removed in step 2.

CAUTION: Light cover may become very hot. Do not touch glass when light is on.

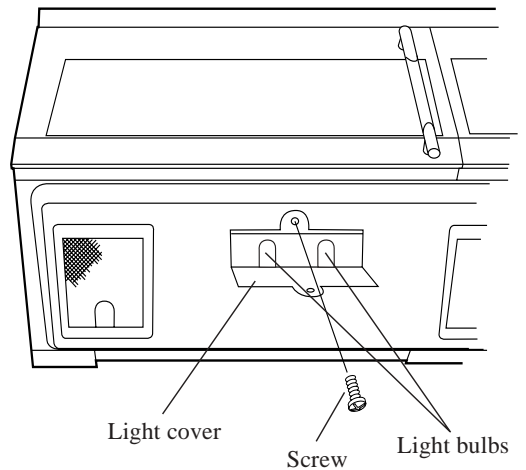

SPECIFICATIONS

R-1750, R-1751, R-1752, R-1754,

AC Line Voltage:	Single phase 120V, 60Hz, AC only
AC Power Required:	1600 watts, 14 amps.
Output Power:	1100 watts* (IEC Test Procedure)
Frequency:	2450 MHz
Outside Dimensions (not including handle):	29 ¹⁵ / ₁₆ "(W) x 16 ³ / ₈ "(H) x 16 ¹⁵ / ₁₆ "(D)
Cavity Dimensions:	21"(W) x 8 ⁷ / ₈ "(H) x 14 ⁷ / ₁₆ "(D)
Oven Capacity:	1.6 Cu. Ft.
Cooking Uniformity:	Turntable system
Weight:	Approx. (net) 55 lb, (gross) 60 lb
Work/Night Light:	2 bulbs 30w max. each (incandescent light bulbs)

* The International Electrotechnical Commission's standardized method for measuring output wattage. This test method is widely recognized.

In compliance with standards set by:

FCC – Federal Communications Commission Authorized.

DHHS – Complies with Department of Health and Human Services (DHHS) rule, CFR, Title 21, Chapter I, Subchapter J.



– This symbol on the nameplate means the product is listed by Underwriters Laboratories, Inc.

THE ULTIMATE ACCESSORY

- ✦ **Great recipes**
- ✦ **Reliable microwave reference guide**
- ✦ **Many color photos**
- ✦ **Step-by-step instructions**
- ✦ **Nutritional information for each recipe**
- ✦ **Durable wipe-clean soft cover with 128 8 1/2 x 11 pages**
- ✦ **Helpful tips and special techniques**

SHARP®

CAROUSEL MICROWAVE COOKBOOK

TO ORDER

Simply call this toll-free number : **1-800-642-2122**. Please have your credit card ready.

If you prefer to order by mail, complete and return the order form on page 38. Please include check or money order (payable to Sharp Accessories & Supplies Center) for \$6.00 plus \$4.25 shipping & handling and tax, if applicable, per book.

SATISFACTION GUARANTEED

You must be completely satisfied with the Sharp Carousel Microwave Cookbook. If, within 14 days, you are dissatisfied for any reason, simply return the book and we'll gladly refund your \$6.00 plus tax.

(SOLAMENTE ESCRITO EN INGLES!)

SERVICE CALL CHECK

Please check the following before calling for service:

Place one cup of water in a glass measuring cup in the oven and close the door securely.

Operate the oven for one minute at HIGH 100%.

- A Does the oven light come on? YES _____ NO _____
- B Does the cooling fan work? YES _____ NO _____
(Put your hand over the rear ventilating openings.)
- C Does the turntable rotate? YES _____ NO _____
It is normal for the turntable to turn in either direction.
- D Is the water in the oven warm? YES _____ NO _____

If "NO" is the answer to any of the above questions, please check electrical outlet, fuse and/or circuit breaker. If they are functioning properly, CONTACT YOUR NEAREST SHARP AUTHORIZED SERVICER. A microwave oven should never be serviced by a "do-it-yourself" repair person.

NOTE: If count-down time is appearing on the screen and counting down very rapidly, follow directions below to cancel Hidden Demo.
Press STOP/CLEAR pad and hold for four seconds until an audible signal is heard.
Quickly press STOP/CLEAR key four times within the next two seconds.

Cut along this line.

COOKBOOK ORDER FORM

Please send me _____ cookbooks at \$10.25 each \$ _____
 Illinois sales tax, (if applicable) per book \$.44 no. of books _____ \$ _____
 Other tax, (if applicable) no. of books _____ \$ _____
TOTAL ORDER AMOUNT \$ _____

- I have enclosed a check made payable to Sharp Accessories & Supplies Center.
- Please bill my VISA MASTERCARD AMERICAN EXPRESS

Acct. No. _____ Expiration date _____ / _____

Signature _____
(All credit card orders must be signed.)

Name _____

Address _____

City _____ State _____ Zip _____

Daytime Phone No. (_____) _____

Mail to: SHARP Accessories & Supplies Center Price is subject to change without notice.
 2130 Townline Road
 Peoria, Illinois 61615-1560

QUICK REFERENCE

ONE TOUCH SENSOR 17

- Reheat 17
- Popcorn 17
- Baked Potatoes 17

6x6 NO GUESS COOKING 18 - 19

- Vegetables** 19
 - Broccoli/Cauliflower
 - Beans/Carrots
 - Mushrooms/Spinach
 - Corn on the Cob/Peas
 - Summer Squash/Zucchini
 - Winter Squash/Acorn Squash
- Meats** 19
 - Ground Beef
 - Boneless Pork Loin
 - Meat Loaf
 - Pot Roast
 - Stew
 - Spareribs
- Poultry** 19
 - Boneless Chicken Breast
 - Bone-in Chicken Pieces
 - Whole Chicken
 - Turkey Breast
 - Turkey Drumstick
 - Ground Poultry
- Fish/Seafood** 19
 - Fish Fillets
 - Fish Steaks
 - Shrimp
 - Scallops
 - Clams & Mussels
 - Fish Kabobs
- Frozen Food** 19
 - Vegetables
 - Entrees
 - Main Dishes
 - Snacks
 - Soften Ice Cream
 - Thaw Juice Concentrate
- Pasta/Grains** 19
 - White Rice
 - Brown Rice
 - Fresh Pasta
 - Dry Pasta
 - Grits
 - Couscous

More From Your Microwave 20 - 25

- Breakfast Bar** 20
 - Scrambled Eggs
 - Bacon
 - Hot Cereal
 - Fresh Rolls or Muffins
 - Frozen Rolls or Muffins
 - Frozen Breakfast Food

- Lunch On The Run** 20
 - Meal in a Cup
 - Hot Dogs in Buns
 - Soup
 - Microwave Pizza
 - Pizza Reheat
 - Frozen Sandwich

- One Dish Dinners** 22
 - Spicy Couscous
 - Beef Burgundy
 - Salsa Chicken
 - Sweet and Sour Pork
 - Seafood Pasta
 - Vegetarian Orzo

- Low Calorie Entrees** 23
 - Stuffed Acorn Squash
 - Steak Fajitas
 - Thai Chicken Kabobs
 - Glazed Pork Tenderloin
 - Salmon Romanoff
 - Ratatouille

- Supper Soups and Sauces** 24
 - Chicken Noodle
 - Bouillabaisse
 - Curried Vegetable
 - Split Pea
 - Meat Sauce
 - Vegetarian Chili

- Delicious Desserts** 25
 - Almond Bread Pudding
 - Caribbean Cake
 - Chocolate Zucchini Cake
 - Cherry Pie Pudding
 - Pumpkin Pie
 - Turtle Bars

Defrost 3+6 26 - 27

- SUPER DEFROST** 26
 - 1 pound Ground Meat
 - 1 pound Boneless Chicken
 - 2 pounds Bone-in Chicken Pieces

- COMPU DEFROST** 27
 - Ground Meat
 - Steaks, Chops / Fish
 - Chicken Pieces
 - Roasts
 - Casserole
 - Soup

Beverage Center 27

- Prepare 27
- Reheat 27

Set Up 31 - 32

- Clock 31
- Child Lock 31
- Sound Adjustment 32
- Auto Start 32
- Video Demo 32
- Screen Contrast 32

QUICK REFERENCE



For more complete information and safety precautions, refer to your Operation Manual.

SET CLOCK

If the oven has just been plugged in, touch Set Clock on the screen and follow the directions. To reset the clock, press Set Up pad on the control panel. Then touch Clock on screen.

- 1 Enter the time of day (hour).
- 2 Enter the time of day (minutes).
- 3 Select AM or PM and then press **START** pad.

START

MANUAL OPERATION

High Power Cooking

- 1 Enter cooking time by touching numbers on the home page.
- 2 Press **START** pad.

START

Variable Power Cooking

- 1 After Step 1 above, touch Power Level on the screen.
- 2 Touch desired Power Level (Ex: 30%).
- 3 Press **START** pad.

START

ONE TOUCH SENSOR: REHEAT

Press **Reheat** pad and touch desired function. Follow the directions on the TOUCH SCREEN and press START. When sensor detects the vapor emitted from the food, remainder of cooking time will appear.

Reheat

MORE FROM YOUR MICROWAVE 6X6

- 1 Press the **MORE FROM YOUR MICROWAVE 6x6** pad and then touch the desired category.
- 2 Select the desired food from the screen.
- 3 Follow directions on the screen.
- 4 When the oven stops, follow instructions.

MORE FROM YOUR MICROWAVE 6x6

START

6x6 NO GUESS COOKING

For foods not using the sensor, follow the directions on the screen to enter quantity. When cooking foods with the sensor, it is not necessary to enter quantity or weight.

- 1 Press the **Vegetables** pad and then touch the desired vegetable.
- 2 Touch the desired doneness and the oven will start automatically.
- 3 After cooking, follow instructions.

Vegetables

DEFROST 3+6: COMPU DEFROST

- 1 Press the **Defrost 3+6** pad and then touch COMPU DEFROST 6 Choices.
- 2 Select the desired food and weight by touching the screen.
- 3 Press **START** pad.
- 4 Follow instructions.
- 5 After the defrost cycle ends, read the screen. Remove the food from oven, cover and let stand for the suggested time to allow defrosting to be completed.

Defrost 3+6

START

SET UP: AUTO START

The Auto Start function allows you to set the oven to start automatically at a later time.

- 1 Press the **Set Up** pad and then touch Auto Start on the screen.
- 2 Follow instructions.

Set Up

MINUTE PLUS

Minute Plus allows you to cook for one minute at 100% power by simply touching the **MINUTE PLUS** pad on the control panel.

MINUTE PLUS

MINUTE PLUS+

Touch Minute Plus+ on the screen to access a new screen with 12 common cooking times at 100% power. Touch desired time and the oven starts automatically.

Carousel® and Auto-touch® are registered trademarks of Sharp Corporation.

SHARP SHARP ELECTRONICS CORPORATION
Sharp Plaza, Mahwah, New Jersey 07430-2135

TINSEB228MRK0 Printed in USA

