

SHARP®

TOASTER OVEN WITH MICROWAVE OPERATION MANUAL

WARM & TOASTY™

MODEL

R-55TS

CONTENTS

- Precautions to Avoid Possible Exposure to Excessive Microwave Energy Inside Front Cover
- For Customer Assistance ... Inside Front Cover
- Consumer Limited Warranty 1
- Product Information Card 1
- Important Safety Instructions 2
- Unpacking and Installation Instructions... 3
- Grounding Instructions 3
- Information You Need to Know 4-7
- Part Names 8-9
- Before Operating 10
- Manual Operation 10-12
- Special Features 12-20
 - Automatic Cooking 12
 - Microwave Options 16
 - Express Defrost 18
 - Manual Defrost 19
- Other Convenient Features 21-22
- Cleaning and Care 23
- Service Call Check 24
- Specifications 24

READ ALL INSTRUCTIONS CAREFULLY BEFORE USING

FOR CUSTOMER ASSISTANCE

To aid in reporting this toaster oven with microwave in case of loss or theft, please record below the model number and serial number located on the unit. We also suggest you record all the information listed and retain for future reference.

Please provide the following information when you write or call: model number, serial number, date of purchase, your complete mailing address (including zip code), your daytime telephone number (including area code) and description of the problem.

MODEL NUMBER _____	SERIAL NUMBER _____
DATE OF PURCHASE _____	
Dealer _____	Telephone _____
Service _____	Telephone _____

TO PHONE:

DIAL 1-800- BE-SHARP (237-4277) for :
SERVICE (for your nearest Sharp Authorized Servicer)
PARTS (for your authorized parts distributor)
ADDITIONAL CUSTOMER INFORMATION

DIAL 1-800-642-2122 for :
ACCESSORIES

TO WRITE:

Sharp Electronics Corporation
Customer Assistance Center
1300 Naperville Drive
Romeoville, IL 60446-1091

TO ACCESS INTERNET: www.sharppusa.com

PRECAUTIONS TO AVOID POSSIBLE EXPOSURE TO EXCESSIVE MICROWAVE ENERGY

- (a) Do not attempt to operate this oven with the door open since open-door operation can result in harmful exposure to microwave energy. It is important not to defeat or tamper with the safety interlocks.
- (b) Do not place any object between the oven front face and the door or allow soil or cleaner residue to accumulate on sealing surfaces.
- (c) Do not operate the oven if it is damaged. It is particularly important that the oven door close properly and that there is no damage to the: (1) door (bent), (2) hinges and latches (broken or loosened), (3) door seals and sealing surfaces.
- (d) The oven should not be adjusted or repaired by anyone except properly qualified service personnel.

CONSUMER LIMITED WARRANTY

SHARP ELECTRONICS CORPORATION warrants to the first consumer purchaser that this Sharp brand product (the "Product"), when shipped in its original container, will be free from defective workmanship and materials, and agrees that it will, at its option, either repair the defect or replace the defective Product or part thereof with a new or remanufactured equivalent at no charge to the purchaser for parts or labor for the period(s) set forth below.

This warranty does not apply to any appearance items of the Product nor to the additional excluded item(s) set forth below nor to any Product the exterior of which has been damaged or defaced, which has been subjected to improper voltage or other misuse, abnormal service or handling, or which has been altered or modified in design or construction.

In order to enforce the rights under this limited warranty, the purchaser should follow the steps set forth below and provide proof of purchase to the servicer.

The limited warranty described herein is in addition to whatever implied warranties may be granted to purchasers by law. ALL IMPLIED WARRANTIES INCLUDING THE WARRANTIES OF MERCHANTABILITY AND FITNESS FOR USE ARE LIMITED TO THE PERIOD(S) FROM THE DATE OF PURCHASE SET FORTH BELOW. Some states do not allow limitations on how long an implied warranty lasts, so the above limitation may not apply to you.

Neither the sales personnel of the seller nor any other person is authorized to make any warranties other than those described herein, or to extend the duration of any warranties beyond the time period described herein on behalf of Sharp.

The warranties described herein shall be the sole and exclusive warranties granted by Sharp and shall be the sole and exclusive remedy available to the purchaser. Correction of defects, in the manner and for the period of time described herein, shall constitute complete fulfillment of all liabilities and responsibilities of Sharp to the purchaser with respect to the Product, and shall constitute full satisfaction of all claims, whether based on contract, negligence, strict liability or otherwise. In no event shall Sharp be liable, or in any way responsible, for any damages or defects in the Product which were caused by repairs or attempted repairs performed by anyone other than an authorized servicer. Nor shall Sharp be liable or in any way responsible for any incidental or consequential economic or property damage. Some states do not allow the exclusion of incidental or consequential damages, so the above exclusion may not apply to you.

THIS WARRANTY GIVES YOU SPECIFIC LEGAL RIGHTS. YOU MAY ALSO HAVE OTHER RIGHTS WHICH VARY FROM STATE TO STATE.

Your Product Model Number & Description:

R-55TS, Home Use Carousel Microwave Oven. (Be sure to have this information available when you need service for your Product.)

Warranty Period for this Product:

One (1) year parts and labor. The warranty period continues for an additional four (4) years, for a total of five (5) years, with respect to the magnetron tube in the Product for parts only; labor and service are not provided free of charge for this additional period.

Additional Item(s) Excluded from Warranty Coverage (if any):

Non-functional accessories, turntable, turntable support and light bulb.

Where to Obtain Service:

From a Sharp Authorized Servicer located in the United States. To find the location of the nearest Sharp Authorized Servicer, call Sharp toll free at 1-800-BE-SHARP (1-800-237-4277).

What to do to Obtain Service:

Ship prepaid or carry in your Product to a Sharp Authorized Servicer. Be sure to have **Proof of Purchase** available. If you ship the Product, be sure it is insured and packaged securely.

TO OBTAIN SUPPLY, ACCESSORY OR PRODUCT INFORMATION, CALL
1-800-BE-SHARP OR VISIT www.sharpusa.com.

Save the proof of purchase as it is needed should your oven ever require warranty service.

PRODUCT INFORMATION CARD

The product information card which is on the inside of the microwave oven carton should be completed within ten days of purchase and returned. We will keep it on file and help you access the information in case of loss, damage or theft. This will also enable us to contact you in the unlikely event that any adjustments or modifications are ever required for your oven.

IMPORTANT SAFETY INSTRUCTIONS

When using electrical appliances basic safety precautions should be followed, including the following:

WARNING - To reduce the risk of burns, electric shock, fire, injury to persons or exposure to excessive microwave energy:

1. **Read all instructions before using the appliance.**
2. Read and follow the specific **“PRECAUTIONS TO AVOID POSSIBLE EXPOSURE TO EXCESSIVE MICROWAVE ENERGY”** on inside front cover.
3. This appliance must be grounded. Connect only to properly grounded outlet. See **“GROUNDING INSTRUCTIONS”** on page 3.
4. Install or locate this appliance only in accordance with the provided installation instructions.
5. Some products such as whole eggs and sealed containers—for example, closed glass jars—are able to explode and should not be heated in this oven.
6. Use this appliance only for its intended use as described in this manual. Do not use corrosive chemicals or vapors in this appliance. This type of oven is specifically designed to heat, cook or dry food. It is not designed for industrial or laboratory use.
7. As with any appliance, close supervision is necessary when used by children.
8. Do not operate this appliance if it has a damaged cord or plug, if it is not working properly or if it has been damaged or dropped.
9. This appliance should be serviced only by qualified service personnel. Contact nearest Sharp Authorized Servicer for examination, repair or adjustment.
10. Do not cover or block any openings on the appliance.
11. Do not store or use this appliance outdoors. Do not use this product near water—for example, near a kitchen sink, in a wet basement, near a swimming pool or similar locations.
12. Do not immerse cord or plug in water.
13. Keep cord away from heated surfaces.
14. Do not let cord hang over edge of table or counter.
15. See door surface cleaning instructions on page 23.
16. To reduce the risk of fire in the oven cavity:
 - a. Do not overcook food. Carefully attend appliance when paper, plastic or other combustible materials are placed inside the oven to facilitate cooking.
 - b. Remove wire twist-ties from paper or plastic bags before placing bag in oven.
 - c. **If materials inside the oven ignite, keep oven door closed, turn oven off and disconnect the power cord or shut off power at the fuse or circuit breaker panel.**
 - d. Do not use the cavity for storage purposes. Do not leave paper products, cooking utensils or food in the cavity when not in use.
17. Liquids, such as water, coffee or tea are able to be overheated beyond the boiling point without appearing to be boiling. Visible bubbling or boiling when the container is removed from the microwave oven is not always present. **THIS COULD RESULT IN VERY HOT LIQUIDS SUDDENLY BOILING OVER WHEN A SPOON OR OTHER UTENSIL IS INSERTED INTO THE LIQUID.** To reduce the risk of injury to persons:
 - a. Do not overheat the liquid.
 - b. Stir the liquid both before and halfway through heating it.
 - c. Do not use straight-sided containers with narrow necks. Use a wide-mouthed container.
 - d. After heating, allow the container to stand in the microwave oven at least for 20 seconds before removing the container.
 - e. Use extreme care when inserting a spoon or other utensil into the container.
18. If the oven light fails, consult a SHARP AUTHORIZED SERVICER.
19. Oversized foods or oversized metal utensils should not be inserted in this oven as they may create a fire or risk of electric shock.
20. Do not clean with metal scouring pads. Pieces can burn off the pad and touch electrical parts involving a risk of electric shock.
21. Do not use paper products when appliance is operated in the GRILL, BAKE and AUTOMATIC COOKING modes.
22. Do not store any materials, other than manufacture’s recommended accessories, in this oven when not in use.
23. Do not cover any parts of the oven with metal foil. This will cause overheating of the oven.
24. Do not place anything on the top of the oven.

SAVE THESE INSTRUCTIONS

UNPACKING AND INSTALLATION INSTRUCTIONS

Unpacking and Examining Your Oven

Remove:

1. all packing materials from inside the oven cavity; however, **DO NOT REMOVE THE WAVEGUIDE COVER**, which is located on the right cavity wall.

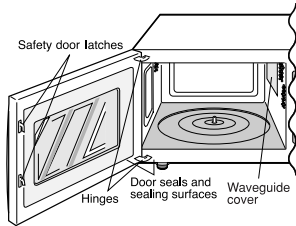

sealing surfaces, broken or loose door hinges and

Read enclosures and **SAVE** the Operation Manual.

2. the feature sticker, if there is one, from the outside of the door.

Check the oven for any damage, such as misaligned or bent door, damaged door seals and

latches and dents inside the cavity or on the door. If there is any damage, do not operate the oven and contact your dealer or SHARP AUTHORIZED SERVICER.

Choosing a Location for Your Oven

You will use the oven frequently so plan its location for ease of use. The oven must be placed on a countertop which is a minimum of 36 inches from the floor. It's wise, if possible, to have counter space on at least one side of the oven. Allow at least 2 inches on the sides, top and at the rear of the oven for air circulation. Do not place or install the oven in any area where heat and steam are generated; for example, next to or above a conventional gas or electric range or above a conventional wall oven. Heat and steam may damage the electronics or the mechanical parts of the oven.

GROUNDING INSTRUCTIONS

This appliance must be grounded. This oven is equipped with a cord having a grounding wire with a grounding plug. It must be plugged into a wall receptacle that is properly installed and grounded in accordance with the National Electrical Code and local codes and ordinances. In the event of an electrical short circuit, grounding reduces risk of electric shock by providing an escape wire for the electric current.

WARNING – Improper use of the grounding plug can result in a risk of electric shock.

Electrical Requirements

The electrical requirements are a 120 volt 60 Hz, AC only, 15 amp. or more protected electrical supply. It is recommended that a separate circuit serving only this appliance be provided.

The oven is equipped with a 3-prong grounding plug. It must be plugged into a wall receptacle that is properly installed and grounded. Should you only have a 2-prong outlet, have a qualified electrician install a correct wall receptacle.

A 3-prong adapter may be purchased and used temporarily if local codes allow. Follow package directions.

A short power-supply cord is provided to reduce risk of becoming entangled in or tripping over a longer cord.

Extension Cord

If it is necessary to use an extension cord, use only a 3-wire extension cord that has a 3-blade grounding plug and a 3-slot receptacle that will accept the plug on the microwave oven. The marked rating of the extension cord should be AC 115-120 volt, 15 amp. or more.

Be careful not to drape the cord over the countertop or table where it can be pulled on by children or tripped over accidentally.

Notes: 1. If you have any questions about the grounding or electrical instructions, consult a qualified electrician or service person.

2. Neither Sharp nor the dealer can accept any liability for damage to the oven or personal injury resulting from failure to observe the correct electrical connection procedures.

Radio or TV Interference

Should there be any interference caused by the microwave oven to your radio or TV, check that the microwave oven is on a different electrical circuit, relocate the radio or TV as far away from the oven as feasible or check position and signal of receiving antenna.

Permanent and Correct Installation

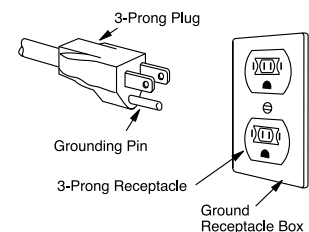

Temporary Use

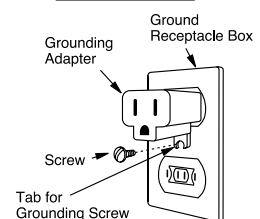

INFORMATION YOU NEED TO KNOW

ABOUT YOUR OVEN

This Operation Manual is valuable: read it carefully and always save it for reference.

Check recipes included in this operation manual as well as this section for cooking principles, techniques and hints.

NEVER use the oven without the turntable and support nor turn the turntable over so that a large dish could be placed in the oven. Only remove for cleaning or for the foods specified in this manual. The turntable will turn both clockwise and counterclockwise.

ALWAYS have food in the oven when it is on to absorb the microwave energy.

When using the oven at power levels below MICRO 100%, you may hear the magnetron cycling on and off. It is normal for the exterior of the oven to be warm to the touch when cooking or reheating.

Condensation is a normal part of microwave cooking. Room humidity and the moisture in food will influence the amount of moisture that condenses in the oven. Generally, covered foods will not have as much condensation as uncovered ones. Vents on the oven back must not be blocked.

After using, the cooling fan may come on to cool the oven cavity. The display will show COOLING, and you will hear the sound of the fan.

Unlike microwave-only ovens, your oven may become hot during cooking. Be cautious.

The oven is for food preparation only. It should not be used to dry clothes or newspapers.

Your oven is rated 650 watts by using the IEC Test Procedure. Check food as it cooks and remove when done.

ABOUT FOOD

FOOD	DO	DON'T
Eggs, sausages, nuts, seeds fruits & vegetables	<ul style="list-style-type: none"> Puncture egg yolks before cooking to prevent "explosion". Pierce skins of potatoes, apples, squash, hot dogs and sausages so that steam escapes. 	<ul style="list-style-type: none"> Cook eggs in shells. Reheat whole eggs. Dry nuts or seeds in shells.
Popcorn	<ul style="list-style-type: none"> Use specially bagged popcorn for the microwave oven. Listen while popping corn for the popping to slow to 1 or 2 seconds or use special POPCORN pad. To pop popcorn using the special POPCORN pad, place a pie plate on the turntable. Then place a bag on the pie plate. Place carefully so bag does not touch oven walls. The corners of the bag may be folded down. 	<ul style="list-style-type: none"> Pop popcorn in regular brown bags or glass bowls. Exceed maximum time on popcorn package.
Baby food	<ul style="list-style-type: none"> Transfer baby food to small dish and heat carefully, stirring often. Check temperature before serving. Put nipples on bottles after heating and shake thoroughly. "Wrist" test before feeding. 	<ul style="list-style-type: none"> Heat baby food in original jars. Heat disposable bottles. Heat bottles with nipples on.
General	<ul style="list-style-type: none"> Cut baked goods with filling after heating to release steam and avoid burns. Stir liquids briskly before heating and allow to stand at least for 20 seconds after heating before stirring or drinking to avoid eruption. Use deep bowl, when cooking liquids or cereals, to prevent boilovers. 	<ul style="list-style-type: none"> Heat or cook in closed glass jars or air tight containers. Can in the microwave as harmful bacteria may not be destroyed. Deep fat fry. Dry wood, gourds, herbs or wet papers.

INFORMATION YOU NEED TO KNOW

ABOUT UTENSILS AND COVERINGS

It is not necessary to buy all new cookware. Many pieces already in your kitchen can be used successfully in your new toaster oven with microwave. The chart below will help you decide what utensils and coverings should be used in each mode.

Utensils and Coverings	Microwave Only	Grill, Bake
Aluminum foil	<input checked="" type="checkbox"/> Yes Small flat pieces of aluminum foil placed smoothly on food can be used to shield areas from cooking or defrosting too quickly. Keep foil at least 1 inch from walls of oven. Be sure foil does not touch the turntable.	<input checked="" type="checkbox"/> Yes
Aluminum containers	<input checked="" type="checkbox"/> Yes Can be used if 3/4 filled with food. Keep 1 inch away from walls and do not cover with foil.	<input checked="" type="checkbox"/> Yes
Glass ceramic (Pyroceram. ®)	<input checked="" type="checkbox"/> Yes Excellent	<input checked="" type="checkbox"/> Yes Excellent
Glass, heat-resistant	<input checked="" type="checkbox"/> Yes Excellent. A pie plate is necessary for popping popcorn.	<input checked="" type="checkbox"/> Yes Excellent
Glass, non-heat-resistant	<input type="checkbox"/> No	<input type="checkbox"/> No
Lids, glass	<input checked="" type="checkbox"/> Yes Excellent	<input checked="" type="checkbox"/> Yes
Lids, metal	<input type="checkbox"/> No	<input type="checkbox"/> No
Metal cookware	<input type="checkbox"/> No	<input checked="" type="checkbox"/> Yes
Metal, misc: dishes with metallic trim, screws, bands, handles. Metal twist ties	<input type="checkbox"/> No	<input type="checkbox"/> No
Oven cooking bags	<input checked="" type="checkbox"/> Yes Good for meats or foods that need tenderizing. DO NOT use metal twist ties.	<input checked="" type="checkbox"/> Yes
Paper plates	<input checked="" type="checkbox"/> Yes For reheating	<input type="checkbox"/> No
Paper towels	<input checked="" type="checkbox"/> Yes To cover for reheating and cooking. Do not use recycled paper towels which may contain metal filings.	<input type="checkbox"/> No
Microwave-safe plastic containers	<input checked="" type="checkbox"/> Yes Use for reheating and defrosting. Some plastics are not suitable for cooking foods with high fat and sugar content. Follow manufacturer's directions.	<input type="checkbox"/> No
Plastic wrap	<input checked="" type="checkbox"/> Yes Use brands specially marked for microwave use. DO NOT allow plastic wrap to touch food. Vent so steam can escape.	<input type="checkbox"/> No

INFORMATION YOU NEED TO KNOW

Utensils and Coverings	Microwave Only	Grill, Bake
Pottery, porcelain stoneware	<input type="checkbox"/> Yes Check manufacturer's recommendation for being microwave-safe.	<input type="checkbox"/> Yes
Styrofoam	<input type="checkbox"/> Yes For reheating	<input type="checkbox"/> No
Wicker, wood, straw	<input type="checkbox"/> Yes May be used for short periods of time. Do not use with high fat or high sugar content foods. Could char.	<input type="checkbox"/> No

DISH CHECK. If you wish to check if a dish is safe for microwaving, place the empty dish in the oven and microwave on HIGH (100%) for 30 seconds. If the dish becomes very hot, do NOT use it for microwaving.

AUTOMATIC COOKING. Use the recommended container in the cooking chart in this operation manual.

ACCESSORIES. There are many microwave accessories available for purchase. Evaluate carefully before you purchase so that they meet your needs. A microwave-safe thermometer will assist you in determining correct doneness and assure you that foods have been cooked to safe temperatures when using microwave-only cooking. Sharp is not responsible for any damage to the oven when accessories are used.

INFORMATION YOU NEED TO KNOW

ABOUT MICROWAVE COOKING

- Arrange food carefully. Place thickest areas towards outside of dish.
- Watch cooking time. Cook for the shortest amount of time indicated and add more as needed. Food severely overcooked can smoke or ignite.
- Cover foods while cooking. Check recipe or cookbook for suggestions: paper towels, wax paper, microwave plastic wrap or a lid. Covers prevent spattering and help foods to cook evenly.
- Shield with small flat pieces of aluminum foil any thin areas of meat or poultry to prevent overcooking before dense, thick areas are cooked thoroughly.
- Stir foods from outside to center of dish once or twice during cooking, if possible.
- Turn foods over once during microwaving to speed cooking of such foods as chicken and hamburgers. Large items like roasts must be turned over at least once.
- Rearrange foods such as meatballs halfway through cooking both from top to bottom and from the center of the dish to the outside.
- Add standing time. Remove food from oven and stir, if possible. Cover for standing time which allows the food to finish cooking without overcooking.
- Check for doneness. Look for signs indicating that cooking temperatures have been reached.
 - Doneness signs include:**
 - Food steams throughout, not just at edge.
 - Center bottom of dish is very hot to the touch.
 - Poultry thigh joints move easily.
 - Meat and poultry show no pinkness.
 - Fish is opaque and flakes easily with a fork.
- After cooking, accessories and dishes may be hot. Be careful when removing food.

ABOUT SAFETY

- Check foods to see that they are cooked to the United States Department of Agriculture's recommended temperatures.

TEMP	FOOD
160°F	... for fresh pork, ground meat, boneless white poultry, fish, seafood, egg dishes and frozen prepared food.
165°F	... for leftover, ready-to-reheat refrigerated, and deli and carry-out "fresh" food.
170°F	... white meat of poultry.
180°F	... dark meat of poultry.

To test for doneness, insert a meat thermometer in a thick or dense area away from fat or bone. NEVER leave the thermometer in the food during cooking, unless using a microwave thermometer when cooking with only microwave power.

ABOUT CHILDREN AND THE MICROWAVE

Children below the age of 7 should use the microwave oven with a supervising person very near to them. Between the ages of 7 and 12, the supervising person should be in the same room.

The child must be able to reach the oven comfortably; if not, he/she should stand on a sturdy stool.

At no time should anyone be allowed to lean or swing on the oven door.

- ALWAYS use potholders to prevent burns when handling utensils that are in contact with hot food. Enough heat from the food can transfer through utensils to cause skin burns.
- Avoid steam burns by directing steam away from the face and hands. Slowly lift the farthest edge of a dish's covering and carefully open popcorn and oven cooking bags away from the face.
- Stay near the oven while it's in use and check cooking progress frequently so that there is no chance of overcooking food.
- NEVER use the cavity for storing cookbooks or other items.
- Select, store and handle food carefully to preserve its high quality and minimize the spread of foodborne bacteria.
- Keep waveguide cover clean. Food residue can cause arcing and/or fires.
- Use care when removing items from the oven so that the utensil, your clothes or accessories do not touch the safety door latches.

Children should be taught all safety precautions: use potholders, remove coverings carefully, pay special attention to packages that crisp food because they may be extra hot.

Don't assume that because a child has mastered one cooking skill he/she can cook everything.

Children need to learn that this oven is not a toy. See page 22 for Child Lock feature.

ABOUT GRILL, BAKE AND AUTOMATIC COOKING

- The oven cabinet, cavity, door, accessories and dishes will become hot. To PREVENT BURNS, use thick oven gloves when removing the food or turntable from the oven.
- We recommend leaving the turntable in the oven during preheating unless it will be used as the baking pan, such as with biscuits. When preheat is over, open oven door and quickly place foods to be baked inside.
- Do not cover turntable with aluminum foil.

PART NAMES

OVEN PARTS

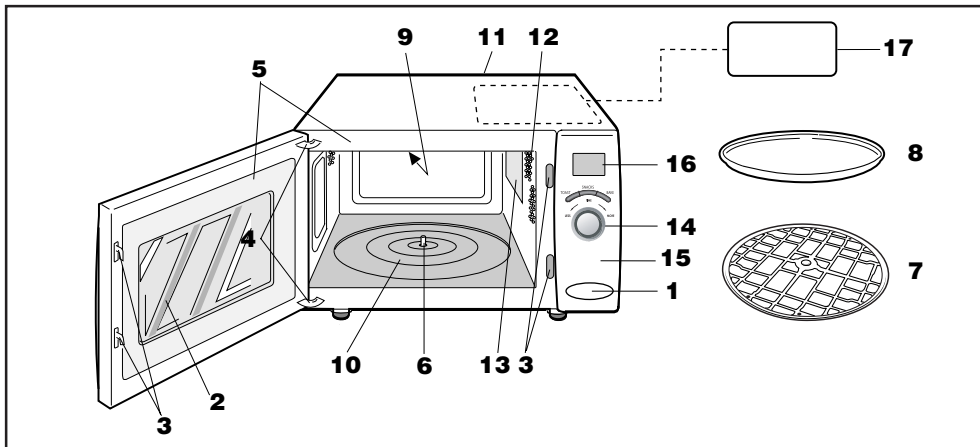

- | | |
|---|--|
| <p>1 Door opening button
Push to open door.</p> <p>2 Oven door with see-through window</p> <p>3 Safety door latches
The oven will not operate unless the door is securely closed.</p> <p>4 Door hinges</p> <p>5 Door seals and sealing surfaces</p> <p>6 Turntable motor shaft</p> <p>7 Removable turntable support
Carefully place the turntable support on the turntable motor shaft(6) in the center of the oven floor.</p> <p>8 Removable turntable
Place the turntable securely on the turntable support. The turntable will rotate clockwise or counterclockwise. Only remove for cleaning or for the foods specified in this manual.</p> | <p>9 Top grill heater (top heater)</p> <p>10 Bottom grill heater (bottom heater)
The bottom heater is under the cavity floor.</p> <p>11 Ventilation openings (rear)</p> <p>12 Oven light
It will light when oven is operating or door is open.</p> <p>13 Waveguide cover: DO NOT REMOVE.</p> <p>14 Rotary dial</p> <p>15 Control panel</p> <p>16 Time display: 95 minutes</p> <p>17 Food label
The food label in English and in Spanish is packed in the oven. Attach the selected one to the oven top.</p> |
|---|--|

DISPLAY

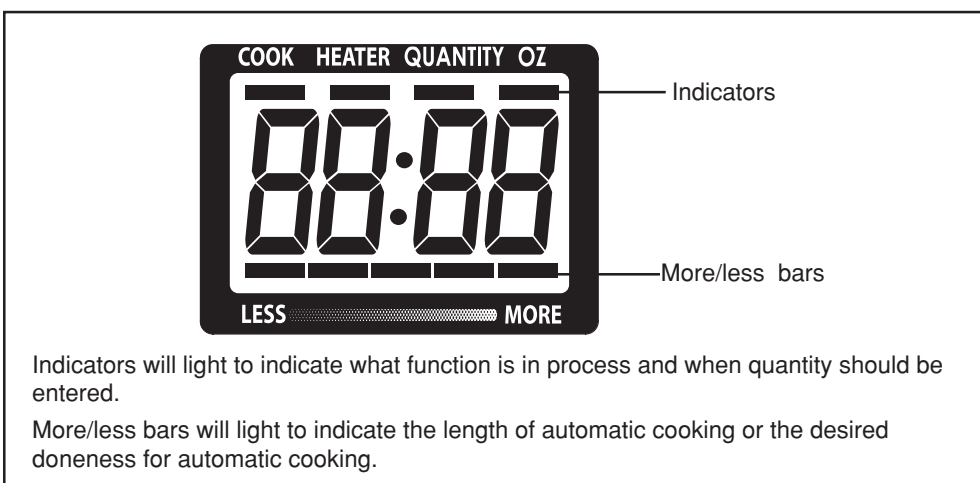

R-55TS

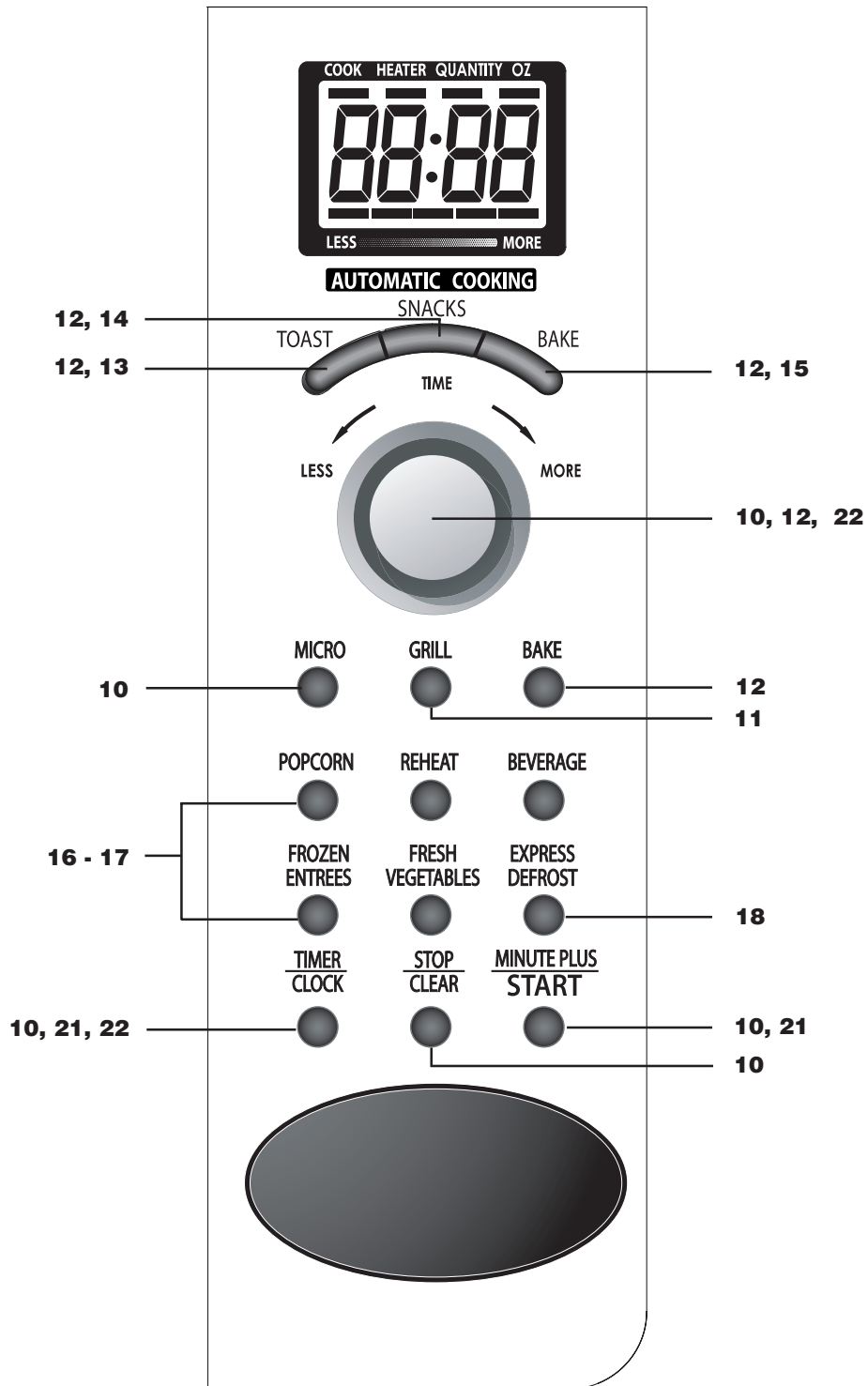







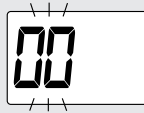

Number next to the control panel illustration indicates page on which there are a feature description and usage information.

BEFORE OPERATING

- Before operating your new toaster oven with microwave make sure you read and understand this operation manual completely.
- Before the oven can be used, follow these procedures:
 1. Plug in the oven. Close the door. The oven display will begin flashing **88:88**.
 2. Touch **STOP/CLEAR**. **:** will appear.
 3. Set clock. See below.
 4. Condition the heaters by heating oven without food. See page 11.

TO SET THE CLOCK

- Suppose you want to enter the correct time of day 12:30 (A.M. or P.M.).

PROCEDURE	DISPLAY
1  Touch CLOCK .	 00 (hour) will flash.
2  Enter the correct hour by rotating the rotary dial.	
3  Touch CLOCK again.	 00 (minute) will flash.
4  Enter the correct minute by rotating the rotary dial.	
5  Touch CLOCK again.	

- If the electrical power supply to your microwave oven should be interrupted, the display will intermittently show **88:88** after the power is reinstated. If this occurs during cooking, the program will be erased. The time of day will also be erased. Simply touch **STOP/CLEAR** and reset the clock for the correct time of day.

STOP/CLEAR

Touch **STOP/CLEAR** to:

1. Erase if you make a mistake during programming.
2. Cancel timer.
3. Stop the oven temporarily during cooking.
4. Return the time of day to the display.
5. Cancel a program during cooking, touch twice.

MANUAL OPERATION





MICROWAVE TIME COOKING

Your oven can be programmed for 95 minutes (95.00) using the rotary dial. The increments for time entry vary from 10 seconds to 5 minutes, depending on the total length of the cooking /defrosting time as shown in the table below:

Cooking Time	Time Increments
0-5 minutes	10 seconds
5-10 seconds	30 seconds
10-30 minutes	1 minute
30-95 minutes	5 minutes

You can turn the rotary dial clockwise or counter-clockwise. If you turn it counter-clockwise, the cooking time will decrease from 95 minutes.

- Suppose you want to cook for 5 minutes at 100%.





PROCEDURE	DISPLAY
1  Enter cooking time.	
2  Touch START .	

TO SET POWER LEVEL

There are six preset power levels. Using lower power levels increases the cooking time, which is recommended for foods such as cheese, milk and long slow cooking of meats. Consult cookbook or recipes for specific recommendations.

Touch MICRO	Approximate Percentage of Power	Common Words for Power Level
once	100%	High
twice	70%	Medium High
3 times	50%	Medium
4 times	30%	Med Low/Defrost
5 times	10%	Low
6 times	0%	

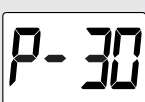
- Suppose you want to defrost for 5 minutes at 30%.

PROCEDURE	DISPLAY
1  Enter defrost time.	
2  Touch MICRO 4 times or hold down until the desired power level appears.	
3  Touch START .	
4 When the defrost time is complete, a long tone will sound and End will appear in the display.	





You can program up to 3 cooking sequences.

Follow directions on page 21. Note that the power level must be entered first when programming multiple sequences.

MANUAL OPERATION

CONDITION THE HEATERS

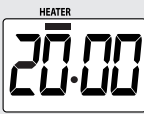
Condition the oven before cooking in it for the first time to eliminate any smoke or burning odor. To condition, follow procedure below with nothing in the oven. Operate both top and bottom heaters without food for 20 minutes.

PROCEDURE	DISPLAY
1 GRILL  x 2 Touch GRILL twice.	
2  Enter cooking time.	
3 MINUTE PLUS START  Touch START .	
4 The oven will count down. When the oven has finished cooking, open the door to cool the oven cavity.	

NOTE:

When conditioning the heaters, be sure that the room is ventilated well by opening a window or using a circulating fan.

CAUTION:



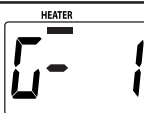
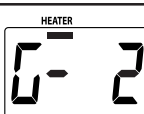

The oven cabinet, cavity, door, turntable and turntable support will become hot.

GRILL

Use the GRILL setting for steaks, chops, chicken pieces and many other foods. Your oven has 2 grill heaters and 2 grill cooking options. Select the desired options by touching **GRILL**. See chart below. You can enter cooking time up to 30 minutes.

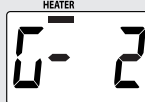
Option	Touch GRILL	Cooking method	Display
GRILL 1	Once	Top heater	
GRILL 2	Twice	Top and bottom heaters	

- Suppose you want to grill a steak for 15 minutes on GRILL 2 (Top and bottom heaters)

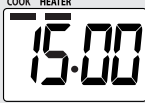
PROCEDURE	DISPLAY
1 GRILL  x 2 Touch GRILL twice.	
2  Enter cooking time.	
3 MINUTE PLUS START  Touch START .	

HINT:

Turning food over at two-thirds of the cooking time is recommended.

NOTE:

- After cooking is complete, the cooling fan will continue for a short time to lower the temperature of the oven.

CAUTION:

The oven cabinet, cavity, door, turntable, turntable support and dishes will become hot. To PREVENT BURNS, use thick oven gloves when removing the food or turntable.

MANUAL OPERATION

BAKE

Use the BAKE setting for cakes, breads and many other foods. This oven has 4 pre-set oven temperatures which use a combination of the top and bottom heaters. The BAKE is preprogrammed to include preheating.

Touch BAKE	Once	Twice	3 times	4 times
Oven Temperature (° F)	400	375	350	325

We recommend leaving the turntable in the oven during preheating unless it will be used as the baking pan, such as with biscuits.

* Suppose you want to bake a cake for 25 minutes at 350° F.

PROCEDURE	DISPLAY
1 BAKE x 3 Touch BAKE 3 times.	
2 Enter cooking time.	
3 MINUTE PLUS START Touch START . Preheat starts. No food in oven.	
When the oven reaches the programmed temperature, a signal will sound 4 times and the oven will display 350F.*	
4 Open the door. Place food in the oven. Close the door. Touch START .	

* If the oven door is not opened, the oven will automatically hold at the preheat temperature for 30 minutes. After this time has elapsed, an audible signal will sound and the oven will turn off.

NOTE:

- Touching **BAKE** during cooking will display the programmed temperature. It will not affect the program or cooking time.
- The oven regulates the oven temperature by turning the top and bottom heaters on and off. Though the actual oven temperature may differ from the set temperature, simply set the desired oven temperature by touching **BAKE**. Follow the operation manual, recipes and package suggestions carefully. Do not use an oven thermometer.
- After cooking is complete, the cooling fan will continue for a short time to lower the temperature.

CAUTION:

The oven cabinet, cavity, door, turntable, turntable support and dishes will become hot. To PREVENT BURNS, use thick oven gloves when removing the food or turntable.

SPECIAL FEATURES

AUTOMATIC COOKING

Your oven has 3 special features:

- AUTOMATIC TOAST
- AUTOMATIC SNACK
- AUTOMATIC BAKE

The **AUTOMATIC COOKING** features have both the ideal heater settings and the ideal cooking times preprogrammed. 5 popular foods are included in each feature. To select a food, touch desired AUTOMATIC COOKING feature until the desired food number appears in the display.

Each food has 5 different time settings. They are shown as the number of the More/Less bars in the display. The 3 More/Less bar setting is programmed as the original setting. You can choose desired time setting with the rotary dial. Refer to each AUTOMATIC COOKING charts on pages 13 - 15.

CAUTION:

The oven cabinet, cavity, door, turntable, turntable support and dishes will become hot. To PREVENT BURNS, use thick oven gloves when removing the food or turntable.

Example:

* Suppose you want to toast 2 frozen waffles.

PROCEDURE	DISPLAY
1 TOAST x 3 Select desired food by touching AUTOMATIC TOAST. Ex: Touch 3 times for waffles.	
2 Select desired setting by rotating the rotary dial. Ex: Select 5 bars for 2 frozen waffles.	
3 MINUTE PLUS START Touch START .	

SPECIAL FEATURES

AUTOMATIC TOAST CHART

FOOD			PROCEDURE
AT-1 Bread			Remove the turntable from the oven. Place food directly around the center of the turntable support but not on the exact center. NOTE: Cooking time is adjusted by initial oven temperature. After touching START, the oven will show AT-1, for the first 10 seconds, to check the initial temperature.
Number of Bars	Cooking Time	Recommended Quantity	
1	3 min. 40 sec.	1 - 4 slices	
2	4 min.		
3	4 min. 20 sec.		
4	4 min. 40 sec.		
5	5 min.		
AT-2 Bagels			Remove the turntable from the oven. Place food directly on turntable support. Put cut side of bagel up.
Number of Bars	Cooking Time	Recommended Quantity	
1	4min.	1 half	
2	4 min. 15 sec.	2 halves	
3	4 min. 30 sec.		
4	4 min. 50 sec.		
5	5 min. 20sec.		
AT-3 Waffles			Remove the turntable from the oven. Place food directly on turntable support.
Number of Bars	Cooking Time	Recommended Quantity	
1	5 min.	1 room temp. or frozen waffle	
2	5 min. 30 sec.	2 room temp. waffles	
3	6 min.		
4	6 min. 30 sec.		
5	7 min.		
AT-4 French Toast			Remove the turntable from the oven. Place food directly on turntable support. If sticks are very greasy, place a flat piece of foil on the turntable support with sticks on top to prevent grease from falling on to the oven floor.
Number of Bars	Cooking Time	Recommended Quantity	
1	7 min.	3-6 sticks	
2	7 min. 20 sec.	1-2 slices	
3	8 min.		
4	8 min. 20 sec.		
5	8 min. 40 sec.		
AT-5 Toaster Pastries			Remove the turntable from the oven. Place food directly on turntable support.
Number of Bars	Cooking Time	Recommended Quantity	
1	3 min.	1-2 room temp. pastries	
2	3 min. 15 sec.		
3	3 min. 30 sec.		
4	4 min.		
5	6 min.		

Special note for AUTOMATIC TOAST:

Place items to be toasted directly on the turntable support. Do not use the turntable for the AUTOMATIC TOAST foods.

SPECIAL FEATURES

AUTOMATIC SNACK CHART

FOOD			PROCEDURE
AS-1 French Fries			Cook directly on turntable. Can spray with cooking spray to make clean-up easier.
Number of Bars	Cooking Time	Recommended Quantity	
1	15 min. 30 sec.	1/2 pound French fries	
2	16 min. 30 sec.		
3	17 min. 30 sec.		
4	18 min.		
5	18 min. 30 sec.		
AS-2 Frozen Pizza			Cook directly on turntable. Can spray with cooking spray to make clean-up easier.
Number of Bars	Cooking Time	Recommended Quantity	
1	13 min.	5-7 oz frozen pizza	
2	14 min.		
3	15 min.		
4	16 min.		
5	20 min.	14 oz frozen pizza	
AS-3 Hamburgers			Cook directly on turntable. Can spray with cooking spray to make clean-up easier.
Number of Bars	Cooking Time	Recommended Quantity	
1	15 min.	1 medium	
2	16 min.	2 medium 1 well done	
3	18 min.	3 medium	
4	20 min.	4 medium 3 well done	
5	21 min.	4 well done	
AS-4 Frozen Appetizers			Cook directly on turntable. Can spray with cooking spray to make clean-up easier.
Number of Bars	Cooking Time	Recommended Quantity	
1	7 min.	4 - 8 pieces	
2	7 min. 30 sec.		
3	8 min.		
4	9 min.		
5	10 min.		
AS-5 Hot Dogs and Sausage			Cook directly on turntable. Can spray with cooking spray to make clean-up easier.
Number of Bars	Cooking Time	Recommended Quantity	
1	8 min.	1-2 pieces	
2	8 min. 30 sec.	3-4 pieces	
3	9 min.		
4	9 min. 30 sec.		
5	10 min.		

SPECIAL FEATURES

AUTOMATIC BAKE CHART



MENU			PROCEDURE
AB-1 Baked Potatoes			Grease skin with butter or shortening.
Number of Bars	Cooking Time	Recommended Quantity	
1	14 min.	1 medium	
2	16 min.		
3	17 min.	2 medium	
4	18 min.		
5	20 min.		
AB-2 Biscuits			Preheat is preprogrammed for this food. ADD FOOD AFTER PREHEATING. Bake directly on turntable.
Number of Bars	Cooking Time	Recommended Quantity	
1	8 min.		
2	9 min.	Convenience refrigerated baked at 400 or 450°F	
3	10 min.	Home made	
4	11 min.	Convenience frozen	
5	12 min.		
AB-3 Muffins			Preheat is preprogrammed for this food. ADD FOOD AFTER PREHEATING. Use 6-cup muffin pan. Be sure to check that it turns freely.
Number of Bars	Cooking Time	Recommended Quantity	
1	14 min.		
2	15 min.		
3	16 min.	6-cup pan	
4	17 min.		
5	18 min.		
AB-4 Brownies			Preheat is preprogrammed for this food. ADD FOOD AFTER PREHEATING. Can use disposable foil pan. Bend corners under slightly so pan will turn freely.
Number of Bars	Cooking Time	Recommended Quantity	
1	28 min.		
2	29 min.		
3	30 min.	8-inch pan	
4	31 min.		
5	32 min.		
AB-5 Cakes			Preheat is preprogrammed for this food. ADD FOOD AFTER PREHEATING. Can use disposable foil pan. Bend corners under slightly so pan will turn freely.
Number of Bars	Cooking Time	Recommended Quantity	
1	25 min.	6 cupcakes	
2	28 min.		
3	30 min.	8 or 9-inch pan	
4	32 min.		
5	34 min.		

SPECIAL FEATURES

MICROWAVE OPTIONS

Microwave options allow you to cook or reheat many of your favorite foods by touching just one pad.

- Suppose you want to reheat 1 cup of beverage.

PROCEDURE	
<p>1 Select desired setting. Touch BEVERAGE 2 times or hold down until the desired quantity appears.</p>	 x 2
<p>2 Touch START.</p>	

NOTE:

1. To increase quantity, touch chosen pad until number in display is same as desired quantity.

Ex: touch **FRESH VEGETABLES** pad twice for 2 cups of fresh vegetables. More or less food than the quantity listed in the chart should be cooked following the guidelines in any microwave cookbook.

2. Microwave options can be programmed with More or Less Time Adjustment. See page 22.
3. The final cooking result will vary according to the food condition (e.g. initial temperature, shape, quality). Check food for temperature after cooking. If additional time is needed, continue to cook manually.
4. After cooking is complete, the cooling fan may continue for a short time to lower the temperature.

MICROWAVE OPTIONS CHART

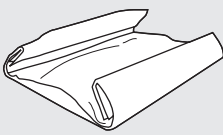
FOOD	AMOUNT	PROCEDURE
	1 bag	Try several brands to decide which is most acceptable for your taste. Place a pie plate on the turntable. Place bag with only one fold slightly off center and place bag with two folds in the center of the pie plate. You should fold down the corners of the bag like the illustration so it turns freely. After popping, the pie plate, turntable and turntable support will be hot. Be careful when removing the bag.
	3.5 oz bag (Regular)	Touch POPCORN once for regular. <input type="text" value="1"/> .
	2.85 - 3.5 oz bag (Regular Light)	Touch POPCORN twice for regular light. <input type="text" value="2"/> .
	1.5 - 1.75 oz bag	Touch POPCORN three times for snack. <input type="text" value="3"/> .
REHEAT:		
Casserole	1 - 2 cups	Use to reheat refrigerated canned or homemade pasta with sauce or other cooked casserole. For room temperature pasta or casserole, use Less option. For pasta without sauce double the quantity per setting. For example, measure 2 cups of cooked noodles and program for 1 cup. Cover with lid or plastic wrap. After cooking, stir and let stand, covered, 2 to 3 minutes.
	1 cup	Touch REHEAT once, <input type="text" value="1"/> will appear in the display.
	2 cups	Touch REHEAT twice, <input type="text" value="2"/> will appear in the display.
Dinner Plate	1 plate	Use to reheat precooked foods from the refrigerator. Place meaty portions and bulky vegetables to outside of plate. Cut large items like baked potatoes in smaller pieces. Flatten foods such as mashed potatoes and other dense foods. Cover with lid or plastic wrap. ONE PLATE ONLY. After cooking, check that food is very hot throughout and that the bottom center of the plate is very hot. If not, continue heating using time and power level. Allow to stand, covered, 1 to 2 minutes.
	1 Small	Touch REHEAT once for a smaller amount of food on a dinner plate. <input type="text" value="1"/> will appear in the display.
	1 Regular	Touch REHEAT twice for a regular amount of food on a dinner plate. <input type="text" value="2"/> will appear in the display.

SPECIAL FEATURES

MICROWAVE OPTIONS CHART (continued)

FOOD	AMOUNT	PROCEDURE
BEVERAGE	.5 - 2 cups	This setting is good for restoring cooled beverage to a better drinking temperature. Stir liquid briskly before and after heating to avoid "eruption". You can reheat .5 cup, 1 cup, 1.5 cups and 2 cups by touching BEVERAGE .
Frozen Entrees	3-10 oz.	Use for frozen, convenience foods. It will give satisfactory results for most brands. You may wish to try several and choose your favorite. Remove package from outer wrapping and follow package directions for covering. After cooking, let stand, covered, for 1 to 3 minutes.
	3-6 oz.	Touch FROZEN ENTREES once for packages weighing 3-6 oz. <input type="text" value="3-6"/> will appear in the display.
	7-10 oz.	Touch FROZEN ENTREES twice for packages weighing 7-10 oz. <input type="text" value="7-10"/> will appear in the display.
Fresh Vegetables	1- 2 cups	For beans, carrots, corn and peas, add 1 tablespoon of water per cup. For broccoli, Brussels sprouts, cabbage and cauliflower, cook immediately after washing with no additional water. Cover with a glass lid. If you like tender crisp vegetables, double measured quantity per setting. For example, use 2 cups of zucchini but touch FRESH VEGETABLES only once. After cooking, remove from oven, stir, cover and let stand 3 to 5 minutes before serving.

SPECIAL FEATURES

EXPRESS DEFROST

Express Defrost automatically defrosts all the foods shown in the EXPRESS DEFROST CHART below.





You can defrost .5 lb, .7 lb, 1.0 lb, 1.3 lb, 1.5 lb, 1.7 lb and 2.0 lb by touching **EXPRESS DEFROST**.

Ex: touch twice for .7 lb.

- Suppose you want to defrost a 2.0 pound steak.

NOTE:

1. Express Defrost can be programmed with More or Less Time Adjustment. See page 22.
2. To defrost other foods or foods above or below the weights allowed in the EXPRESS DEFROST CHART, use time and 30% power. See MANUAL DEFROST on page 19.

PROCEDURE	
<p>1 Enter desired weight by touching EXPRESS DEFROST. Ex: Touch 7 times for 2.0 lb.</p>	<p>EXPRESS DEFROST</p>  x 7
<p>2 Touch START.</p>	<p>MINUTE PLUS START</p> 
<p>3 After the 1st stage, open the door, turn steak over and shield any warm portions. Close the door.</p> <p>Touch START.</p>	<p>MINUTE PLUS START</p> 
<p>4 After the 2nd stage, open the door and shield any warm portions. Close the door.</p> <p>Touch START.</p>	<p>MINUTE PLUS START</p> 
<p>5 After the defrost cycle ends, cover and let stand as indicated in chart below.</p>	

EXPRESS DEFROST CHART

FOOD	AMOUNT	PROCEDURE
Ground Meat	.5 - 2.0 lb	Pull apart and remove any thawed pieces after each stage. Let stand, covered, for 5 to 10 minutes.
Steaks/Chops	.5 - 2.0 lb	After each stage, rearrange and if there are warm or thawed portions, shield with small flat pieces of aluminum foil. Remove any meat that is nearly defrosted. Let stand, covered, for 10 to 20 minutes.
Boneless Poultry	.5 - 1.5 lb	Use boneless breast of chicken or turkey. After each stage, if there are warm or thawed portions, rearrange or remove. Let stand, covered, for 10 to 20 minutes.
Bone-in Poultry	.5 - 2.0 lb	Arrange pieces with meatiest portions toward outside of glass dish or microwave safe rack. After each stage, if there are warm or thawed portions, rearrange or remove. Let stand, covered, for 10 to 20 minutes.

NOTE: Check foods when oven signals. After final stage, small sections may still be icy. Let stand to continue thawing. Do not defrost until all ice crystals are thawed.

Shielding prevents cooking from occurring before the center of the food is defrosted. Use small smooth strips of aluminum foil to cover edges and thinner sections of the food.

SPECIAL FEATURES

MANUAL DEFROST

If the food that you wish to defrost is not listed on the EXPRESS DEFROST CHART or is above or below the limits in the "Amount" column on the EXPRESS DEFROST CHART, you will need to defrost manually.

You can defrost any frozen food, either raw or previously cooked, by using MICRO 30% Power Level. See page 10. Estimate defrosting time and press MICRO 4 times for 30% when you select the power level.

For either raw or previously cooked frozen food the rule of thumb is approximately 5 minutes per pound. For example, defrost 5 minutes for 1 pound of frozen spaghetti sauce.

Always stop the oven periodically to remove or separate the portions that are defrosted. If food is not defrosted at the end of the estimated defrosting time, program the oven in 1 minute increments at 30% until totally defrosted.

When using plastic containers from the freezer, defrost only long enough to remove from the plastic in order to place in a microwave-safe dish.

RECIPES

DINNER FOR TWO USING THE WARM AND TOASTY OVEN

Fresh Strawberry Shortbread Dessert

- 1/3 cup all-purpose flour
- 2 tablespoons cornstarch
- 1/4 teaspoon baking powder
- 5 tablespoons unsalted butter
- 1/4 cup sugar
- 1 tablespoon packed brown sugar
- 1 teaspoon vanilla
- 1/2 teaspoon grated fresh orange peel
- 1/4 cup strawberry jelly
- 10 small strawberries with stems removed

Make shortbread a few hours before serving time.

Sift flour, cornstarch, baking powder and salt together. Place butter, sugar, vanilla and orange peel into large bowl and beat with an electric mixer until fluffy. Add flour mixture and beat just until moist clumps form. Gather dough into ball and flatten into round circle. Wrap in plastic wrap and refrigerate until just firm.

Remove turntable from oven. Touch **BAKE** 4 times to preheat to 325 F. and enter 15 minutes.

Cut a circle of wax paper to fit into the turntable. Place shortbread dough on lightly floured surface and roll with floured rolling pin into a circle 1/4-inch thick. Using 3-inch cookie cutter, cut dough into 4 shortbreads. Place on wax paper lined turntable and bake in preheated oven until lightly browned. Remove from oven and allow to stand 2 minutes for shortbreads to become firm. Remove from turntable and allow to cool completely.

At serving time, microwave strawberry jelly for 1 minute at MICRO HIGH (100%) or until melted but not hot. Stir. Place 2 shortbreads on each dessert plate. Top with 5 strawberries, bottom side up, and then drizzle melted jelly on strawberries. Serve topped with whipped cream, if desired.

RECIPES

Italian Portabello Appetizers

- | | |
|--|--|
| 1 cup sweet Italian sausage meat, about 6 ounces | 1/4 cup dry Italian bread crumbs |
| 3 tablespoons chopped bell pepper | 1/4 cup shredded Romano cheese |
| 3 tablespoons chopped red onion | 2 Portobello mushrooms (4 1/2-inch diameter) |
| 2 cloves garlic, chopped | 2 tablespoons olive oil |
| 2 shredded basil leaves | |

Combine sausage, bell pepper, onion, garlic and basil in a 2-quart casserole. Cover and cook at MICRO HIGH (100%) for 14 minutes. Break up large sausage pieces, add bread crumbs and cheese and stir well. Set aside.

Touch **BAKE** 2 times to preheat to 375 F. and enter 20 minutes.

Remove stems from mushrooms and use elsewhere. Wipe remaining mushrooms with a damp cloth being sure to remove any traces of dirt or debris. Rub mushrooms on both sides with olive oil. Stuff mushrooms with sausage mixture. Place on turntable and bake in the preheated oven.

The appetizers can be prepared ahead and refrigerated until serving time. To reheat, place stuffed mushrooms on serving plate and cover lightly with wax paper. Touch **REHEAT** once.

Super Potato Supper

- | | |
|--|---|
| 1/2 pound boneless pork loin, 1/2"- 3/4" thick | 1/2 cup grated Swiss cheese |
| 2 baking potatoes, 8-ounces each | 1/4 bell pepper, cut into 8 thin strips |
| 2 teaspoons butter | 3 tablespoons chopped onion |

Season pork loin with salt and pepper and place on turntable. Touch **GRILL** twice and enter 8 minutes. At end of grilling time, remove pork and clean turntable. Cut pork into thin strips and set aside.

Pierce baking potatoes in several places and put on the turntable. Touch **AUTOMATIC BAKE** once and see that the dial is set at the third bar, which is for 2 potatoes. At end, remove potatoes, cut lengthwise about 1-inch deep. Put 1 teaspoon of butter and half of the pork strips, cheese, pepper and onions in each potato. Place on turntable in oven. Touch **GRILL** once and enter 10 minutes.

OTHER CONVENIENT FEATURES

MULTIPLE SEQUENCE COOKING

Your oven can be programmed for up to 3 cooking sequences, switching from one power level setting or other option to another automatically.

Sometimes cooking directions tell you to start on one power level and then change to a different power level. Your oven can do this automatically.

- Suppose you want to cook for 5 minutes at MICRO 70% and then continue to cook for 10 minutes on GRILL1.

PROCEDURE	
<p>1 First touch MICRO twice for 70% power.</p> <p>Then enter cooking time.</p>	
<p>2 Touch GRILL once for GRILL1.</p> <p>Then enter second cooking time.</p>	
<p>3 Touch START.</p>	

NOTE:

1. You can program BAKE for the first sequence only.
2. If you wish to know the power level, simply touch **MICRO**. As long as your finger is touching **MICRO**, the power level will be displayed.

MINUTE PLUS

Minute Plus allows you to microwave for a minute at MICRO HIGH (100%) by simply touching **MINUTE PLUS**. You can also extend cooking time in multiples of 1 minute by repeatedly touching **MINUTE PLUS** during manual cooking.

- Suppose you want to heat a cup of soup for one minute at MICRO HIGH (100%).

PROCEDURE	
<p>1 Touch MINUTE PLUS.</p>	

NOTE:

1. To use MINUTE PLUS for MICRO HIGH (100%) cooking, touch MINUTE PLUS within 3 minutes after touching **STOP/CLEAR** or closing the door. Be sure the display shows the time of day or a colon (:) before touching MINUTE PLUS.
2. If you touch MINUTE PLUS within 3 minutes after cooking and the display shows a zero (.0), the previous cooking program can be extended. The oven WILL NOT microwave for minutes using MICRO HIGH (100%). See Note 2 in EXTEND THE COOKING TIME.

EXTEND THE COOKING TIME

After cooking, you can extend the cooking time with the last setting.

The maximum time that can be extended is 10 minutes.

- Suppose you want to extend the cooking time for 5 minutes after completing the GRILL 1 cooking.

PROCEDURE	DISPLAY
<p>After cooking, End is flashing in the display.</p>	
<p>Open and close the door.</p> <p>1</p> <p>Enter desired extending time by rotating the rotary dial.</p>	
<p>2</p> <p>Touch START.</p>	

NOTE:

1. To use the extend function, rotate the rotary dial within 3 minutes after closing the door.
2. You can extend the cooking time using the MINUTE PLUS, which extends cooking time in multiples of 1 minute. Touch the MINUTE PLUS within 3 minutes after closing the door. After touching MINUTE PLUS, the cooking starts automatically.
3. The extend function cannot be used for Popcorn.

TIMER

- Suppose you want to time a 3-minute long distance phone call.

PROCEDURE	
<p>1 Enter time.</p>	
<p>2 Touch TIMER.</p>	

OTHER CONVENIENT FEATURES

MORE OR LESS TIME ADJUSTMENT

Should you discover that you like any of the Microwave options or Express Defrost settings slightly **more** done, rotate the rotary dial clockwise until desired time bar appears before touching **START**.

Should you discover that you like any of the Microwave options or Express Defrost settings slightly **less** done, rotate the rotary dial **counterclockwise** until desired time bar appears before touching **START**.

The number of the more/less bars shows the doneness:

Original setting = 3 bars

More = 5 bars

Less = 1 bar

CHILD LOCK

The Child Lock prevents unwanted oven operation such as by small children. The oven can be set so that the control panel is deactivated or locked. To set, touch **TIMER/CLOCK**, adjust the rotary dial to and then touch the **START** and hold for three seconds. Should a button be touched, will appear in the display.

To cancel, touch **TIMER/CLOCK**, adjust rotary dial to

and touch **STOP/CLEAR**.

AUDIBLE SIGNAL ELIMINATION

If you wish to have the oven operate with no audible signals, touch **TIMER/CLOCK**, adjust rotary dial to and then touch the **START** and hold for three seconds.

To cancel, touch **TIMER/CLOCK**, adjust rotary dial to and touch **STOP/CLEAR**.

DEMONSTRATION MODE

To demonstrate, touch **TIMER/CLOCK**, adjust rotary dial to and then touch the **START** and hold for 3 seconds.

will appear in the display. Cooking operations and special features can now be demonstrated with no power in the oven. For example, touch **MINUTE PLUS** and the display will show and count down quickly to .

To cancel, touch **TIMER/CLOCK**, adjust rotary dial to and touch **STOP/CLEAR**. If easier, unplug the oven from the electrical outlet and replug.

CLEANING AND CARE

Disconnect the power cord before cleaning or leave the door open to inactivate the oven during cleaning. Ensure the oven is completely cool before cleaning.

Exterior

The outside surface is painted. Clean the outside with mild soap and water; rinse and dry with a soft cloth. Do not use any type of household or abrasive cleaner.

Door

Wipe the window on both sides with a damp cloth to remove any spills or splatters. Metal parts will be easier to maintain if wiped frequently with a damp cloth and polished dry with a soft cloth. Avoid the use of spray and other harsh cleaners as they may stain, streak or dull the door surface.

Control Panel

Wipe the panel with a cloth dampened slightly with water only. Dry with a soft cloth. Do not scrub or use any sort of chemical cleaners. Close door and touch **STOP/CLEAR**.

Interior - after microwave cooking.

Cleaning is easy because little heat is generated to the interior surfaces; therefore, there is no baking and setting of spills or spattering. To clean the interior surfaces, wipe with a soft cloth and warm water. **DO NOT USE ABRASIVE OR HARSH CLEANERS OR SCOURING PADS.** For heavier soil, use baking soda or a mild soap; rinse thoroughly with hot water. **NEVER SPRAY OVEN CLEANERS DIRECTLY ONTO ANY PART OF THE OVEN.**

Interior - after grill, bake or automatic cookings.

Spatters may occur because of moisture and grease. Wash immediately after use with hot, soapy water. Rinse and polish dry. Harder to remove spatters may occur if oven is not thoroughly cleaned or if there is long time/high temperature cooking. If so, you may wish to purchase an oven cleaner pad with liquid cleaner within it--not a soap filled steel pad--for use on stainless or porcelain surfaces. Follow manufacturer's directions carefully and be especially cautious not to get any of the liquid cleaner in the perforations on the wall or ceiling or any door surfaces.

Rinse thoroughly and polish dry. After cleaning the interior thoroughly, residual grease may be removed from the interior ducts and heater by simply operating the oven using both top and bottom heaters for 20 minutes without food. See **CONDITION THE HEATER** on page 11. Ventilate the room if necessary.

Waveguide Cover

The waveguide cover is made from mica so requires special care. Keep the waveguide cover clean to assure good oven performance. Carefully wipe with a damp cloth any food splatters from the surface of the cover immediately after they occur. Built-up splashes may overheat and cause smoke or possibly catch fire. Do not remove the waveguide cover.

Odor Removal

Occasionally, a cooking odor may remain in the oven. To remove, combine 1 cup water, grated peel and juice of 1 lemon and several whole cloves in a 2-cup glass measuring cup. Boil for several minutes using 100% power. Allow to set in oven until cool. Wipe interior with a soft cloth.

Turntable/Turntable Support

The turntable and turntable support can be removed for easy cleaning. Place your fingers tightly over the center of the turntable support and lift to remove it carefully to prevent touching the top heater. If the turntable support fits firmly on to the turntable motor shaft, it may be necessary to twist the turntable support gently to remove it. Wash in mild, sudsy water; for stubborn stains use a mild cleanser and a non-abrasive scouring sponge. They are also dishwasher-proof. Use upper rack of dishwasher. The turntable motor shaft is not sealed, so excess water or spills should be wiped up immediately.

SERVICE CALL CHECK

Please check the following before calling for service:

1. Place one cup of water in a glass measuring cup in the oven and close the door securely. Operate the oven for one minute at MICRO 100%.
 - A** Does the oven light come on? YES _____ NO _____
 - B** Does the cooling fan work?
(Put your hand over the rear ventilating openings.) YES _____ NO _____
 - C** Does the turntable rotate?
(It is normal for the turntable to turn in either direction.) YES _____ NO _____
 - D** Is the water in the oven warm? YES _____ NO _____

2. Remove water from the oven and operate the oven for 5 minutes at BAKE 400°F.
 - A** Do HEATER and COOK indicators light? YES _____ NO _____
 - B** After the oven shuts off, is inside of the oven hot? YES _____ NO _____

If “NO” is the answer to any of the above questions, please check electrical outlet, fuse and/or circuit breaker. If they are functioning properly, CONTACT YOUR NEAREST SHARP AUTHORIZED SERVICER. A microwave oven should never be serviced by a “do-it-yourself” repair person.

- NOTE:**
1. If time appearing in the display is counting down very rapidly, check DEMONSTRATION MODE on page 22 and cancel.
 2. If the oven is set for more than 20 minutes at MICRO 100 percent power level, after the first 20 minutes the power level will automatically adjust to 70 percent power to avoid overcooking.
 3. This oven adjusts GRILL, BAKE and AUTOMATIC COOKING by turning the top and bottom heaters on and off. It is normal to observe the top heater change from red to dark gray.
 4. After cooking is completed, the cooling fan may run for a short time to lower the temperature.

SPECIFICATIONS

AC Line Voltage:	Single phase 120V, 60Hz, AC only
AC Power Required: Microwave Grill/Bake	980 W 8.5A 1300W 10.8 A
Output Power: Microwave Top heater Bottom heater	650 W* (IEC Test Procedure) 760 W 510 W
Frequency:	2450 MHz
Outside Dimensions:	17-3/4"(W) x 11-3/8"(H) x 15-1/8"(D)
Cavity Dimensions**:	11-1/4"(W) x 5-7/8"(H) x 11-5/8"(D)
Oven Capacity**:	Approx. 0.5 Cu. Ft.
Cooking Uniformity:	Turntable system, 10 1/2" diameter
Weight:	Approx. 31lb

- ★ The International Electrotechnical Commission's standardized method for measuring output wattage. This test method is widely recognized.
- ★★ Internal capacity is calculated by measuring maximum width, depth and height. Actual capacity for holding food is less.

In compliance with standards set by:

FCC – Federal Communications Commission Authorized.

DHHS – Complies with Department of Health and Human Services (DHHS) rule, CFR, Title 21, Chapter I, Subchapter J.



– This symbol on the nameplate means the product is listed by Underwriters Laboratories, Inc.

GUIA AUTO-TOUCH

Para mayor información y precauciones de seguridad, consulte el Manual de Operaciones.

FIJACION DEL RELOJ

Si en la pantalla aparece **88:88** toque primero **STOP/CLEAR**.

1 Pulse **CLOCK** e introduzca la hora empleando el mando giratorio.



2 Pulse **CLOCK** e introduzca los minutos empleando el mando giratorio.



3 Touch **CLOCK**.



OPCIONES DE MICROONDAS

1 Toque el botón **POPCORN** una vez para palomitas de maiz regular.
2 veces--tamaño regular ligero
3 veces--tamaño de snack



2 Toque **START**



ALIMENTO	CANTIDAD
Popcorn (Palomitas de maiz)	3.5 onzas. (Normal) 2.85-3.5 onzas. (Normal ligero) 1.5 o 1.75 onzas. (Refrigerio)
Reheat (Recalentamiento)	
Casserole (Caserola)	1-2 tazas
Dinner plate (Plato principal)	1plato: pequeño, normal
Beverage (Bebida)	.5-2.0 tazas
Frozen Entrees (Plato fuerte congelado)	3-6, 7-10 onzas.
Fresh Vegetables (Verduras frescas)	1-2 tazas

EXPRESS DEFROST (DESCONGELACIÓN RÁPIDA)

1 Introduzca el peso deseado pulsando **EXPRESS DEFROST**.
Ej. Pulse **EXPRESS DEFROST** 7 veces para 2.0lb.



2 Toque **START**.



ALIMENTO	CANTIDAD
Ground meat (Carne picada)	.5-2.0 libras
Steaks/Chops (Filetes, chuletas)	.5-2.0 libras
Boneless Poultry (Sin hueso aves)	.5-1.5 libras
Bone-in Poultry (Con hueso aves)	.5-2.0 libras

AUTOMATIC COOKING (COCINADO AUTOMÁTICO)

1. Seleccione la comida deseada pulsando repetidamente **TOAST/SNACKS/BAKE** (**TOSTADA/REFRIGERIOS/COCCIÓN**).
2. Ajuste la intensidad de cocinado, si es necesario, ajustando el mando rotativo. Toque el botón **START**.

AJUSTE	VISUALIZACIÓN	COMIDA	AJUSTES ORIGINALES	
			MENOS TIEMPO/ MENOS HECHO	MÁS TIEMPO/ MÁS HECHO
TOAST (TOSTADA) 	AT- 1(Pulse 1 vez)	Pan	1-4 rodajas	
	AT- 2(Pulse 2 veces)	Rosquillas	2 mitades	
	AT- 3(Pulse 3 veces)	Waffle	2 temperatura ambiental	2 congelado
	AT- 4(Pulse 4 veces)	Tostadas francesas	1-2 rodajas	
	AT- 5(Pulse 5 veces)	Pasteles tostados	1-2 temperatura ambiental	1-2 congelado
SNACKS (REFRIGERIOS) 	AS- 1(Pulse 1 vez)	Patatas fritas	1/2 libra	
	AS- 2(Pulse 2 veces)	Pizza congelada	5-7 onzas	14 onzas
	AS- 3(Pulse 3 veces)	Hamburguesas	3 medio hecho	4 medio hecho 3 bien hecho
	AS- 4(Pulse 4 veces)	Aperitivos congelados	4-8 piezas	
	AS- 5(Pulse 5 veces)	Perros calientes / Salchichas	3-4	
BAKE (COCCIÓN) 	AB- 1(Pulse 1 vez)	Papas asadas	1 medio hecho	
	AB- 2(Pulse 2 veces)	Biscochos	1 medio hecho	
	AB- 3(Pulse 3 veces)	Panecillos	hecho en casa	vendido congelado
	AB- 4(Pulse 4 veces)	Biscochos de chocolate y nueces	recipiente de 6 tazas	
	AB- 5(Pulse 5 veces)	Tartas	recipiente de 8 pulgadas recipiente de 9 o 9 pulgadas	

TIEMPO DE COCINADO POR MICROONDA

Cocinado Micro 100%

1 Introduzca el tiempo de cocinado.



2 Toque **START**.



Cocción de Potencia Variable

1 Después del paso 1 anterior, toque el botón **POWER LEVEL** 4 veces. Ej. 30%



2 Toque **START**.



GRILL (ASADO)

1 Toque **GRILL**.

Una vez G-1 Calentador superior
Dos veces G-2 Calentadores superior e inferior



2 Introduzca el tiempo de cocinado empleando el mando giratorio.



3 Toque **START**.



BAKE (COCCIÓN)

1 Seleccione la temperatura deseada pulsando **BAKE**. Ej . Pulse **BAKE** 3 veces para 350F
Los ajustes de la temperatura son 400, 375, 350, 325F.



2 Introduzca el tiempo de cocinado empleando el mando giratorio.



3 Toque **START**.

Se inicia el precalentamiento.



4 Después del precalentamiento, ponga la comida en el horno y pulse **START**.



MINUTE PLUS (MINUTO EXTRA)

Pulse **MINUTE PLUS** para un minuto a cocinado **MICRO 100%** o para añadir un minuto durante el cocinado manual. Siga pulsándolo para minutos adicionales.



AUTO-TOUCH GUIDE

For more complete information and safety precautions, refer to your Operation Manual.

SET CLOCK

If **88:88** is in display, first touch **STOP/CLEAR** pad.

- 1 Touch **CLOCK** and enter the hour by using the rotary dial.
- 2 Touch **CLOCK** and enter the minutes by using the rotary dial.
- 3 Touch **CLOCK** again.

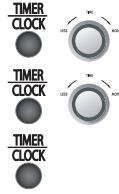

MICROWAVE OPTIONS

- 1 Touch **POPCORN** pad:
Once for regular size
Twice for regular size light
3 times for snack size
- 2 Touch **START**



FOOD	AMOUNT
Popcorn	3.5 oz. (Regular) 2.85-3.5 oz. (Regular Light) 1.5 or 1.75 oz. (Snack)
Reheat	
Casserole	1-2 cups
Dinner plate	1plate: small, regular
Beverage	.5-2.0 cups
Frozen Entrees	3-6, 7-10 oz.
Fresh Vegetables	1-2 cups

EXPRESS DEFROST

- 1 Enter desired weight by touching **EXPRESS DEFROST**.
Ex. Touch **EXPRESS DEFROST** 7 times for 2.0lb.
- 2 Touch **START**.



FOOD	AMOUNT
Ground meat	.5-2.0 lb
Steaks/Chops	.5-2.0 lb
Boneless Poultry	.5-1.5 lb
Bone-in Poultry	.5-2.0 lb

MICROWAVE TIME COOKING

Micro 100% Cooking

- 1 Enter cooking time by using the rotary dial.
- 2 Touch **START**.



Variable Power Cooking

- 1 After Step 1 above, touch **MICRO** pad 4 times. Ex. 30%
- 2 Touch **START**.



GRILL

- 1 Touch **GRILL**.
Once G-1 Top heater
Twice G-2 Top and bottom heaters
- 2 Enter cooking time by using the rotary dial.



- 3 Touch **START**.

BAKE

- 1 Select desired temperature by touching **BAKE**. Ex. Touch **BAKE** 3 times for 350F
Temperature settings are 400, 375, 350, 325F.
- 2 Enter cooking time by using the rotary dial.
- 3 Touch **START**. Preheat starts.
- 4 After preheat, place food in the oven and touch **START**.



MINUTE PLUS

Touch **MINUTE PLUS** pad for one minute at MICRO 100 % cooking or to add a minute during manual cooking. Continue to touch for additional minutes.



AUTOMATIC COOKING

1. Select the desired food by touching **TOAST/SNACKS/BAKE** repeatedly.
2. Adjust cooking doneness, if necessary, by turning rotary dial. Touch **START**.

SETTING	DISPLAY	FOOD	LESS TIME/LIGHTER				MORE TIME/DARKER			
			Turn left to 1 bar	Turn left to 2 bars	Turn right to 4 bars	Turn right to 5 bars				
TOAST Use turntable support only. TOAST	AT- 1(Press 1 time)	Bread			1-4 slices					
	AT- 2(Press 2 times)	Bagels	1 half		2 halves					
	AT- 3(Press 3 times)	Waffles	1 room temp or frozen		2 room temp		2 frozen			
	AT- 4(Press 4 times)	French Toast	3-6 sticks		1-2 slices					
	AT- 5(Press 5 times)	Toaster Pastries			1-2 room temp		1-2 frozen			
SNACKS SNACKS	AS- 1(Press 1 time)	French Fries			1/2 pound					
	AS- 2(Press 2 times)	Frozen Pizza			5-7 oz		14 oz			
	AS- 3(Press 3 times)	Hamburgers	1 medium	2 medium 1 well done	3 medium	4 medium 3 well done	4 well done			
	AS- 4(Press 4 times)	Frozen Appetizers			4-8 pieces					
	AS- 5(Press 5 times)	Hot Dogs/Sausage	1-2		3-4					
BAKE BAKE	AB- 1(Press 1 time)	Baked Potatoes	1 medium		2 medium					
	AB- 2(Press 2 times)	Biscuits		convenience refrigerated	home made	convenience frozen				
	AB- 3(Press 3 times)	Muffins			6-cup pan					
	AB- 4(Press 4 times)	Brownies			8-inch pan					
	AB- 5(Press 5 times)	Cakes	6 cupcakes		8 or 9-inch pan					

SHARP

SHARP ELECTRONICS CORPORATION
Sharp Plaza, Mahwah, NJ 07430-2135

TINSEA983WRRZ-D32
Printed in China