

SHARP®

HIGH SPEED CONVECTION MICROWAVE OVEN OPERATION MANUAL

Carousel®

MODEL

R-90GC

CONTENTS

- 
- Precautions to Avoid Possible Exposure to Excessive Microwave Energy Inside Front Cover
 - For Customer Assistance ... Inside Front Cover
 - Consumer Limited Warranty 1
 - Product Information Card 1
 - Important Safety Instructions 2
 - Unpacking and Installation Instructions... 3
 - Grounding Instructions 4
 - Information You Need to Know 5-8
 - Part Names 9-10
 - Before Operating 11
 - Manual Cooking 11-14
 - Automatic Cooking 15-27
 - Speed Cooking 15-22
 - Microwave Options 23-27
 - Other Convenient Features 28-30
 - Cleaning and Care 31
 - Service Call Check 32
 - Specifications 32

READ ALL INSTRUCTIONS CAREFULLY BEFORE USING THE OVEN.

FOR CUSTOMER ASSISTANCE

To aid in reporting this High Speed Convection Microwave Oven in case of loss or theft, please record below the model number and serial number located on the unit. We also suggest you record all the information listed and retain for future reference.

Please provide the following information when you write or call: model number, serial number, date of purchase, your complete mailing address (including zip code), your daytime telephone number (including area code) and description of the problem.

MODEL NUMBER _____	SERIAL NUMBER _____
DATE OF PURCHASE _____	
DEALER _____	TELEPHONE _____
SERVICER _____	TELEPHONE _____

TO PHONE:

DIAL 1-800- BE-SHARP (237-4277) for :

SERVICE (for your nearest Sharp Authorized Servicer)

PARTS (for your authorized parts distributor)

ADDITIONAL CUSTOMER INFORMATION

DIAL 1-800-642-2122 for :

ACCESSORIES and SHARP CAROUSEL COOKBOOK(microwave only recipes)

TO WRITE:

Sharp Electronics Corporation

Customer Assistance Center

1300 Naperville Drive

Romeoville, IL 60446-1091

TO ACCESS INTERNET: www.sharp-usa.com

PRECAUTIONS TO AVOID POSSIBLE EXPOSURE TO EXCESSIVE MICROWAVE ENERGY

- (a) Do not attempt to operate this oven with the door open since open-door operation can result in harmful exposure to microwave energy. It is important not to defeat or tamper with the safety interlocks.
- (b) Do not place any object between the oven front face and the door or allow soil or cleaner residue to accumulate on sealing surfaces.
- (c) Do not operate the oven if it is damaged. It is particularly important that the oven door close properly and that there is no damage to the: (1) door (bent), (2) hinges and latches (broken or loosened), (3) door seals and sealing surfaces.
- (d) The oven should not be adjusted or repaired by anyone except properly qualified service personnel.

CONSUMER LIMITED WARRANTY

SHARP ELECTRONICS CORPORATION warrants to the first consumer purchaser that this Sharp brand product (the "Product"), when shipped in its original container, will be free from defective workmanship and materials, and agrees that it will, at its option, either repair the defect or replace the defective Product or part thereof with a new or remanufactured equivalent at no charge to the purchaser for parts or labor for the period(s) set forth below.

This warranty does not apply to any appearance items of the Product nor to the additional excluded item(s) set forth below nor to any Product the exterior of which has been damaged or defaced, which has been subjected to improper voltage or other misuse, abnormal service or handling, or which has been altered or modified in design or construction.

In order to enforce the rights under this limited warranty, the purchaser should follow the steps set forth below and provide proof of purchase to the servicer.

The limited warranty described herein is in addition to whatever implied warranties may be granted to purchasers by law. ALL IMPLIED WARRANTIES INCLUDING THE WARRANTIES OF MERCHANTABILITY AND FITNESS FOR USE ARE LIMITED TO THE PERIOD(S) FROM THE DATE OF PURCHASE SET FORTH BELOW. Some states do not allow limitations on how long an implied warranty lasts, so the above limitation may not apply to you.

Neither the sales personnel of the seller nor any other person is authorized to make any warranties other than those described herein, or to extend the duration of any warranties beyond the time period described herein on behalf of Sharp.

The warranties described herein shall be the sole and exclusive warranties granted by Sharp and shall be the sole and exclusive remedy available to the purchaser. Correction of defects, in the manner and for the period of time described herein, shall constitute complete fulfillment of all liabilities and responsibilities of Sharp to the purchaser with respect to the Product, and shall constitute full satisfaction of all claims, whether based on contract, negligence, strict liability or otherwise. In no event shall Sharp be liable, or in any way responsible, for any damages or defects in the Product which were caused by repairs or attempted repairs performed by anyone other than an authorized servicer. Nor shall Sharp be liable or in any way responsible for any incidental or consequential economic or property damage. Some states do not allow the exclusion of incidental or consequential damages, so the above exclusion may not apply to you.

THIS WARRANTY GIVES YOU SPECIFIC LEGAL RIGHTS. YOU MAY ALSO HAVE OTHER RIGHTS WHICH VARY FROM STATE TO STATE.

Your Product Model Number & Description:

R-90GC Home Use High Speed Convection Microwave Oven. (Be sure to have this information available when you need service for your Product.)

Warranty Period for this Product:

One (1) year parts and labor in-home service. The warranty period continues for an additional six (6) years, for a total of seven (7) years, with respect to the magnetron tube in the Product. Labor and the servicer trip charge are provided free of charge for this additional period.

Additional Item(s) Excluded from Warranty Coverage (if any):

Non-functional accessories, turntable, splash guard, high rack, low rack and light bulb.

Where to Obtain Service:

From a Sharp Authorized Servicer located In the United States. For in-home service, the servicer will come to the unit's location. If it is necessary to remove the unit for repair, the servicer will reinstall the unit at no extra charge, provided it was installed according to Sharp's Installation Instructions. To find the location of the nearest Sharp Authorized Servicer, call Sharp toll free at 1-800-BE-SHARP (1-800-237-4277).

What to do to Obtain Service:

Ship prepaid or carry in your Product to a Sharp Authorized Servicer. Be sure to have **Proof of Purchase** available. If you ship the Product, be sure it is insured and packaged securely.

TO OBTAIN SUPPLY, ACCESSORY OR PRODUCT INFORMATION, CALL
1-800-BE-SHARP OR VISIT www.Sharpusa.com.

Save the proof of purchase as it is needed should your oven ever require warranty service.

PRODUCT INFORMATION CARD

The product information card, which is on the inside of the high speed oven carton, should be completed within ten days of purchase and returned. We will keep it on file and help you access the information in case of loss, damage or theft. This will also enable us to contact you in the unlikely event that any adjustments or modifications are ever required for your oven.

IMPORTANT SAFETY INSTRUCTIONS

When using electrical appliances basic safety precautions should be followed, including the following:

WARNING - To reduce the risk of burns, electric shock, fire, injury to persons or exposure to excessive microwave energy:

1. **Read all instructions before using the appliance.**
2. Read and follow the specific **“PRECAUTIONS TO AVOID POSSIBLE EXPOSURE TO EXCESSIVE MICROWAVE ENERGY”** on inside front cover.
3. This appliance must be grounded. Connect only to properly grounded outlet. See **“GROUNDING INSTRUCTIONS”** on page 4.
4. Install or locate this appliance only in accordance with the provided installation instructions.
5. Some products such as whole eggs and sealed containers—for example, closed glass jars—are able to explode and should not be heated in this oven.
6. Use this appliance only for its intended use as described in this manual. Do not use corrosive chemicals or vapors in this appliance. This type of oven is specifically designed to heat, cook or dry food. It is not designed for industrial or laboratory use.
7. As with any appliance, close supervision is necessary when used by children.
8. Do not operate this appliance if it has a damaged cord or plug, if it is not working properly or if it has been damaged or dropped.
9. This appliance should be serviced only by qualified service personnel. Contact nearest Sharp Authorized Servicer for examination, repair or adjustment.
10. Do not cover or block any openings on the appliance.
11. Do not store or use this appliance outdoors. Do not use this product near water—for example, near a kitchen sink, in a wet basement, near a swimming pool or similar locations.
12. Do not immerse cord or plug in water.
13. Keep cord away from heated surfaces.
14. Do not let cord hang over edge of table or counter.
15. See door surface cleaning instructions on page 31.
16. To reduce the risk of fire in the oven cavity:
 - a. Do not overcook food. Carefully attend appliance when paper, plastic or other combustible materials are placed inside the oven to facilitate cooking.
 - b. Remove wire twist-ties from paper or plastic bags before placing bag in oven.
 - c. **If materials inside the oven ignite, keep oven door closed, turn oven off and disconnect the power cord or shut off power at the fuse or circuit breaker panel.**
 - d. Do not use the cavity for storage purposes. Do not leave paper products, cooking utensils or food in the cavity when not in use.
17. Liquids, such as water, coffee or tea are able to be overheated beyond the boiling point without appearing to be boiling. Visible bubbling or boiling when the container is removed from the microwave oven is not always present. **THIS COULD RESULT IN VERY HOT LIQUID SUDDENLY BOILING OVER WHEN A SPOON OR OTHER UTENSIL IS INSERTED INTO THE LIQUID.** To reduce the risk of injury to persons:
 - a. Do not overheat the liquid.
 - b. Stir the liquid both before and halfway through heating it.
 - c. Do not use straight-sided containers with narrow necks. Use a wide-mouthed container.
 - d. After heating, allow the container to stand in the microwave oven at least for 20 seconds before removing the container.
 - e. Use extreme care when inserting a spoon or other utensil into the container.
18. If the oven light fails, consult a SHARP AUTHORIZED SERVICER.
19. Do not operate any heating or cooking appliance beneath this appliance, except a properly installed electric wall oven listed on page 3.
20. Do not mount unit over or near any portion of a heating or cooking appliance, except a properly installed electric wall oven listed on page 3.
21. Do not mount over a sink.
22. Do not store anything directly on top of the appliance surface when the appliance is in operation.

SAVE THESE INSTRUCTIONS

UNPACKING AND INSTALLATION INSTRUCTIONS

Unpacking and Examining Your Oven

Remove:

1. all packing materials from inside the oven cavity; however, **DO NOT REMOVE THE WAVEGUIDE COVER**, which is located on the right cavity wall. Read enclosures and **SAVE** the Operation Manual, Sharp High Speed Convection Microwave Oven Cookbook and Touch Guide.

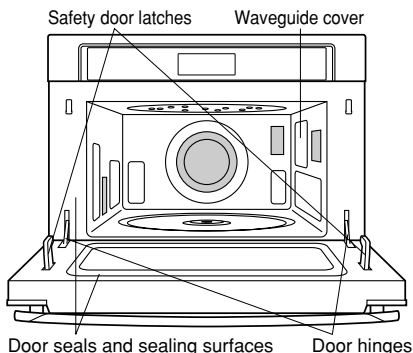

2. the feature sticker, if there is one, from the outside of the door.

Check the oven for any damage, such as misaligned or bent door, damaged door seals and sealing surfaces, broken or loose door hinges and latches and dents inside the cavity or on the door. If there is any damage, do not operate the oven and contact your dealer or SHARP AUTHORIZED SERVICER.

Choosing a Location for Your Oven

You will use your oven frequently so plan its location for ease of use. The oven must be placed on a countertop which is a minimum of 36 inches from the floor. Allow at least 2 inches on the sides, top and at the rear of the oven for air circulation. Be sure to position oven so that the rear cannot be touched inadvertently.

Your oven can be built into a cabinet or wall by itself or above a specific electric wall oven using Sharp's Built-in Kit listed below. It cannot be built in above conventional gas or electric ranges or any other wall ovens.

Sharp's Built-in kits	Applicable Electric Wall Ovens	
RK-90S30	G.E.	JTP18S0D1SS
	DCS	DCS-WO-130SS
	VIKING	VESO105SS
RK-90S27	DCS	DCS-WO-127SS
	VIKING	VESO176SS

Note for Sharp's Built-in kits:

Select the Built-in kit RK-90S27 or RK-90S30 depending on the desired finished width. The RK-90S27 is for a 27 inch and the RK-90S30 is for a 30 inch finished width.

See Sketch 1 for proper location when building in above the specified wall ovens. Carefully follow both the wall oven installation instructions and Sharp's Built-in Kit instructions. Be sure that the clearance of the floor between the wall oven and the high speed oven is minimum of 2 inches.

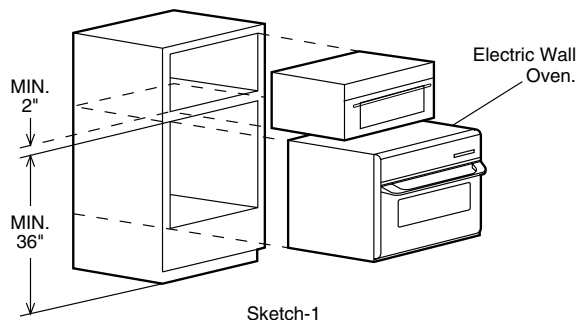

Ordering the Built-in Kit.

If your dealer does not stock the kit, it can be ordered directly from the Sharp Accessories and Supplies Center. Have your credit card number available and call toll-free: 1-800-642-2122 for ordering the kit to be sent to your address. The kit includes ducts and finish trim strips and easy-to-follow instructions for installation as well as the location of the power supply.

GROUNDING INSTRUCTIONS

This appliance must be grounded. This oven is equipped with a cord having a grounding wire with a grounding plug. It must be plugged into a wall receptacle that is properly installed and grounded in accordance with the National Electrical Code and local codes and ordinances. In the event of an electrical short circuit, grounding reduces risk of electric shock by providing an escape wire for the electric current.

WARNING – Improper use of the grounding plug can result in a risk of electric shock.

Electrical Requirements

The electrical requirements are a 240 volt 60 Hz, AC only, 15 amp. protected electrical supply. It is recommended that a separate circuit serving only this appliance be provided. The 240 volt circuit is absolutely necessary for optimum cooking performance.

The oven is equipped with a 3-prong grounding plug. It must be plugged into a wall receptacle that is properly installed and grounded.

Permanent and Correct Installation

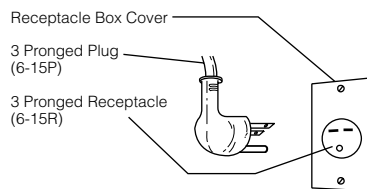

Extension Cord

If it is necessary to use an extension cord, use only a 3-wire extension cord that has a 3-blade grounding plug and a 3-slot receptacle that will accept the plug on the high speed oven. The marked rating of the extension cord should be AC 240 volt, 15 amp. or more.

Be careful not to drape the cord over the countertop or table where it can be pulled on by children or tripped over accidentally.

- Notes:**
1. If you have any questions about the grounding or electrical instructions, consult a qualified electrician or service person.
 2. Neither Sharp nor the dealer can accept any liability for damage to the oven or personal injury resulting from failure to observe the correct electrical connection procedures.

Radio or TV Interference

Should there be any interference caused by the high speed oven to your radio or TV, check that the high speed oven is on a different electrical circuit, relocate the radio or TV as far away from the oven as feasible or check position and signal of receiving antenna.

INFORMATION YOU NEED TO KNOW

ABOUT YOUR OVEN

This Operation Manual is valuable: read it carefully and always save it for reference.

The Sharp High Speed Convection Microwave Cookbook is a valuable asset. Check it frequently for cooking principles, techniques, hints and recipes.

NEVER use the oven without the turntable and support nor turn the turntable over so that a large dish could be placed in the oven. The turntable will turn both clockwise and counterclockwise.

ALWAYS have food in the oven when it is on to absorb the microwave energy.

When using the oven at power levels below 100%, you may hear the magnetron cycling on and off. It is normal for the exterior of the oven to be warm to the touch when cooking or reheating.

Condensation is a normal part of microwave cooking. Room humidity and the moisture in food will influence

the amount of moisture that condenses in the oven. Generally, covered foods will not cause as much condensation as uncovered ones. Vents on the oven back must not be blocked.

After using, the cooling fan may come on to cool the oven cavity. The display will show NOW COOLING, and you will hear the sound of the fan.

Unlike microwave-only ovens, your oven may become hot during cooking. Be cautious.

The oven is for food preparation only. It should not be used to dry clothes or newspapers.

The microwave capability of your oven is rated 1000 watts by using the IEC Test Procedure. In using microwave-only recipes or package directions, check food a minute or two before the minimum time and add time accordingly.

ABOUT FOOD

FOOD	DO	DON'T
Eggs, sausages, nuts, seeds fruits & vegetables	<ul style="list-style-type: none"> Puncture egg yolks before cooking to prevent "explosion". Pierce skins of potatoes, apples, squash, hot dogs and sausages so that steam escapes. 	<ul style="list-style-type: none"> Cook eggs in shells. Reheat whole eggs. Dry nuts or seeds in shells.
Popcorn	<ul style="list-style-type: none"> Use specially bagged popcorn for the microwave oven. Listen while popping corn for the popping to slow to 1 or 2 seconds or use special POPCORN pad. Use an overturned 9 or 10 inch oven proof glass pie plate on top of the turntable when popping bagged microwave popcorn. 	<ul style="list-style-type: none"> Pop popcorn in regular brown bags or glass bowls. Exceed maximum time on popcorn package.
Baby food	<ul style="list-style-type: none"> Transfer baby food to small dish and heat carefully, stirring often. Check temperature before serving. Put nipples on bottles after heating and shake thoroughly. "Wrist" test before feeding. 	<ul style="list-style-type: none"> Heat baby food in original jars. Heat disposable bottles. Heat bottles with nipples on.
General	<ul style="list-style-type: none"> Cut baked goods with filling after heating to release steam and avoid burns. Stir liquids briskly before heating and allow to stand at least for 20 seconds after heating before stirring or drinking to avoid eruption. Use deep bowl, when cooking liquids or cereals, to prevent boilovers. 	<ul style="list-style-type: none"> Heat or cook in closed glass jars or air tight containers. Can in the microwave as harmful bacteria may not be destroyed. Deep fat fry. Dry wood, gourds, herbs or wet papers.

INFORMATION YOU NEED TO KNOW

ABOUT UTENSILS AND COVERINGS

It is not necessary to buy all new cookware. Many pieces already in your kitchen can be used successfully in your new High Speed Convection Microwave Oven. The chart below will help you decide what utensils and coverings should be used in each mode.

Utensils and Coverings	Microwave Only	Convection, Grill and Bake	Roast
Aluminum foil	Yes Small flat pieces of aluminum foil placed smoothly on food can be used to shield areas from cooking or defrosting too quickly. Keep foil at least 1 inch from walls of oven.	Yes For shielding	Yes For shielding
Aluminum containers	No	Yes Grill/Bake-No cover	No
Browning dish	Yes Do not exceed recommended preheating time. Follow manufacturer's directions.	No	No
Glass ceramic (Pyroceram.®)	Yes Excellent	Yes Excellent	Yes Excellent
Glass, heat-resistant	Yes Excellent. Overturned pie plate necessary for popping popcorn.	Yes Excellent	Yes Excellent
Glass, non-heat-resistant	No	No	No
Lids, glass	Yes	Yes Grill/Bake-No cover	Yes
Lids, metal	No	Yes Grill/Bake-No cover	No
Metal cookware	No	Yes	Yes Do not use metal covering.
Metal, misc: dishes with metallic trim, screws, bands, handles. Metal twist ties	No	No	No
Oven cooking bags	Yes Good for large meats or foods that need tenderizing. DO NOT use metal twist ties.	Yes Grill/Bake-No	Yes DO NOT use metal twist ties.
Paper plates	Yes For reheating	No	No
Paper towels	Yes To cover for reheating and cooking. Do not use recycled paper towels which may contain metal filings.	No	No
Paper, ovenable	Yes	Yes For temperatures up to 400°F. Do not use for Grill.	Yes For temperatures up to 400°F.
Microwave-safe plastic containers	Yes Use for reheating and defrosting. Some microwave-safe plastics are not suitable for cooking foods with high fat and sugar content. Follow manufacturer's directions.	No	No
Plastic, Thermoset®	Yes	Yes Are heat resistant up to 425°F. Do not use for Grill.	Yes
Plastic wrap	Yes Use brands specially marked for microwave use. DO NOT allow plastic wrap to touch food. Vent so steam can escape.	No	No
Pottery, porcelain stoneware	Yes Check manufacturer's recommendation for being microwave safe.	Yes	Yes Must be microwave safe AND ovenable.
Styrofoam	Yes For reheating	No	No
Wax paper	Yes Good covering for cooking and reheating	No	No
Wicker, wood, straw	Yes May be used for short periods of time. Do not use with high fat or high sugar content foods. Could char.	No	No

INFORMATION YOU NEED TO KNOW

DISH CHECK. If you wish to check if a dish is safe for microwaving, place the empty dish in the oven and microwave on HIGH for 30 seconds. If the dish becomes very hot, do NOT use it for microwaving.

AUTOMATIC COOKING Use the recommended container in the cooking chart in this operation manual, cookbook and display.

ACCESSORIES There are many microwave accessories available for purchase. Evaluate carefully before you purchase so that they meet your needs. A microwave-safe thermometer will assist you in determining correct doneness and assure you that foods have been cooked to safe temperatures when using microwave-only cooking. Sharp is not responsible for any damage to the oven when accessories are used.

CAUTION When using ROAST or during automatic cooking, some metal baking utensils may cause arcing when they come in contact with the turntable, oven walls or accessory racks. Arcing is a discharge of electricity that occurs when microwaves come in contact with metal.

If arcing occurs, place a heat resistant dish, such as a Pyrex pie plate or oven-glass plate, between the pan and the turntable or rack. If arcing continues to occur, discontinue using that pan.

ABOUT CHILDREN

Children below the age of 7 should use the high speed oven with a supervising person very near to them. Between the ages of 7 and 12, the supervising person should be in the same room.

The child must be able to reach the oven comfortably; if not, he/she should stand on a sturdy stool.

At no time should anyone be allowed to lean or swing on the oven door.

Children should be taught all safety precautions: use potholders, remove coverings carefully, pay special attention to packages that crisp food because they may be extra hot.

Don't assume that because a child has mastered one cooking skill he/she can cook everything.

Children need to learn that the high speed oven is not a toy. See page 29 for Child Lock feature.

ABOUT MICROWAVE COOKING

- Arrange food carefully. Place thickest areas towards outside of dish.
- Watch cooking time. Cook for the shortest amount of time indicated and add more as needed. Food severely overcooked can smoke or ignite.
- Cover foods while cooking. Check recipe or cookbook for suggestions: paper towels, wax paper, microwave plastic wrap or a lid. Covers prevent spattering and help foods to cook evenly.
- Shield with small flat pieces of aluminum foil any thin areas of meat or poultry to prevent overcooking before dense, thick areas are cooked thoroughly.
- Stir foods from outside to center of dish once or twice during cooking, if possible.
- Turn foods over once during microwaving to speed cooking of such foods as chicken and hamburgers. Large items like roasts must be turned over at least once.
- Rearrange foods such as meatballs halfway through cooking both from top to bottom and from the center of the dish to the outside.
- Add standing time. Remove food from oven and stir, if possible. Cover for standing time which allows the food to finish cooking without overcooking.
- Check for doneness. Look for signs indicating that cooking temperatures have been reached.

Doneness signs include:

- Food steams throughout, not just at edge.
- Center bottom of dish is very hot to the touch.
- Poultry thigh joints move easily.
- Meat and poultry show no pinkness.
- Fish is opaque and flakes easily with a fork.

ABOUT SPEED COOKING AND CONVECTION COOKING

- The oven cabinet, cavity, door, accessories and dishes will become hot. To PREVENT BURNS, use thick oven gloves when removing the food or turntable from the oven.
- When preheating, the turntable can be left in or removed. When using the high rack for 2 shelf baking in a preheated oven, it is easier to remove the turntable for preheat. Place high rack on turntable along with foods. When preheat is over, open oven door and quickly place turntable, high rack and foods to be baked inside.
- Do not cover turntable, low rack or high rack with aluminum foil. It interferes with air flow that cooks food.
- Round pizza pans are excellent cooking utensils for many items. Choose pans that do not have extended handles.
- Using a preheated low rack can give a grilled appearance to steaks and hot dogs.

ABOUT SAFETY

- Check foods to see that they are cooked to the United States Department of Agriculture's recommended temperatures.
- ALWAYS use potholders to prevent burns when handling utensils that are in contact with hot food. Enough heat from the food can transfer through utensils to cause skin burns.
- Avoid steam burns by directing steam away from the face and hands. Slowly lift the farthest edge of a dish's covering and carefully open popcorn and oven cooking bags away from the face.
- Stay near the oven while it's in use and check cooking progress frequently so that there is no chance of overcooking food.
- NEVER use the cavity for storing cookbooks or other items.
- Select, store and handle food carefully to preserve its high quality and minimize the spread of foodborne bacteria.
- Keep waveguide cover clean. Food residue can cause arcing and/or fires.
- Use care when removing items from the oven so that the utensil, your clothes or accessories do not touch the safety door latches.
- Keep aluminum foil used for shielding at least 1 inch away from walls, ceiling and door.

TEMP	FOOD
160°F	... for fresh pork, ground meat, boneless white poultry, fish, seafood, egg dishes and frozen prepared food.
165°F	... for leftover, ready-to-reheat refrigerated, and deli and carry-out "fresh" food.
170°F	... white meat of poultry.
180°F	... dark meat of poultry.

To test for doneness, insert a meat thermometer in a thick or dense area away from fat or bone. NEVER leave the thermometer in the food during cooking, unless using a microwave thermometer when cooking with only microwave power.

PART NAMES

OVEN PARTS

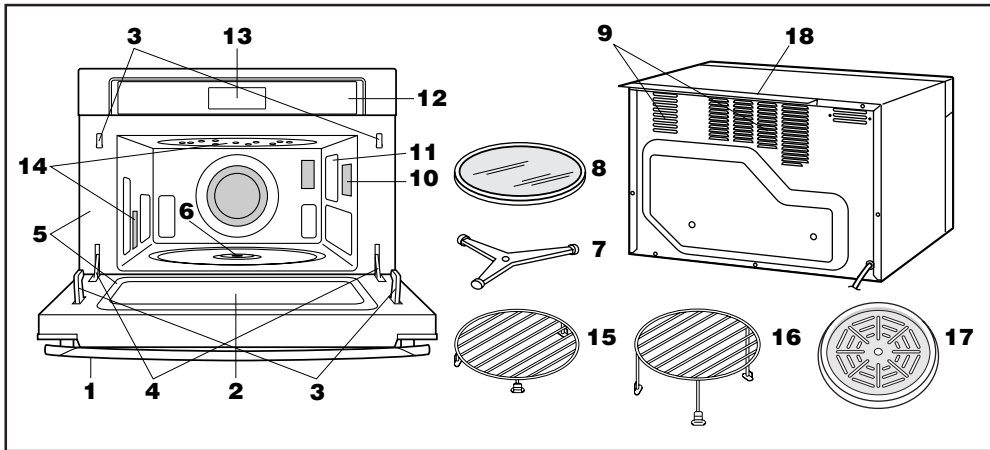

1 Door handle

To open the door, pull the handle down and forward. Never hold the door handle when moving the oven.

2 Oven door with see-through window

3 Safety door latches

The oven will not operate unless the door is securely closed.

4 Door hinges

5 Door seals and sealing surfaces

6 Turntable motor shaft

7 Removable turntable support

Carefully place the turntable support in the center of the oven floor.

After cooking, always clean the turntable support, especially around the rollers. These must be free from food splashes and grease. Built-up splashes or grease may overheat and cause arcing, begin to smoke or catch fire.

8 Removable turntable

Place the turntable on the turntable support securely. The turntable will rotate clockwise or counterclockwise. Only remove for cleaning.

9 Ventilation openings

10 Oven light

It will light when oven is operating or door is open.

11 Waveguide cover: DO NOT REMOVE.

12 Auto-Touch control panel

13 Time display: 99 minutes, 99 seconds

14 Convection air openings

15 Removable low rack

16 Removable high rack

17 Splash guard

18 Ventilation cover: DO NOT REMOVE.

INTERACTIVE DISPLAY

The Interactive Display spells out operating steps and shows cooking hints. When indicator above CUSTOM HELP is lighted, touch CUSTOM HELP to read a specific hint which may assist you.

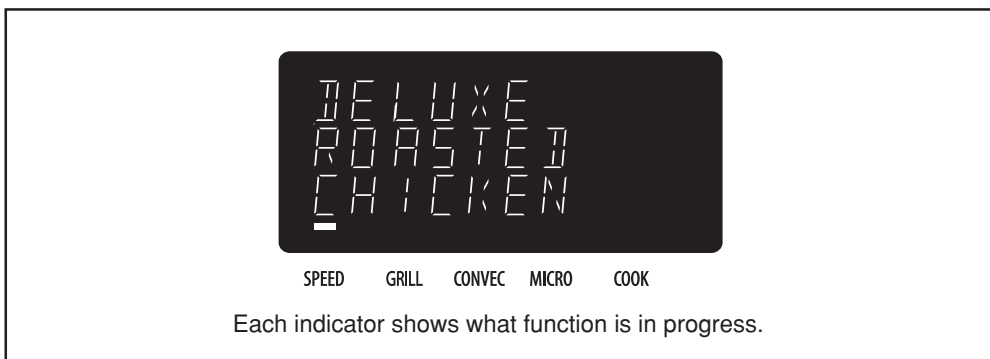

CONTROL PANEL

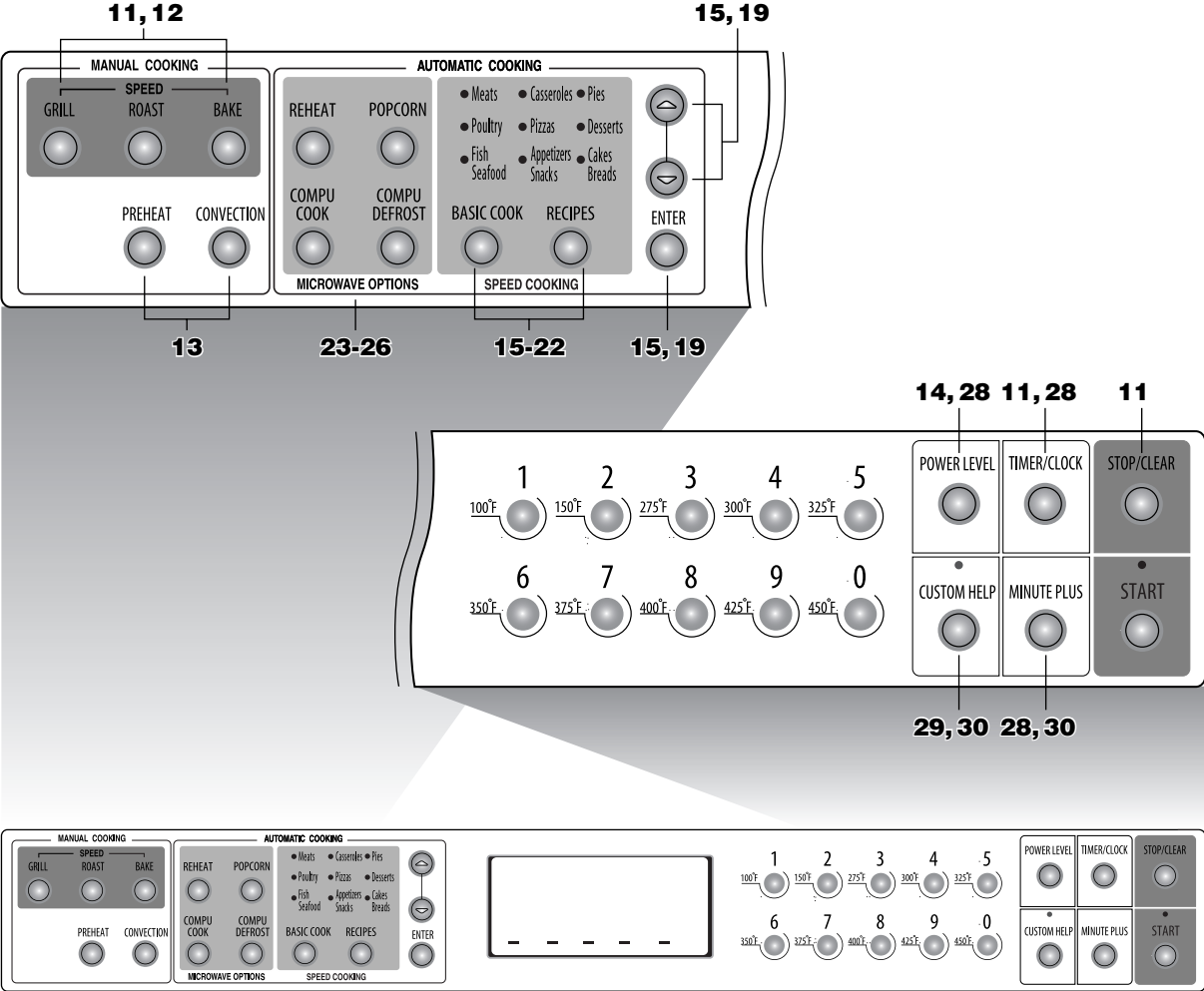



Number next to the control panel illustration indicates page on which there are a feature description and usage information.

BEFORE OPERATING

- Before operating your new oven make sure you read and understand this operation manual completely.
- Before the oven can be used, follow these procedures:
 1. Plug in the oven. Close the door. The oven display will show **SHARP SIMPLY THE BEST PRESS CLEAR AND PRESS CLOCK**.
 2. Touch the **STOP/CLEAR** pad.
 will appear.
 3. Set clock. See below.
 4. Follow directions on page 30 for using the Refresh Cycle.

TO SET THE CLOCK

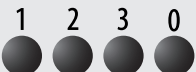
- Suppose you want to enter the correct time of day 12:30.

PROCEDURE	
1 Touch CLOCK and number pad 2 .	
2 Enter the correct time of day by touching the numbers in sequence.	
3 Touch CLOCK again.	

This is a 12 hour clock. If you attempt to enter an incorrect clock time, **ERROR** will appear in the display. Touch the **STOP/CLEAR** pad and re-set the clock.

- If the electrical power supply to your oven should be interrupted, the display will intermittently show **SHARP SIMPLY THE BEST PRESS CLEAR AND PRESS CLOCK** after the power is reinstated. If this occurs during cooking, the program will be erased. The time of day will also be erased. Simply touch **STOP/CLEAR** and reset the clock for the correct time of day.

STOP/CLEAR

Touch the **STOP/CLEAR** to:

1. Erase if you make a mistake during programming.
2. Cancel timer.
3. Stop the oven temporarily during cooking.
4. Return the time of day to the display.
5. Cancel a program during cooking, touch twice.

MANUAL COOKING

SPEED COOKING

Your oven has 3 special speed cooking modes.



Caution:

The oven cabinet, cavity, door, turntable, turntable support, rack and dishes will become hot. To **PREVENT BURNS**, use thick oven gloves when removing the food or turntable.

1. GRILL

Use the **GRILL** setting for steaks, chops, chicken pieces and many other foods you would normally grill that are not included in Basic Cook on pages 16-18. **GRILL** is a preprogrammed setting that cooks fast with a high temperature and maximum speed hot air circulation. Only actual cooking time is entered; the oven signals when it is preheated to 450°F. The oven temperature cannot be changed.

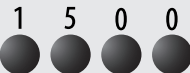
- Suppose you want to grill a steak for 15 minutes.

PROCEDURE	
1 Touch GRILL .	
2 Enter cooking time.	
3 Touch START . Preheat starts. No food in oven.	
When the oven reaches the programmed temperature, a signal will sound 4 times*.	
4 Open the door. Place food in the oven. Close the door. Touch START .	

* If the oven door is not opened, the oven will automatically hold at the preheat temperature for 30 minutes. After this time has elapsed, an audible signal will sound and the oven will turn off.



NOTE:

1. You can grill foods without preheat. To program grill without preheat, touch **GRILL** twice at step 1.
2. Foods cook quickly using **GRILL**. Check often to ensure desired results.
3. Either the high or low rack may be used. The high rack grills food the fastest. Place the splash guard on the turntable with either of the racks over it.

2. ROAST

Use the ROAST setting for poultry, meat, fish or other foods you would normally roast that are not included in Basic Cook on pages 16-18. ROAST is a preprogrammed setting that roasts with high speed air circulation, 325°F. and a boost of microwave power. The cooking time is reduced 33% to 50% compared with typical ovens. No preheat is necessary. Use the low rack over the splash guard so all sides are cooked with a minimum of moisture loss. No pan put on low rack.

- Suppose you want to roast a 3 pound beef rib roast for 20 minutes.

PROCEDURE	
1 Touch ROAST .	
2 Enter cooking time.	
3 Touch START .	

NOTE:

1. The temperature can be changed, however the microwave power cannot.

To change the temperature, touch **ROAST** twice at step 1. When the display shows **SELECT COOKING TEMP**, touch desired temperature pad.

2. When you roast a food for the first time, enter 1/2 the usual roasting time and check doneness carefully during the cooking. If extra time is needed, add and continue to check often until the desired doneness has been achieved.
3. When using ROAST, some metal baking utensils may cause arcing when they come in contact with the turntable, oven walls or accessory racks. Arcing is a discharge of electricity that occurs when microwaves come in contact with metal.



If arcing occurs, place a heat resistant dish, such as a Pyrex pie plate or oven-glass plate, between the pan and the turntable or rack. If arcing continues to occur, discontinue use for roast cooking.

3. BAKE

Use the BAKE setting for cakes, breads and many other foods you would normally bake that take longer than 20 minutes in a conventional oven and are not included in Basic Cook on pages 16-18. BAKE is a preprogrammed setting that makes it easy to bake with high speed air circulation at 325°F.

The baking time is 25% to 33% less than in a conventional oven. No preheat is necessary. Use the low rack.

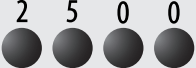
- Suppose you want to bake a cake for 25 minutes.

PROCEDURE	
1 Touch BAKE .	
2 Enter cooking time.	
3 Touch START .	

NOTE:

1. The temperature can be changed. To change the temperature, touch **BAKE** twice at step 1. When the display shows **SELECT COOKING TEMP**, touch desired temperature pad. When adapting recipes or package directions, reduce the suggested baking temperature by 25 F.
2. When you bake for the first time, enter 2/3s of the usual baking time and check carefully throughout the baking. If extra time is needed, add and continue to check often until the desired doneness has been achieved.

MANUAL COOKING





CONVECTION COOKING

The CONVECTION setting is used when conventional time and temperature are desired.

During convection cooking, hot air is circulated throughout the oven cavity to brown and crisp foods evenly. This oven can be programmed for ten different temperatures for up to 99 minutes, 99 seconds.

To Cook with Convection





- Suppose you want to cook at 350°F for 20 minutes:

PROCEDURE	
1 Touch CONVECTION .	
2 Touch temperature pad.	
3 Enter cooking time.	
4 Touch START .	

To Preheat and Cook with Convection

Your oven can be programmed to combine preheating and convection cooking. You can preheat to the same temperature as the convection temperature or change to a higher or lower temperature.

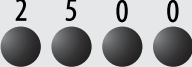
- Suppose you want to preheat and then cook 25 minutes at 350° F:

PROCEDURE	
1 Touch PREHEAT .	
2 Select preheat temperature.	
3 Enter cooking time.	
4 Touch START . Preheat starts. No food in oven.	
When the oven reaches the programmed temperature, a signal will sound 4 times.*	
5 Open the door. Place food in the oven. Close the door. Touch START .	

* If the oven door is not opened, the oven will automatically hold at the preheat temperature for 30 minutes. After this time has elapsed, an audible signal will sound, and the oven will turn off.

NOTE:

1. To program only preheat, touch the START pad after step 2. Preheating will start. When the oven reaches the programmed temperature, follow the indicated message.
2. To preheat and cook with the different temperatures, touch CONVECTION and enter temperature after Step 2.

MANUAL COOKING

MICROWAVE TIME COOKING

Your oven can be programmed for 99 minutes 99 seconds (99.99). Always enter the seconds after the minutes, even if they are both zeros.

- Suppose you want to cook for 5 minutes at 100%.

PROCEDURE

1 Enter cooking time. 

2 Touch **START**. 

TO SET POWER LEVEL

There are eleven preset power levels.

Using lower power levels increases the cooking time which is recommended for foods such as cheese, milk and long slow cooking of meats. Consult cookbook or recipes for specific recommendations.

TOUCH POWER LEVEL PAD	APPROXIMATE PERCENTAGE OF POWER	COMMON WORDS FOR POWER LEVELS
once	100%	High
twice	90%	
3 times	80%	
4 times	70%	Medium High
5 times	60%	
6 times	50%	Medium
7 times	40%	
8 times	30%	Med Low/Defrost
9 times	20%	
10 times	10%	Low
11 times	0%	

- Suppose you want to defrost for 5 minutes at 30%.

PROCEDURE

1 Enter cooking time. 

2 Touch **POWER LEVEL** 8 times or hold down until the desired power level appears.  x 8

3 Touch **START**. 

If you wish to know power level, simply touch **POWER LEVEL**. As long as your finger is touching **POWER LEVEL**, the power level will be displayed.

AUTOMATIC COOKING

SPEED COOKING

The 84 basic foods and 100 recipes are cooked with SHARP'S new high speed hot air system. Follow the directions below and those in the Interactive Display to ensure perfectly cooked foods.

Caution:

The oven cabinet, cavity, door, turntable, turntable support, rack and dishes will become hot. To PREVENT BURNS, use thick oven gloves when removing the food or turntable.

BASIC COOK

The 84 preprogrammed basic foods are grilled, roasted or baked to perfection. Note they are in nine categories. See the chart on pages 16 to 18 for the specific foods. There are 2 ways to select your favorite food. One is selecting from the food category and other is entering the specific food number.

Operation 1: Select food from the food category.

- Suppose you want to roast a 5 pound chicken.

PROCEDURE

1 To select food category, touch **BASIC COOK** repeatedly. See chart below. Touch **BASIC COOK** 2 times to select the Poultry category. Note that the red indicator to the left of Poultry is lighted.



2 Touch the **UP** or **DOWN** arrows to select desired food. (Example: Touch the **UP** arrow 3 times for CHICKEN WHOLE.)



3 Touch desired numbers to enter quantity. (Ex: touch **5** and **0** for 5 pounds.)

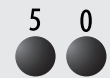

4 Put chicken on low rack over splash guard in the oven.

5 Touch **START**.



TOUCH BASIC COOK	FOOD CATEGORY
Once	Meats
Twice	Poultry
3 times	Fish/Seafood
4 times	Casseroles
5 times	Pizzas
6 times	Appetizers/Snacks
7 times	Pies
8 times	Desserts
9 times	Cakes/Breads

Operation 2: Select food by entering the specific food number.

- Suppose you want to roast a 5 pound chicken. (food number 17- CHICKEN WHOLE)

PROCEDURE

1 Touch **BASIC COOK**.



2 Enter desired food number from the chart on pages 16 to 18. (Ex. Touch **1** and **7** to select CHICKEN WHOLE)

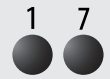

3 Touch **ENTER**.



4 Touch desired numbers to enter quantity. (Ex: touch **5** and **0** for 5 pounds.)

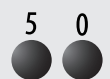

5 Put chicken on low rack over splash guard in the oven.

6 Touch **START**.



NOTE:

- It may not be necessary to enter weight or quantity for some foods. It may be necessary to select 1 level or 2 levels. Follow the Interactive Display directions to ensure perfect cooking results.
- The Interactive Display also advises if a high rack or low rack is needed.
- When the indicator above **CUSTOM HELP** is lighted, press **CUSTOM HELP** for additional information to assist you.
- You can adjust cooking time as you like. See **AUTOMATIC COOKING TIME ADJUSTMENT** on page 28.
- The Basic Cook numbers are from 1 to 84. See pages 16-18 for the desired basic cook and enter that number. Should you enter a number greater than 84, the display will show **ERROR**.
- If you attempt to enter more or less than the allowed amount as indicated in chart, an error message will appear in the display.
- Be sure to use the recommended container in the chart and Interactive Display.

If arcing occurs, place a heat resistant dish (Pyrex pie plate, glass pizza dish or dinner plate) between the pan and the turntable or rack. If arcing occurs with other metal baking utensils, discontinue their use for cooking.

AUTOMATIC COOKING

BASIC COOK CHART

MEATS

Number	BEEF		Amount	Rack	Container	Splash guard
1	Frankfurters*		1 - 6 pieces	low	pizza pan	
2	Hamburgers 1/4 pound each	medium, well	2 - 6 pieces	low		yes
3	Meat loaf		1 - 2 pounds		glass loaf dish	
4	Roast tender cut, boneless	rare, medium	2.5 - 4 pounds	low		yes
5	Steaks, bone-in 1-inch thick	rare, medium	1 - 3 pounds	low		yes
6	Steaks, boneless 1-inch thick	rare, medium	.5 - 2 pounds	low		yes
Number	LAMB		Amount	Rack	Container	Splash guard
7	Chops, bone-in 3/4-1-inch thick	medium	.5 - 1.5 pounds	low		yes
8	Roast, boneless	medium	2.5 - 4 pounds	low		yes
Number	PORK		Amount	Rack	Container	Splash guard
9	Chops, bone-in 1/2-3/4-inch thick		.5 - 2 pounds	low		yes
10	Chops, boneless 1-inch thick*		.3 - 2 pounds	low		yes
11	Roast, loin boneless		2 - 3.5 pounds	low		yes
12	Roast, tenderloin		1.2 - 2 pounds		pizza pan	
13	Sausage		.3 - 1 pound	low		yes
14	Smoked ham slice		1 slice	low		yes

POULTRY

Number	CHICKEN		Amount	Rack	Container	Splash guard
15	Breasts, boneless		.5 - 2 pounds	low		yes
16	Pieces, bone-in		.5 - 3 pounds	low		yes
17	Whole		2.5 - 7 pounds	low		yes
Number	CONVENIENCE CHICKEN		Amount	Rack	Container	Splash guard
18	Nuggets, frozen	1 level	.3 - 1.3 pounds		pizza pan	
		2 levels	1.4 - 2 pounds	high	2 pizza pans	
19	Nuggets, refrigerated	1 level	.3 - 1.3 pounds		pizza pan	
		2 levels	1.4 - 2 pounds	high	2 pizza pans	
20	Patties, frozen	1 level	.3 - 1.3 pounds		pizza pan	
		2 levels	1.4 - 2 pounds	high	2 pizza pans	
21	Patties, refrigerated	1 level	.3 - 1.3 pounds		pizza pan	
		2 levels	1.4 - 2 pounds	high	2 pizza pans	
22	Pieces, bone-in frozen	1 level	.5 - 1.5 pounds		pizza pan	
		2 levels	1.6 - 3 pounds	high	2 pizza pans	
23	Tenders, frozen	1 level	.3 - 1.3 pounds		pizza pan	
		2 levels	1.4 - 2 pounds	high	2 pizza pans	
24	Tenders, refrigerated	1 level	.3 - 1.3 pounds		pizza pan	
		2 levels	1.4 - 2 pounds	high	2 pizza pans	
25	Wings, frozen	1 level	.5 - 2 pounds		pizza pan	
		2 levels	2.1 - 3 pounds	high	2 pizza pans	
26	Wings, refrigerated	1 level	.5 - 2 pounds		pizza pan	
		2 levels	2.1 - 3 pounds	high	2 pizza pans	
Number	TURKEY		Amount	Rack	Container	Splash guard
27	Breast, bone-in		3 - 6 pounds	low		yes
28	Breast, boneless		1.5 - 3 pounds	low		yes

FISH / SEAFOOD

Number	Food		Amount	Rack	Container	Splash guard
29	Fillets*		.3 - 1.5 pounds	high	pizza pan	
30	Pieces, prepared frozen	1 level	.3 - 1.5 pounds		pizza pan	
		2 levels	1.6 - 2.5 pounds	high	2 pizza pans	
31	Shellfish*		.3 - 1.5 pounds	high	pizza pan	
32	Steaks, 1-inch thick		.5 - 1.5 pounds	low		
33	Sticks, prepared frozen	1 level	.3 - 1.3 pounds		pizza pan	
		2 levels	1.4 - 1.5 pounds	high	2 pizza pans	

*This food choice requires a preheated oven. Be sure to wait until the preheat is over before putting the food in the oven.

AUTOMATIC COOKING

CASSEROLES

Number	Food	Amount	Rack	Container	Splash guard
34	Baked	1 level		8-inch square dish	
35	Lasagna	2 levels	high	2 (8-inch) square dishes	
36	Macaroni and Cheese	1 level		8-inch square dish	
		2 levels	high	2 (8-inch) square dishes	
37	Real baked potatoes	1 - 4		pizza pan	

PIZZA

Number	Food	Amount	Rack	Container	Splash guard
38	Boboli	1 pizza	low		
39	Deli fresh*	1 pizza	low		
40	Pizza crust, from a mix*	1 pizza	low	pizza pan	
41	Pizza crust, refrigerated*	1 pizza	low	pizza pan	
42	Regular crust, frozen*	1 pizza	low		
43	Reheat, refrigerated leftover	1 - 4 slices	low		
44	Rising crust, frozen*	1 pizza	high		

APPETIZER SNACKS FROZEN

Number	Food	Amount	Rack	Container	Splash guard
45	Bagel bites*	7 - 14 ounces	low	pizza pan	
46	Burritos or Chimichangas*	1 - 4 pieces		pizza pan	
47	Cheese sticks*	8 - 10 ounces	low	pizza pan	
48	Corn dogs*	1 - 6 pieces		pizza pan	
49	Eggplant sticks*	6 - 10 ounces	low	pizza pan	
50	Egg rolls*	1 - 4 pieces		pizza pan	
51	French fries	1 level	.3 - 1 pound	high	pizza pan
		2 levels	2 pounds	high	2 pizza pans
52	Hash brown potato patties	1 level	1 - 6 patties	high	pizzapan
		2 levels	12 patties	high	2 pizza pans
53	Mini egg rolls*	6 - 8 ounces	low	pizza pan	
54	Mini tacos*	10 - 12 ounces	low	pizza pan	
55	Onion rings*	1 level	.3 - .6 pound	high	pizza pan
		2 levels	.7 - 1 pound	high	2 pizza pans
56	Pocket sandwiches*	1 - 4 pieces		pizza pan	
57	Sausage and biscuits*	2 - 6 pieces		pizza pan	
58	Taquitos*	24 ounces	low	pizza pan	
59	Tater tots	1 level	.3 - 1 pound		pizza pan
		2 levels	2 pounds	high	2 pizza pans
60	Toasted raviolis*	12 - 15 ounces	low	pizza pan	

PIES

Number	Food	Amount	Rack	Container	Splash guard
61	Cobbler, frozen	1	low	metal pan	
62	Pie crust in glass dish*	1	low	glass pie plate	
63	Pie crust in metal pan*	1		metal pie pan	
64	Pie, frozen fruit	1	low	metal pie pan	

DESSERTS

Number	Food	Amount	Rack	Container	Splash guard
65	Brownies from a mix	2 levels	high	2 (8-inch) square pans	
66	Cookies, frozen baked at 350°F	1 - 2 levels	1 level on low rack 2 levels on turntable and high rack	pizza pan	
67	Cookies, frozen baked at 375°F	1 - 2 levels		pizza pan	
68	Cookies, refrigerated baked at 325°F*	1 - 2 levels		pizza pan	
69	Cookies, refrigerated baked at 350°F	1 - 2 levels		pizza pan	

*This food choice requires a preheated oven. Be sure to wait until the preheat is over before putting the food in the oven.

AUTOMATIC COOKING

CAKES / BREADS

Number	CAKE	Amount	Rack	Container	Splash guard
70	Angel food cake from a mix	1		tube pan	
71	Bundt from a mix, baked at 350°F	1	low	Bundt pan	
72	Bundt from a mix, baked at 375°F	1	low	Bundt pan	
73	Layer from a mix*	1 - 2 layers	1 layer on turntable and 2 layers on turntable and high rack	8-inch pan(s)	
74	Cupcakes from a mix*	2 levels	high	2 6-cup muffin pans	
Number	QUICK BREAD	Amount	Rack	Container	Splash guard
75	Biscuits from a mix	1 level	low	pizza pan	
76	Biscuits, frozen	1 - 2 levels	1 level on low rack 2 levels on turntable and high	pizza pan	
77	Biscuits, refrigerated	1 - 2 levels		pizza pan	
78	Crescent rolls, refrigerated	1 package		pizza pan	
79	Loaf from a mix	1 loaf		loaf pan	
80	Muffins from a mix	2 levels	high	2 (6-cup) muffin pans	
81	Sweet rolls, refrigerated	1 package	low	pizza pan	
82	Breadsticks, refrigerated	1 package	high	2 pizza pans	
83	Garlic loaf, frozen	1		pizza pan	
84	Loaf, refrigerated	1		pizza pan	

*This food choice requires a preheated oven. Be sure to wait until the preheat is over before putting the food in the oven.



AUTOMATIC COOKING

RECIPES

There are 100 great recipes in the SHARP HIGH SPEED CONVECTION MICROWAVE OVEN COOKBOOK. All recipes are preprogrammed with SHARP'S new technology with high speed hot air, so you can get perfect result in a shorter time. Note they are in nine categories. See the chart on pages 20 to 22 and follow the directions in the cookbook. There are 2 ways to select your favorite recipe. One is selecting from the food category and other is the entering the specific recipe number.

Operation 1: Select recipe from food category.



- Suppose you want to cook Deluxe Roasted Chicken.

PROCEDURE	
<p>1 To select food category, touch RECIPES repeatedly. See chart below. Touch RECIPES 2 times to select the Poultry category. Note that the red indicator to the left of Poultry is lighted.</p>	
<p>2 Touch the UP or DOWN arrows to select desired recipe. (Example: Touch UP arrow 4 times for DELUXE ROASTED CHICKEN.)</p>	
<p>3 Follow the display and the cookbook instructions.</p>	
<p>4 Touch START.</p>	

TOUCH RECIPES	FOOD CATEGORY
Once	Meats
Twice	Poultry
3 times	Fish/Seafood
4 times	Casseroles
5 times	Pizzas
6 times	Appetizers/Snacks
7 times	Pies
8 times	Desserts
9 times	Cakes/Breads

Operation 2: Select recipe by entering the specific recipe number.

- Suppose you want to cook Deluxe Roasted Chicken. (recipe number 20).

PROCEDURE	
<p>1 Touch RECIPES.</p>	
<p>2 Enter desired recipe number from the chart. (Ex. Touch 2 and 0 to select DELUXE ROASTED CHICKEN.)</p>	
<p>3 Touch ENTER.</p>	
<p>4 Follow the display and the cookbook instructions.</p>	
<p>5 Touch START.</p>	

NOTE:

1. The Interactive Display also advises if a high rack or low rack is needed.
2. When the indicator above **CUSTOM HELP** is lighted, press **CUSTOM HELP** for additional information to assist you.
3. You can adjust cooking time as you like. See **AUTOMATIC COOKING TIME ADJUSTMENT** on page 28.
4. The Recipe numbers are from 1 to 100. See pages 20-22 for the desired recipe and enter that number. Should you enter a number greater than 100, the display will show **ERROR**.
5. Be sure to use the recommended container in the cookbook and Interactive Display. If arcing occurs, place a heat resistant dish (Pyrex pie plate, glass pizza dish or dinner plate) between the pan and the turntable or rack. If arcing occurs with other metal baking utensils, discontinue their use for cooking.

AUTOMATIC COOKING

RECIPES

MEATS

Number	Food	Rack	Container	Splash guard	Cookbook page
1	Apricot Pork Roast	low		Yes	30
2	Barbecued Steaks	low		Yes	35
3	Beef and Bean Wheels	low	pizza pan		36, 37
4	Chinese Pork Chops	low	10-inch square casserole		31
5	Crispy Franks	low	pizza pan		34
6	Glazed Ham Slice	low	10-inch square casserole		30
7	Glazed Veal Chops	low		Yes	33
8	Heavenly Hamburgers	low		Yes	35
9	Meat Loaf Surprise		9x5 glass loaf dish		34
10	Oriental Flank Steak	low		Yes	28
11	Pork Tenderloin with Herbs		pizza pan		31
12	Sour Cream Burgers	low		Yes	34
13	Spareribs with Plum Glaze	low	10-inch square casserole (1-2 stage)	Yes (3-4 stage)	37
14	Steak Kabobs	low		Yes	30, 32
15	Sweet and Sour Lamb Chops	low	2qt casserole		31
16	Zesty Pork Tenderloin		pizza pan		28, 29

POULTRY

Number	Food	Rack	Container	Splash guard	Cookbook page
17	Apple Turkey Breast	low	8-inch square glass dish		43
18	Caribbean Chicken Breasts	low		Yes	46
19	Crunchy Garlic Chicken	low	3qt casserole		46
20	Deluxe Roasted Chicken	low		Yes	39, 41
21	Herb Grilled Chicken	low		Yes	39
22	Honey Mustard Drumsticks	low		Yes	42, 44
23	Mustard and Mayo Chicken	low		Yes	46
24	Onion Chicken Fingers*	low	pizza pan		43, 45
25	Roasted Turkey Breast	low		Yes	42
26	Savory Roast Chicken	low		Yes	42
27	Sesame Oven-Fried Chicken	low	pizza pan		43
28	Stuffed Chicken Breasts		8-inch square glass dish		40

FISH / SEAFOOD

Number	Food	Rack	Container	Splash guard	Cookbook page
29	Fish Steaks with Herbs	low	pizza pan		50
30	Italian Shrimp*	high	pizza pan		54
31	Lemon Buttered Sole*	low	10-inch square casserole		55
32	Old Bay Grilled Fish*	high	pizza pan		54
33	Pineapple Salsa Swordfish	low	pizza pan		49, 51
34	Salmon with Basil Sauce	low	pizza pan		54
35	Salmon with Tomatoes*	low	10-inch square casserole		50, 53
36	Savory Baked Fish*	high	pizza pan		51
37	Scallop Kabobs*	high	pizza pan		50, 52
38	Shrimp de Jonghe*	low	10-inch round casserole		55
39	Spicy Shrimp*	high	pizza pan		48
40	Teriyaki Fish Fillets*	high	pizza pan		51

*This recipe requires a preheated oven. Be sure to wait until the preheat is over before putting the food in the oven.

AUTOMATIC COOKING

CASSEROLES

Number	Food	Rack	Container	Splash guard	Cookbook page
41	Baked Shrimp Salad*	low	9-inch pie plate		59
42	Chicken Linguine Casserole		8-inch square glass dish		63
43	Citrus Treasure Fish*	low	2.5qt casserole		58
44	Crustless Chicken Quiche	low	9-inch pie plate		63
45	Grilled Vegetables	2 levels high	2 pizza pans		59, 60
46	Macaroni and Blue Cheese		8-inch square glass dish		63
47	Mexicali Corn Pudding	low	10-inch square casserole		58
48	Mushroom Lasagna	2 levels high	2(8-inch) square glass dishes		64
49	Party Roasted Potatoes	low	pizza pan		59, 61
50	Pasta with Squash and Shallots	low	pizza pan		62
51	Stuffed Peppers		10-inch casserole		56, 58
52	Tamale Casserole		2qt casserole		62

PIZZA

Number	Food	Rack	Container	Splash guard	Cookbook page
53	Brie and Cranberry Pizza*	low	pizza pan		23
54	Chewy Pizza Bread*	low	8-inch square glass dish		26
55	Grecian Potato Pizza*	low	pizza pan		26
56	Hail Caesar Pizza*	low	pizza pan		23
57	Hawaiian Barbeque Pizza*	low			23, 25
58	Pesto Pizza*	low	pizza pan		24

APPETIZER AND SNACKS

Number	Food	Rack	Container	Splash guard	Cookbook page
59	Artichoke Crab Spread*	low	9-inch glass pie plate		19
60	Bean and Cheese Dip		9-inch glass pie plate		16
61	Buffalo Chicken Wings	low	pizza pan		16
62	Cheesy Spinach Nuggets	2 levels high	2 pizza pans		18
63	Grilled Portabella Appetizers*	low			18, 20
64	Pistachio Camembert Tart		pizzapan		19
65	Rosy Baked Brie	low	flat glass dish		16, 17
66	Smoky Pigs in Blankets	2 levels high	2 pizza pans		16
67	Spicy Appetizer Nuts	low	pizza pan		18
68	Veggie Nachos	low	10-inch glass pie plate		19, 21

PIES / PASTRY

Number	Food	Rack	Container	Splash guard	Cookbook page
69	Apple Berry Pie*		9-inch pie plate		88
70	Caramel Pecan Pie*	low	9-inch pie plate		91
71	Coconut Oatmeal Pie	low	9-inch pie plate		94
72	Cracker Pie*	low	9-inch pie plate		94
73	Fresh Fruit Tart*	low	pizza pan		90, 93
74	Fudge Brownie Pie	low	9-inch pie plate		89, 90
75	Graham Cracker Pie*	low	9-inch pie plate		94
76	Pear Praline Pie	low	9-inch pie plate		91, 92

DESSERTS

Number	Food	Rack	Container	Splash guard	Cookbook page
77	Autumn Treasure Cookies	2 levels high	2 pizza pans		80, 81
78	Baked Apples Imperial		2qt casserole		82, 84
79	Brownie Pizza*	low	pizza pan		83, 85
80	Carousel Crackles	2 levels high	2 pizza pans		83
81	Cookie Apple Cobbler*	low	8-inch square glass dish		86
82	Gingered Peach and Pear Crisp*	low	8-inch round glass dish		80
83	Maple Bread Pudding	low	8-inch square glass dish		86
84	Pumpkin Bars	2 levels high	2 (8-inch) square pans		82

*This recipe requires a preheated oven. Be sure to wait until the preheat is over before putting the food in the oven.

AUTOMATIC COOKING

CAKES / BREADS

Number	Food	Rack	Container	Splash guard	Cookbook page
85	Banana Apricot Bran Bread	low	9X5-inch glass loaf dish		78
86	Banana Carrot Muffins 2 levels	high	2 (6-cup) muffin pans		78
87	Banana Streusel Loaf		9X5-inch glass loaf dish		69, 70
88	Blueberry Monkey Bread	low	8-inch square glass dish		73
89	Cinnamon Date Scones 2 levels	high	2 pizza pans		66, 68
90	Cinnamon Swirl Pound Cake	low	10-inch tube pan, glass plate		77
91	Classic Cheesecake	low	9-inch round glass dish		74
92	Classic Cranberry Tea Cake	low	12-cup bundt pan, glass plate		77
93	Green Onion Biscuits	low	pizza pan		71, 72
94	Herb Biscuits 2 levels	high	2 pizza pans		72
95	No Knead Cheddar Dill Bread	low	8-inch round cake pan		76
96	Nut Cake with Mocha Cream 2 levels	high	2 (8-inch) round cake pans		76
97	Quick Sticky Rolls 1 level	low	8-inch round cake pan		67, 68
98	Very Berry Bundt Cake	low	10-cup bundt pan, glass plate		74, 75
99	Yummy Blueberry Muffins 2 level	high	2 (6-cup) muffin pans		69
100	Zucchini Muffins 2 level	high	2 (6-cup) muffin pans		73

AUTOMATIC COOKING

MICROWAVE OPTIONS





There are 17 microwave settings, including POPCORN REHEAT, COMPUCOOK and COMPUDEFROST.

POPCORN

The popcorn setting automatically provides the correct cooking time for most brands of microwave popcorn. See the chart below.

- Suppose you want to pop a 3.5 ounce bag of regular popcorn.







PROCEDURE	
1 Touch POPCORN once.	

2 Select desired type of popcorn by touching UP  or DOWN  arrows.	  or
3 Touch START .	START 

Popcorn can be programmed with AUTOMATIC COOKING TIME ADJUSTMENT. See page 28.

Use an overturned 9 or 10 inch oven proof glass pie plate on top of the turntable when popping bagged microwave popcorn.

POPCORN CHART







FOOD	AMOUNT	PROCEDURE
POPCORN	1 bag	Try several brands to decide which is most acceptable for your taste. Unfold bag and place in oven according to directions.
	3.5 oz bag (Regular)	Touch POPCORN once and UP  or DOWN  arrows until REGULAR 3.5 OZ is displayed.
	2.85 - 3.5 oz bag (Regular Light)	Touch POPCORN once and UP  or DOWN  arrows until REGULAR LIGHT 2.85 - 3.5 OZ is displayed.
	1.5 - 1.75 oz (Snack)	Touch POPCORN once and UP  or DOWN  arrows until SNACK 1.5 - 1.75 OZ is displayed.

AUTOMATIC COOKING

REHEAT / COMPU COOK

Reheat and CompuCook automatically compute the correct warming or cooking time and microwave power level for foods shown in the charts on page 24 and 25.

- Suppose you want to heat 2 cups of soup.

PROCEDURE	
1 Touch REHEAT once.	
2 Select desired food by touching UP  or DOWN  arrows.	 or 
3 Touch desired number to select quantity. (Ex: Touch 2 for 2 cups.)	
4 Touch START .	

NOTE:

1. To reheat or cook other foods above or below the quantity allowed on the Reheat Chart or CompuCook Chart, cook manually.
2. You can adjust cooking result as you like. Refer to **AUTOMATIC COOKING TIME ADJUSTMENT** on page 28.

COMPU COOK CHART

FOOD	AMOUNT	PROCEDURE
1. Baked Potatoes	1 - 4 med.	Pierce with fork in several places. Place on paper towel on turntable. After cooking, remove from oven and let stand wrapped in foil for 5 to 10 minutes.
2. Fresh Vegetables	1 - 4 cups	For beans, carrots, corn and peas, add 1 tablespoon of water per cup. Cover with lid. For broccoli, Brussel sprouts, cabbage and cauliflower, cook immediately after washing with no additional water. Cover with plastic wrap. If you like tender crisp vegetables, double measured quantity per setting. For example, use 2 cups cauliflower and program for 1 cup. After cooking, remove from oven, stir, cover and let stand 3 to 5 minutes before serving.
3. Frozen Entrees	6 - 17 oz.	Use for frozen, convenience foods. It will give satisfactory results for most brands. You may wish to try several and choose your favorite. Remove package from outer wrapping and follow package directions for covering. After cooking, let stand covered for 1 to 3 minutes.
4. Frozen Vegetables	1 - 4 cups	Add no water. Cover with lid or plastic wrap. After cooking, stir and let stand, covered, for 3 minutes.
5. Ground Meat	.3 - 1.5 lb	Use this setting to cook ground beef or turkey as patties or in a casserole to be added to other ingredients. Place patties on a microwave-safe rack and cover with wax paper. Place ground meat in a casserole and cover with wax paper or plastic wrap. When oven stops, turn patties over or stir meat in casserole to break up large pieces. Re-cover and touch START . After cooking, let stand, covered for 2 to 3 minutes.

REHEAT CHART

FOOD	AMOUNT	PROCEDURE
1. Beverage	.5 - 2 cups	This setting is good for restoring cooled beverage to a better drinking temperature. Stir after heating.
2. Casserole	1 - 4 cups	Use to reheat refrigerated canned or homemade pasta with sauce or other cooked casserole. For room temperature pasta or casserole, use Less option. For pasta without sauce double the quantity per setting. For example, measure 2 cups of cooked noodles and program for 1 cup. Cover with lid or plastic wrap. After cooking, stir and let stand, covered, 2 to 3 minutes.
3. Dinner Plate	1plate (regular)	Use to reheat precooked foods from the refrigerator. Place meaty portions and bulky vegetables to outside of plate. Cut large items like baked potatoes in smaller pieces. Flatten foods such as mashed potatoes and other dense foods. Cover with wax paper or plastic wrap. ONE PLATE ONLY. After cooking, check that food is very hot throughout and that the bottom center of the plate is very hot. If not, continue heating using time and power level. Allow to stand, covered, 1 to 2 minutes. A regular amount of food: approximately 4 oz. sliced meat or poultry, 1/2 cup potato or rice and 1/2 cup of vegetables or equivalent.
4. Fresh Rolls/Muffins	1 - 6 pcs.	Use to warm rolls, muffins, biscuits, bagels etc. Large item should be considered as 2 regular size. Cover each roll/muffin with paper towel. For refrigerated rolls or muffins, it may be necessary to double the entered amount to ensure the proper serving temperature. For example, enter quantity of 2 for 1 refrigerated muffin.
5. Soup	1 - 4 cups	Place in bowl or casserole. Cover with lid or plastic wrap. At end, stir, re-cover and let stand 1 to 3 minutes.

AUTOMATIC COOKING



COMPU DEFROST



CompuDefrost automatically defrosts ground meat, steaks, chops, fish and poultry.

• Suppose you want to defrost a 2.0 pound steak.

PROCEDURE

1 Touch **COMPU DEFROST**. 

2 Select desired food by touching **UP**  or **DOWN**  arrows. or

3 Enter weight by touching the number pads **2**  and **0** . (Ex. 2.0 lbs steak)

4 Touch **START**. 

The oven will stop so that the food can be checked.

5 After the 1st stage, open the door. Turn steak over and shield any warm portions. Close the door. Touch **START**. 

6 After the 2nd stage, open the door. Shield any warm portions. Close the door. Touch **START**. 

7 After defrost cycle ends, cover and let stand as indicated in chart below.

NOTE:

1. If you attempt to enter more or less than the allowed amount, ERROR will appear in the display.
2. CompuDefrost can be programmed with AUTOMATIC COOKING TIME ADJUSTMENT. See page 28.
3. To defrost other foods or foods above or below the weights allowed on CompuDefrost Chart below, use time and 30% power. See Manual Defrost on page 27.

COMPU DEFROST CHART

FOOD	AMOUNT	PROCEDURE
1. Bone-in Poultry	.5 - 3.0 lbs	Arrange pieces with meatiest portions toward outside of glass dish or microwave safe rack. After each stage, if there are warm or thawed portions, rearrange or remove. Let stand, covered, for 10 to 20 minutes.
2. Boneless Poultry	.5 - 2.0 lbs	Use boneless breast of chicken or turkey. After each stage, if there are warm or thawed portions, rearrange or remove. Let stand, covered, for 5 to 10 minutes.
3. Ground Meat	.5 - 2.0 lbs	Remove any thawed pieces after each stage. Let stand, covered, 5 to 10 minutes.
4. Steaks/Chops	.5 - 3.0 lbs	After each stage of defrost cycle, rearrange and if there are warm or thawed portions, shield with small flat pieces of aluminum foil. Remove any meat or fish that is nearly defrosted. Let stand, covered, 10 to 20 minutes.

NOTE: Check foods when oven signals. After final stage, small sections may still be icy. Let stand to continue thawing. Do not defrost until all ice crystals are thawed. Shielding prevents cooking from occurring before the center of the food is defrosted. Use small smooth strips of aluminum foil to cover edges and thinner sections of the food.

MANUAL DEFROST

If the food that you wish to defrost is not listed on the COMPU DEFROST CHART or is above or below the limits in the "Amount" column on the COMPU DEFROST CHART, you need to defrost manually.

You can defrost any frozen food, either raw or previously cooked, by using 30% Power Level. See page 14. Estimate defrosting time and touch **POWER LEVEL** 8 times for 30% when you select the power level.

For either raw or previously cooked frozen food the rule of thumb is approximately 4 minutes per pound. For example, defrost 4 minutes for 1 pound of frozen spaghetti sauce.

Always stop the oven periodically to remove or separate the portions that are defrosted. If food is not defrosted at the end of the estimated defrosting time, program the oven in 1 minute increments at 30% until totally defrosted.

When using plastic containers from the freezer, defrost only long enough to remove from the plastic in order to place in a microwave-safe dish.

OTHER CONVENIENT FEATURES

DEMONSTRATION MODE

To demonstrate, touch **CLOCK**, the number **0** and touch **START** and hold for 3 seconds. **DEMO ON** will appear in the display. Cooking operations and specific special features can now be demonstrated with no power in the oven. For example, touch **MINUTE PLUS** and the display will show **1.00** and count down quickly to **END**.

To cancel, touch **CLOCK**, then the number **0** and **STOP/CLEAR**. If easier, unplug the oven from the electrical outlet and replug.

AUTOMATIC COOKING TIME ADJUSTMENT

The cooking results may slightly vary depending on room temperature, initial food temperature and other factors. You can adjust cooking results as you like.

MORE / LESS TIME ADJUSTMENT BEFORE START

Should you discover that you like any of the Automatic Cooking Options slightly **more** done, touch the **POWER LEVEL** once before **START**.

The display will show **MORE**.

Should you discover that you like any of the Automatic Cooking Options slightly **less** done, touch the **POWER LEVEL** twice before **START**.

The display will show **LESS**.

EXTEND DURING COOKING

MINUTE PLUS can be used to add up to 10 minutes during cooking. Touch **MINUTE PLUS** repeatedly to extend cooking time in multiples of 1 minute. Carefully check the cooking doneness throughout the cooking time.

EXTEND AT THE COOKING END

When you open the door after the cooking, the display show **IF YOU NEED EXTRA TIME, ENTER COOKING TIME** for 3 minutes. Enter the desired cooking time and touch **START**. You can add up to 9 min. 99 sec. Carefully check the cooking progress.

Popcorn cannot have extended cooking time. Even if there are still unpopped kernels, do not add time.

TIMER

- Suppose you want to time a 3-minute long distance phone call.

PROCEDURE	
1 Touch TIMER and number 1 .	TIMER/CLOCK 1
2 Enter time.	3 0 0
3 Touch TIMER again.	TIMER/CLOCK

MULTIPLE SEQUENCE COOKING

The oven can be programmed for up to 4 cooking sequences for microwave only and 2 cooking sequences for convection.

Sometimes cooking directions tell you to start on one power level and then change to a different power level. Your oven can do this automatically.

- Suppose you want to cook roast beef for 5 minutes at 100% and then continue to cook for 30 minutes at 50%.

PROCEDURE	
1 First touch POWER LEVEL once for 100% power. Then enter cooking time.	POWER LEVEL x 1 5 0 0
2 Touch POWER LEVEL 6 times for 50% power. Then enter second cooking time.	POWER LEVEL x 6 3 0 0 0
3 Touch START .	START

NOTE:

1. If **POWER LEVEL** is touched once, **HIGH POWER** will be displayed.
2. If you wish to know power level, simply touch **POWER LEVEL**. As long as your finger is touching **POWER LEVEL**, the power level will be displayed.

OTHER CONVENIENT FEATURES

CUSTOM HELP

Custom Help provides 4 features that make using your oven easy because specific instructions are provided in the Interactive Display.

1. CHILD LOCK

The Child Lock prevents unwanted oven operation such as by small children. The oven can be set so that the control panel is deactivated or locked. To set, touch **CUSTOM HELP**, the number **1** and then touch **START**. Should a pad be touched, **CHILD LOCK ON** will appear in the display.

To cancel, touch **CUSTOM HELP** and **STOP/CLEAR**.

2. AUDIBLE SIGNAL ELIMINATION

If you wish to have the oven operate with no audible signals, touch **CUSTOM HELP**, the number **2** and then touch **STOP/CLEAR**.

To cancel and restore the audible signal, touch **CUSTOM HELP**, the number **2** and then touch **START**.







3. AUTO START

If you wish to program your oven to begin cooking automatically at a designated time of day, follow this procedure:

- Suppose you want to start cooking a stew for 20 minutes on 50% at 4:30. Before setting, check to make sure the clock is showing the correct time of day.

NOTE:

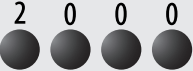
1. Auto Start can be used for manual cooking if clock is set.
2. If the oven door is opened after programming Auto Start, it is necessary to touch **START** for Auto Start time to appear in the readout so that the oven will automatically begin programmed cooking at the chosen Auto Start time.
3. Be sure to choose foods that can be left in the oven safely until the Auto Start time. Acorn or butternut squash are often a good choice.
4. If you wish to know the time of day, simply touch **CLOCK**. As long as your finger is touching **CLOCK**, the time of day will be displayed.

PROCEDURE	
1 Touch CUSTOM HELP .	CUSTOM HELP 
2 Touch number 3 .	3 
3 Enter the start time.	4 3 0 
4 Touch CLOCK .	TIMER/CLOCK 
5 Enter cooking program.	POWER LEVEL x 6 2 0 0 0 
6 Touch START .	START 

OTHER CONVENIENT FEATURES



4. REFRESH CYCLE

The oven has a special catalyst which assists with smoke and odor removal.

Use the Refresh Cycle to

- Condition the heater before using the oven the first time.
- Remove any objectionable odor.
- Keep the catalyst in optimum condition.

Follow the procedure below. The oven temperature will be maintained at 450 °F when the refresh cycle operates.

PROCEDURE	
1 Touch CUSTOM HELP .	CUSTOM HELP 
2 Touch number 4.	4 
3 Touch START .	START 

NOTE:

1. Remove the turntable from the oven before the Refresh Cycle. No food should be in the oven.
2. The Refresh Cycle is 30 minutes.
3. During the Refresh Cycle some smoke and odor may occur. Open a window or use the ventilation fan in the room.

CAUTION:

The oven door, outer cabinet and oven cavity may be hot.

HELP

When the indicator light above the CUSTOM HELP is flashing, touch the pad to read valuable information.

MINUTE PLUS

Minute Plus allows you to cook for a minute at 100% by simply touching **MINUTE PLUS**. You can also extend cooking time in multiples of 1 minute by repeatedly touching **MINUTE PLUS** during manual and automatic cooking.

- Suppose you want to heat a cup of soup for one minute.

PROCEDURE	
1 Touch MINUTE PLUS .	MINUTE PLUS 

NOTE:

1. To use Minute Plus, touch pad within 3 minutes after cooking, closing the door or touching **STOP/CLEAR**.
2. Minute Plus can be used to extend cooking times up to 10 minutes during Automatic Cooking. If you need other options see AUTOMATIC COOKING TIME ADJUSTMENT on page 28.

CLEANING AND CARE

Disconnect the power cord before cleaning or leave the door open to inactivate the oven during cleaning.

Exterior

The outside surface is precoated metal and plastic. Clean the outside with mild soap and water; rinse and dry with a soft cloth. Do not use any type of household or abrasive cleaner.

Door

Wipe the window on both sides with a damp cloth to remove any spills or spatters. Metal parts will be easier to maintain if wiped frequently with a damp cloth. Avoid the use of spray and other harsh cleaners as they may stain, streak or dull the door surface.

Stainless Steel Trim

The exterior should be wiped often with a damp cloth and polished with a soft dry cloth to maintain its beauty. There are also a variety of products designed especially for cleaning and shining the stainless exterior of the oven. We recommend that the cleaner be applied to a soft cloth and then carefully used on the stainless exterior rather than sprayed directly on to it. Follow package directions carefully.

Touch Control Panel

Wipe the panel with a cloth dampened slightly with water only. Dry with a soft cloth. Do not scrub or use any sort of chemical cleaners. Close door and touch **STOP/CLEAR**.

Interior - after microwave cooking.

Cleaning is easy because no heat is generated to the interior surfaces; therefore, there is no baking and setting of spills or spattering. To clean the interior surfaces, wipe with a soft cloth and warm water. **DO NOT USE ABRASIVE OR HARSH CLEANERS OR SCOURING PADS.** For heavier soil, use mild soap; rinse thoroughly with hot water. Do not use any chemical oven cleaners.

You may remove any lingering interior odor by using the Refresh Cycle on page 30.

Interior - after manual/automatic speed or convection cooking.

Spatters may occur because of moisture and grease. Wash immediately after use with hot, soapy water. Rinse and polish dry. Harder to remove spatters may occur if oven is not thoroughly cleaned or if there is long time/high temperature cooking. Do not use any chemical oven cleaners.

After cleaning the interior thoroughly, residual grease may be removed from the interior ducts and heaters by simply operating the oven with Refresh Cycle on page 30. Ventilate the room if necessary.

Waveguide Cover

The waveguide cover is made from mica so requires special care. Keep the waveguide cover clean to assure good oven performance. Carefully wipe with a damp cloth any food spatters from the surface of the cover immediately after they occur. Built-up splashes may overheat and cause smoke or possibly catch fire. Do not remove the waveguide cover.

Accessories

The turntable, turntable support, racks and splash guard can be removed for easy cleaning. Wash them in mild, sudsy water; for stubborn stains use a mild cleanser and a non-abrasive scouring sponge. They are also dishwasher-proof. Use upper rack of dishwasher for turntable support.

Foods with high acidity, such as tomatoes or lemons, may cause the porcelain enamel turntable and splash guard to discolor. Do not cook highly acidic foods directly on the turntable; if spills occur, wipe up immediately.

SPECIAL NOTE for TURNTABLE SUPPORT

After cooking, always clean the turntable support, especially around the rollers. These must be free from food splashes and grease. Built-up splashes or grease may overheat and cause arcing, begin to smoke or catch fire.

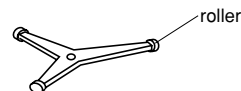

SERVICE CALL CHECK

Please check the following before calling for service:

- Place one cup of water in a glass measuring cup in the oven and close the door securely. Operate the oven for one minute at HIGH 100%.

- A** Does the oven light come on? YES _____ NO _____
- B** Does the cooling fan work?
(Put your hand over the rear ventilating openings.) YES _____ NO _____
- C** Does the turntable rotate?
(It is normal for the turntable to turn in either direction.) YES _____ NO _____
- D** Is the water in the oven warm? YES _____ NO _____

- Remove water from the oven and operate the oven for 5 minutes at CONVECTION 450° F.

- A** Do CONVEC and COOK indicators light? YES _____ NO _____
- B** After the oven shuts off, is inside of the oven hot? YES _____ NO _____

If "NO" is the answer to any of the above questions, please check electrical outlet, fuse and/or circuit breaker. If they are functioning properly, CONTACT YOUR NEAREST SHARP AUTHORIZED SERVICER. A microwave oven should never be serviced by a "do-it-yourself" repair person.

- NOTE:**
- If time appearing in the display is counting down very rapidly, check Demonstration Mode on page 28 and cancel.
 - After cooking, the cooling fan may switch on to cool the oven cavity. When the cooling fan is on, the display may show "NOW COOLING" and you will hear the sound of the cooling fan.
 - Your oven has a voltage check function. If the voltage rises above 7% or falls below 10% of the needed 240 volts, the cooking results would not be acceptable; therefore the oven will stop, display an error message and interrupt the cooking program. Press **STOP/CLEAR** and complete the cooking manually. It is imperative that the power to the oven be checked to ensure that a 240 volt circuit is serving the oven.

SPECIFICATIONS

AC Line Voltage:	Single phase 240V, 60Hz, AC only
AC Power Required:	1700W 7.5 amps. (Microwave) 3100W 13.0 amps. (Convection) 3200W 13.5 amps. (Speed Cooking)
Output Power:	
Microwave	1000W* (IEC Test Procedure)
Top Heater	1700W
Side Heater	1200W
Frequency:	2450 MHz
Outside Dimensions:	21 ⁵ / ₈ "(W) x 16"(H) x 24 ⁵ / ₈ "(D)
Cavity Dimensions**:	16 ¹ / ₈ "(W) x 8 ³ / ₈ "(H) x 13 ⁵ / ₈ "(D)
Oven Capacity**:	1.1 Cu. Ft.
Cooking Uniformity:	Turntable system, 13" diameter
Weight:	Approx. 86 lb

- ★ The International Electrotechnical Commission's standardized method for measuring output wattage. This test method is widely recognized.
- ★★ Internal capacity is calculated by measuring maximum width, depth and height. Actual capacity for holding food is less.

In compliance with standards set by:

- FCC** – Federal Communications Commission Authorized.
- DHHS** – Complies with Department of Health and Human Services (DHHS) rule, CFR, Title 21, Chapter I, Subchapter J.
-  – This symbol on the nameplate means the product is listed by Underwriters Laboratories, Inc.

NOTES

SHARP[®]

SHARP ELECTRONICS CORPORATION
Sharp Plaza, Mahwah, NJ 07430-2135

TINSE986WRRZ-D31
Printed in Thailand