



SHARP

MINI COMPONENT SYSTEM

MODEL

CD-BA250

CD-BA2600

OPERATION MANUAL

Thank you for purchasing this SHARP product.

To obtain the best performance from this product, please read this manual carefully. It will guide you in operating your SHARP product.

CD-BA250 Mini Component System consisting of CD-BA250 (main unit) and CP-BA250 (speaker system).

CD-BA2600 Mini Component System consisting of CD-BA2600 (main unit) and CP-BA2600 (speaker system).

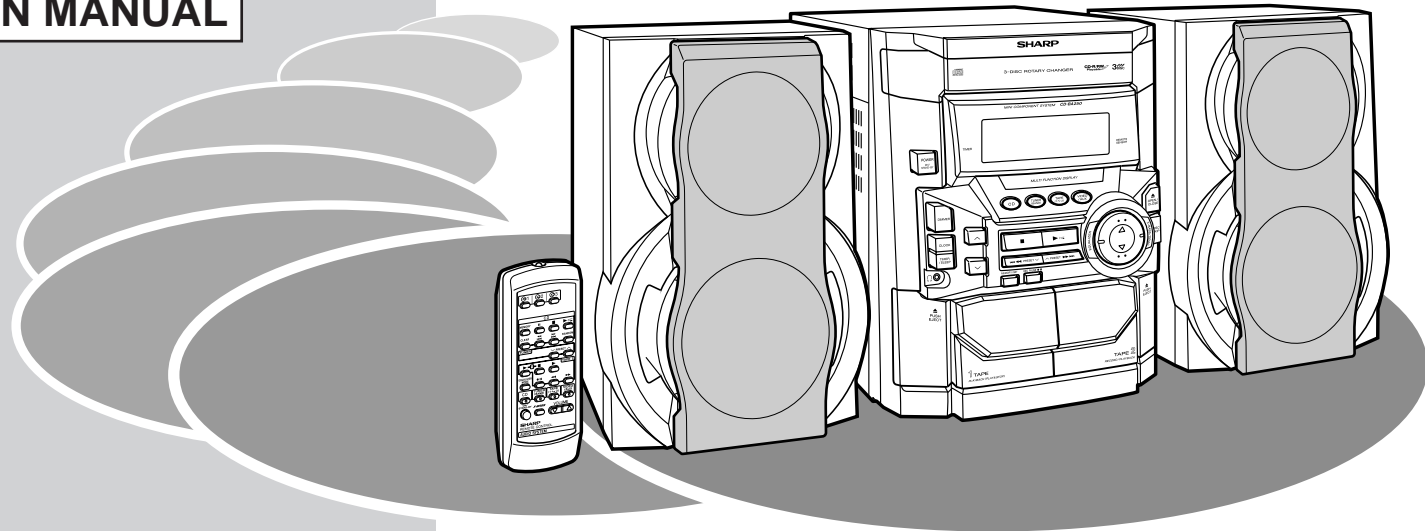

COMPACT
disc
DIGITAL AUDIO

CD-R/RW
Playable 

3000
DISC

Special Notes



CAUTION
RISK OF ELECTRIC SHOCK
DO NOT OPEN



CAUTION: TO REDUCE THE RISK OF ELECTRIC SHOCK, DO NOT REMOVE COVER (OR BACK). NO USER-SERVICEABLE PARTS INSIDE. REFER SERVICING TO QUALIFIED SERVICE PERSONNEL.

Explanation of Graphical Symbols:



The lightning flash with arrowhead symbol, within an equilateral triangle, is intended to alert the user to the presence of uninsulated "dangerous voltage" within the product's enclosure that may be of sufficient magnitude to constitute a risk of electric shock to persons.



The exclamation point within an equilateral triangle is intended to alert the user to the presence of important operating and maintenance (servicing) instructions in the literature accompanying the appliance.

WARNING: TO REDUCE THE RISK OF FIRE OR ELECTRIC SHOCK, DO NOT EXPOSE THIS APPLIANCE TO RAIN OR MOISTURE.

Caution - use of controls or adjustments or performance of procedures other than those specified herein may result in hazardous radiation exposure.

NOTE

This equipment has been tested and found to comply with the limits for a Class B digital device, pursuant to Part 15 of the FCC Rules. These limits are designed to provide reasonable protection against harmful interference in a residential installation. This equipment generates, uses, and can radiate radio frequency energy and, if not installed and used in accordance with the instructions, may cause harmful interference to radio communications. However, there is no guarantee that interference will not occur in a particular installation. If this equipment does cause harmful interference to radio or television reception, which can be determined by turning the equipment off and on, the user is encouraged to try to correct the interference by one or more of the following measures:

- Reorient or relocate the receiving antenna.
- Increase the separation between the equipment and receiver.
- Connect the equipment into an outlet on a circuit different from that to which the receiver is connected.
- Consult the dealer or an experienced radio/TV technician for help.

WARNING

FCC Regulations state that any unauthorized changes or modifications to this equipment not expressly approved by the manufacturer could void the user's authority to operate this equipment.

NOTE

It is the intent of Sharp that this product be used in full compliance with the copyright laws of the United States and that prior permission be obtained from copyright owners whenever necessary.

FOR YOUR RECORDS

For your assistance in reporting this unit in case of loss or theft, please record below the model number and serial number which are located on the rear of the unit.

Please retain this information.

Model number

Serial number

Date of purchase

Place of purchase

Important Safeguards

CAUTION

All the safety and operating instructions should be read before the appliance is operated, and should be retained for future reference.

Electrical energy can perform many useful functions. This unit has been engineered and manufactured to assure your personal safety. Improper use can result in potential electrical shock or fire hazards. In order not to defeat the safeguards, observe the following basic rules for its installation, use and servicing.

- 1 Heed Warnings - All warnings on the appliance and in the operating instructions should be adhered to.
- 2 Follow Instructions - All operating and use instructions should be followed.
- 3 Water and Moisture - The appliance should not be used near water - for example, near a bathtub, washbowl, kitchen sink, laundry tub, in a wet basement, or near a swimming pool, etc.
- 4 Carts and Stands - The appliance should be used only with a cart or stand that is recommended by the manufacturer.
 - An appliance and cart combination should be moved with care. Quick stops, excessive force, and uneven surfaces may cause the appliance and cart combination to overturn.
- 5 Wall or Ceiling Mounting - The appliance should be mounted to a wall or ceiling only as recommended by the manufacturer.
- 6 Ventilation - The appliance should be situated so that its location or position does not interfere with its proper ventilation. For example, the appliance should not be situated on a bed, sofa, rug, or similar surface that may block the ventilation openings; or, placed in a built-in installation, such as a bookcase or cabinet that may impede the flow of air through the ventilation openings.
- 7 Heat - The appliance should be situated away from heat sources such as radiators, heat registers, stoves, or other appliances (including amplifiers) that produce heat.
- 8 Power Sources - The appliance should be connected to a power supply only of the type described in the operating instructions or as marked on the appliance.
- 9 Power-Cord Protection - Power-supply cords should be routed so that they are not likely to be walked on or pinched by items placed upon or against them, paying particular attention to cords at plugs, convenience receptacles, and the point where they exit from the appliance.
- 10 Do not use liquid cleaners or aerosol cleaners. Use a damp cloth for cleaning.
- 11 Power Lines - An outdoor antenna should be located away from power lines.



- 12 Outdoor Antenna Grounding - If an outside antenna is connected to the receiver, be sure the antenna system is grounded so as to provide some protection against voltage surges and built-up static charges. Section 810 of the National Electrical Code, ANSI/NFPA No. 70-1984, provides information with respect to proper grounding of the mast and supporting structure, grounding of the lead-in wire to an antenna discharge unit, size of grounding conductors, location of antenna-discharge unit, connection to grounding electrodes, and requirements for the grounding electrode.

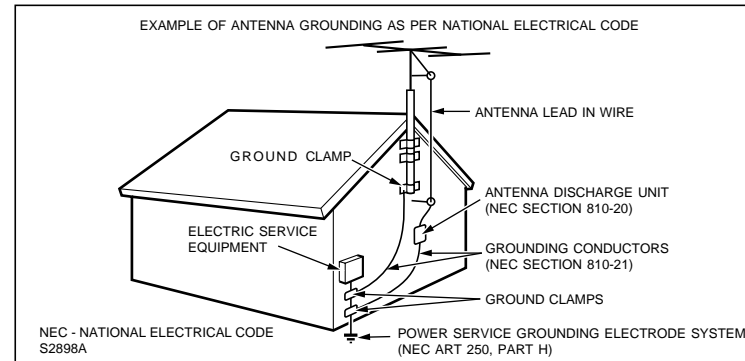

- 13 Nonuse Periods - The power cord of the appliance should be unplugged from the outlet when left unused for a long period of time.
- 14 Object and Liquid Entry - Care should be taken so that objects do not fall and liquids are not spilled into the enclosure through openings.
- 15 Damage Requiring Service - The appliance should be serviced by qualified service personnel when:
 - A The power-supply cord or the plug has been damaged; or
 - B Objects have fallen, or liquid has been spilled into the appliance; or
 - C The appliance has been exposed to rain; or
 - D The appliance does not appear to operate normally or exhibits a marked change in performance; or
 - E The appliance has been dropped, or the enclosure damaged.
- 16 Servicing - The user should not attempt to service the appliance beyond that described in the operating instructions. All other servicing should be referred to qualified service personnel.
- 17 Grounding or Polarization - Precautions should be taken so that the grounding or polarization means of an appliance is not defeated.

Contents

	Page		Page
■ General Information		■ Radio	
Accessories	4	Listening to the Radio	20
Precautions	5	Listening to the memorized station	21
Controls and Indicators	6 - 9	■ Tape Playback	
■ Preparation for Use		Listening to a Cassette Tape (TAPE 1 or TAPE 2)	22
System Connections	10, 11	■ Tape Recording	
Remote Control	12	Recording from the Radio	23
■ Basic Operation		Recording from a CD (CDs)	24
General Control	13	Dubbing from Tape to Tape	25
Sound Control	14	■ Advanced Features	
Setting the Clock	15	Timer and Sleep Operation	26, 27
■ CD Playback		Enhancing Your System	28
Listening to a CD (CDs)	16, 17	■ References	
■ Advanced CD Playback		Troubleshooting Chart	29, 30
Starting playback with a desired track	18	Maintenance	30
Repeat or Random Play	18	Specifications	31
Programmed Play	19	CONSUMER LIMITED WARRANTY	
		Back cover	

Accessories

Please confirm that the following accessories are included.

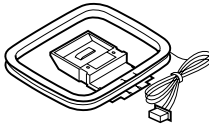
 <p>Remote control × 1 (PRMCG0264AWSA)</p>	 <p>FM/AM loop antennal × 1 (QANTL0007AWZZ)</p>
---	---

Note:

Only the above accessories are included.

Precautions

■ General

- Please ensure that the equipment is positioned in a well-ventilated area and ensure that there is at least 4" (10 cm) of free space along the sides, top and back of the unit.

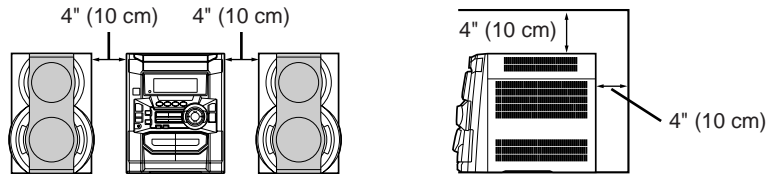

- Use the unit on a firm, level surface free from vibration.

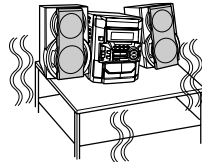

- Keep the unit away from direct sunlight, strong magnetic fields, excessive dust, humidity and electronic/electrical equipment (home computers, facsimiles, etc.) which generates electrical noise.
- Do not place anything on top of the unit.
- Do not expose the unit to moisture, to temperatures higher than 140°F (60°C) or to extremely low temperatures.
- If your system does not work properly, disconnect the AC power cord from the AC outlet. Plug the AC power cord back in, and then turn on your system.
- In case of an electrical storm, unplug the unit for safety.

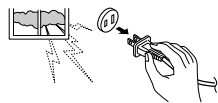
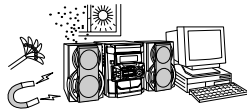

- Hold the AC power plug by the head when removing it from the AC outlet, as pulling the cord can damage internal wires.

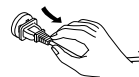

- Do not remove the outer cover, as this may result in electric shock. Refer internal service to your local SHARP service facility.

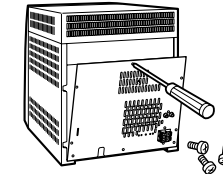

- This unit should only be used within the range of 41°F - 95°F (5°C - 35°C).

Warning:

The voltage used must be the same as that specified on this unit. Using this product with a higher voltage other than that which is specified is dangerous and may result in a fire or other type of accident causing damage. SHARP will not be held responsible for any damage resulting from use of this unit with a voltage other than that which is specified.

■ Volume control

The sound level at a given volume setting depends on speaker efficiency, location and various other factors. It is advisable to avoid exposure to high volume levels, which occur while turning the unit on with the volume control setting up high, or while continually listening at high volumes.

■ Care of compact discs

Compact discs are fairly resistant to damage, however mistracking can occur due to an accumulation of dirt on the disc surface. Follow the guidelines below for maximum enjoyment from your CD collection and player.

- Do not write on either side of the disc, particularly the non-label side from which signals are read. Do not mark this surface.
- Keep your discs away from direct sunlight, heat, and excessive moisture.
- Always hold the CDs by the edges. Fingerprints, dirt, or water on the CDs can cause noise or mistracking. If a CD is dirty or does not play properly, clean it with a soft, dry cloth, wiping straight out from the center, along the radius.

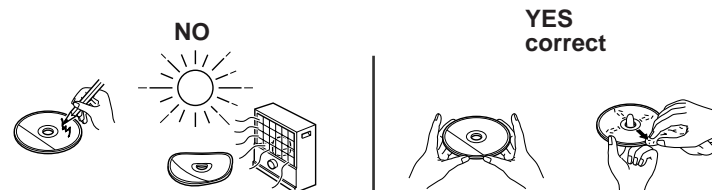

Controls and Indicators

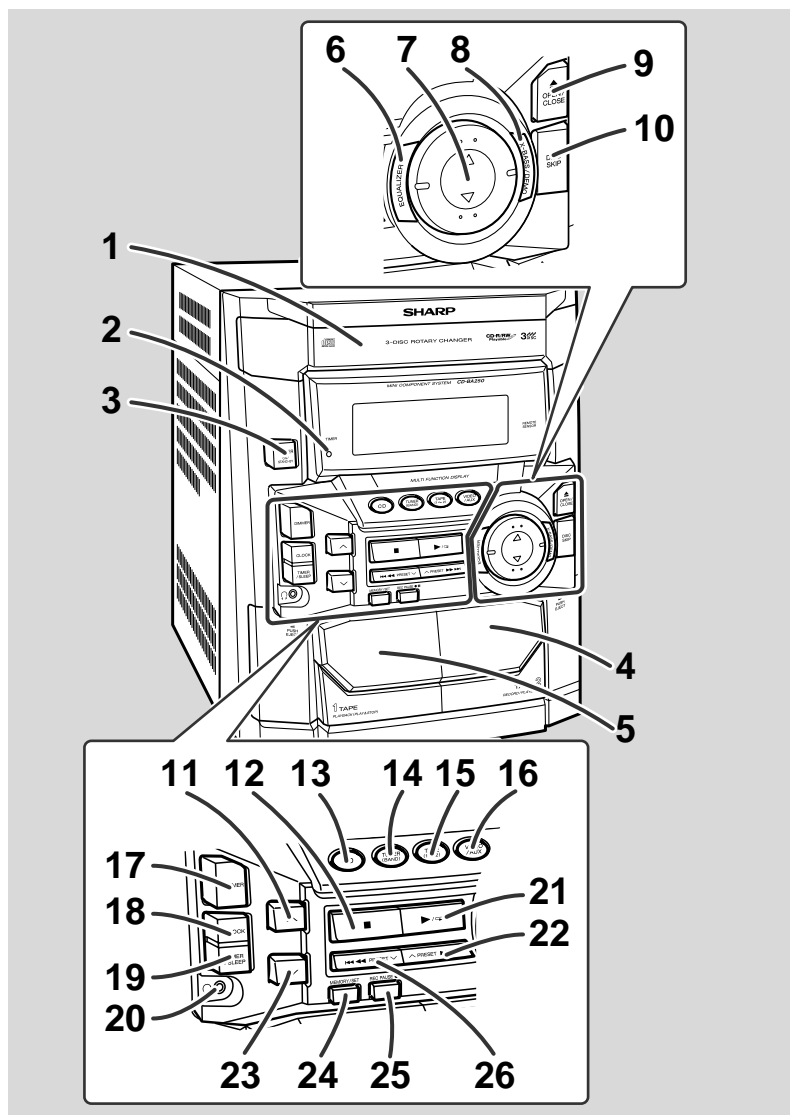

■ Front panel

	Reference page
1. Disc Tray	.16
2. Timer Set Indicator	.27
3. Power On/Stand-by Button	.15, 26, 30
4. Tape 2 Cassette Compartment	.22, 25
5. Tape 1 Cassette Compartment	.22, 25
6. Equalizer Mode Select Button	.14
7. Volume Up or Down Buttons	.14
8. Extra Bass/Demo Mode Button	.13, 14
9. Disc Tray Open/Close Button	.16
10. Disc Skip Button	.16, 18
11. Tuning and Time Up Button	.15, 20
12. CD or Tape Stop Button	.17, 22
13. CD Button	.16, 24
14. Tuner (Band) Button	.20
15. Tape (1 – 2) Button	.22, 25
16. Video/Auxiliary Button	.26, 28
17. Dimmer Button	.13
18. Clock Button	.15, 26
19. Timer/Sleep Button	.26, 27
20. Headphone Jack	.28
21. CD Play or Repeat, Tape Play Button	.17, 18, 22
22. CD Track Up or Fast Forward, Tape 2 Fast Forward, Tuner Preset Up Button	.17, 21, 22
23. Tuning and Time Down Button	.15, 20
24. Memory/Set Button	.15, 19, 21
25. Tape 2 Record Pause Button	.23, 24, 25
26. CD Track Down or Fast Reverse, Tape 2 Rewind, Tuner Preset Down Button	.17, 21, 22

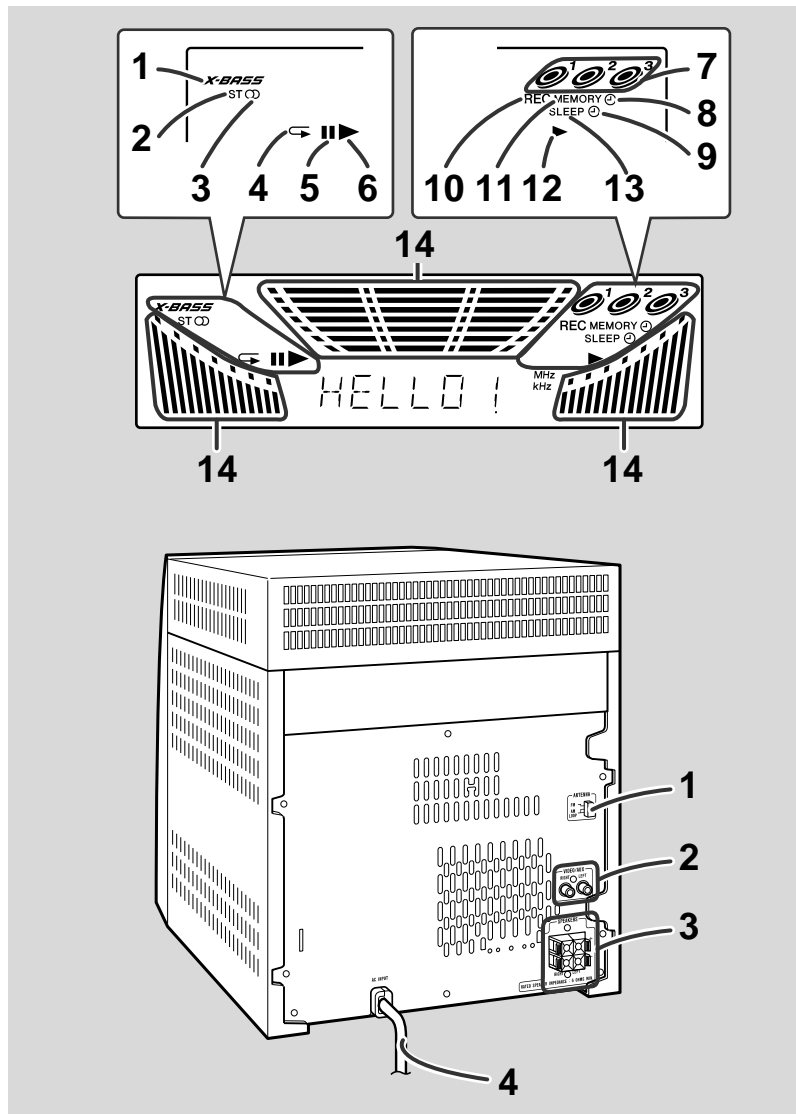

■ Display

1. Extra Bass Indicator
2. FM Stereo Mode Indicator
3. FM Stereo Receiving Indicator
4. CD Repeat Play Indicator
5. CD Pause Indicator
6. CD Play Indicator
7. Disc Number Indicators
8. Timer Play Indicator
9. Timer Recording Indicator
10. Tape 2 Record Indicator
11. Memory Indicator
12. Tape Play Indicator
13. Sleep Indicator
14. Spectrum Analyzer/Volume Level Indicator

■ Rear panel

- | | Reference page |
|---|----------------|
| 1. FM/AM Loop Antenna Jack | 10, 11 |
| 2. Video/Auxiliary (Audio Signal) Input Jacks | 28 |
| 3. Speaker Terminals | 10, 11 |
| 4. AC Power Cord | 10, 11 |

Controls and Indicators (continued)

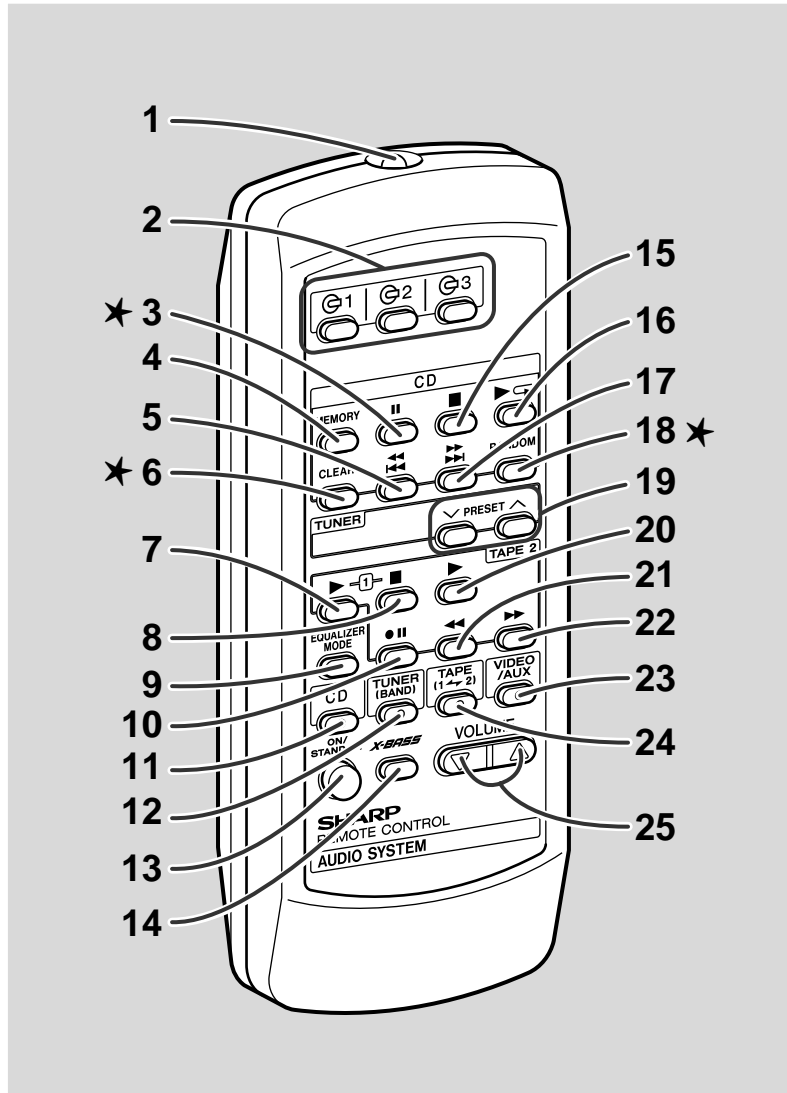

■ Remote control

	Reference page
1. Remote Control Transmitter	12
2. Disc Number Select Buttons	16, 19, 24
3. CD Pause Button	17
4. CD Memory Button	19
5. CD Track Down or Fast Reverse Button	17
6. CD Clear Button	19
7. Tape 1 Play Button	22
8. Tape 1/Tape 2 Stop Button	22, 23, 25
9. Equalizer Mode Select Button	14
10. Tape 2 Record Pause Button	23, 24, 25
11. CD Button	16, 24
12. Tuner (Band) Button	20
13. Power On/Stand-by Button	12, 26, 30
14. Extra Bass Button	14
15. CD Stop Button	17, 24
16. CD Play or Repeat Button	17, 18
17. CD Track Up or Fast Forward Button	17
18. CD Random Button	18
19. Tuner Preset Up/Down Buttons	21
20. Tape 2 Play Button	22
21. Tape 2 Rewind Button	22
22. Tape 2 Fast Forward Button	22
23. Video/Auxiliary Button	28
24. Tape (1 ~ 2) Button	22, 25
25. Volume Up or Down Buttons	14

Buttons with "*" mark in the illustration can be operated on the remote control only.
Other buttons can be operated both on the main unit and the remote control.

■ Speaker system

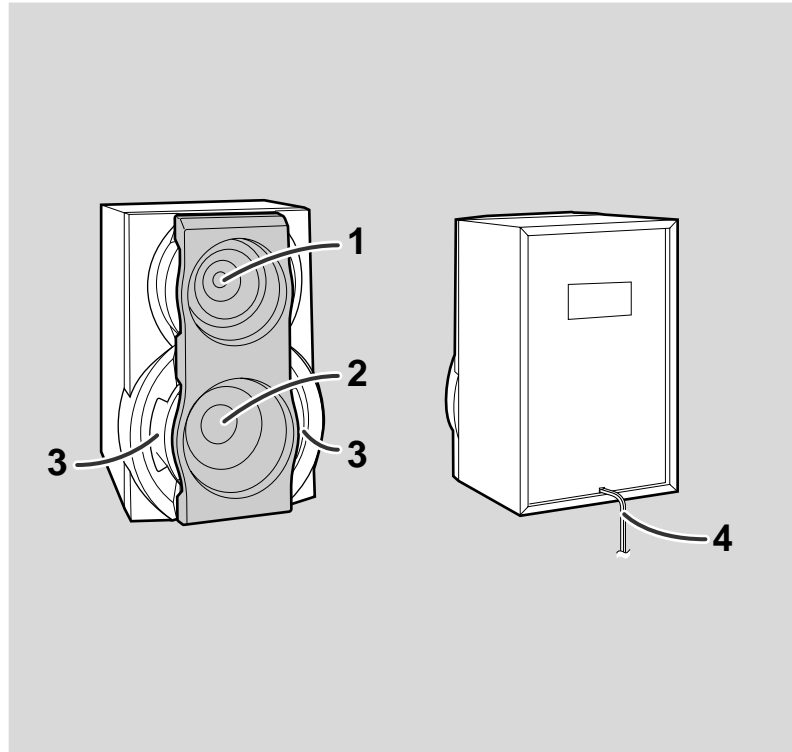

- 1. Tweeter
- 2. Woofer
- 3. Bass Reflex Duct
- 4. Speaker Wire

Speaker grilles are removable:

Make sure nothing comes into contact with the speaker diaphragms when you remove the speaker grilles.

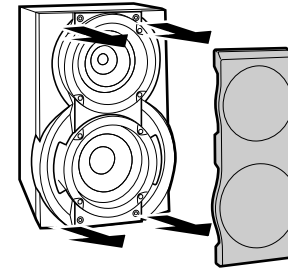

Placing the speaker system:

There is no distinction between the right and the left speakers.

Left speaker

Right speaker

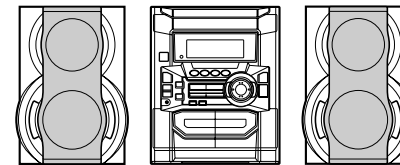

System Connections

Preparation for Use
- System Connections -

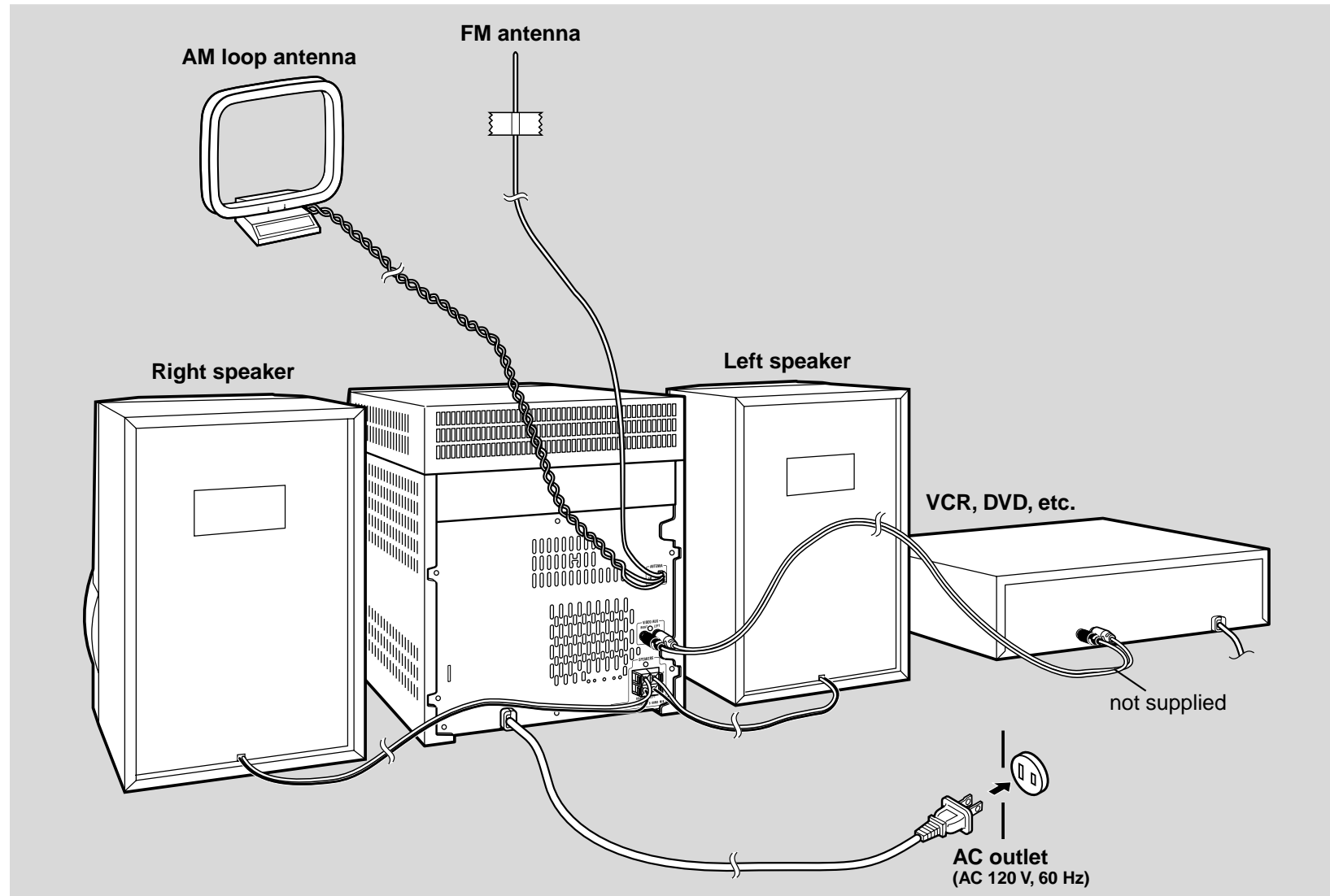

■ Speaker connection

Connect the black wire to the minus (-) terminal, and the red wire to the plus (+) terminal.

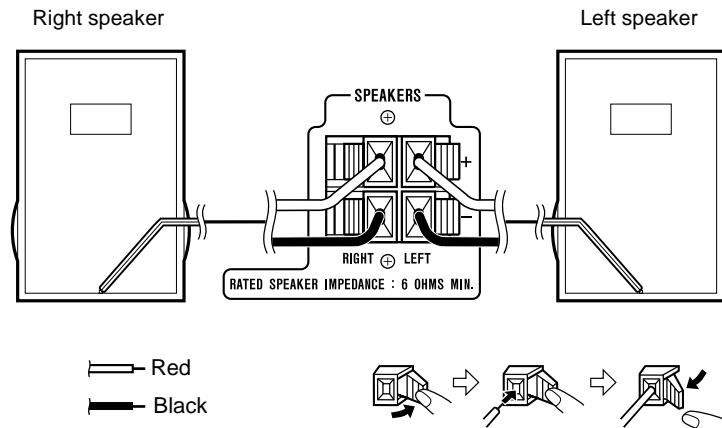

Caution:

- Use speakers with an impedance of 6 ohms or more, as lower impedance speakers can damage the unit.
- Do not mistake the right and the left channels. The right speaker is the one on the right side when you face the unit.
- **Do not let the bare speaker wires touch each other.**
- Do not allow any objects to fall into or to be placed in the bass reflex ducts.
- Do not stand or sit on the speakers. You may be injured.

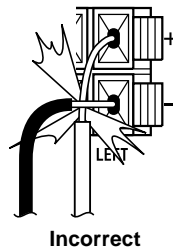

■ FM/AM loop antenna connection

Connect the FM/AM loop antenna to the ANTENNA jack.

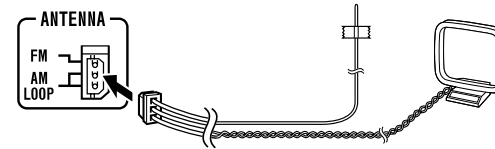

Position the FM antenna wire and rotate the AM loop antenna for optimum reception. Place the AM loop antenna on a shelf, or attach it to a stand or a wall.

Notes:

- Placing the antenna on the unit or near the AC power cord may cause noise pickup. Place the antenna away from the unit for better reception.
- Do not connect the attached FM antenna to an external FM antenna. Otherwise, trouble may occur.

Installing the AM loop antenna:

< Assembling >

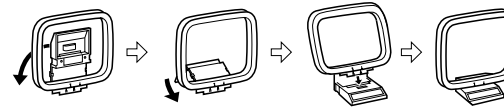

< Attaching to the wall >

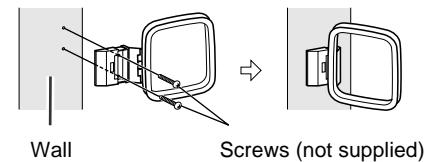

■ Connecting the AC power cord

After checking all the connections have been made correctly, plug the AC power cord of this unit into the AC outlet. If you plug the unit first, the unit will enter the demonstration mode (see page 13).

Note:

Unplug the unit if it will not be used for a prolonged period of time.

■ Demonstration mode (See page 13.)

Remote Control

■ Battery installation

Use 2 "AA" size batteries (UM/SUM-3, R6, HP-7 or similar).
Batteries are not included.

- 1 **Remove the battery cover.**
- 2 **Insert the batteries according to the direction indicated in the battery compartment.**
When inserting or removing the batteries, push them toward the ⊖ battery terminals.
- 3 **Replace the cover.**

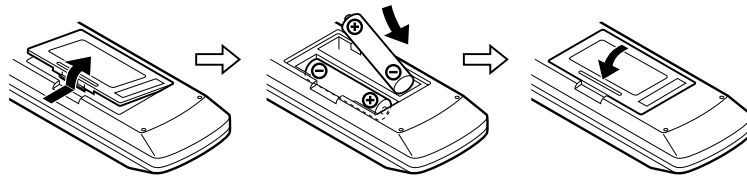

Precautions for battery use:

- Replace all old batteries with new ones at the same time.
- Do not mix old and new batteries.
- Remove the batteries if the unit will not be used for long periods of time. This will prevent potential damage due to battery leakage.

Caution:

- Do not use rechargeable batteries (nickel-cadmium battery, etc.).
- Installing the batteries incorrectly may cause the unit to malfunction.

Notes concerning use:

- Replace the batteries if the operating distance is reduced or if the operation becomes erratic.
- Periodically clean the transmitter on the remote control and the sensor on the unit with a soft cloth.
- Exposing the sensor on the unit to strong light may interfere with operation. Change the lighting or the direction of the unit.
- Keep the remote control away from moisture, heat, shock, and vibrations.

■ Test of the remote control

Face the remote control directly to the remote sensor on the unit.

The remote control can be used within the range shown below:

Press the ON/STAND-BY button. Does the power turn on? Now, you can enjoy the music.

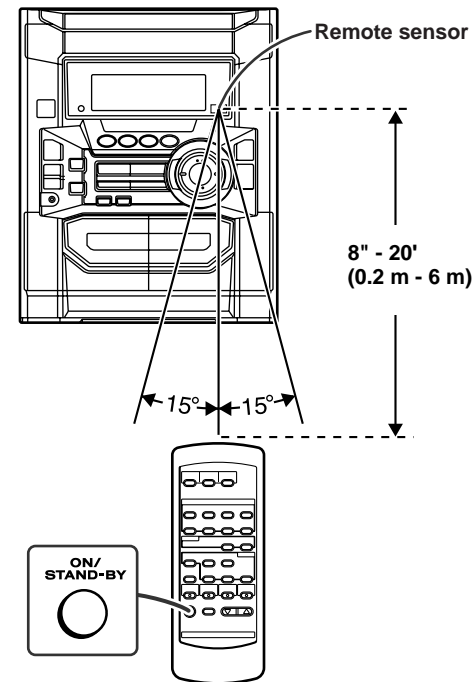

General Control

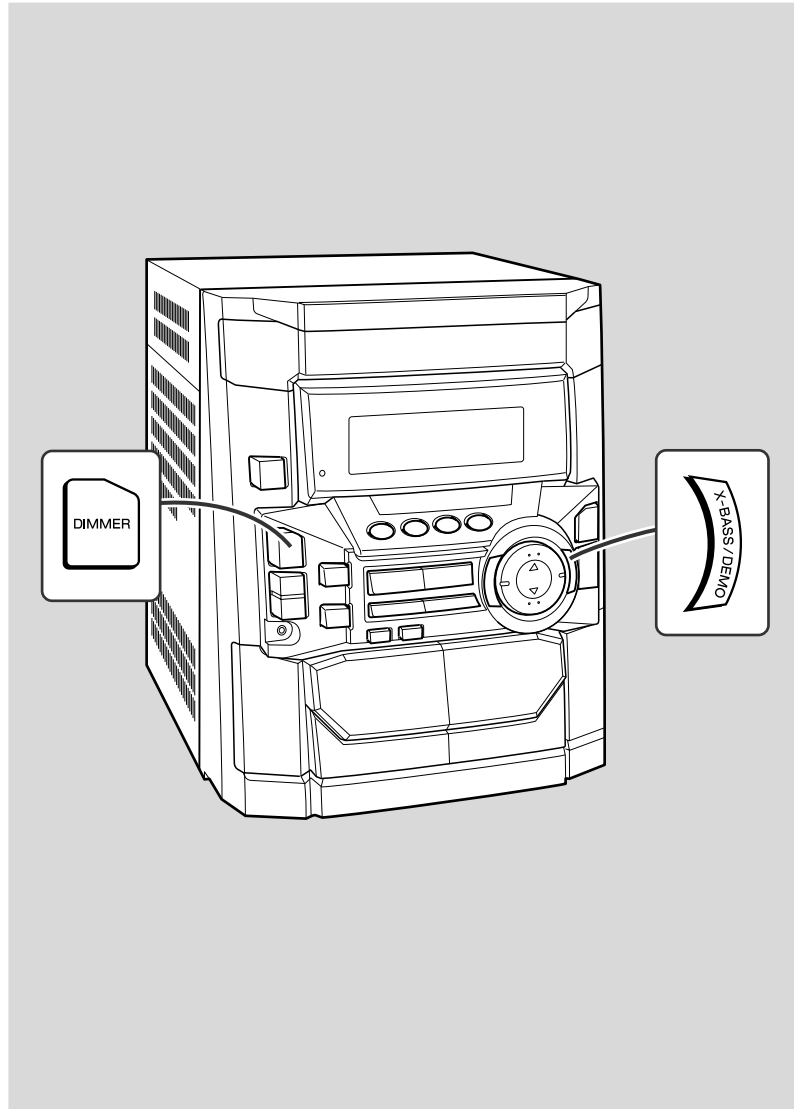

■ Demonstration mode

The first time the unit is plugged, the unit will enter the demonstration mode. You will see words scroll.



To cancel the demonstration mode:

When the unit is in the power stand-by mode (demonstration mode), press the X-BASS/DEMO button. The demonstration mode will be canceled and the display will disappear.

To return to the demonstration mode:

When the unit is in the power stand-by mode, press the X-BASS/DEMO button again.

Note:

When the power is on, the X-BASS/DEMO button can be used to select the extra bass mode.

■ Display brightness (2 levels)

You can switch the display brightness by pressing the DIMMER button.

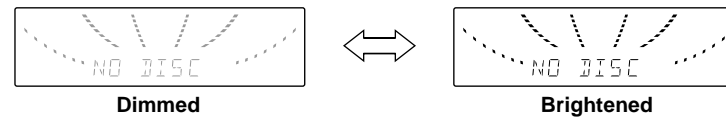

Sound Control

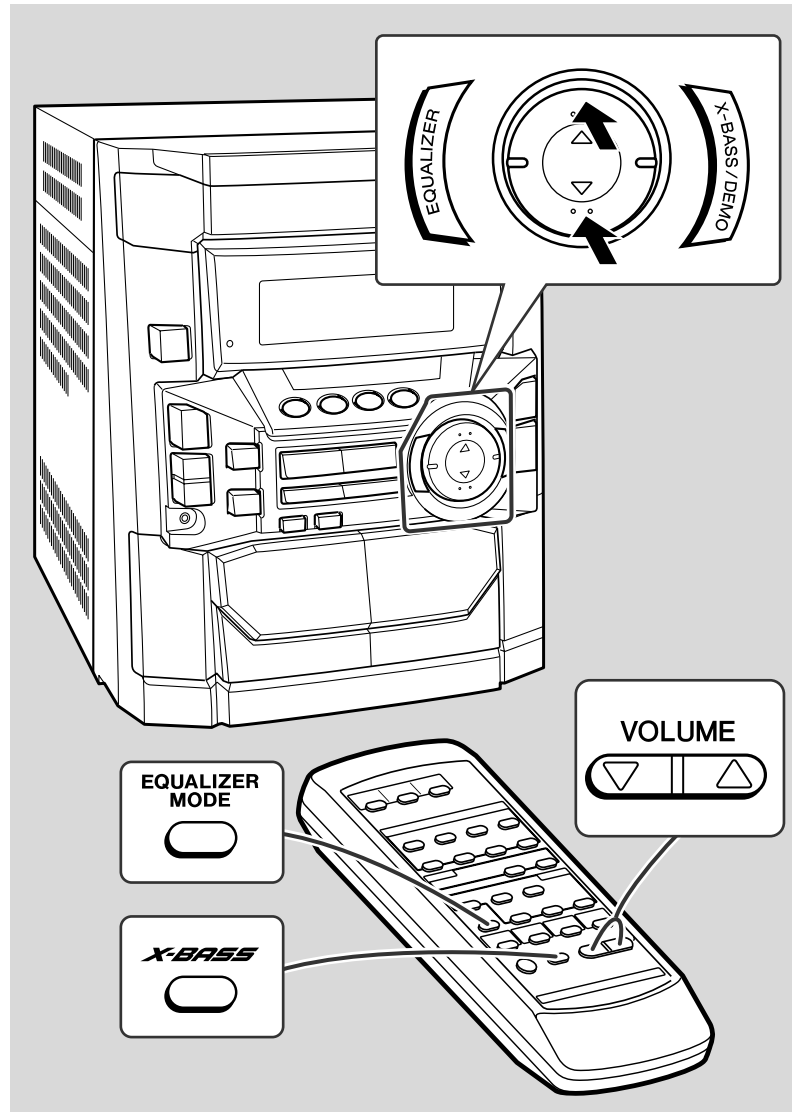

■ Volume control

Press the VOLUME Δ button to increase the volume and the VOLUME ∇ button for decreasing.



■ Bass control

When the power is first turned on, the unit will enter the extra bass mode which emphasizes the bass frequencies, and "X-BASS" will appear. To cancel the extra bass mode, press the X-BASS/DEMO (X-BASS) button.

X-BASS indicator

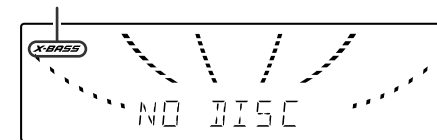

■ Equalizer

When the EQUALIZER (EQUALIZER MODE) button is pressed, the current mode setting will be displayed. To change to a different mode, press the EQUALIZER (EQUALIZER MODE) button repeatedly until the desired sound mode appears.

FLAT	The sound is not modified.
ROCK	Bass and treble are emphasized.
POPS	Bass and treble are slightly emphasized.
JAZZ	Treble is cut a little.
CLASSIC	Treble is reduced a lot.
VOCAL	Vocals (midrange tones) are emphasized.

Setting the Clock

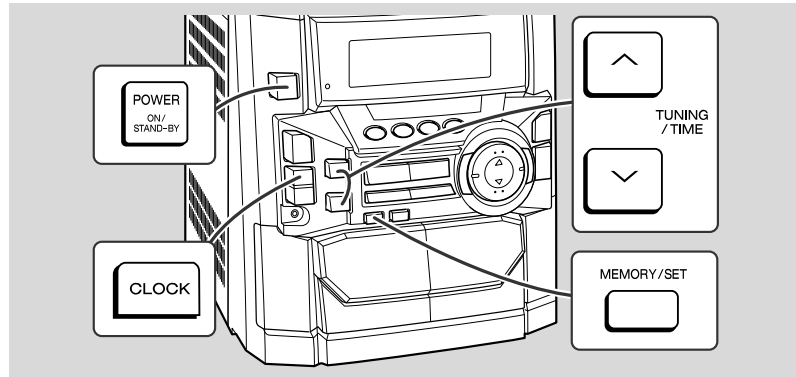

In this example, the clock is set for the 12-hour (AM 12:00) display.

1 Press the ON/STAND-BY button to turn the power on.

2 Press the CLOCK button and within 5 seconds, press the MEMORY/SET button.

3 Press the TUNING/TIME (∨ or ∧) button to select 12-hour or 24-hour display and then press the MEMORY/SET button.

"AM 12:00" → The 12-hour display will appear.
(AM 12:00 - PM 11:59)

"AM 0:00" → The 12-hour display will appear.
(AM 0:00 - PM 11:59)

"0:00" → The 24-hour display will appear.
(0:00 - 23:59)

Note that this can only be set when the unit is first installed or it has been reset.
(Refer to step 3 under "If trouble occurs" on page 30.)

4 Press the TUNING/TIME (∨ or ∧) button to adjust the hour and then press the MEMORY/SET button.

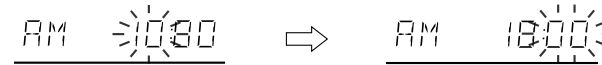

- Press the TUNING/TIME (∨ or ∧) button once to advance the time by 1 hour. Hold it down to advance continuously.
- When the 12-hour display is selected, "AM" will change automatically to "PM".

5 Press the TUNING/TIME (∨ or ∧) button to adjust the minutes and then press the MEMORY/SET button.

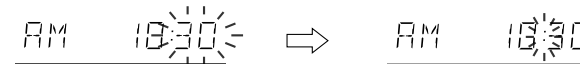

- Press the TUNING/TIME (∨ or ∧) button once to advance the time by 1 minute. Hold it down to change the time in 5-minute intervals.
- The hour will not advance even if minutes advance from "59" to "00".
- The clock begins counting from "0" seconds. (Seconds are not displayed.) The time display will disappear after a few seconds.

To confirm the time display:

Press the CLOCK button.

The time display will appear for about 5 seconds.



Note:

The "CLOCK" or time will flash at the push of the CLOCK button when the AC power supply is restored after a power failure or unplugging the unit. Readjust the clock as follows.

To readjust the clock:

Perform "Setting the Clock" from the beginning. If the time display is flashing, step 3 (for selecting the 12-hour or 24-hour display) will be skipped.

To change the 12-hour or 24-hour display:

- 1 Clear all the programmed contents. [Perform to step 3 under "If trouble occurs" on page 30 for details.]
- 2 Perform "Setting the Clock" from the beginning.

Listening to a CD (CDs)

This system can play audio CD-R and CD-RW discs just as CD discs, but cannot perform recording.

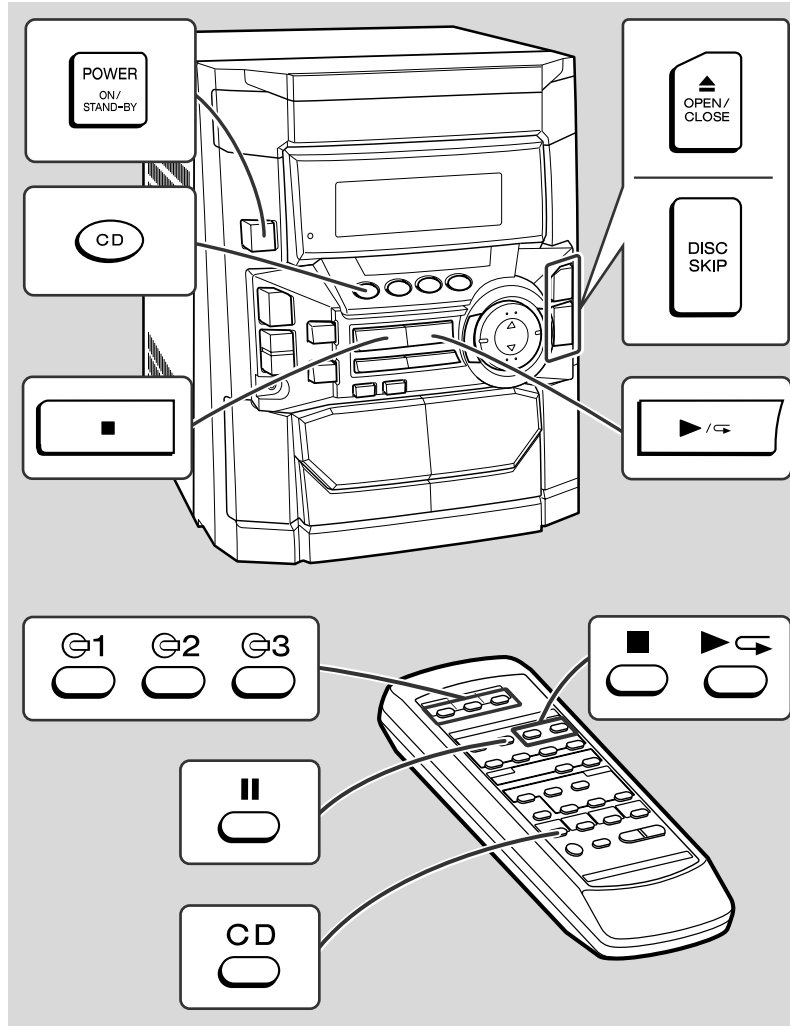

- 1** Press the ON/STAND-BY button to turn the power on.
 - 2** Press the CD button.
 - 3** Press the \blacktriangle OPEN/CLOSE button to open the disc tray.
 - 4** Place the CD(s) on the disc tray, label side up.
 When loading a third disc, press the DISC SKIP button to turn the disc tray, then place the CD in the open position.
 - CDs can be placed on any open position on the disc tray.
 - Be sure to place 3" (8 cm) CD(s) in the middle of the disc positions.
-
- 5** Press the \blacktriangle OPEN/CLOSE button to close the disc tray.
-
- 6** To select the CD you want to listen to first, press one of $\odot 1$ - $\odot 3$ buttons on the remote control.

7 Press the ►/◄ (► ◄) button to start playback.



- Playback will begin from track 1 on the disc you have selected to play. After that disc finishes playing, the next disc will automatically start playback.
- When the last track on the third disc has finished playing, the CD player will stop automatically.
- When there is no CD in one of the disc 1 - 3 positions, that position will be skipped and the next CD will be played.

To interrupt playback:

Press the CD button on the remote control.
To resume playback from the same point, press the ► ◄ button.

To stop playback:

Press the (CD button).

To remove the CDs:

While in the stop mode, press the OPEN/CLOSE button.
The disc tray will open. Remove the two discs. Then, press the DISC SKIP button to rotate the disc tray and remove the remaining disc.

After use:

Press the ON/STAND-BY button to enter the power stand-by mode.

Caution:

- Do not place two CDs in one disc tray.
- Do not push the disc tray while it is moving.
- Do not turn the disc tray by hand. This may cause malfunctions.
- If the power fails while the tray is open, wait until the power is restored.
- If the disc tray is stopped forcibly, "ER-CD10" will appear in the display and the unit will not function. If this occurs, press the ON/STAND-BY button to enter the power stand-by mode and then turn the power on again.
- If TV or radio interference occurs during CD operation, move the unit away from the TV or radio.
- If a disc is damaged, dirty, or loaded upside down, the disc will be skipped.

■ To locate the beginning of a track

To move to the beginning of the next track:

Press the PRESET button for less than 0.5 seconds during playback.



- You can skip to any track by pressing the PRESET button repeatedly until the desired track number appears.

To restart the track being played:

Press the PRESET button for less than 0.5 seconds during playback.



- You can skip to any track by pressing the PRESET button repeatedly until the desired track number appears.

Notes:

- You can locate the beginning of a track on a single disc only.
- The / or / button on the remote control allows you to locate the beginning of a track.

■ To locate the desired portion

For audible fast forward:

Press and hold down the PRESET button during playback.



For audible fast reverse:

Press and hold down the PRESET button during playback.



Notes:

- Normal playback will resume when the PRESET or PRESET button is released.
- You can locate the desired portion on a single disc only.
- When the end of the last track is reached during fast forward, "END" will appear on the display and CD operation will be paused. When the beginning of the first track is reached during fast reverse, the disc will start playback automatically.
- The / or / button on the remote control allows you to locate the desired portion.

Starting playback with a desired track

You can play a disc starting with the desired track.

- 1 While in the stop mode, press one of the 1 - 3 buttons on the remote control or DISC SKIP button to select the desired disc.

Selected disc number

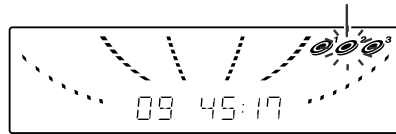

- 2 Press the PRESET ∇ or \wedge PRESET \triangleright button to select the desired track.

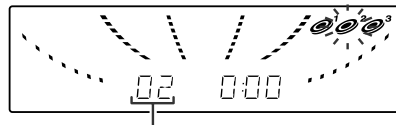

Selected track number

You can also select a track by pressing the \ll / \ll or \gg / \gg button on the remote control.

- 3 Press the \triangleright / \square (\triangleright \square) button to start playback.

Playback of the selected track is started. When the end of last track of the disc with the selected track is reached, the next disc will be automatically started.

To stop playback:

Press the \blacksquare (CD \blacksquare) button.

Notes:

- When the DISC SKIP button is pressed during playback, the next disc will begin automatically.
- When one of the 1 - 3 buttons on the remote control is pressed during playback, the selected disc will begin automatically.

Repeat or Random Play

Repeat Play

All tracks on up to 3 discs, or a programmed sequence can be continuously repeated.

To repeat all tracks on up to 3 discs:

Press the \triangleright / \square (\triangleright \square) button twice.

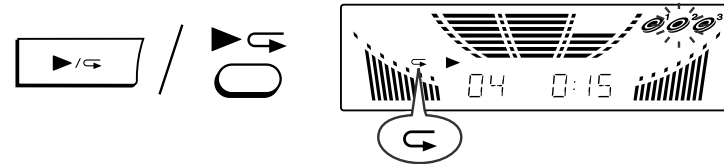

To repeat a desired track:

Perform steps 1 - 4 in the "Programmed Play" section and then press the \triangleright / \square (\triangleright \square) button twice.

To cancel repeat play:

Press the \triangleright / \square (\triangleright \square) button again.
" \square " will go out.

Random Play

The tracks on the disc(s) can be played in random order automatically.

Press the RANDOM button on the remote control to begin random play.

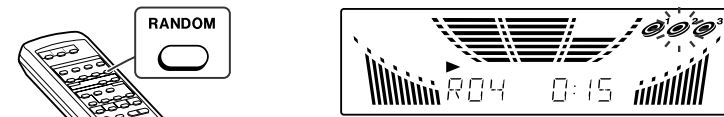

To cancel random play:

Press the \triangleright \square button.

Notes:

- If you press the \gg / \gg button during random play, you can move to the track selected next by the random operation. On the other hand, the \ll / \ll button does not allow you to move to the previous track. The beginning of the track being played will be located.
- In random play, the CD player will select and play tracks automatically. (You cannot select the order of the tracks.)

Caution:

After performing repeat or random play, be sure to press the \blacksquare (CD \blacksquare) button. Otherwise, the disc(s) will play continuously.

Programmed Play

By specifying discs from 1 to 3 and tracks from 1 to 99, you can choose up to 32 selections for playback in the order you like.

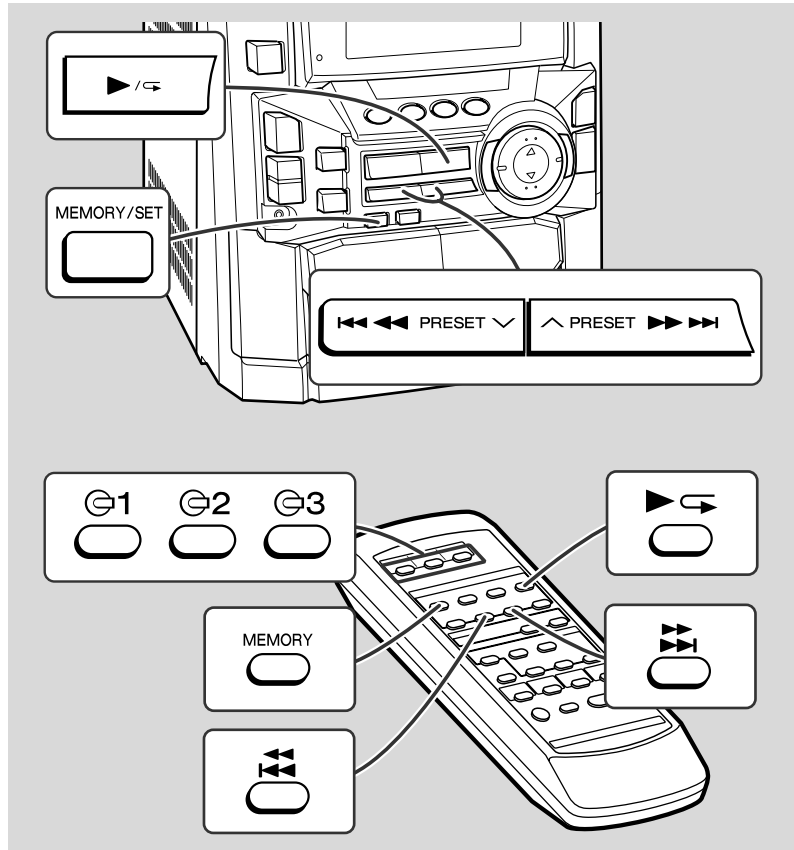

1 While in the stop mode, press one of the 1 - 3 buttons on the remote control to select the desired disc.

Selected disc number

2 Press the PRESET (left) or PRESET (right) button to select the desired track.

Selected track number

You can also select a track by pressing the <</> or >>/>> button on the remote control.

3 Press the MEMORY/SET (MEMORY) button to save the track number.

Playback order

When the track is memorized, "MEMORY" will appear.

4 Repeat steps 1 - 3 for other tracks. Up to 32 tracks can be programmed.

If you make a mistake, the programmed tracks can be cleared by pressing the CLEAR button.

5 Press the play/pause button to start playback.

To clear the programmed selections:
While in the stop mode, press the CLEAR button on the remote control. Each time the button is pressed, one track will be cleared, beginning with the last track programmed. When all the tracks are cleared, "MEMORY" will disappear.

Adding tracks to the program:
If a program has been previously stored, the "MEMORY" indicator will be displayed. Then follow steps 1 - 3 to add tracks. The new tracks will be stored after the last track of the original program.

- Notes:**
- Opening the disc tray automatically cancels the programmed sequence.
 - Even if you press the ON/STAND-BY button to enter the stand-by mode or change the function from CD to another, the programmed selections will not be cleared.
 - During program operation, random play is not possible.

Listening to the Radio

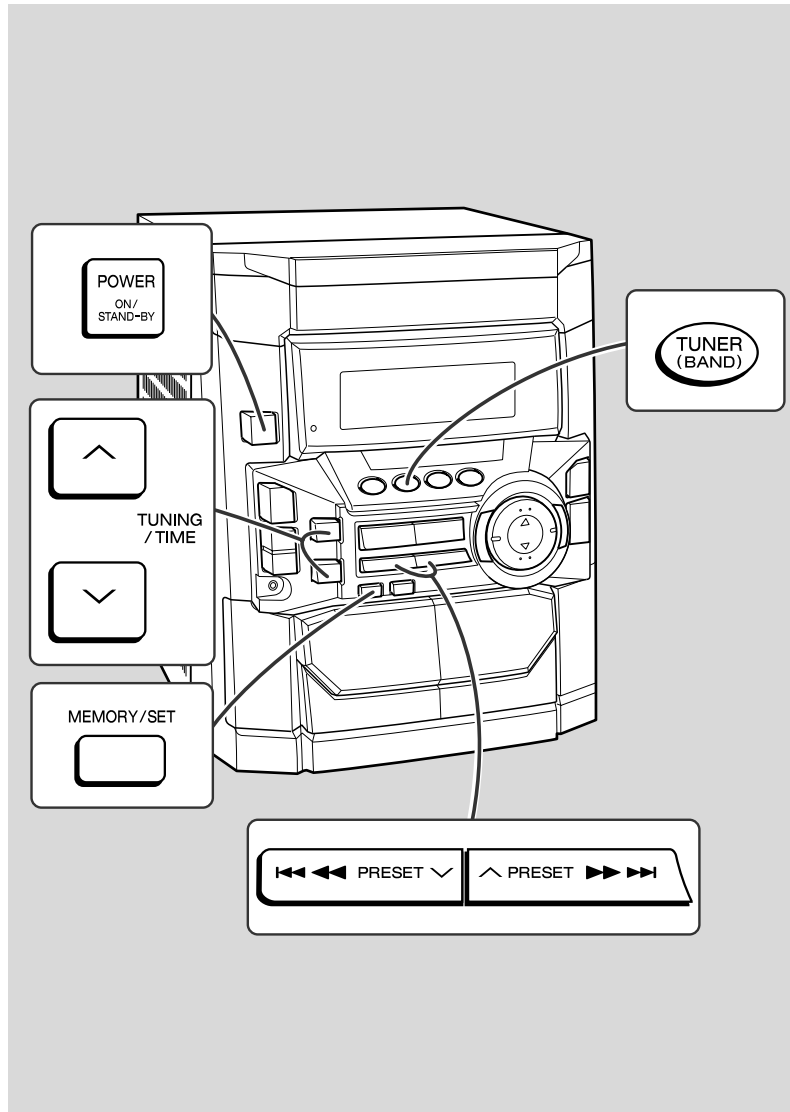

- 1** Press the ON/STAND-BY button to turn the power on.
- 2** Press the TUNER (BAND) button repeatedly to select the desired frequency band (FM or AM).
- 3** Press the TUNING/TIME (∨ or ∧) button to tune in to the desired station.
 - Manual tuning:**
Press the TUNING/TIME button as many times as required to tune in to the desired station.
 - Auto tuning:**
When the TUNING/TIME button is pressed for more than 0.5 seconds, scanning will start automatically and the tuner will stop at the first receivable broadcast station.
 - Notes:**
 - When radio interference occurs, auto scan tuning may stop automatically at that point.
 - Auto scan tuning will skip weak signal stations.
 - To stop the auto tuning, press the TUNING/TIME button again.

To receive an FM stereo transmission:

- Press the TUNER (BAND) button to display the "ST" indicator.
- "∞" will appear when an FM broadcast is in stereo.

FM stereo mode indicator

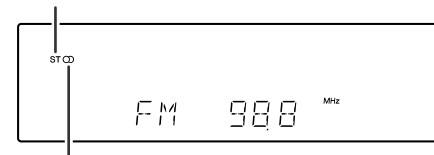

FM stereo receiving indicator

- If the FM reception is weak, press the TUNER (BAND) button to extinguish the "ST" indicator. The reception changes to monaural, and the sound becomes clearer.

After use:

Press the ON/STAND-BY button to enter the power stand-by mode.

Listening to the memorized station

■ Memorizing a station

You can store 40 AM and FM stations in memory and recall them at the push of a button. (Preset tuning)

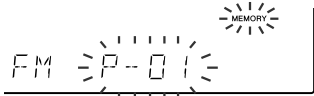
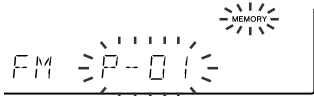
- 1 Perform the steps 1 - 3 in "Listening to the Radio" on page 20.**
- 2 Press the MEMORY/SET button to enter the preset tuning saving mode.**

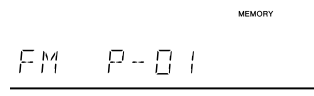
- 3 Within 30 seconds, press the PRESET button to select the preset channel number.**

Store the stations in memory, in order, starting with preset channel 1.
- 4 Within 30 seconds, press the MEMORY/SET button to store that station in memory.**

If the "MEMORY" and preset number indicators go out before the station is memorized, repeat the operation from step 2.
- 5 Repeat steps 1 - 4 to set other stations, or to change a preset station.**

When a new station is stored in memory, the station previously memorized will be erased.

Note:

The backup function protects the memorized stations for a few hours should there be a power failure or the AC power cord disconnection.

■ To recall a memorized station

Press the PRESET button for less than 0.5 seconds to select the desired station.

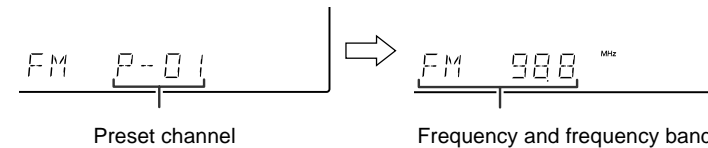

This can be operated by pressing the PRESET (∨ or ∧) button on the remote control.

■ To scan the preset stations

The stations saved in memory can be scanned automatically. (Preset memory scan)

- 1 Press the PRESET button for more than 0.5 seconds.**
 - The preset number will flash and the programmed stations will be tuned in sequentially, for 5 seconds each.
 - This can be operated by pressing the PRESET (∨ or ∧) button on the remote control.
- 2 Press the PRESET button again when the desired station is located.**

■ To erase entire preset memory

- 1 Press the ON/STAND-BY button to enter the stand-by mode.
- 2 Press the ON/STAND-BY button while holding down the TUNER (BAND) button and X-BASS/DEMO button until "TUNER CL" appears.



Listening to a Cassette Tape (TAPE 1 or TAPE 2)

Before playback:

- For playback, use normal or low-noise tapes for the best sound. (Metal or CrO₂ tapes are not recommended.)
- Do not use C-120 tapes or poor-quality tapes, as they may cause malfunctions.
- Before loading a tape into the cassette compartment, tighten the slack with a pen or a pencil.

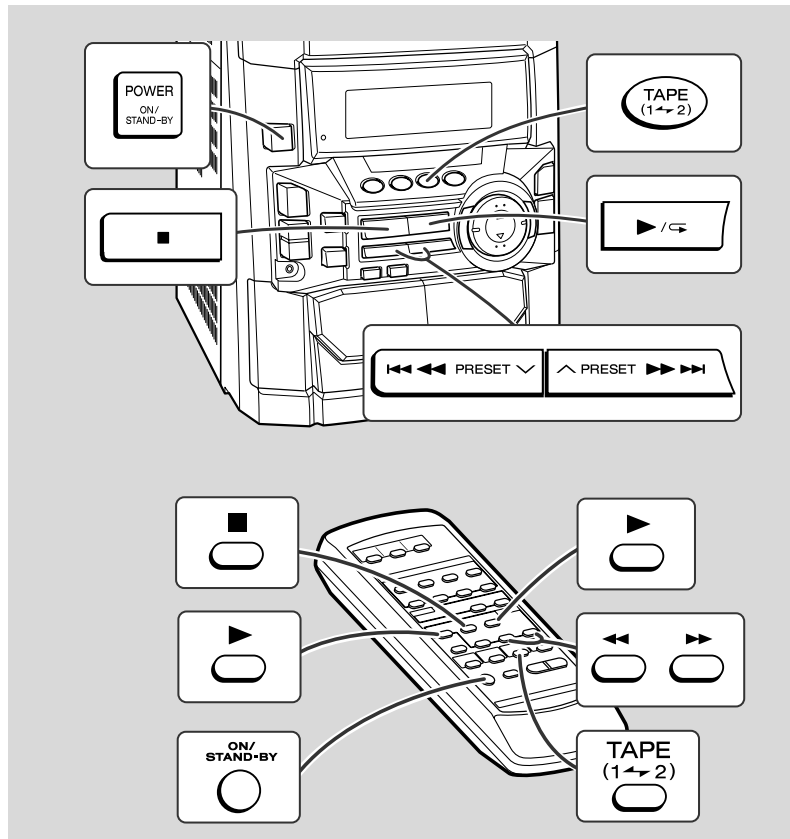
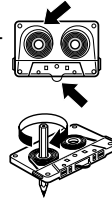

Playback is possible in TAPE 1 compartment as well as in TAPE 2.

- 1 Press the ON/STAND-BY button to turn the power on.**
- 2 Open the cassette door by pushing the area marked "▲ PUSH EJECT".**
- 3 Load a cassette into the TAPE 1 or TAPE 2 cassette compartment with the side to be played facing toward you.**
- 4 Press the TAPE (1 ~ 2) button to select the cassette you want to listen to.**
- 5 Press the ▶ / = button to start playback.**

When playback is performed using the remote control, press the TAPE 1 or TAPE 2 ▶ button.

To stop playback:

Press the ■ (TAPE ■) button.

Fast forward/rewind: (TAPE 2 only)

- 1 Press the ■ (TAPE ■) button, then press the TAPE (1 ~ 2) button to select TAPE 2.
- 2 To advance the tape, press the ^ PRESET ▶▶▶▶ (TAPE 2 ▶▶) button. To rewind it, press the ◀◀◀◀ PRESET ∨ (TAPE 2 ◀◀) button.

Caution:

- To remove the cassette, press the ■ (TAPE ■) button, and then open the compartment.
- Before changing from one tape operation to another, press the ■ (TAPE ■) button.
- If a power failure occurs during tape operation, the tape head will remain engaged with the tape and the cassette door will not open. In this case, wait until the power is restored.

Recording from the Radio

Before recording:

- When recording important selections, make a preliminary test to ensure that the desired material is properly recorded.
- SHARP is not liable for damage or loss of your recording arising from malfunction of this unit.
- The volume and sound controls can be adjusted with no effect on the recorded signal (Variable Sound Monitor).
- **For recording, use only normal tapes. Do not use metal or CrO₂ tapes.**

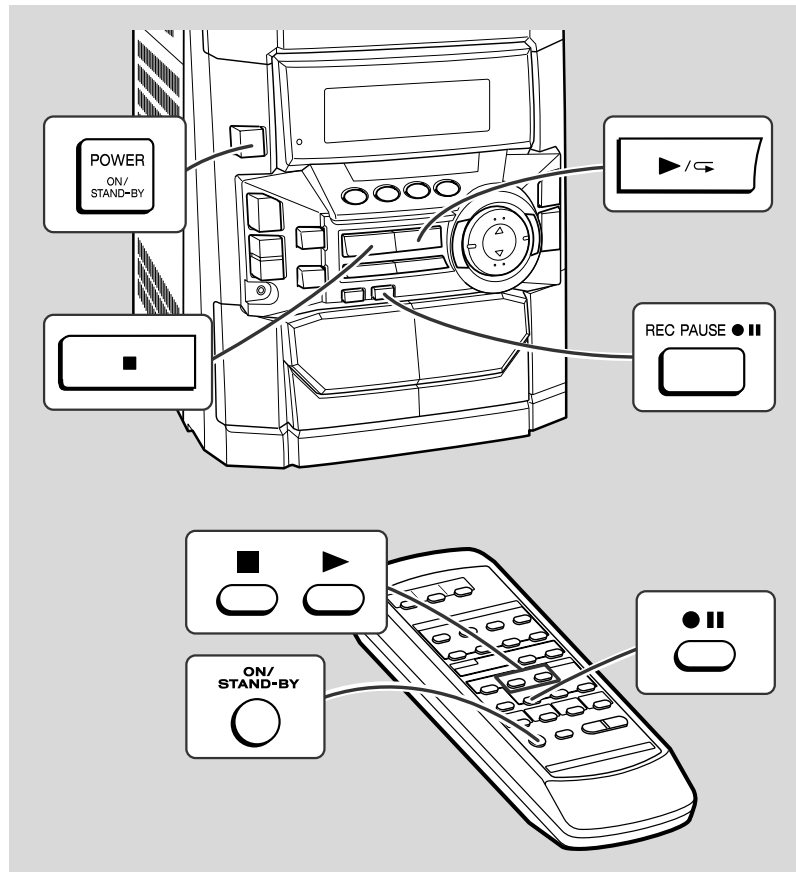

Recording can be operated in the TAPE 2 compartment. The TAPE 1 is for playback only.

1 Tune in to the desired station. (See page 20.)

2 Load a cassette into the TAPE 2 cassette compartment with the side to be recorded on facing you.

Wind past the leader of the tape, on which recording cannot be performed.

3 Press the REC PAUSE ●|| (●||) button.

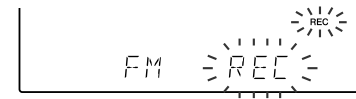

Recording will be paused.

4 Press the ▶/◀ button on the main unit or the TAPE 2 ▶ button on the remote control to start recording.

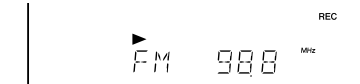

To interrupt recording:

Press the REC PAUSE ●|| (●||) button.

To resume recording, press the ▶/◀ (TAPE 2 ▶) button.

To stop recording:

Press the ■ (TAPED ■) button.

Note:

If you hear a whistling noise while recording an AM station, move the AM loop antenna.

Erase-prevention tab of cassette tapes:

- When recording on a cassette tape, make sure that the erase-prevention tabs are not removed. Cassettes have removable tabs that prevent accidental recording or erasing.
- To protect the recorded sound, remove the tab after recording. Cover the tab hole with adhesive tape to record on the tape without the tab.

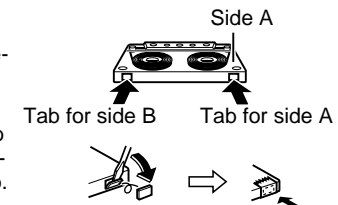

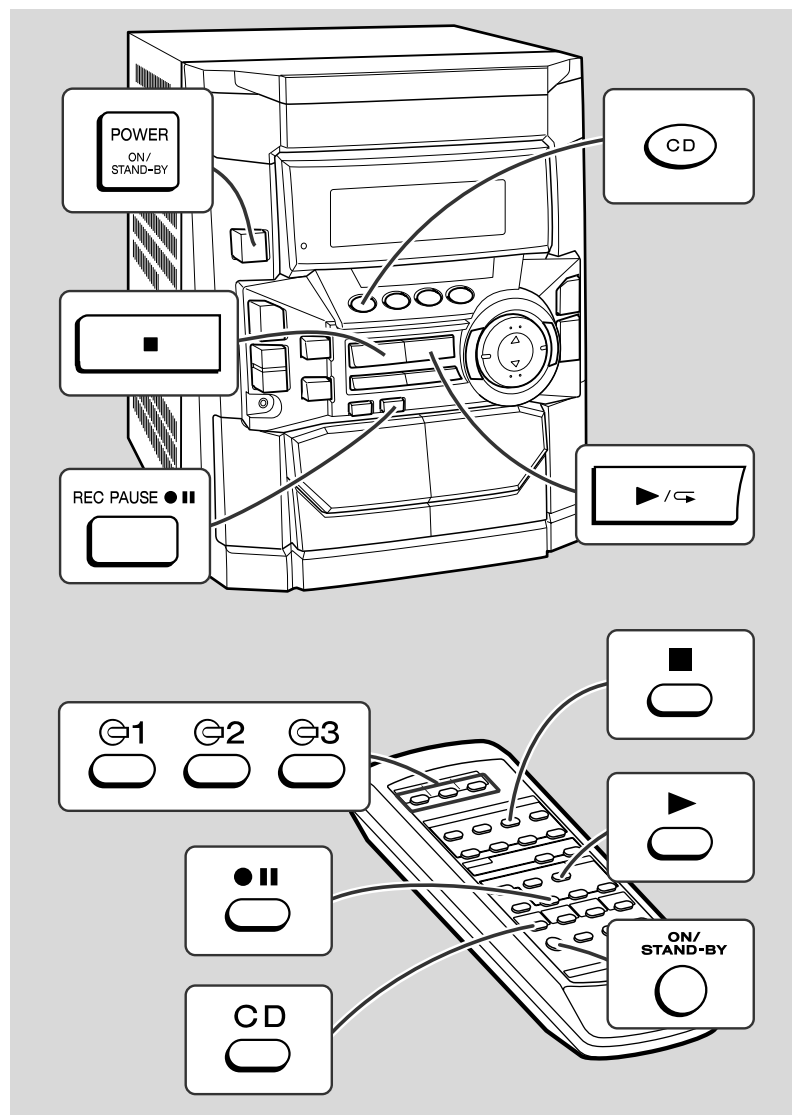

■ Listening to the Radio (See page 20.)

Recording from a CD (CDs)

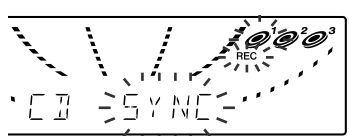

You can record 3 CDs continuously.

- 1 Press the ON/STAND-BY button to turn the power on.**
- 2 Load a cassette into the TAPE 2 cassette compartment with the side to be recorded on facing you.**
Wind past the leader of the tape, on which recording cannot be performed.
- 3 Press the CD button and load the desired disc.**
- 4 Press one of the G 1 - G 3 buttons on the remote control to select the disc to be recorded first.**
- 5 Press the REC PAUSE ●|| (●||) button.**

Recording will be paused.
- 6 Press the ▶/◀ (TAPE 2 ▶) button to start recording.**

 - CD playback will start approximately 5 seconds after the tape starts.
 - Recording is started from the selected CD. When the playback of the last disc is finished or the end of the tape is reached, the CD and the cassette will stop automatically.

To perform programmed recording:

- 1 Program discs and tracks. (See page 19.)
- 2 Press the REC PAUSE ●|| (●||) button.
- 3 Press the ▶/◀ (TAPE 2 ▶) button.

To stop recording:

Press the ■ (CD ■) button.
The CD and tape will stop.

Note:

When the end of the tape is reached while recording, the CD player will display the track number which was being played at that time, and stop automatically. If you want to restart recording from the beginning of the interrupted track, turn over the tape, press the REC PAUSE ●|| (●||) button and then the ▶/◀ (TAPE 2 ▶) button. (If tracks have been stored in memory by programming, recording will restart from the first track stored in memory.)

Dubbing from Tape to Tape

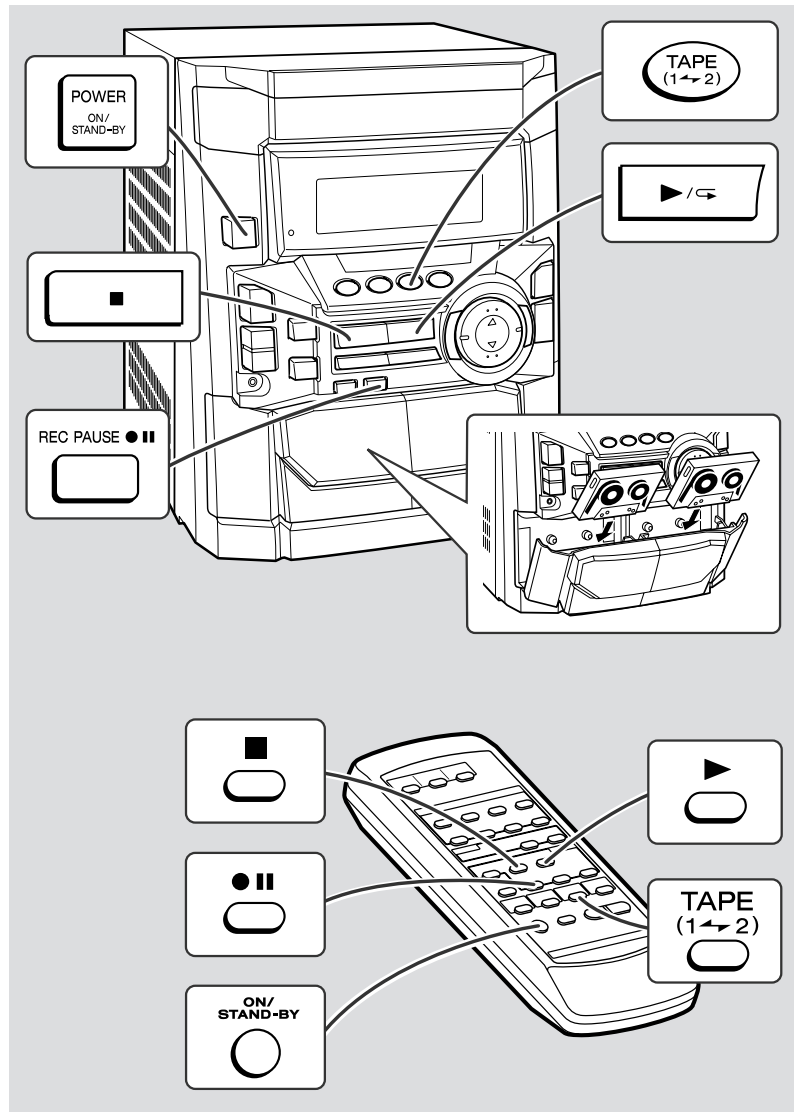

You can record from TAPE 1 to TAPE 2.
For recording, use only normal tapes. Do not use metal or CrO₂ tapes.

- 1 Press the ON/STAND-BY button to turn the power on.**
- 2 Load a prerecorded cassette into the TAPE 1 cassette compartment. Insert a blank tape into the TAPE 2 cassette compartment.**
It is recommended that the recording tape is the same length as the master tape.
- 3 Press the TAPE (1 → 2) button until "TAPE 1" appears on the display.**



- 4 Press the REC PAUSE button.**

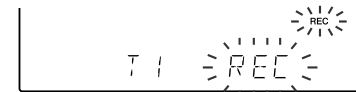

Recording will be paused.

- 5 Press the ▶ / ◀ button on the main unit or the TAPE 2 ▶ button on the remote control to start dubbing.**



To stop dubbing:

Press the ■ (TAPE ■) button.
TAPE 1 and TAPE 2 will simultaneously stop.

■ Erasing recorded tapes

- Load the tape to be erased into the TAPE 2 cassette compartment with the side to be erased facing toward you.
- Press the TAPE (1 → 2) button until "TAPE 2" appears on the display.
- Press the REC PAUSE button.
- Press the ▶ / ◀ button on the main unit or the TAPE 2 ▶ button on the remote control to start erasing.

Note:

Make sure that the TAPE 1 is not in use.

Timer and Sleep Operation

Timer playback:

The unit turns on and plays the desired source (CD, tuner, tape) at the preset time.

Timer recording:

The unit turns on and starts recording from the tuner at the preset time.

Sleep operation:

The radio, compact disc and cassette tape can all be turned off automatically.

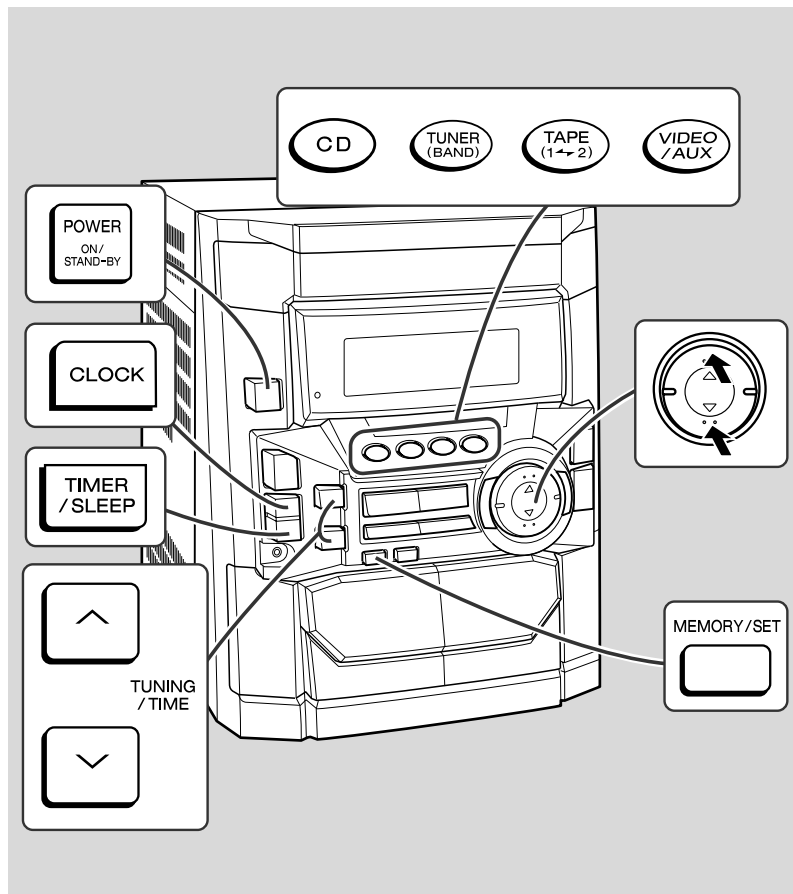

■ Timer playback or Timer recording

Before setting timer:

- 1 Press the CLOCK button to check that the clock is on time.



- 2 For timer playback: Load a cassette or discs to be played.
For timer recording: Load a cassette for recording in the TAPE 2 cassette compartment.



- 1 Press the ON/STAND-BY button to turn the power on.

- 2 Press the CD, TUNER (BAND) or TAPE (1 – 2) button to select the desired function.

To select the timer playback source: CD, TUNER (BAND) or TAPE (1 – 2).

To select the timer recording source: TUNER (BAND).

When you selected the TUNER (BAND), tune in to the desired station.

- 3 Adjust the volume using the VOLUME buttons.

Do not turn the volume up too high.

- 4 Press the TIMER/SLEEP button repeatedly to select timer playback or timer recording.

Display the white "☼" for timer playback and the red "☼" for timer recording.



- 5 Press the TUNING/TIME (∨ or ∧) button to specify the hour to start, then press the MEMORY/SET button.

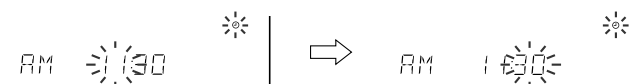

The illustrations show the timer playback setting.

- 6** Press the TUNING/TIME (∨ or ∧) button to specify the minute, then press the MEMORY/SET button.

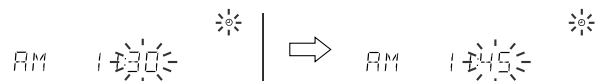

- 7** The unit will enter the timer stand-by mode automatically.

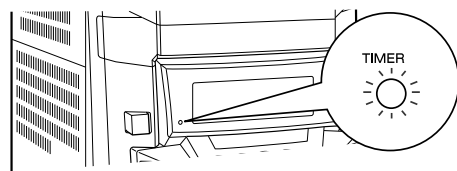

To cancel the timer playback/timer recording:
Press the ON/STAND-BY button to turn the power on.

- 8** When the preset time is reached, playback or recording will start.

The volume will increase gradually until it reaches the volume you were listening at before your system enters the timer stand-by mode.

- 9** In timer playback:

If you select CD or TAPE, the unit will enter the stand-by mode after the playback. If you select TUNER, it will enter the stand-by mode one hour after the timer playback starts.

In timer recording:

When the recording tape reaches its end, the timer recording will end, and the unit will enter the stand-by mode.

To reset or change the timer setting:

Perform "Timer playback or Timer recording" from the beginning.

Notes:

- Once the time is set, the setting will be retained until a new time is entered.
- When performing timer playback or recording using another unit connected to the VIDEO/AUX jacks, select "VIDEO/AUX" in step 2. At this time, only this unit will be turned on or enter the power stand-by mode automatically. It will enter the power stand-by mode when the end of the recording tape is reached in timer recording or 1 hour after the playback starts in timer playback. However, another unit will not be turned on or off.

■ Sleep operation

- 1** Play back the desired sound source.

- 2** Press the TIMER/SLEEP button repeatedly until "SLEEP" is displayed.

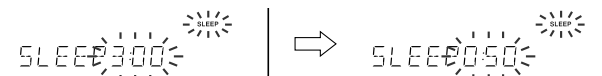

To change the sleep time:

While the sleep time is displayed, press the TUNING/TIME (∨ or ∧) button.

(Maximum: 3 hours - Minimum: 1 minute)

- 3 hours - 5 minutes → 5-minute intervals
- 5 minutes - 1 minute → 1-minute intervals

- 3** Press the MEMORY/SET button.

- 4** Your system will enter the power stand-by mode automatically after the preset time has elapsed.

The volume will be turned down 1 minute before the sleep operation finishes.

To cancel the sleep operation:

Press the ON/STAND-BY button while the sleep timer is set.

To confirm the remaining sleep time:

Press the TIMER/SLEEP button while the sleep timer is set. The remaining sleep time is displayed for about 5 seconds.

Note:

Once the sleep time is set, it will remain unchanged until the setting is changed.

Enhancing Your System

The connection cord is not included. Purchase a commercially available cord as shown below.

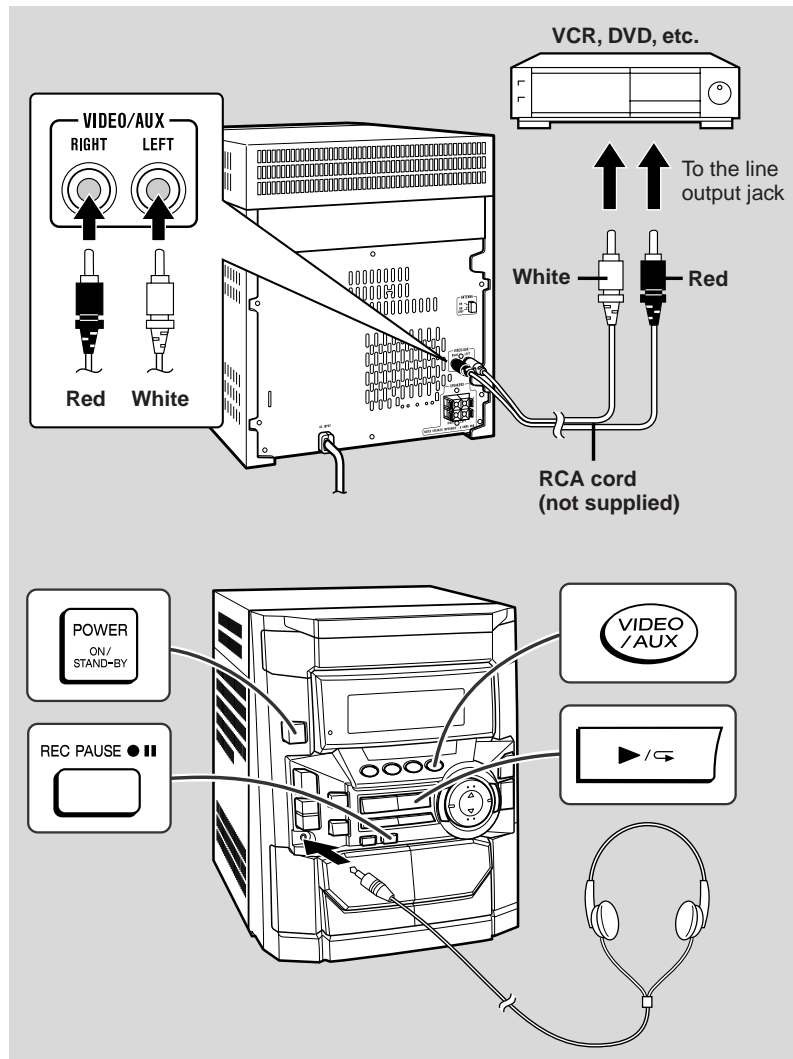

■ Listening to the playback sounds from VCR, DVD, etc.

- 1 Use a connection cord to connect the VCR, DVD, etc. to the VIDEO/AUX jacks.**
When using video equipment, connect the audio output to this unit and the video output to a television.
- 2 Press the ON/STAND-BY button to turn the power on.**
- 3 Press the VIDEO/AUX button.**
- 4 Play the connected equipment.**

Note:

To prevent hum interference, place this unit away from a television.

■ To record on a tape

- 1 Insert a cassette in the TAPE 2 cassette compartment.**
- 2 Press the VIDEO/AUX button.**
- 3 Press the REC PAUSE button.**
- 4 Press the play/pause button (TAPE 2 button).**
- 5 Play the VCR, DVD, etc.**

■ Headphones

- Before plugging in or unplugging the headphones, reduce the volume.
- Be sure your headphones have a 1/8" (3.5 mm) diameter plug and are between 16 ohms and 50 ohms impedance. The recommended impedance is 32 ohms.
- Plugging in the headphones disconnects the speakers automatically. Adjust the volume using the VOLUME buttons.

Troubleshooting Chart

Many potential "problems" can be resolved by the owner without calling a service technician.

If something is wrong with this product, check the following before calling your authorized SHARP dealer or service center.

■ General

Symptom	Possible cause
<ul style="list-style-type: none"> The clock is not on time. 	<ul style="list-style-type: none"> Did a power failure occur? Reset the clock. (Refer to page 15.)
<ul style="list-style-type: none"> When a button is pressed, the unit does not respond. 	<ul style="list-style-type: none"> Set this unit to the power stand-by mode and then turn it back on. If the unit still malfunctions, reset it. (Refer to step 3 under "If trouble occurs" on page 30.)
<ul style="list-style-type: none"> No sound is heard. 	<ul style="list-style-type: none"> Is the volume level set to "0"? Are the headphones connected? Are the speaker wires disconnected?

■ CD player

Symptom	Possible cause
<ul style="list-style-type: none"> Playback does not start. 	<ul style="list-style-type: none"> Is the disc loaded upside-down?
<ul style="list-style-type: none"> Playback stops in the middle or is not performed properly. 	<ul style="list-style-type: none"> Does the disc satisfy the standards? Is the disc distorted or scratched?
<ul style="list-style-type: none"> Playback sounds are skipped, or stopped in the middle of a track. 	<ul style="list-style-type: none"> Is the unit located near excessive vibrations? Is the disc very dirty? Has condensation formed inside the unit?

■ Tuner

Symptom	Possible cause
<ul style="list-style-type: none"> Radio makes unusual noise consecutively. 	<ul style="list-style-type: none"> Is the unit placed near the TV or computer? Is the FM/AM loop antenna placed properly? Move the AC power cord away from the antenna if located near.

■ Cassette deck

Symptom	Possible cause
<ul style="list-style-type: none"> Cannot record. 	<ul style="list-style-type: none"> Is the erase-protection tab removed?
<ul style="list-style-type: none"> Cannot record tracks with proper sound quality. Cannot erase completely. 	<ul style="list-style-type: none"> Is it a normal tape? (You cannot record on a metal or CrO₂ tape.)
<ul style="list-style-type: none"> Sound skipping. 	<ul style="list-style-type: none"> Is there any slack? Is the tape stretched?
<ul style="list-style-type: none"> Cannot hear treble. Sound fluctuation. 	<ul style="list-style-type: none"> Are the capstans, pinch rollers, or heads dirty?
<ul style="list-style-type: none"> Cannot remove the tape. 	<ul style="list-style-type: none"> If a power failure occurs during playback, the heads remain engaged with the tape. Do not open the compartment forcibly. Wait until electricity resumes.

■ Remote control

Symptom	Possible cause
<ul style="list-style-type: none"> The remote control does not operate. 	<ul style="list-style-type: none"> Is the AC power cord of the unit plugged in? Is the battery polarity respected? Are the batteries dead? Is the distance or angle incorrect? Does the remote control sensor receive strong light?

■ Condensation

Sudden temperature changes, storage or operation in an extremely humid environment may cause condensation inside the cabinet (CD pickup, tape heads, etc.) or on the transmitter on the remote control.

Condensation can cause the unit to malfunction. If this happens, leave the power on with no disc (or cassette) in the unit until normal playback is possible (about 1 hour). Wipe off any condensation on the transmitter with a soft cloth before operating the unit.

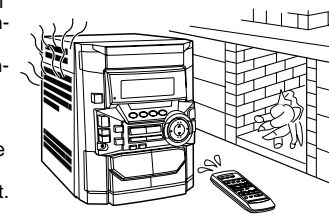

Troubleshooting Chart (continued)

■ If trouble occurs

When this product is subjected to strong external interference (mechanical shock, excessive static electricity, abnormal supply voltage due to lightning, etc.) or if it is operated incorrectly, it may malfunction.

If such a problem occurs, do the following:

- 1 Set the unit to the stand-by mode and turn the power on again.
- 2 If the unit is not restored in step 1, unplug and plug in the unit, and then turn the power on.
- 3 If neither step 1 nor 2 restores the unit, do the following:
 - ① Press the ON/STAND-BY button to enter the power stand-by mode.
 - ② While pressing down the ► / ◄ button and the X-BASS/DEMO button, press the ON/STAND-BY button until "CLEAR AL" appears.



Caution:

This operation will erase all data stored in memory including clock, timer settings, tuner preset, and CD program.

■ Before transporting the unit

- 1 Press the ON/STAND-BY button to turn the power on.
- 2 Press the CD button.
- 3 Press the ▲ OPEN/CLOSE button to open the disc tray. Remove all CDs inserted in the unit.
- 4 Press the ▲ OPEN/CLOSE button to close the disc tray. Make sure that "NO DISC" is displayed.
- 5 Press the ON/STAND-BY button to enter the stand-by mode, and then unplug the AC power cord from the AC outlet.

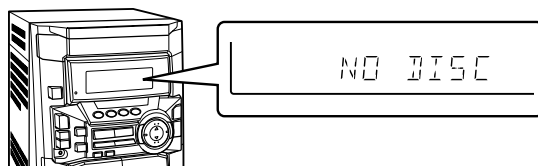

Maintenance

■ Cleaning the tape-handling parts

- Dirty heads, capstans or pinch rollers can cause poor sound and tape jams. Clean these parts with a cotton swab moistened with commercial head/pinch roller cleaner or isopropyl alcohol.
- When cleaning the heads, pinch rollers, etc., unplug the unit which contains high voltages.

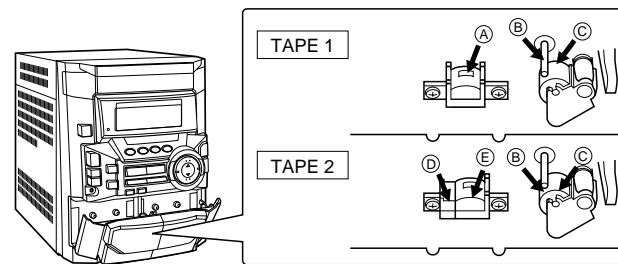

- | | |
|-----------------|---------------------------|
| A Playback head | D Erase head |
| B Capstan | E Recording/Playback head |
| C Pinch roller | |

- After long use, the deck's heads and capstans may become magnetized, causing poor sound. Demagnetize these parts once every 30 hours of playing/recording time by using a commercial tape head demagnetizer. Read the demagnetizer's instructions carefully before use.

■ Cleaning the CD pickup lens

In order to ensure proper operation of the CD player, preventative maintenance (cleaning of the laser pickup lens) should be performed periodically. Lens cleaners are commercially available. Contact your local CD software dealer for options.

■ Cleaning the cabinet

Periodically wipe the cabinet with a soft cloth and a diluted soap solution, then with a dry cloth.

Caution:

Do not use oil, solvents, gasoline, paint thinners or insecticides on the unit.

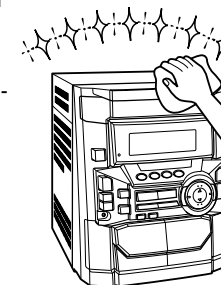

Specifications

As part of our policy of continuous improvement, SHARP reserves the right to make design and specification changes for product improvement without prior notice. The performance specification figures indicated are nominal values of production units. There may be some deviations from these values in individual units.

■ General

Power source	AC 120 V, 60 Hz
Power consumption	128 W
Dimensions	Width: 10-5/8" (270 mm) Height: 13" (330 mm) Depth: 13-7/16" (340 mm)
Weight	13.8 lbs. (6.3 kg)

■ Amplifier

Output power	75 watts minimum RMS per channel into 6 ohms from 60 Hz to 20 kHz, 10% total harmonic distortion
Output terminals	Speakers: 6 ohms Headphones: 16 - 50 ohms (recommended: 32 ohms)
Input terminals	Video/Auxiliary (audio signal): 500 mV/47 kohms

■ CD player

Type	3-disc multi-play compact disc player
Signal readout	Non-contact, 3-beam semiconductor laser pickup
D/A converter	1-bit D/A converter
Frequency response	20 - 20,000 Hz
Dynamic range	90 dB (1 kHz)

■ Tuner

Frequency range	FM: 87.5 - 108 MHz AM: 530 - 1,720 kHz
------------------------	---

■ Cassette deck

Frequency response	50 - 14,000 Hz (Normal tape)
Signal/noise ratio	55 dB (TAPE 1, playback) 50 dB (TAPE 2, recording/playback)
Wow and flutter	0.3 % (WRMS)

■ Speaker

Type	2-way type speaker system 2" (5 cm) Tweeter 3-15/16" (10 cm) Woofer
Maximum input power	150 W
Rated input power	75 W
Impedance	6 ohms
Dimensions	Width: 8-11/16" (220 mm) Height: 13" (330 mm) Depth: 8-9/16" (217 mm)
Weight	6.6 lbs. (3.0 kg)/each



CONSUMER LIMITED WARRANTY

SHARP ELECTRONICS CORPORATION warrants to the first consumer purchaser that this Sharp brand product (the "Product"), when shipped in its original container, will be free from defective workmanship and materials, and agrees that it will, at its option, either repair the defect or replace the defective Product or part thereof with a new or remanufactured equivalent at no charge to the purchaser for parts or labor for the period(s) set forth below.

This warranty does not apply to any appearance items of the Product nor to the additional excluded item(s) set forth below nor to any Product the exterior of which has been damaged or defaced, which has been subjected to improper voltage or other misuse, abnormal service or handling, or which has been altered or modified in design or construction.

In order to enforce the rights under this limited warranty, the purchaser should follow the steps set forth below and provide proof of purchase to the servicer.

The limited warranty described herein is in addition to whatever implied warranties may be granted to purchasers by law. ALL IMPLIED WARRANTIES INCLUDING THE WARRANTIES OF MERCHANTABILITY AND FITNESS FOR USE ARE LIMITED TO THE PERIOD(S) FROM THE DATE OF PURCHASE SET FORTH BELOW. Some states do not allow limitations on how long an implied warranty lasts, so the above limitation may not apply to you.

Neither the sales personnel of the seller nor any other person is authorized to make any warranties other than those described herein, or to extend the duration of any warranties beyond the time period described herein on behalf of Sharp.

The warranties described herein shall be the sole and exclusive warranties granted by Sharp and shall be the sole and exclusive remedy available to the purchaser. Correction of defects, in the manner and for the period of time described herein, shall constitute complete fulfillment of all liabilities and responsibilities of Sharp to the purchaser with respect to the Product, and shall constitute full satisfaction of all claims, whether based on contract, negligence, strict liability or otherwise. In no event shall Sharp be liable, or in any way responsible, for any damages or defects in the Product which were caused by repairs or attempted repairs performed by anyone other than an authorized servicer. Nor shall Sharp be liable or in any way responsible for any incidental or consequential economic or property damage. Some states do not allow the exclusion of incidental or consequential damages, so the above exclusion may not apply to you.

THIS WARRANTY GIVES YOU SPECIFIC LEGAL RIGHTS. YOU MAY ALSO HAVE OTHER RIGHTS WHICH VARY FROM STATE TO STATE.

Model Specific Section

Your Product Model Number & Description:

CD-BA250/CD-BA2600 Mini Component System

(Be sure to have this information available when you need service for your Product.)

Warranty Period for this Product:

One (1) year parts and labor from the date of purchase.

Additional Item(s) Excluded from Warranty Coverage (if any):

Non-functional accessories, supplies, and consumable items.

Where to Obtain Service:

At a Sharp Authorized Servicer located in the United States.

To find a location of the nearest Sharp Authorized Servicer, call Sharp toll free at 1-800-BE-SHARP.

What to do to Obtain Service:

Ship prepaid or carry in your Product to a Sharp Authorized Servicer.

Be sure to have **Proof of Purchase** available. If you ship the Product, be sure it is insured and packaged securely.

TO OBTAIN SUPPLY, ACCESSORY OR PRODUCT INFORMATION, CALL **1-800-BE-SHARP**.

SHARP

SHARP ELECTRONICS CORPORATION

Sharp Plaza, Mahwah, New Jersey 07430-2135

SHARP CORPORATION

TINSE0343AWZZ

Printed in Malaysia
A0012.HK