

**SHARP**

**COMPACT AUDIO SYSTEM**

MODEL

**XL-3000**

**OPERATION MANUAL**

COMPACT  
**disc**  
DIGITAL AUDIO

XL3000(FRONT)

1



**Thank you for purchasing this SHARP product.  
To obtain the best performance from this product, please  
read this manual carefully. It will guide you in operating  
your SHARP product.**

XL-3000 Compact Audio System consisting of XL-3000 (main  
unit) and CP-XL3000U (speaker system).

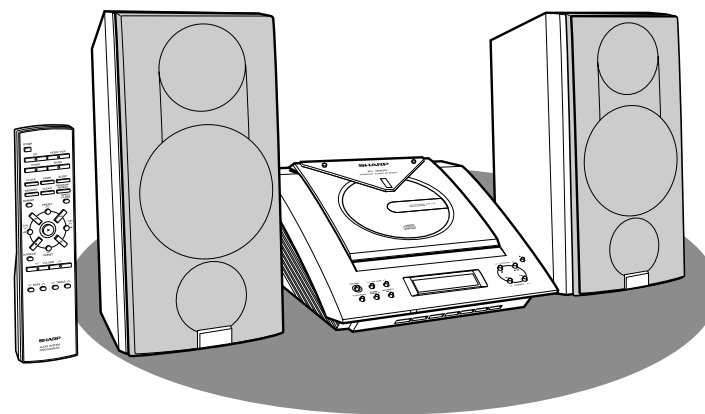

01.2.14, 10:25 AM

## Special Notes



**CAUTION**  
RISK OF ELECTRIC SHOCK  
DO NOT OPEN



**CAUTION: TO REDUCE THE RISK OF ELECTRIC SHOCK, DO NOT REMOVE COVER (OR BACK). NO USER-SERVICEABLE PARTS INSIDE. REFER SERVICING TO QUALIFIED SERVICE PERSONNEL.**

### Explanation of Graphical Symbols:



The lightning flash with arrowhead symbol, within an equilateral triangle, is intended to alert the user to the presence of uninsulated "dangerous voltage" within the product's enclosure that may be of sufficient magnitude to constitute a risk of electric shock to persons.



The exclamation point within an equilateral triangle is intended to alert the user to the presence of important operating and maintenance (servicing) instructions in the literature accompanying the appliance.

**WARNING: TO REDUCE THE RISK OF FIRE OR ELECTRIC SHOCK, DO NOT EXPOSE THIS APPLIANCE TO RAIN OR MOISTURE.**

**Caution - use of controls or adjustments or performance of procedures other than those specified herein may result in hazardous radiation exposure.**

### NOTE

This equipment has been tested and found to comply with the limits for a Class B digital device, pursuant to Part 15 of the FCC Rules. These limits are designed to provide reasonable protection against harmful interference in a residential installation. This equipment generates, uses, and can radiate radio frequency energy and, if not installed and used in accordance with the instructions, may cause harmful interference to radio communications. However, there is no guarantee that interference will not occur in a particular installation. If this equipment does cause harmful interference to radio or television reception, which can be determined by turning the equipment off and on, the user is encouraged to try to correct the interference by one or more of the following measures:

- Reorient or relocate the receiving antenna.
- Increase the separation between the equipment and receiver.
- Connect the equipment into an outlet on a circuit different from that to which the receiver is connected.
- Consult the dealer or an experienced radio/TV technician for help.

### WARNING

FCC Regulations state that any unauthorized changes or modifications to this equipment not expressly approved by the manufacturer could void the user's authority to operate this equipment.

### "Note to CATV system installer:

This reminder is provided to call the CATV system installer's attention to Article 820-40 of the National Electrical Code that provides guidelines for proper grounding and, in particular, specifies that the cable ground shall be connected to the grounding system of the building, as close to the point of cable entry as practical.

### FOR YOUR RECORDS

For your assistance in reporting this unit in case of loss or theft, please record below the model number and serial number which are located on the bottom of the unit. Please retain this information.

**Model number** .....

**Serial number** .....

**Date of purchase** .....

**Place of purchase** .....

# Important Safeguards

### CAUTION

All the safety and operating instructions should be read before the appliance is operated, and should be retained for future reference.

Electrical energy can perform many useful functions. This unit has been engineered and manufactured to assure your personal safety. Improper use can result in potential electrical shock or fire hazards. In order not to defeat the safeguards, observe the following basic rules for its installation, use and servicing.

- 1 Heed Warnings - All warnings on the appliance and in the operating instructions should be adhered to.
- 2 Follow Instructions - All operating and use instructions should be followed.
- 3 Water and Moisture - The appliance should not be used near water - for example, near a bathtub, washbowl, kitchen sink, laundry tub, in a wet basement, or near a swimming pool, etc.
- 4 Carts and Stands - The appliance should be used only with a cart or stand that is recommended by the manufacturer.
  - An appliance and cart combination should be moved with care. Quick stops, excessive force, and uneven surfaces may cause the appliance and cart combination to overturn.
- 5 Wall or Ceiling Mounting - The appliance should be mounted to a wall or ceiling only as recommended by the manufacturer.
- 6 Ventilation - The appliance should be situated so that its location or position does not interfere with its proper ventilation. For example, the appliance should not be situated on a bed, sofa, rug, or similar surface that may block the ventilation openings; or, placed in a built-in installation, such as a bookcase or cabinet that may impede the flow of air through the ventilation openings.
- 7 Heat - The appliance should be situated away from heat sources such as radiators, heat registers, stoves, or other appliances (including amplifiers) that produce heat.
- 8 Power Sources - The appliance should be connected to a power supply only of the type described in the operating instructions or as marked on the appliance.
- 9 Power-Cord Protection - Power-supply cords should be routed so that they are not likely to be walked on or pinched by items placed upon or against them, paying particular attention to cords at plugs, convenience receptacles, and the point where they exit from the appliance.
- 10 Do not use liquid cleaners or aerosol cleaners. Use a damp cloth for cleaning.
- 11 Power Lines - An outdoor antenna should be located away from power lines.



- 12 Outdoor Antenna Grounding - If an outside antenna is connected to the receiver, be sure the antenna system is grounded so as to provide some protection against voltage surges and built-up static charges. Section 810 of the National Electrical Code, ANSI/NFPA No. 70-1984, provides information with respect to proper grounding of the mast and supporting structure, grounding of the lead-in wire to an antenna discharge unit, size of grounding conductors, location of antenna-discharge unit, connection to grounding electrodes, and requirements for the grounding electrode.

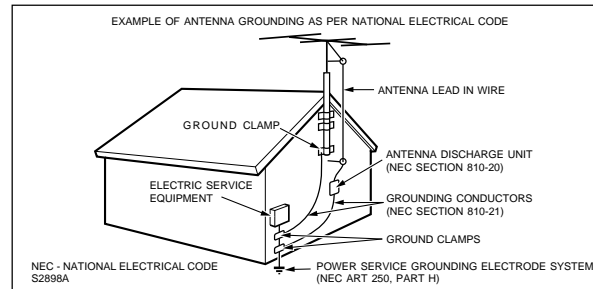

- 13 Nonuse Periods - The power cord of the appliance should be unplugged from the outlet when left unused for a long period of time.
- 14 Object and Liquid Entry - Care should be taken so that objects do not fall and liquids are not spilled into the enclosure through openings.
- 15 Damage Requiring Service - The appliance should be serviced by qualified service personnel when:
  - A The power-supply cord or the plug has been damaged; or
  - B Objects have fallen, or liquid has been spilled into the appliance; or
  - C The appliance has been exposed to rain; or
  - D The appliance does not appear to operate normally or exhibits a marked change in performance; or
  - E The appliance has been dropped, or the enclosure damaged.
- 16 Servicing - The user should not attempt to service the appliance beyond that described in the operating instructions. All other servicing should be referred to qualified service personnel.
- 17 Grounding or Polarization - Precautions should be taken so that the grounding or polarization means of an appliance is not defeated.

## Contents

	Page		Page
<b>■ General Information</b>		<b>■ Radio</b>	
Precautions .....	5, 6	Listening to the Radio .....	22, 23
Accessories .....	6	Listening to the memorized station .....	24
Controls and Indicators .....	7 - 10	<b>■ Advanced Features</b>	
<b>■ Preparation for Use</b>		Timer and Sleep Operation .....	25 - 27
Remote Control .....	11	Enhancing Your System .....	28
System Connections .....	12 - 14	<b>■ References</b>	
<b>■ Basic Operation</b>		Troubleshooting Chart .....	29, 30
General Control .....	15	Maintenance .....	30
Sound Control .....	16	Specifications .....	31
Setting the Clock .....	17	<b>CONSUMER LIMITED WARRANTY</b> .....	
<b>■ CD Playback</b>		Back cover	
Listening to a CD .....	18 - 20		
Repeat or Random Play .....	20		
Programmed Play .....	21		

### ENERGY STAR® Program Information

As an ENERGY STAR® Partner, SHARP has determined that this product meets the ENERGY STAR® guidelines for energy efficiency. ENERGY STAR® is a U.S. registered mark.



#### WHY PURCHASE ENERGY STAR® LABELED PRODUCTS?

Many Electrical /Electronic Products use energy both when they are on and when they are off. Americans spend more than \$3 billion a year on energy consumed by home electronic products when they are not in use. The new ENERGY STAR® labeled models will reduce that energy "leakage" by up to 75 percent. Ultimately, this will mean more than \$1 billion a year in energy savings for consumers.

The energy savings will help reduce the burning of fossil fuels and the related carbon dioxide pollution that contributes to global warming. If every American family replaced their electronic equipment with ENERGY STAR® labeled models, it would reduce air pollution equivalent to eliminating more than two million cars.

By using ENERGY STAR® labeled products, you will save money on your electric bills and use less energy. That makes good economic sense and it's good for our environment.

**ENERGY STAR® is a U.S. registered mark.**

## Precautions

### ■ General

- Please ensure that the equipment is positioned in a well-ventilated area and that there is at least 4" (10 cm) of free space along the sides and back. There must also be a minimum of 12" (30 cm) of free space on the top of the unit.

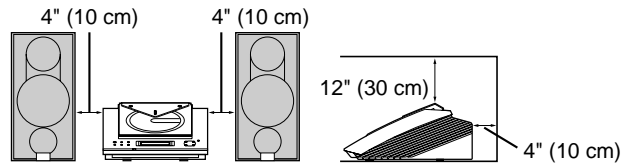

- Use the unit on a firm, level surface free from vibration.



- Keep the unit away from direct sunlight, strong magnetic fields, excessive dust, humidity and electronic/electrical equipment (home computers, facsimiles, etc.) which generates electrical noise.



- Do not place anything on top of the unit.
- Do not expose the unit to moisture, to temperatures higher than 140°F (60°C) or to extremely low temperatures.
- If your system does not work properly, disconnect the AC power cord from the AC outlet. Plug the AC power cord back in, and then turn on your system.

- In case of an electrical storm, unplug the unit for safety.

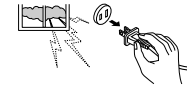

- Hold the AC power plug by the head when removing it from the AC outlet, as pulling the cord can damage internal wires.

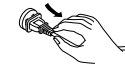

- **Do not remove the outer cover, as this may result in electric shock. Refer internal service to your local SHARP service facility.**

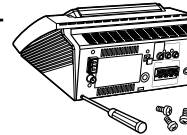

- This unit should only be used within the range of 41°F - 95°F (5°C - 35°C).

### Warnings:

- The voltage used must be the same as that specified on this unit. Using this product with a higher voltage other than that which is specified is dangerous and may result in a fire or other type of accident causing damage. SHARP will not be held responsible for any damage resulting from use of this unit with a voltage other than that which is specified.
- **CD players use a laser pickup which can damage the eyes if viewed directly. Do not look at the pickup, and do not touch the pickup directly.**

### ■ Volume control

The sound level at a given volume setting depends on speaker efficiency, location and various other factors. It is advisable to avoid exposure to high volume levels, which occurs while turning the unit on with the volume control setting up high, or while continually listening at high volumes.

## Precautions (continued)

### ■ Care of compact discs

Compact discs are fairly resistant to damage, however mistracking can occur due to an accumulation of dirt on the disc surface. Follow the guidelines below for maximum enjoyment from your CD collection and player.

- Do not write on either side of the disc, particularly the non-label side from which signals are read. Do not mark this surface.
- Keep your discs away from direct sunlight, heat, and excessive moisture.
- Always hold the CDs by the edges. Fingerprints, dirt, or water on the CDs can cause noise or mistracking. If a CD is dirty or does not play properly, clean it with a soft, dry cloth, wiping straight out from the center, along the radius.

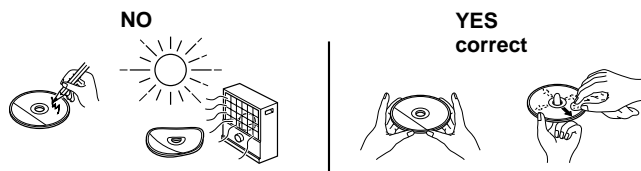

### ■ Condensation

Sudden temperature changes, storage or operation in an extremely humid environment may cause condensation inside the cabinet (CD pickup, etc.) or on the transmitter on the remote control. Condensation can cause the unit to malfunction. If this happens, leave the power on with no disc in the unit until normal playback is possible (about 1 hour). Wipe off any condensation on the transmitter with a soft cloth before operating the unit.



## Accessories

Please confirm that the following accessories are included.

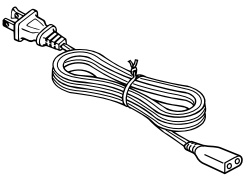
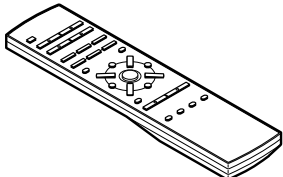
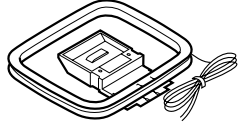
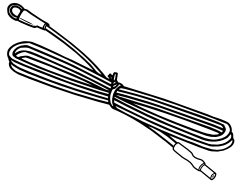
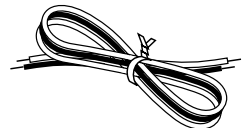
 <p><b>AC power cord × 1</b> (QACCD0001SJ00)</p>	 <p><b>Remote control × 1</b> (RRMCG0029SJSA)</p>
 <p><b>AM loop antenna × 1</b> (QANTL0001SJZZ)</p>	 <p><b>FM antenna × 1</b> (QANTW0002SJZZ)</p>
 <p><b>Speaker wire × 2</b> (QCNWH0005SJZZ)</p>	

**Note:**  
Only the above accessories are included.

# Controls and Indicators

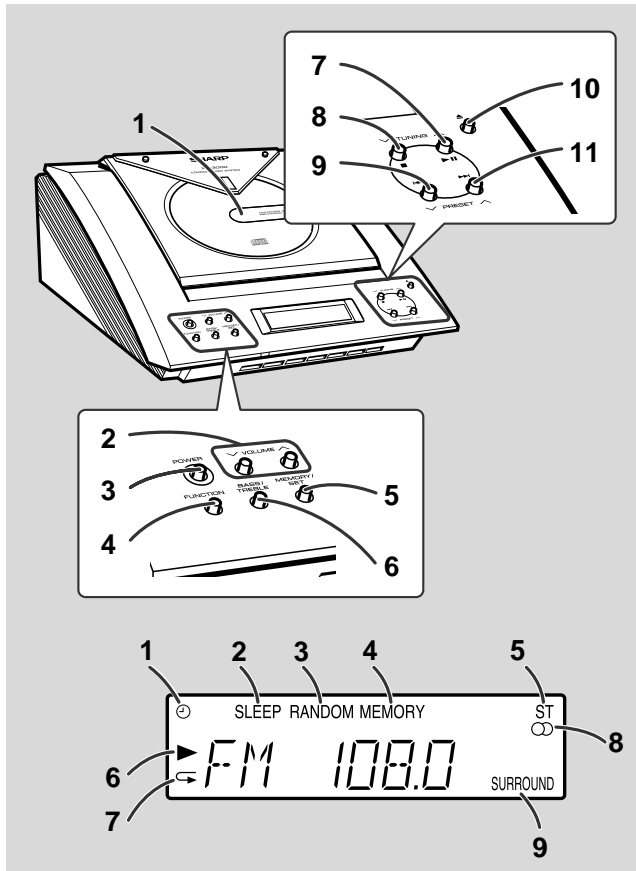

## ■ Front panel

	Reference page
1. CD Compartment .....	18
2. Volume Up and Down Buttons .....	16
3. Power Button .....	15
4. Function Selector Button .....	18, 22, 28
5. Memory/Set Button .....	21, 24
6. Bass/Treble Selector Button .....	16
7. CD Play or Pause, Tuning Up Button .....	18, 19, 22
8. CD Stop, Tuning Down Button .....	19, 22
9. CD Track Down or Fast Reverse, Tuner Preset Down Button .....	20, 24
10. CD Open/Close Button .....	15
11. CD Track Up or Fast Forward, Tuner Preset Up Button .....	20, 24

## ■ Display

- 1. Timer Play Indicator
- 2. Sleep Indicator
- 3. CD Random Play Indicator
- 4. Memory Indicator
- 5. FM Stereo Mode Indicator
- 6. CD Play Indicator
- 7. CD Repeat Play Indicator
- 8. FM Stereo Receiving Indicator
- 9. Surround Indicator

■ Description of remote control (See page 9.)

## Controls and Indicators (continued)

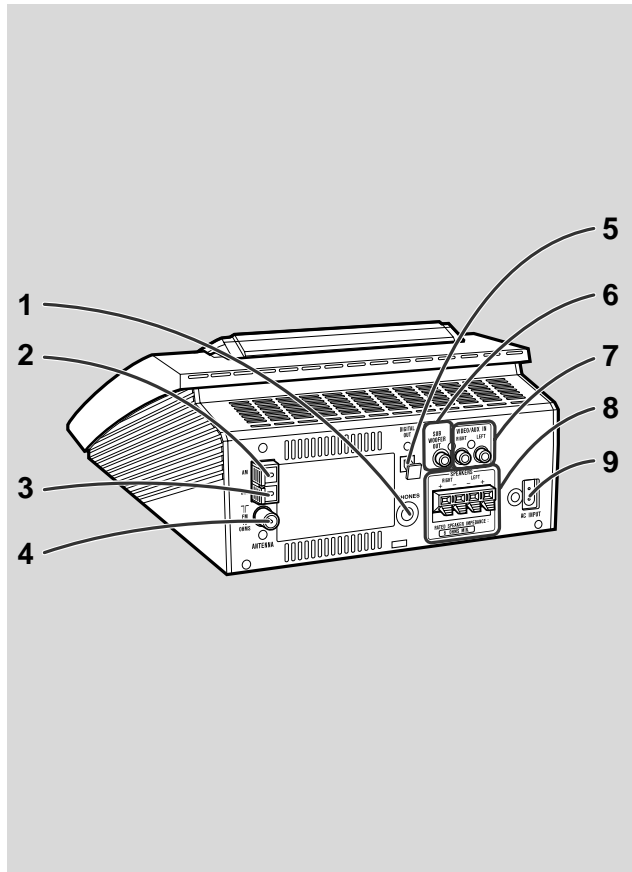

### ■ Rear panel

	Reference page
1. Headphone Jack	28
2. AM Antenna Terminal	12, 13
3. Antenna Earth Terminal	12, 13
4. FM 75 Ohms Antenna Jack	12, 13
5. CD Digital Output Jack	28
6. Subwoofer Output Jack	14
7. Video/Auxiliary (Audio Signal) Input Jacks	28
8. Speaker Terminals	12, 14
9. AC Power Input Jack	12, 14



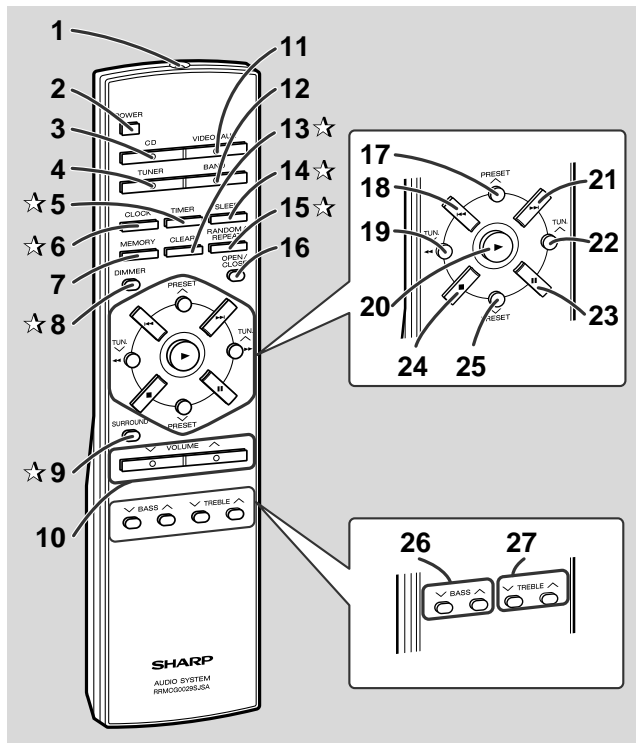

Buttons with "☆" mark in the illustration can be operated on the remote control only.  
 Other buttons can be operated both on the main unit and the remote control.

### ■ Remote control

	Reference page
1. Remote Control Transmitter .....	11
2. Power Button .....	15
3. CD Button .....	18
4. Tuner Button .....	22
5. <b>Timer Button</b> .....	<b>25</b>
6. <b>Clock Button</b> .....	<b>17</b>
7. Memory Button .....	17, 21, 24
8. <b>Dimmer Button</b> .....	<b>15</b>
9. <b>Surround Button</b> .....	<b>16</b>
10. Volume Up and Down Buttons .....	16
11. Video/Auxiliary Button .....	28
12. Band Selector Button .....	22
13. <b>Clear Button</b> .....	<b>21</b>
14. <b>Sleep Button</b> .....	<b>27</b>
15. <b>Random/Repeat Button</b> .....	<b>20</b>
16. CD Open/Close Button .....	15
17. Tuner Preset Up Button .....	24
18. CD Track Down Button .....	20
19. CD Fast Reverse, Tuning Down Button .....	20, 22
20. CD Play Button .....	18
21. CD Track Up Button .....	20
22. CD Fast Forward, Tuning Up Button .....	20, 22
23. CD Pause Button .....	19
24. CD Stop Button .....	19
25. Tuner Preset Down Button .....	24
26. Bass Up and Down Buttons .....	16
27. Treble Up and Down Buttons .....	16

■ Battery installation for remote control (See page 11.)

## Controls and Indicators (continued)

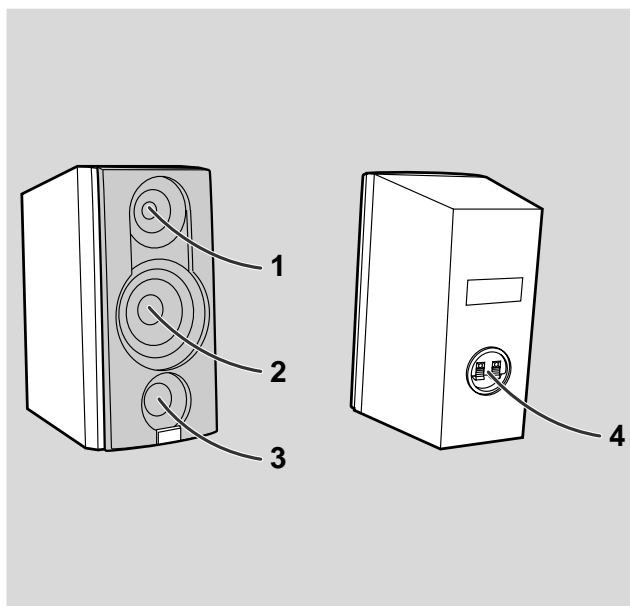

### ■ Speaker system

1. Tweeter
2. Woofer
3. Bass Reflex Duct
4. Speaker Terminals

#### Speaker grilles are removable:

Make sure nothing comes into contact with the speaker diaphragms when you remove the speaker grilles.

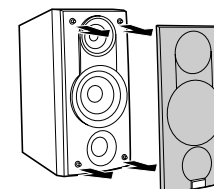

#### Placing the speaker system: Left speaker

There is no distinction between the right and the left speakers.

#### Right speaker

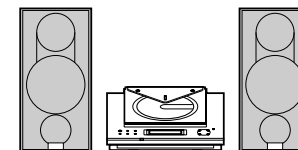

#### Notes:

- The speakers are magnetically shield. Therefore, they do not affect the display even if you use them near the TV. However, some color variation may occur, depending on the type of TV used.

#### If color variation occurs...

Turn off the TV (from the power switch).  
After 15 - 30 minutes, turn the TV on again.

#### If the color variation is still present...

Move the speakers further away from the TV.

- If any kind of magnet or an electromagnet is placed too close to the TV and the system, irregular colors may appear on the TV screen.

# Remote Control

## ■ Battery installation

Use 2 "AAA" size batteries (UM-4, R03, HP-16 or similar).  
Batteries are not included.

- 1 Remove the battery cover.
- 2 Insert the batteries according to the direction indicated in the battery compartment.  
When inserting or removing the batteries, push them toward the ⊖ battery terminals.
- 3 Replace the cover.

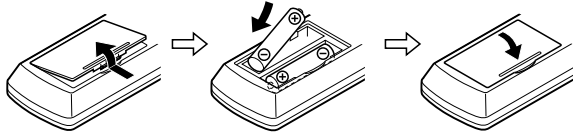

### Precautions for battery use:

- Replace all old batteries with new ones at the same time.
- Do not mix old and new batteries.
- Remove the batteries if the unit will not be used for long periods of time. This will prevent potential damage due to battery leakage.

### Caution:

- Do not use rechargeable batteries (nickel-cadmium battery, etc.).
- Installing the batteries incorrectly may cause the unit to malfunction.

### Notes concerning use:

- Replace the batteries if the operating distance is reduced or if the operation becomes erratic.
- Periodically clean the transmitter on the remote control and the sensor on the unit with a soft cloth.
- Exposing the sensor on the unit to strong light may interfere with operation. Change the lighting or the direction of the unit.
- Keep the remote control away from moisture, heat, shock, and vibrations.

## ■ Test of the remote control

Check the remote control after checking all connections have been correctly. (See pages 12 - 14.)

Face the remote control directly to the remote sensor on the unit.

**The remote control can be used within the range shown below:**

Press the POWER button. Does the power turn on? Now, you can enjoy the music.

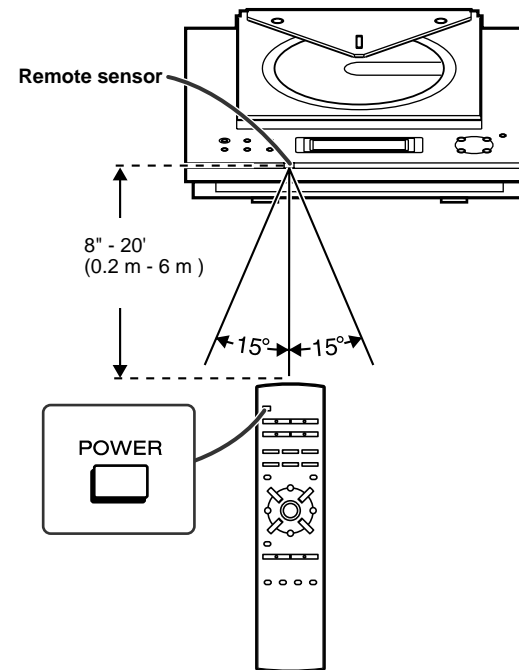

## System Connections

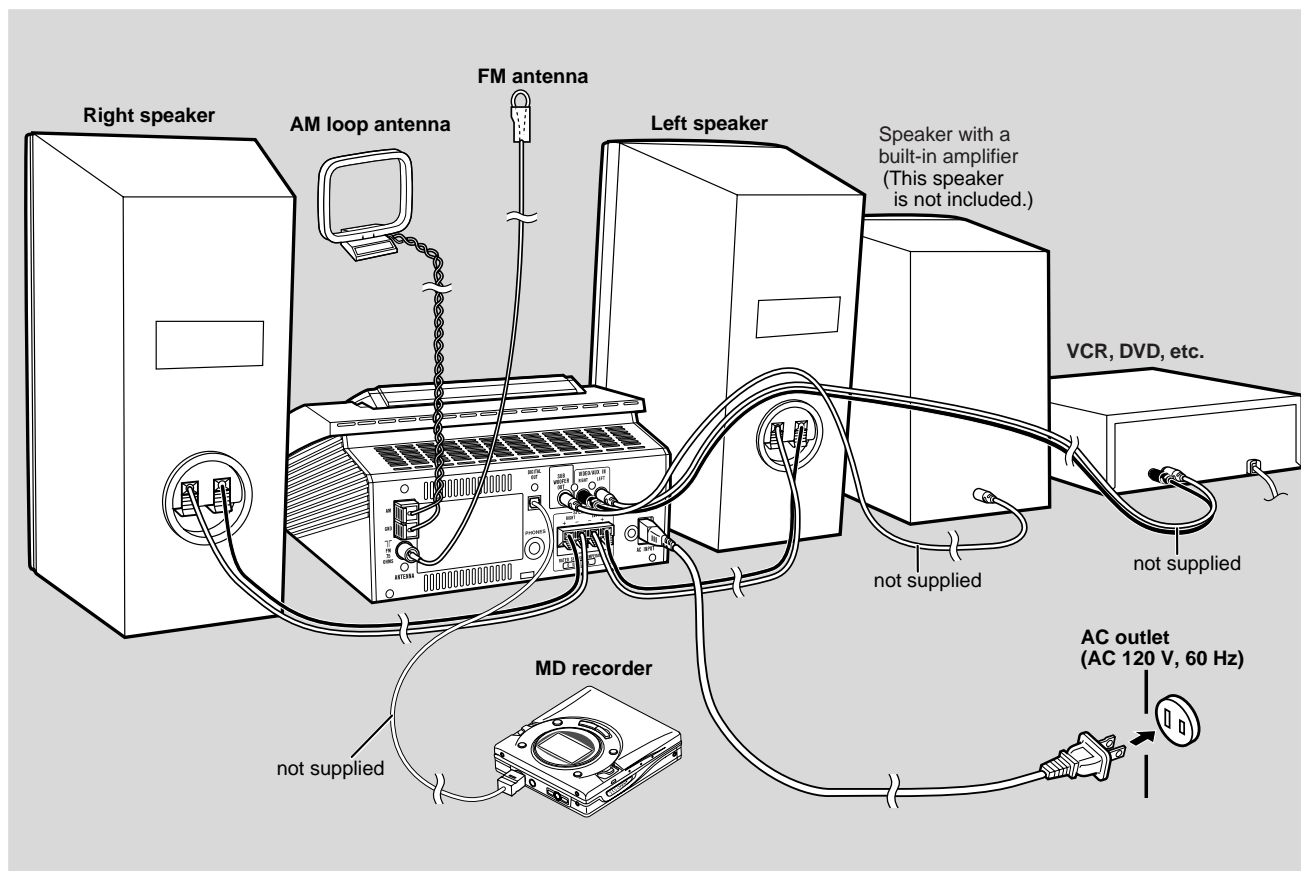

## ■ Antenna connection

### Supplied FM antenna:

Connect the FM antenna wire to the FM 75 OHMS jack and position the FM antenna wire in the direction where the strongest signal can be received.

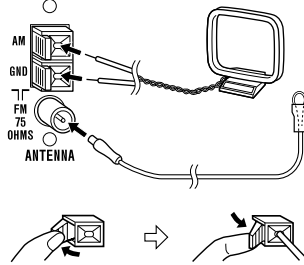

### Supplied AM loop antenna:

Connect the AM loop antenna wire to the AM and GND terminals. Position the AM loop antenna for optimum reception. Place the AM loop antenna on a shelf, etc., or attach it to a stand or a wall with screws (not supplied).

### Notes:

- Placing the antenna on the unit or near the AC power cord may cause noise pickup. Place the antenna away from the unit for better reception.
- When static is still heard even after adjusting the position of the AM loop antenna, try reversing the wire connections.

### Installing the AM loop antenna:

< Assembling >

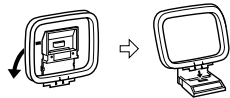

< Attaching to the wall >

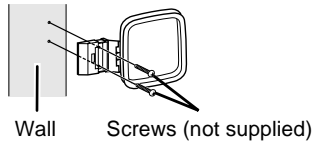

### Outdoor FM or AM antenna:

Use an outdoor FM or AM antenna if you require better reception. Consult your dealer.

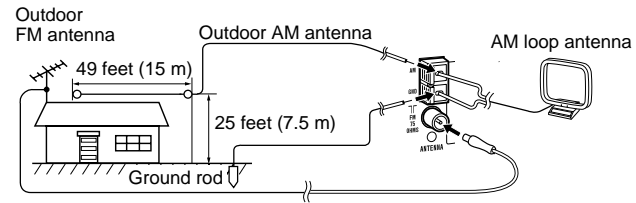

### Notes:

- When an outdoor FM antenna is used, disconnect the supplied FM antenna wire from the FM 75 OHMS jack.
- When using an outdoor AM antenna, be sure to keep the wire of the AM loop antenna connected.

## System Connections (continued)

### ■ Speaker connection

Connect the wire with the white line to the minus (-) terminal and the black wire to the plus (+) terminal.

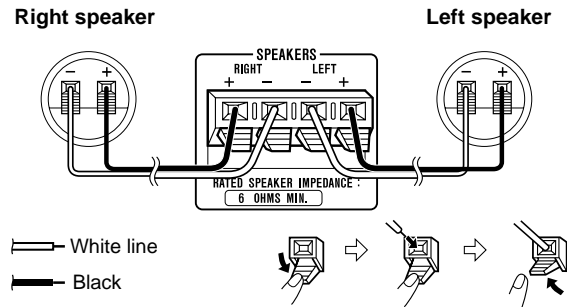

#### Caution:

- Connect the speaker wires to the speakers first, then to the unit.
- Use speakers with an impedance of 6 ohms or more, as lower impedance speakers can damage the unit.
- Do not mistake the right and the left channels. The right speaker is the one on the right side when you face the unit.
- Do not let the bare speaker wires touch each other.

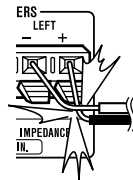

Incorrect

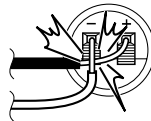

Incorrect

### ■ Subwoofer connection

When a commercially available speaker with a built-in amplifier is connected to this unit, you can enjoy sound with emphasized bass. Connect an RCA cord from a commercially available speaker with a built-in amplifier to the SUBWOOFER OUT jack.

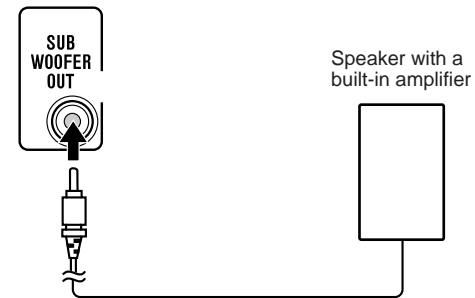

### ■ Connecting the AC power cord

After checking all the connections have been made correctly, connect the AC power cord to the AC power input jack, then plug the AC power cord of this unit into the AC outlet.

#### Notes:

- Unplug the unit if it will not be used for a prolonged period of time.
- Never use a power cord other than the one supplied. Otherwise, a malfunction or an accident may occur.

## General Control

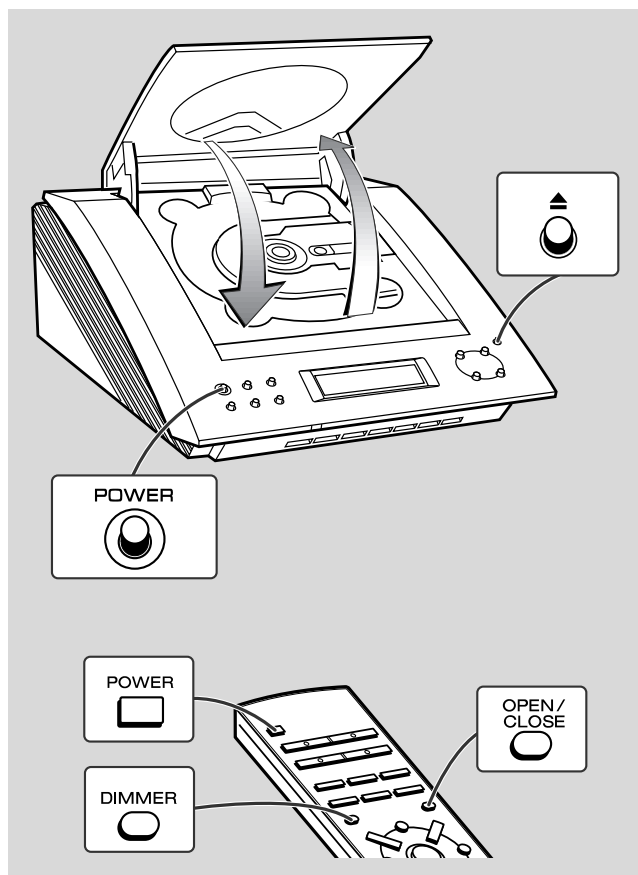

### ■ To turn the power on

Press the POWER button to turn the power on.

### To set the unit to stand-by mode:

Press the POWER button again.

### ■ To change the display brightness (2 levels)

You can switch the display brightness by pressing the DIMMER button on the remote control.

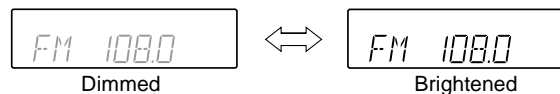

### ■ Opening and closing the CD compartment

The CD compartment cover is motorized.

When the power is turned on, you can open or close the CD compartment cover by pressing the ▲ (OPEN/CLOSE) button.

#### Caution:

- Do not stop or move the CD compartment cover manually. It may cause malfunctions to the unit.
- Be careful not to jam your fingers in the CD compartment cover.

## Sound Control

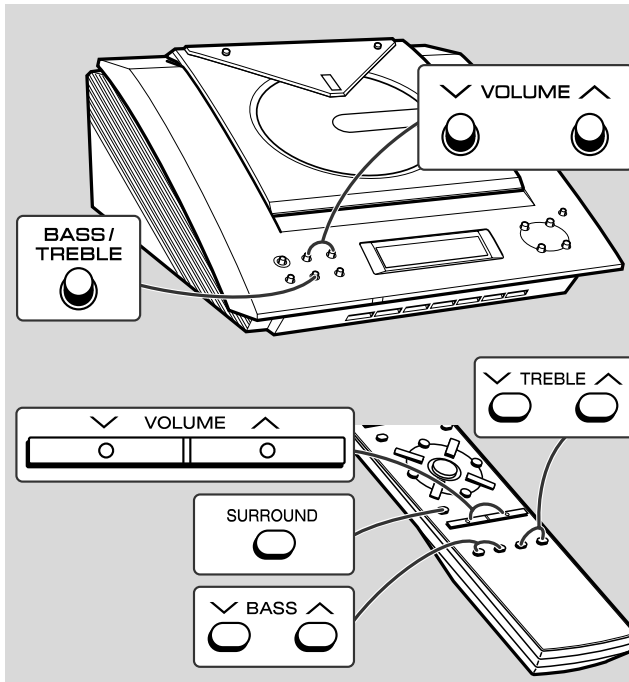

### ■ Adjusting the volume

Press the VOLUME ^ button to increase the volume and the VOLUME v button for decreasing.

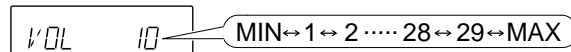

### ■ Adjusting the bass

#### Main unit operation:

- 1 Press the BASS/TREBLE button until "BASS" appears on the display.
- 2 Within 5 seconds, press the VOLUME (v or ^) button to adjust the bass.

#### Remote control operation:

Press the BASS (v or ^) button to adjust the bass.

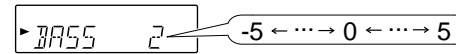

### ■ Adjusting the treble

#### Main unit operation:

- 1 Press the BASS/TREBLE button until "TRE" appears on the display.
- 2 Within 5 seconds, press the VOLUME (v or ^) button to adjust the treble.

#### Remote control operation:

Press the TREBLE (v or ^) button to adjust the treble.

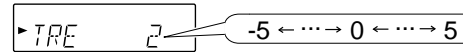

### ■ Setting the surround

Press the SURROUND button to allow you to enjoy music that seems to surround you. "SURROUND" will appear. To cancel the surround mode, press the SURROUND button again.

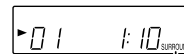

SURROUND Indicator

#### Note:

The surround effect cannot be obtained from monaural sound signals.



## Setting the Clock

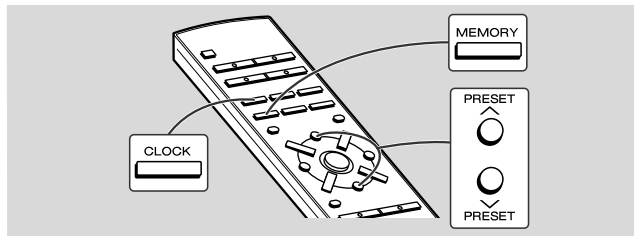

This may be operated only with the remote control.  
In this example, the clock is set for the 12-hour (AM 12:00) display.

- 1** Press the **CLOCK** button and within 3 seconds, press the **MEMORY** button.



- 2** Within 1 minute, press the **PRESET** (∨ or ∧) button to select 12-hour or 24-hour display and then press the **MEMORY** button.



"AM 12:00" → The 12-hour display will appear.  
(AM 12:00 - PM 11:59)

"0:00" → The 24-hour display will appear.  
(0:00 - 23:59)

Note that this can only be set when the unit is first installed or it has been reset. (Refer to step 3 under "If trouble occurs" on page 30.)

- 3** Within 1 minute, press the **PRESET** (∨ or ∧) button to adjust the hour and then press the **MEMORY** button.



- When the 12-hour display is selected, "AM" will change automatically to "PM".

- 4** Within 1 minute, press the **PRESET** (∨ or ∧) button to adjust the minutes and then press the **MEMORY** button.



- The hour will not advance even if minutes advance from "59" to "00".
- The clock starts from "0" second. (Seconds are not displayed.)

**To confirm the time display when the power is on:**

Press the **CLOCK** button.  
The time display will appear for about 5 seconds.

**Note:**

The time will flash at the push of the **CLOCK** button when the AC power supply is restored after a power failure or unplugging the unit. Readjust the clock as follows.

**To readjust the clock:**

Perform "Setting the Clock" from the beginning.

**To change the 12-hour or 24-hour display:**

- 1 Clear all the programmed contents. [Perform to step 3 under "If trouble occurs" on page 30 for details.]
- 2 Perform "Setting the Clock" from the beginning.

## Listening to a CD

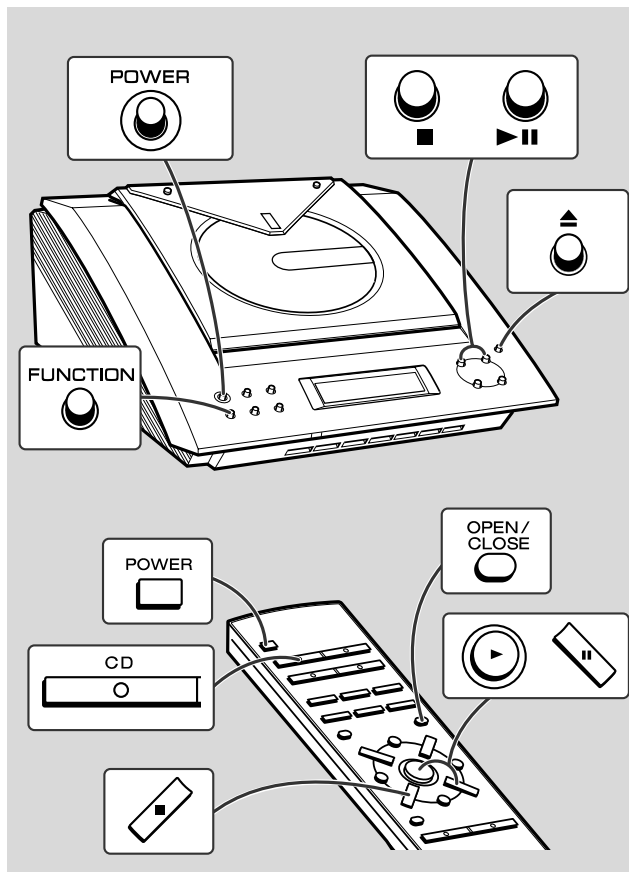

- 1** Press the **POWER** button to turn the power on.
- 2** Press the **FUNCTION** button until "CD STOP" or "NO DISC" appears on the display.  
When operating with the remote control, press the CD button.
- 3** Press the **▲ (OPEN/CLOSE)** button to open the CD compartment.
- 4** Place a CD on the spindle, label side up.  
Be sure to place 3" (8 cm) disc in the middle of a disc holder.
 



5" (12 cm)

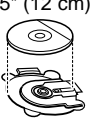

3" (8 cm)

- 5** Press the **▲ (OPEN/CLOSE)** button to close the CD compartment.
 

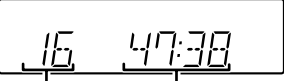

Total number of tracks

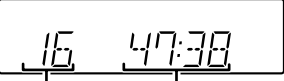

Total playing time
- 6** Press the **▶II (▶)** button to start playback from track 1.  
When the last track on the disc has finished playing, the CD player will stop automatically.

**To interrupt playback:**

**Main unit operation:**

Press the ►|| button.

To resume playback from the same point, press the ►|| button again.

**Remote control operation:**

Press the || button.

To resume playback from the same point, press the ► button.

**To stop playback:**

Press the ■ button.

**To remove the CD:**

While in the stop mode, press the ▲ (OPEN/CLOSE) button.

Press the CD eject button and remove the CD.

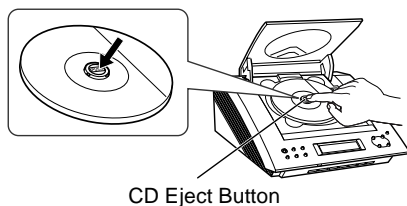

**Notes:**

- After removing the CD, make sure to press the ▲ (OPEN/CLOSE) button and close the CD compartment.
- When the unit enters the stand-by mode, the opened CD compartment cover will be closed automatically.

**After use:**

Press the POWER button to enter the power stand-by mode.

**Caution:**

- Do not stop or move the CD compartment cover manually. It may cause malfunctions to the unit.
- Be careful not to jam your fingers in the CD compartment cover.
- If the power fails while the compartment is open, wait until the power is restored.
- If a disc is damaged, dirty, or loaded upside down, "NO DISC" or "READ ERR" will appear on the display.
- Keep foreign objects out of the CD compartment.
- Subjecting the unit to shock or vibration may cause mistracking.
- When the unit is not being used, be sure to close the CD compartment. If it is left open, the lens may be covered with dust and the unit may not operate properly.
- If TV or radio interference occurs during CD operation, move the unit away from the TV or radio.

## Listening to a CD (continued)

### ■ To locate the beginning of a track

#### To move to the beginning of the next track:

Press the ►| button for less than 0.5 seconds during playback.



- You can skip to any track by pressing the ►| button repeatedly until the desired track number appears.

#### To restart the track being played:

Press the ◀◀ button for less than 0.5 seconds during playback.



- You can skip to any track by pressing the ◀◀ button repeatedly until the desired track number appears.

### ■ To locate the desired portion

#### For audible fast forward:

Press and hold down the ►| button during playback.

#### For audible fast reverse:

Press and hold down the ◀◀ button during playback.

#### Notes:

- Normal playback will resume when the ◀◀ or ►| button is released.
- When the end of the last track is reached during fast forward, "END" will appear on the display and CD operation will be paused. When the beginning of the first track is reached during fast reverse, playback will start when you release the ◀◀ button.
- The ◀◀ or ►| button on the remote control allows you to locate the desired portion.

## Repeat or Random Play

You can select one of the CD playback mode; "Repeat play", "Random play" and "Normal play".

### 1 When in the CD mode, press the RANDOM/REPEAT button on the remote control repeatedly to select the playback mode.

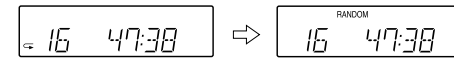

Repeat playback mode      Random playback mode

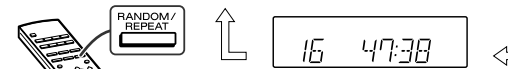

Normal playback mode

### 2 Press the ► button to start playback.

#### To repeat a programmed sequence:

Perform steps 1 - 5 in the "Programmed Play" section and then select the repeat playback.

#### Notes:

- In random play, the CD player will select and play tracks automatically. (You cannot select the order of the tracks.)
- If you press the ►| button during random play, you can move to the track selected next by the random operation. On the other hand, the ◀◀ button does not allow you to move to the previous track. The beginning of the track being played will be located.

#### Caution:

After performing repeat or random play, be sure to press the ■ button. Otherwise, the disc will play continuously.

#### To cancel repeat or random play:

Press the RANDOM/REPEAT button on the remote control repeatedly to select the normal playback mode.

## Programmed Play

By specifying tracks from 1 to 99, you can choose up to 20 selections for playback in the order you like.

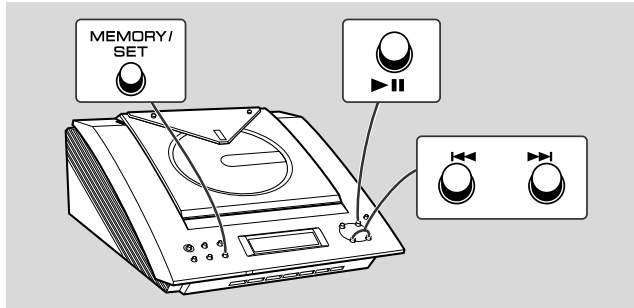

**1** While in the stop mode, press the **MEMORY/SET (MEMORY)** button to enter the programming save mode.

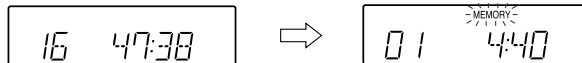

**2** Within 30 seconds, press the **◀◀** or **▶▶** button to select the desired track.

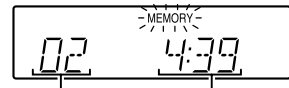

Selected track number      Playback time

**3** Press the **MEMORY/SET (MEMORY)** button to save the track number.



Playback order

Total playback time

**4** Repeat steps 2 - 3 for other tracks. Up to 20 tracks can be programmed.

**5** Press the **▶▶ (▶)** button to start playback.

**To clear the programmed selections:**

Press the **CLEAR** button on the remote control while the "MEMORY" indicator is flashing. Each time the button is pressed, one track will be cleared, beginning with the last track programmed.

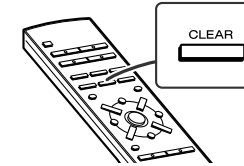

**To cancel the programmed play mode:**

While in the stop mode and the "MEMORY" indicator is lit, press the **CLEAR** button on the remote control. The "MEMORY" indicator will disappear and all the programmed contents will be cleared.

**Adding tracks to the program:**

If a program has been previously stored, the "MEMORY" indicator will be displayed. Then follow steps 1 - 3 to add tracks. The new tracks will be stored after the last track of the original program.

**Notes:**

- Opening the CD compartment automatically cancels the programmed sequence.
- Even if you press the **POWER** button to enter the stand-by mode or the function is changed from CD to some other function, the programmed selections will not be cleared.
- During program operation, random play is not possible.

## Listening to the Radio

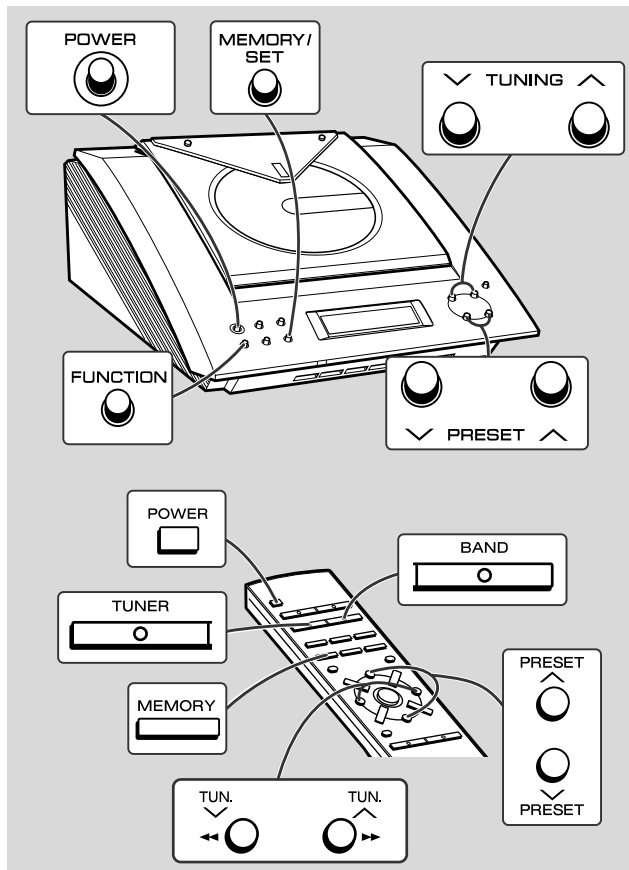

- 1 Press the POWER button to turn the power on.**
  - 2 Press the FUNCTION button until "FM" or "AM" appears on the display.**  
When operating with the remote control, press the TUNER button, and then the BAND button to select "FM" or "AM".
  - 3 Press the TUNING (∨ or ∧) button to tune in to the desired station.**  
**Manual tuning:**  
Press the TUNING button as many times as required to tune in to the desired station.  
**Auto tuning:**  
When the TUNING button is pressed for more than 0.5 seconds, scanning will start automatically and the tuner will stop at the first receivable broadcast station.
- Notes:**
- This can be operated by pressing the TUN. (∨ or ∧) button on the remote control.
  - When radio interference occurs, auto scan tuning may stop automatically at that point.
  - Auto scan tuning will skip weak signal stations.
  - To stop the auto tuning, press the TUNING button again.

**To receive an FM stereo transmission:**

Press the FUNCTION (BAND) button to display the "ST" indicator.

- "∞" will appear when an FM broadcast is in stereo.

FM stereo mode indicator

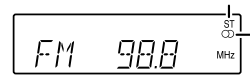

FM stereo receiving indicator

- If the FM reception is weak, press the FUNCTION (BAND) button to extinguish the "ST" indicator. The reception changes to monaural, and the sound becomes clearer.

**After use:**

Press the POWER button to enter the power stand-by mode.

## Listening to the memorized station

### ■ Memorizing a station

You can store 30 AM and FM stations in memory and recall them at the push of a button. (Preset tuning)

**1** Perform the steps 1 - 3 in "Listening to the Radio" on page 22.

**2** Press the MEMORY/SET (MEMORY) button to enter the preset tuning saving mode.

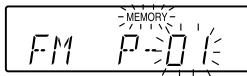

**3** Within 5 seconds, press the PRESET (∨ or ∧) button to select the preset channel number.

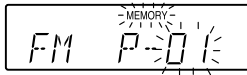

Store the stations in memory, in order, starting with preset channel 1.

**4** Within 5 seconds, press the MEMORY/SET (MEMORY) button to store that station in memory.

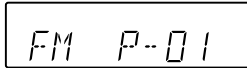

If the "MEMORY" and preset number indicators go out before the station is memorized, repeat the operation from step 2.

**5** Repeat steps 1 - 4 to set other stations, or to change a preset station.

When a new station is stored in memory, the station previously memorized will be erased.

#### Note:

The backup function protects the memorized stations for a few hours should there be a power failure or the AC power cord disconnection.

### ■ To recall a memorized station

Press the PRESET (∨ or ∧) button for less than 0.5 seconds to select the desired station.

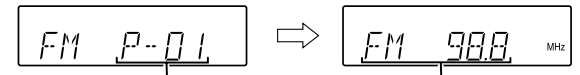

### ■ To scan the preset stations

The stations saved in memory can be scanned automatically. (Preset memory scan)

**1** Press the PRESET (∨ or ∧) button for more than 0.5 seconds.

The preset number will flash and the programmed stations will be tuned in sequentially, for 5 seconds each.

**2** Press the PRESET (∨ or ∧) button again when the desired station is located.

### ■ To clear a memorized station

- 1 Recall the memorized station.
- 2 While it is displayed, press the MEMORY/SET (MEMORY) button.
- 3 Within 5 seconds, press the CLEAR button on the remote control.

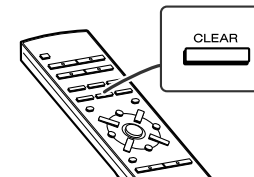



## Timer and Sleep Operation

This may be operated only with the remote control.

### Timer playback:

The unit turns on and plays the desired source (CD, tuner) at the preset time.

### Sleep operation:

The radio and compact disc can all be turned off automatically.

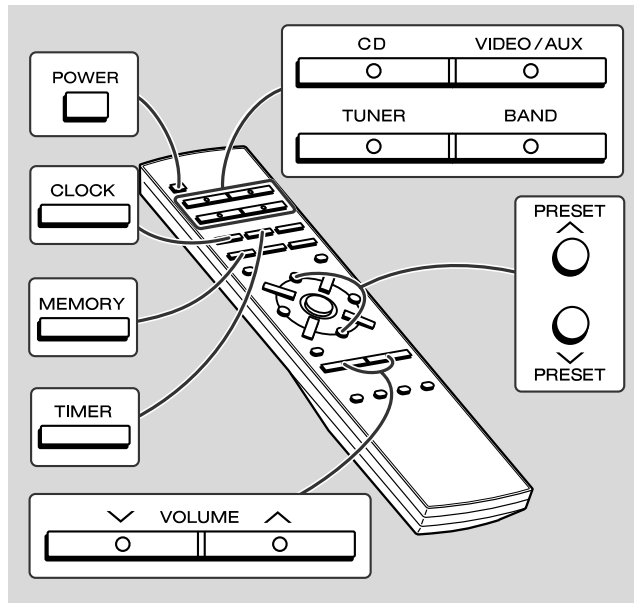

### ■ Timer playback

#### Before setting timer:

- 1 Press the CLOCK button to check that the clock is on time.



- 2 Load a disc to be played.



- 1 Press the POWER button to turn the power on.

- 2 Press the CD or TUNER button to select the desired function.

When you selected the TUNER, tune in to the desired station.

- 3 Adjust the volume using the VOLUME buttons.

Do not turn the volume up too high.

- 4 Press the TIMER button and within 6 seconds, press the MEMORY button.



- 5 Within 1 minute, press the PRESET (∨ or ∧) button to specify the hour to start, then press the MEMORY button.

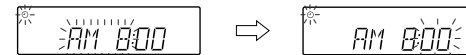

Continued to the next page

## Timer and Sleep Operation (continued)

**6** Within 1 minute, press the PRESET (∨ or ∧) button to specify the minutes to start, then press the MEMORY button.

- The timer playback starting time, function, and volume will be displayed, and then the unit will enter the stand-by mode automatically.
- "⌚" will appear and the current time will be displayed.



**To cancel the timer playback:**

Press the POWER button to turn the power on.

**7** When the preset time is reached, playback will start.

The volume will increase gradually until it reaches the volume you were listening at before your system enters the timer stand-by mode.

**8** If you select CD, the unit will enter the stand-by mode after the playback. If you select TUNER, it will enter the stand-by mode one hour after the timer playback starts.

**To reset or change the timer setting:**

Perform "Timer playback" from the beginning.

**Notes:**

- Once the time is set, the setting will be retained until a new time is entered.
- When performing timer playback using another unit connected to the VIDEO/AUX IN jacks, select "VIDEO/AUX" in step 2. At this time, only this unit will be turned on or enter the power stand-by mode automatically. It will enter the power stand-by mode 1 hour after the timer playback starts. (Another unit will not be turned on or off.)

## ■ Sleep operation

**1 Play back the desired sound source.**

**2 Press the SLEEP button.**

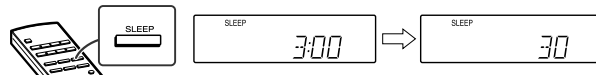

### To change the sleep time:

Press the SLEEP button repeatedly to select the desired sleep time. The time will decrease as follows.

The amount of sleep time can also be changed while in the sleep mode.

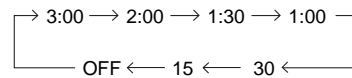

**3 Your system will enter the power stand-by mode automatically after the preset time has elapsed.**

The volume will be turned down 1 minute before the sleep operation finishes.

### To cancel the sleep operation:

Press the POWER button while the sleep timer is set.

### To confirm the remaining sleep time:

Press the SLEEP button once while the sleep timer is set. The remaining sleep time is displayed for about 3 seconds.

## ■ To use timer and sleep operation together

Example: To fall asleep and wake to the same radio station  
You can play back the same source only (the function cannot be switched).

**1 Set the sleep time (see left, steps 1 - 2).**

**2 While the sleep timer is set, set the desired playback time (steps 4 - 6, pages 25 - 26).**

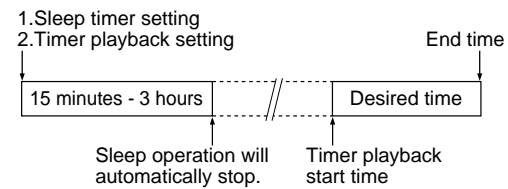

## Enhancing Your System

The connection cord is not included. Purchase a commercially available cord as shown below.

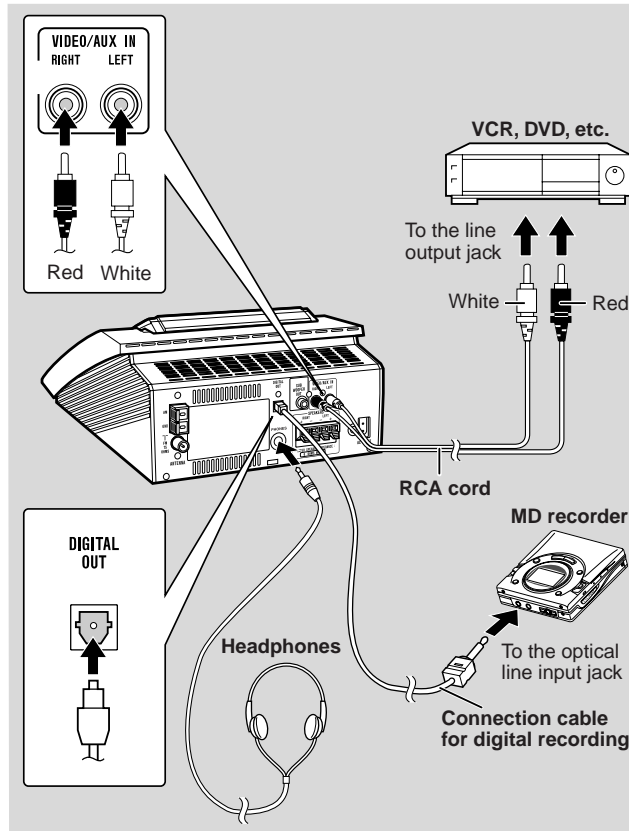

### ■ Listening to the playback sounds from VCR, DVD, etc.

- 1 Use a connection cord to connect the VCR, DVD, etc. to the VIDEO/AUX IN jacks.  
When using video equipment, connect the audio output to this unit and the video output to a television.
- 2 Press the POWER button to turn the power on.
- 3 Press the FUNCTION button until "AUX" appears on the display.  
When operating with the remote control, press the VIDEO/AUX button.
- 4 Play the VCR, DVD, etc.

#### Note:

To prevent hum interference, place this unit away from a television.

### ■ To record CD signals on MDs

The digital signal from this unit can be recorded by MiniDisc recorders, etc.

- 1 Remove the DIGITAL OUT jack cover.
- 2 Use a connection cable for digital recording to connect the unit to the OPTICAL IN jack of a MiniDisc recorder, etc.
- 3 Press the POWER button to turn the power on.
- 4 Put the MiniDisc recorder, etc. in the recording mode.
- 5 Play a CD on this unit.

#### Note:

Only CD signals can be output.

### ■ Headphones

- Before plugging in or unplugging the headphones, reduce the volume.
- Be sure your headphones have a 1/8" (3.5 mm) diameter plug and are between 16 ohms and 50 ohms impedance. The recommended impedance is 32 ohms.
- Plugging in the headphones disconnects the speakers automatically. Adjust the volume using the VOLUME buttons.

# Troubleshooting Chart

Many potential "problems" can be resolved by the owner without calling a service technician.  
If something is wrong with this product, check the following before calling your authorized SHARP dealer or service center.

## ■ General

Symptom	Possible cause
<ul style="list-style-type: none"> <li>The clock is not on time.</li> </ul>	<ul style="list-style-type: none"> <li>Did a power failure occur? Reset the clock. (Refer to page 17.)</li> </ul>
<ul style="list-style-type: none"> <li>When a button is pressed, the unit does not respond.</li> </ul>	<ul style="list-style-type: none"> <li>Set this unit to the power stand-by mode and then turn it back on.</li> <li>If the unit still malfunctions, reset it. (Refer to step 3 under "If trouble occurs" on page 30.)</li> </ul>
<ul style="list-style-type: none"> <li>No sound is heard.</li> </ul>	<ul style="list-style-type: none"> <li>Is the volume level set to "0"?</li> <li>Are the headphones connected?</li> <li>Are the speaker wires disconnected?</li> </ul>

## ■ CD player

Symptom	Possible cause
<ul style="list-style-type: none"> <li>Playback does not start.</li> </ul>	<ul style="list-style-type: none"> <li>Is the disc loaded upside-down?</li> </ul>
<ul style="list-style-type: none"> <li>Playback stops in the middle or is not performed properly.</li> </ul>	<ul style="list-style-type: none"> <li>Does the disc satisfy the standards?</li> <li>Is the disc distorted or scratched?</li> </ul>
<ul style="list-style-type: none"> <li>Playback sounds are skipped, or stopped in the middle of a track.</li> </ul>	<ul style="list-style-type: none"> <li>Is the unit located near excessive vibrations?</li> <li>Is the disc very dirty?</li> <li>Has condensation formed inside the unit?</li> </ul>

## ■ Tuner

Symptom	Possible cause
<ul style="list-style-type: none"> <li>Radio makes unusual noise consecutively.</li> </ul>	<ul style="list-style-type: none"> <li>Is the unit placed near the TV or computer?</li> <li>Is the FM/AM loop antenna placed properly? Move the AC power cord away from the antenna if located near.</li> </ul>

## ■ Remote control

Symptom	Possible cause
<ul style="list-style-type: none"> <li>The remote control does not operate.</li> </ul>	<ul style="list-style-type: none"> <li>Is the AC power cord of the unit plugged in?</li> <li>Is the battery polarity respected?</li> <li>Are the batteries dead?</li> <li>Is the distance or angle incorrect?</li> <li>Does the remote control sensor receive strong light?</li> </ul>

## Troubleshooting Chart (continued)

### ■ If trouble occurs

When this product is subjected to strong external interference (mechanical shock, excessive static electricity, abnormal supply voltage due to lightning, etc.) or if it is operated incorrectly, it may malfunction.

If such a problem occurs, do the following:

- 1 **Set the unit to the stand-by mode and turn the power on again.**
- 2 **If the unit is not restored in step 1, unplug and plug in the unit, and then turn the power on.**
- 3 **If neither step 1 nor 2 restores the unit, do the following:**
  - ① Press the POWER button to enter the power stand-by mode.
  - ② Unplug the AC power cord from the AC INPUT jack on the unit.
  - ③ While pressing down the MEMORY/SET button and the ►|| button, plug the AC power cord into the AC INPUT jack on the unit.

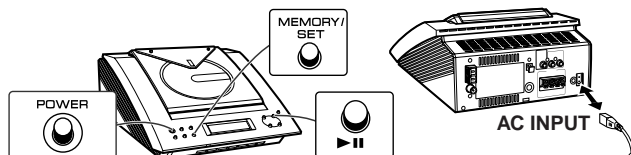

#### Caution:

This operation will erase all data stored in memory including clock, timer settings, tuner preset, and CD program.

## Maintenance

### ■ Cleaning the CD pickup lens

Do not touch the laser pickup lens. If fingerprints or dust accumulate on the pickup, clean it gently with a dry cotton swab.



### ■ Cleaning the cabinet

Periodically wipe the cabinet with a soft cloth and a diluted soap solution, then with a dry cloth.

#### Caution:

- Do not use chemicals for cleaning (gasoline, paint thinner, etc.). It may damage the cabinet finish.
- Do not apply oil to the inside of the unit. It may cause malfunctions.



# Specifications

As part of our policy of continuous improvement, SHARP reserves the right to make design and specification changes for product improvement without prior notice. The performance specification figures indicated are nominal values of production units. There may be some deviations from these values in individual units.

## ■ General

<b>Power source</b>	AC 120 V, 60 Hz
<b>Power consumption</b>	45 W
<b>Dimensions</b>	Width: 9-1/16" (230 mm) Height: 5-1/16" (128 mm) Depth: 11-9/16" (293 mm)
<b>Weight</b>	6.6 lbs. (3.0 kg)

## ■ Amplifier

<b>Output power</b>	16 watts minimum RMS per channel into 6 ohms from 100 Hz to 20 kHz, 10% total harmonic distortion
<b>Output terminals</b>	Speakers: 6 ohms Headphones: 16 - 50 ohms (recommended: 32 ohms) CD digital output (optical) Subwoofer (Audio signal): 500 mV/47 kohms
<b>Input terminals</b>	Video/Auxiliary (audio signal): 500 mV/47 kohms

## ■ CD player

<b>Type</b>	Compact disc player
<b>Signal readout</b>	Non-contact, 3-beam semiconductor laser pickup
<b>D/A converter</b>	1-bit D/A converter
<b>Frequency response</b>	20 - 20,000 Hz
<b>Dynamic range</b>	90 dB (1 kHz)

## ■ Tuner

<b>Frequency range</b>	FM: 87.5 - 108 MHz AM: 530 - 1,720 kHz
------------------------	---

## ■ Speaker

<b>Type</b>	2-way type speaker system 2" (5 cm) Tweeter 4" (10 cm) Woofer
<b>Maximum input power</b>	40 W
<b>Rated input power</b>	20 W
<b>Impedance</b>	6 ohms
<b>Dimensions</b>	Width: 5-9/16" (140 mm) Height: 11-3/8" (288 mm) Depth: 7-3/8" (187 mm)
<b>Weight</b>	4.9 lbs. (2.2 kg)/each



### CONSUMER LIMITED WARRANTY

SHARP ELECTRONICS CORPORATION warrants to the first consumer purchaser that this Sharp brand product (the "Product"), when shipped in its original container, will be free from defective workmanship and materials, and agrees that it will, at its option, either repair the defect or replace the defective Product or part thereof with a new or remanufactured equivalent at no charge to the purchaser for parts or labor for the period(s) set forth below.

This warranty does not apply to any appearance items of the Product nor to the additional excluded item(s) set forth below nor to any Product the exterior of which has been damaged or defaced, which has been subjected to improper voltage or other misuse, abnormal service or handling, or which has been altered or modified in design or construction.

In order to enforce the rights under this limited warranty, the purchaser should follow the steps set forth below and provide proof of purchase to the servicer.

The limited warranty described herein is in addition to whatever implied warranties may be granted to purchasers by law. ALL IMPLIED WARRANTIES INCLUDING THE WARRANTIES OF MERCHANTABILITY AND FITNESS FOR USE ARE LIMITED TO THE PERIOD(S) FROM THE DATE OF PURCHASE SET FORTH BELOW. Some states do not allow limitations on how long an implied warranty lasts, so the above limitation may not apply to you.

Neither the sales personnel of the seller nor any other person is authorized to make any warranties other than those described herein, or to extend the duration of any warranties beyond the time period described herein on behalf of Sharp.

The warranties described herein shall be the sole and exclusive warranties granted by Sharp and shall be the sole and exclusive remedy available to the purchaser. Correction of defects, in the manner and for the period of time described herein, shall constitute complete fulfillment of all liabilities and responsibilities of Sharp to the purchaser with respect to the Product, and shall constitute full satisfaction of all claims, whether based on contract, negligence, strict liability or otherwise. In no event shall Sharp be liable, or in any way responsible, for any damages or defects in the Product which were caused by repairs or attempted repairs performed by anyone other than an authorized servicer. Nor shall Sharp be liable or in any way responsible for any incidental or consequential economic or property damage. Some states do not allow the exclusion of incidental or consequential damages, so the above exclusion may not apply to you.

THIS WARRANTY GIVES YOU SPECIFIC LEGAL RIGHTS. YOU MAY ALSO HAVE OTHER RIGHTS WHICH VARY FROM STATE TO STATE.

**Model Specific Section**

**Your Product Model Number & Description:**

**XL-3000 Compact Audio System**

(Be sure to have this information available when you need service for your Product.)

**Warranty Period for this Product:**

One (1) year parts and labor from the date of purchase.

**Additional Item(s) Excluded from Warranty Coverage (if any):**

Non-functional accessories, supplies, and consumable items.

**Where to Obtain Service:**

At a Sharp Authorized Servicer located in the United States.

**What to do to Obtain Service:**

To find a location of the nearest Sharp Authorized Servicer, call Sharp toll free at 1-800-BE-SHARP.

Ship prepaid or carry in your Product to a Sharp Authorized Servicer.

Be sure to have **Proof of Purchase** available. If you ship the Product, be sure it is insured and packaged securely.

TO OBTAIN SUPPLY, ACCESSORY OR PRODUCT INFORMATION, CALL **1-800-BE-SHARP**.

# SHARP

**SHARP ELECTRONICS CORPORATION**

Sharp Plaza, Mahwah, New Jersey 07430-2135

TINSE0060SJZZ

**SHARP CORPORATION**

Printed in China  
C0103.HK

