

SHARP®

ENGLISH

MODEL

CD-DHS1050P

MINI COMPONENT SYSTEM

OPERATION MANUAL

CD-DHS1050P Mini Component System consisting of CD-DHS1050P (main unit), CP-S1050P (front speaker) and CP-SW1050P (subwoofer).

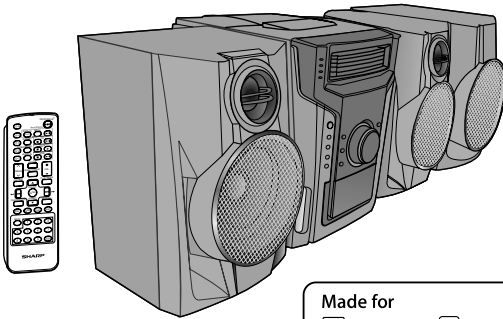

Made for



iPod



iPhone

iPhone, iPod, iPod classic, iPod nano, and iPod touch are trademarks of Apple Inc., registered in the U.S. and other countries.





MP3

COMPACT
disc
DIGITAL AUDIO

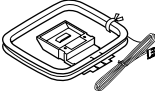
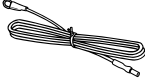

Accessories

Please confirm that only the following accessories are included.

 <p>Remote control x 1 (RRMCGA255AWSA)</p>	 <p>AM loop antenna x 1 (QANTL0005AWZZ)</p>	 <p>FM antenna x 1 (92LFANT1535A)</p>	 <p>iPhone® adaptor x 3 (GCOVAA238AWSA - No 12) (GCOVAA239AWSA - No 15) (GCOVAA294AWSA - No 19)</p>
---	--	--	--

Special Note

Supply of this product does not convey a license nor imply any right to distribute content created with this product in revenue-generating broadcast systems (terrestrial, satellite, cable and/or other distribution channels), revenue generating streaming applications (via Internet, intranets and/or other networks), other revenue-generating content distribution systems (pay-audio or audio-on-demand applications and the like) or on revenue-generating physical media (compact discs, digital versatile discs, semiconductor chips, hard drives, memory cards and the like). An independent license for such use is required. For details, please visit <http://mp3licensing.com>

MPEG Layer-3 audio coding technology licensed from Fraunhofer IIS and Thomson.

"Made for iPod" and "Made for iPhone" mean that an electronic accessory has been designed to connect specifically to iPod or iPhone, respectively, and has been certified by the developer to meet Apple performance standards. Apple is not responsible for the operation of this device or its compliance with safety and regulatory standards. Please note that the use of this accessory with iPod or iPhone may affect wireless performance.



TINSZA953AWZZ

SHARP CORPORATION

Printed in Malaysia
11C R MW ①

SPECIAL NOTES



CAUTION

RISK OF ELECTRIC SHOCK
DO NOT OPEN



CAUTION: TO REDUCE THE RISK OF ELECTRIC SHOCK, DO NOT REMOVE COVER (OR BACK). NO USER-SERVICEABLE PARTS INSIDE. REFER SERVICING TO QUALIFIED SERVICE PERSONNEL.

Explanation of Graphical Symbols:



The lightning flash with arrowhead symbol, within an equilateral triangle, is intended to alert the user to the presence of uninsulated "dangerous voltage" within the product's enclosure that may be of sufficient magnitude to constitute a risk of electric shock to persons.



The exclamation point within an equilateral triangle is intended to alert the user to the presence of important operating and maintenance (servicing) instructions in the literature accompanying the appliance.

WARNING : TO REDUCE THE RISK OF FIRE OR ELECTRIC SHOCK, DO NOT EXPOSE THIS APPLIANCE TO RAIN OR MOISTURE.

**This product is classified as a CLASS 1 LASER PRODUCT
Caution - Use of any controls, adjustments or procedures other than those specified herein may result in hazardous radiation exposure.**

Note to CATV system installer:

This reminder is provided to call the CATV system installer's attention to Article 820 of the National Electrical Code that provides guidelines for proper grounding and, in particular, specifies that the cable ground shall be connected to the grounding system of the building, as close to the point of cable entry as practical.

NOTE

This equipment has been tested and found to comply with the limits for a Class B digital device, pursuant to Part 15 of the FCC Rules. These limits are designed to provide reasonable protection against harmful interference in a residential installation. This equipment generates, uses, and can radiate radio frequency energy and, if not installed and used in accordance with the instructions, may cause harmful interference to radio communications. However, there is no guarantee that interference will not occur in a particular installation. If this equipment does cause harmful interference to radio or television reception, which can be determined by turning the equipment off and on, the user is encouraged to try to correct the interference by one or more of the following measures:

- Reorient or relocate the receiving antenna.
- Increase the separation between the equipment and receiver.
- Connect the equipment into an outlet on a circuit different from that to which the receiver is connected.
- Consult the dealer or an experienced radio/TV technician for help.

WARNING

FCC Regulations state that any unauthorized changes or modifications to this equipment not expressly approved by the manufacturer could void the user's authority to operate this equipment.

FOR YOUR RECORDS

For your assistance in reporting this unit in case of loss or theft, please record below the model number and serial number which are located on the rear of the unit. Please retain this information.

Model number
Serial number
Date of purchase
Place of purchase

IMPORTANT SAFETY INSTRUCTIONS

Electricity is used to perform many useful functions, but it can also cause personal injuries and property damage if improperly handled. This product has been engineered and manufactured with the highest priority on safety. However, improper use can result in electric shock and/or fire. In order to prevent potential danger, please observe the following instructions when installing, operating and cleaning the product. To ensure your safety and prolong the service life of this product, please read the following precautions carefully before use.

- 1) Read these instructions.
- 2) Keep these instructions.
- 3) Heed all warnings.
- 4) Follow all instructions.
- 5) Do not use this apparatus near water.
- 6) Clean only with dry cloth.
- 7) Do not block any ventilation openings. Install in accordance with the manufacturer's instructions.
- 8) Do not install near any heat sources such as radiators, heat registers, stoves, or other apparatus (including amplifiers) that produce heat.
- 9) Do not defeat the safety purpose of the polarized or grounding-type plug. A polarized plug has two blades with one wider than the other. A grounding type plug has two blades and a third grounding prong. The wide blade or the third prong are provided for your safety. If the provided plug does not fit into your outlet, consult an electrician for replacement of the obsolete outlet.
- 10) Protect the power cord from being walked on or pinched particularly at plugs, convenience receptacles, and the point where they exit from the apparatus.
 - 11) Only use attachments/accessories specified by the manufacturer.
 - 12) Use only with the cart, stand, tripod, bracket, or table specified by the manufacturer, or sold with the apparatus. When a cart is used, use caution when moving the cart/apparatus combination to avoid injury from tip-over.
- 13) Unplug this apparatus during lightning storms or when unused for long periods of time.
- 14) Refer all servicing to qualified service personnel. Servicing is required when the apparatus has been damaged in any way, such as power-supply cord or plug is damaged, liquid has been spilled or objects have fallen into the apparatus, the apparatus has been exposed to rain or moisture, does not operate normally, or has been dropped.



IMPORTANT SAFETY INSTRUCTIONS (continued)

Additional Safety Information

- 15) Power Sources - This product should be operated only from the type of power source indicated on the marking label. If you are not sure of the type of power supply to your home, consult your product dealer or local power company. For product intended to operate from battery power, or other sources, refer to the operating instructions.
- 16) Overloading - Do not overload wall outlets, extension cords, or integral convenience receptacles as this can result in a risk of fire or electric shock.
- 17) Object and Liquid Entry - Never push objects of any kind into this product through openings as they may touch dangerous voltage points or short-out parts that could result in a fire or electric shock. Never spill liquid of any kind on the product.
- 18) Damage Requiring Service - Unplug this product from the wall outlet and refer servicing to qualified service personnel under the following conditions:
 - a) When the AC cord or plug is damaged,
 - b) If liquid has been spilled, or objects have fallen into the product,
 - c) If the product has been exposed to rain or water,
 - d) If the product does not operate normally by following the operating instructions. Adjust only those controls that are covered by the operating instructions as an improper adjustment of other controls may result in damage and will often require extensive work by a qualified technician to restore the product to its normal operation,
 - e) If the product has been dropped or damaged in any way, and
 - f) When the product exhibits a distinct change in performance - this indicates a need for service.
- 19) Replacement Parts - When replacement parts are required, be sure the service technician has used replacement parts specified by the manufacturer or have the same characteristics as the original part. Unauthorized substitutions may result in fire, electric shock, or other hazards.
- 20) Safety Check - Upon completion of any service or repairs to this product, ask the service technician to perform safety checks to determine that the product is in proper operating condition.
- 21) Wall or ceiling mounting - When mounting the product on a wall or ceiling, be sure to install the product according to the method recommended by the manufacturer.
- 22) Power Lines - An outside antenna system should not be located in the vicinity of overhead power lines or other electric light or power circuits, or where it can fall into such power lines or circuits. When installing an outside antenna system, extreme care should be taken to keep from touching such power lines or circuits as contact with them might be fatal.
- 23) Protective Attachment Plug - The product is equipped with an attachment plug having overload protection. This is a safety feature. See Instruction Manual for replacement or resetting of protective device. If replacement of the plug is required, be sure the service technician has used a replacement plug specified by the manufacturer that has the same overload protection as the original plug.

- 24) Stand - Do not place the product on an unstable cart, stand, tripod or table. Placing the product on an unstable base can cause the product to fall, resulting in serious personal injuries as well as damage to the product. Use only a cart, stand, tripod, bracket or table recommended by the manufacturer or sold with the product. When mounting the product on a wall, be sure to follow the manufacturer's instructions. Use only the mounting hardware recommended by the manufacturer.

Precautions

■ General

- Please ensure that the equipment is positioned in a well ventilated area and ensure that there is at least 4" (10 cm) of free space along the sides, top and back of the equipment.

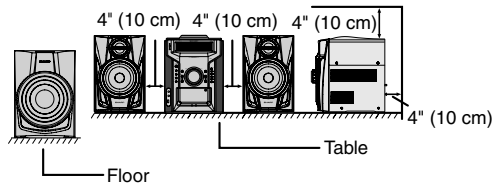

- Do not place subwoofer system on the same surface as the main unit to prevent sound interruption during playback.
- The unit will start the tape initialization when plugged in to the AC outlet. During this process, initializing sound will be heard and the unit cannot be turned on. Wait until the process is finished.
- Use the unit on a firm, level surface free from vibration.
- Place the speakers at least 12" (30 cm) away from any CRT TV to avoid color variations across the TV screen. If the variations persist, move the speakers further away from the TV. LCD TV is not prone to such variation.
- Keep the unit away from direct sunlight, strong magnetic fields, excessive dust, humidity and electronic/electrical equipment (home computers, facsimiles, etc.) which generate electrical noise.
- Do not place anything on top of the unit.
- Do not expose the unit to moisture, to temperatures higher than 140°F (60°C) or to extremely low temperatures.
- If your system does not work properly, disconnect the AC power cord from the AC outlet. Plug the AC power cord back in, and then turn on your system.
- In case of an electrical storm, unplug the unit for safety.
- Hold the AC power plug by the head when removing it from the AC outlet, as pulling the cord can damage internal wires.
- The AC power plug is used as a disconnect device and shall always remain readily operable.
- Do not remove the outer cover, as this may result in electric shock. Refer internal service to your local SHARP service facility.
- This unit should only be used within the range of 41°F - 95°F (5°C - 35°C).

CONSUMER LIMITED WARRANTY

SHARP ELECTRONICS CORPORATION warrants to the first consumer purchaser that this Sharp brand product (the "Product"), when ship in its original container, will be free from defective workmanship and materials, and agrees that it will, at its option, either repair the defect or replace the defective Product or part thereof with a new or remanufactured equivalent at no charge to the purchaser for parts or labor for the period(s) set forth below.

This warranty does not apply to any appearance items of the Product nor to the additional excluded item(s) set forth below nor to any Product the exterior of which has been damaged or defaced, which has been subjected to improper voltage or other misuse, abnormal service or handling, or which has been altered or modified in design or construction.

In order to enforce the rights under this limited warranty, the purchaser should follow the steps set forth below and provide proof of purchase to the servicer.

The limited warranty described herein is in addition to whatever implied warranties may be granted to purchasers by law. ALL IMPLIED WARRANTIES INCLUDING THE WARRANTIES OF MERCHANTABILITY AND FITNESS FOR USE ARE LIMITED TO THE PERIOD(S) FROM THE DATE OF PURCHASE SET FORTH BELOW. Some states do not allow limitations on how long an implied warranty lasts, so the above limitation may not apply to you.

Neither the sales personnel of the seller nor any other person is authorized to make any warranties other than those described herein, or to extend the duration of any warranties beyond the time period described herein on behalf of Sharp.

The warranties described herein shall be the sole and exclusive warranties granted by Sharp and shall be the sole and exclusive remedy available to the purchaser. Correction of defects, in the manner and for the period of time described herein, shall constitute complete fulfillment of all liabilities and responsibilities of Sharp to the purchaser with respect to the Product, and shall constitute full satisfaction of all claims, whether based on contract, negligence, strict liability or otherwise. In no event shall Sharp be liable, or in any way responsible, for any damages or defects in the Product which were caused by repairs or attempted repairs performed by anyone other than an authorized servicer. Nor shall Sharp be liable or in any way responsible for any incidental or consequential economic or property damage. Some states do not allow the exclusion of incidental or consequential damages, so the above exclusion may not apply to you.

THIS WARRANTY GIVES YOU SPECIFIC LEGAL RIGHTS. YOU MAY ALSO HAVE OTHER RIGHTS WHICH VARY FROM STATE TO STATE.

Model Specific Section

Your Product Model Number & Description:

CD-DHS1050P Mini Component System

(Be sure to have this information available when you need service for your Product.)

Warranty Period for this Product:

One (1) year parts and labor from the date of purchase.

Additional Item(s) Excluded from Warranty Coverage (if any):

Non-functional accessories, supplies, and consumable items.

Where to Obtain Service:

At a Sharp Authorized Servicer located in the United States. To find a location of the nearest Sharp Authorized Servicer, call Sharp toll free at 1-800-BE-SHARP.

What to do to Obtain Service:

Ship prepaid or carry in your Product to a Sharp Authorized Servicer. Be sure to have **Proof of Purchase** available. If you ship the Product, be sure it is insured and packaged securely.

TO OBTAIN SUPPLY, ACCESSORY OR PRODUCT INFORMATION, CALL **1-800-BE-SHARP**

SHARP ELECTRONICS CORPORATION

Sharp Plaza, Mahwah, New Jersey 07495-1163

Precautions (continued)

Warning:

The voltage used must be the same as that specified on this unit. Using this product with a higher voltage other than that which is specified is dangerous and may result in a fire or other type of accident causing damage. SHARP will not be held responsible for any damage resulting from use of this unit with a voltage other than that which is specified.

■ Volume control

The sound level at a given volume setting depends on speaker efficiency, location and various other factors. It is advisable to avoid exposure to high volume levels, which occurs while turning the unit on with the volume control setting up high, or while continually listening at high volumes. Excessive sound pressure from earphones and headphones can cause hearing loss.

System connection

■ Speaker connection

- If you use other speakers with an impedance lower than that specified, the unit may be damaged. Front speakers: 6 ohms, Subwoofer: 4 ohms.
- Do not make a mistake when connecting the right and left speakers. The right speaker is the one on the right side when you face the unit.
- Never mistake the FRONT SPEAKERS and the SUBWOOFER terminals. The unit or the speakers may be damaged.
- Insert the speaker plug fully with the lever side facing to the top.
- Hold the speaker plug when removing it from the unit. Pulling the wire may cause malfunction to the unit.
- Do not stand or sit on the speakers. You may be injured.
- Do not allow any objects to fall into or to be placed in the bass reflex duct.

System connections (continued)

Make sure to unplug the AC power cord before making any connections.

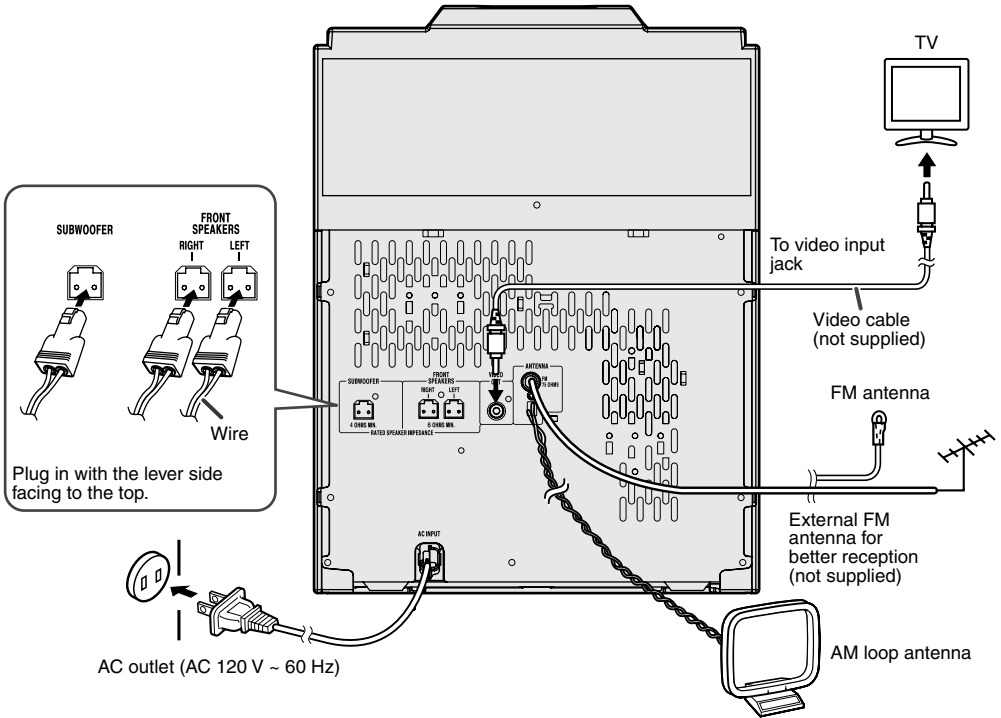

Remote control

■ Battery installation

Use 1 "AA" size battery (UM/SUM-3, R6, HP-7 or similar). Battery is not included.

- 1 Open the battery cover.
- 2 Insert the battery according to the direction indicated in the battery compartment. When inserting or removing the battery, push it toward the ⊖ battery terminal.
- 3 Close the battery cover.

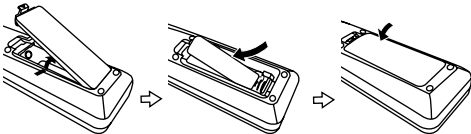

Caution:

- Remove the battery if the unit will not be used for a long period of time. This will prevent potential damage due to battery leakage.
- Do not use rechargeable batteries (nickel-cadmium battery, etc.).
- Installing the battery incorrectly may cause the unit to malfunction.
- Batteries (battery pack or batteries installed) shall not be exposed to excessive heat such as sunshine, fire or the like.

Notes concerning use:

- Replace the battery if the operating distance is reduced or if the operation becomes erratic.
- Periodically clean the transmitter on the remote control and the sensor on the unit with a soft cloth.
- Exposing the sensor on the unit to strong light may interfere with operation. Change the lighting or the direction of the unit.
- Keep the remote control away from moisture, heat, shock, and vibrations.

General control

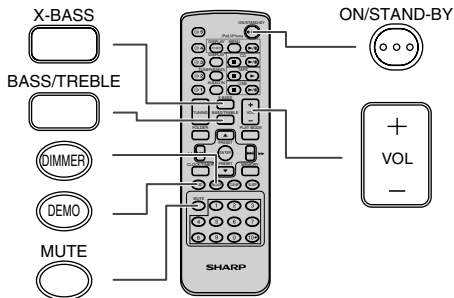
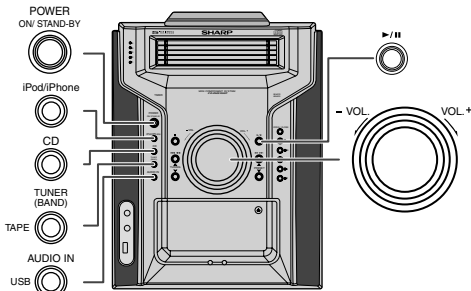

■ To turn the power on

The first time the unit is plugged in, the unit will enter the demonstration mode.

Function	Main unit	Remote control	Operation
Power on/off	POWER ON/STAND-BY 	ON/STAND-BY 	Press to turn the power on or to go to stand-by mode.
Demo on/off		DEMO 	Press to enter to demonstration on or off mode.

■ Display brightness control

To dim the display brightness, press the DIMMER button on the remote control.

■ Volume auto fade-in

If you turn off and on the main unit with the volume set to 27 or higher, the volume starts at 16 and fades in to the last set level.

■ Volume control

Turn the volume knob toward VOL +/- (on main unit) or press VOL +/- (on remote control) to increase or decrease the volume.

■ Bass control (X-BASS)

When the power is first turned on, the unit will enter the extra bass mode which emphasizes the bass frequencies, and "X-BASS" will appear. To cancel the extra bass mode, press the X-BASS button.

■ Bass control

- 1 Press the BASS/TREBLE button to select "BASS".
- 2 Within 5 seconds, press the VOLUME (+ or -) button to adjust the bass.

■ Treble control

- 1 Press the BASS/TREBLE button to select "TREBLE".
- 2 Within 5 seconds, press the VOLUME (+ or -) button to adjust the treble.

■ Auto power on function

When you press any of the following buttons, the unit turns on.

- iPod®/iPhone, CD, USB, AUDIO IN, TUNER (BAND), TAPE button (main unit/remote control): Selected function is activated.
- ►/|| button (main unit): The unit turns on and playback of the last function will start (iPod/iPhone, CD, USB, AUDIO IN, TUNER (BAND), TAPE).
- iPod/iPhone ►/|| button (remote control): The unit turns on and the iPod/iPhone playback starts (regardless of the last function).
- CD ►/|| button (remote control): The unit turns on and the CD playback starts (regardless of the last function).
- TAPE ► button (remote control): The unit turns on and the TAPE playback starts (regardless of the last function).
- USB ►/|| button (remote control): The unit turns on and the USB playback starts (regardless of the last function).

■ Auto power off function

The main unit will enter the stand-by mode (when iPod/iPhone is not docked) after 15 minutes of inactivity during:
iPod/iPhone: No connection.

AUDIO IN: No detection of input signal or very low sound audibility.

TUNER: No reception of broadcast signal.

CD / USB / TAPE: In the stop mode.

Note:

However, if iPod/iPhone is docked, the unit will begin charging.

"CHARGING" will be displayed.

Listening to the iPod or iPhone

iPhone and iPod operations

Made for:

- iPhone 4
- iPhone 3GS
- iPhone 3G
- iPhone
- iPod touch (4th generation)
- iPod touch (3rd generation)
- iPod touch (2nd generation)
- iPod touch (1st generation)
- iPod classic
- iPod nano (6th generation)
- iPod nano (5th generation)
- iPod nano (4th generation)
- iPod nano (3rd generation)
- iPod nano (2nd generation)

Caution:

Please update your iPod unit to the latest software version from Apple's homepage before using it.

Notes:

- Once the iPod or iPhone is connected to the unit it will begin charging.
- The iPod or iPhone unit cannot be charged during USB mode.
- The message "This accessory is not made to work with iPhone" or similar, may appear on the iPhone screen when:
 - battery is low.
 - the iPhone is not properly docked (eg. slanting).
 If this occurs, remove and re-dock the iPhone.
- This product is made for iPhone. To prevent random interference when iPhone is docked, the headphone output is disabled, and "HP INVALID" will be displayed. You may also experience brief audio interference during incoming calls.

■ iPod and iPhone adaptor connection

Notes:

- Please use the adaptor supplied with your iPod or iPhone unit.
- You can use an audio cable to connect your iPod to the AUDIO IN jack if:
 1. your iPod adaptor does not fit into the iPod dock on the main unit.
 2. you have an iPod that does not have an iPod adaptor.
 3. you have an iPod that does not have an iPod 30 pin connector.

iPhone Adaptor No.	iPhone Description	Capacity
12	iPhone	4GB & 8GB & 16GB
15	iPhone 3G	8GB & 16GB
15	iPhone 3GS	16GB & 32GB
19	iPhone 4	16GB & 32GB

■ To insert iPod or iPhone adaptor

Insert the iPod or iPhone adaptor into the unit and connect your iPod or iPhone.

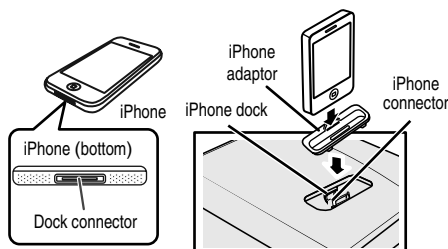

■ To remove iPod or iPhone adaptor

Insert the tip of a screwdriver ("+" type, small) into the adaptor hole as shown and lift upward to remove.



■ iPod or iPhone playback

- 1 Press the ON/STAND-BY button to turn the power on.
- 2 Press the iPod/iPhone button to select iPod or iPhone function.
- 3 Insert iPod or iPhone unit in iPod or iPhone dock of main unit. "DOCK OK" will be displayed.
- 4 Press the ►/⏸ (iPod or iPhone ►/⏸) button to start playback.

Note:

iPod and iPhone cannot be played back via USB cable and connection, "NO SUPPORT" will be displayed.

■ iPhone playback

- Sound will only switch from iPhone to the main unit after authentication process is completed in approximately 10 seconds.
- Incoming calls will pause the playback.
- Once the calls are answered, the conversation can only be heard through the built-in iPhone speaker. Turn on the iPhone speaker or undock the iPhone to start conversation.

■ To disconnect iPod or iPhone

Simply remove the iPod or iPhone from the iPod or iPhone dock. It is safe to do so even during playback.

■ Navigating the iPod or iPhone menus

- 1 Press the MENU button to view the menu on iPod or iPhone unit. Press it again to go back to previous menu.
- 2 Use the PRESET (▼ or ▲) button to select an item on the menu and then press ENTER button.

Note:

When navigating the iPod or iPhone menu with remote control, do not operate any of the buttons on the iPod or iPhone unit. The volume level is adjusted by turning the volume knob on main unit or pressing the VOL (+ or -) button on the remote control. Adjusting the volume on the iPod unit gives no effect.

iPod or iPhone operation

The operations described below depend on the generation iPod or iPhone you are using.

System on operation

When the main unit is powered on, the iPod or iPhone unit will automatically power on when docked in the unit (including TIMER function).

System off (stand-by operation)

When the main unit is turned to stand-by mode, the docked iPod or iPhone unit will automatically turn to stand-by mode.

Listening to the iPod or iPhone (continued)

■ Various iPod or iPhone functions

Function	Main unit	Remote control	Operation
Play			Press in the pause mode.
Pause			Press in the playback mode.
Track up/down			Press in the playback or pause mode. If you press the button in the pause mode, press the ►/ button to start the desired track.
Fast forward/reverse			Press and hold down in the playback mode. Release the button to resume playback.
Back light/TV OUT	—	DISPLAY 	iPod back light ON. Press and hold this button for more than 2 seconds until "TV OUT ON" or "TV OUT OFF" appear to toggle the video out display between iPod or TV.
Repeat	—	PLAY MODE	Press to toggle repeat mode.
Shuffle	—		Press and hold down to toggle shuffle mode.
Menu	—	MENU	Press to view the iPod menu during iPod function.
Enter	—	ENTER	Press to confirm the selection.
Cursor Up/Down	—	PRESET PRESET 	Press to select the iPod menu.

■ Watching videos on a TV connected to iPod or iPhone

- Press and hold the DISPLAY button for more than 2 seconds until "TV OUT ON" appear on display.
- Press the ENTER button to start playback.

Notes:

- If the TV Out setting is already turned On at video menu, the video is automatically displayed on the TV screen when ENTER key is pressed.
- To return to watching video on iPod or iPhone screen, press the MENU button to enter video menu. Then press and hold the DISPLAY button for more than 2 seconds until "TV OUT OFF" appears.
- During iPod or iPhone video playback, pressing the DISPLAY button will not toggle video out display between iPod or iPhone and TV.

Caution:

- Unplug all accessories for the iPod or iPhone before inserting it into the iPod or iPhone dock.
- Stop button (■) at main unit is invalid during iPod or iPhone function.

Listening to a CD or MP3/WMA disc

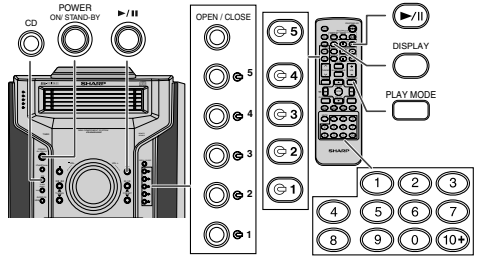

■ Disc playback

- Press the ON/STAND-BY button to turn the power on.
- Press the CD button.
- Press the button and within 5 seconds, press the OPEN/CLOSE button to open the disc tray 1.
- Place the disc on the disc tray 1, label side up.
- Press OPEN/CLOSE button to close the disc tray 1.
- You can place discs on the trays 2 - 5 by following steps 3 - 5.
- Press the ►/|| button to start playback.

Notes for CD or MP3/WMA discs:

- Track up/track down is possible only within individual discs.
- When the beginning of the first track is reached during fast reverse, the unit will enter the playback mode.
- Rewritable multi-session discs with unfinished writing, can still be played.

■ Various disc functions

Function	Main unit	Remote control	Operation
Pause			Press in the playback mode. Press the ►/ button to resume playback from the paused point.
Track up/Track down			Press in the playback or stop mode. If you press the button in the stop mode, press the ►/ button to start the desired track.
Fast forward/Fast reverse			Press and hold down in the playback mode. Release the button to resume playback.

■ To specify a disc to play

You can play a disc by specifying the disc number.

- Press one of the buttons to select the desired disc.

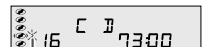

Selected disc number

- Within 5 seconds, press the ►/|| (CD ►/||) button.

- Playback will begin from track 1 on the chosen disc.
- After the last track on the last disc is played, the unit stops automatically.

Listening to a CD or MP3/WMA disc (continued)

Note:

If a disc tray with no disc is selected, playback will not start and the disc indicator will disappear.

To stop playback: Press the **■** (CD **■**) button.

■ Direct track search

By using the numeric buttons, the desired tracks on the current disc can be played.

Use the numeric buttons on the remote control to select the desired track while playing the selected disc.

- The numeric buttons allow you to select up to number 9.
- When selecting number 10 or higher, use the "+10" button.

A. For example, to choose 13

- 1 Press the "+10" button.
- 2 Press the "1" and then "3" button.

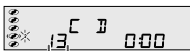

Selected track number

B. For example, to choose 130

- 1 Press the "+10" button twice.
- 2 Press the "1", "3" and "0" button.

Notes:

- A track number higher than the number of tracks on the disc cannot be selected.
- During random play, direct search is not possible.

■ Repeat play

Repeat play can play all 5 discs, all tracks on a chosen disc, single track on a chosen disc, or a programmed sequence continuously.

To repeat one track:

Press the PLAY MODE button once. Press the **▶/||** button.

To repeat one disc:

Press the PLAY MODE button twice. Press the **▶/||** (CD **▶/||**) button.

To repeat all tracks on up to 5 discs:

Press the PLAY MODE button 3 times. Press the **▶/||** (CD **▶/||**) button.

To repeat desired tracks:

Perform steps 1 - 6 in "Programmed play" section on page 8 and then press the PLAY MODE button.

To cancel repeat play:

Press the PLAY MODE button again until "C" disappears.

■ Random play

The tracks on the disc(s) can be played in random order automatically.

To random play all tracks on up to 5 discs:

Press the PLAY MODE button for 2 seconds on the remote control and then press the **▶/||** (CD **▶/||**) button.

To cancel random play:

Press the PLAY MODE button. "R" will disappear.

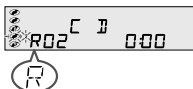

Notes:

- If you press the **▶▶** button during random play, you can move to the next track by the random operation. On the other hand, the **◀◀** button does not allow you to move to the previous track. The beginning of the track being played will be located.
- In random play, the unit will select and play tracks automatically. (You cannot select the order of the tracks.)

Caution:

After performing repeat or random play, be sure to press the **■** (CD **■**) button. Otherwise, the disc(s) will play continuously.

■ Programmed play

You can choose up to 32 selections for playback in the order you like.

- 1 While in the stop mode, press the MEMORY button to enter the programming save mode.
- 2 Press one of the **⊖** 1 - **⊕** 5 buttons to select the desired disc.
- 3 Press the numeric buttons on the remote control or **◀◀** or **▶▶** button to select the desired track.
- 4 Press the MEMORY button to save the track number.
- 5 Repeat steps 2 - 4 for other tracks. Up to 32 tracks can be programmed. If you want to check the programmed tracks, press the MEMORY button repeatedly. If you make a mistake, the programmed tracks can be cleared by pressing the CLEAR button.
- 6 Press the **▶/||** (CD **▶/||**) button to start playback.



■ Programmed play (MP3/WMA)

- 1 While in the stop mode, press the MEMORY button to enter the programming save mode.
- 2 Press one of the **⊖** 1 - **⊕** 5 buttons to select the desired disc.
- 3 Press the PRESET (**▼** or **▲**) button on the remote control to select the desired folder. Then press the **◀◀** or **▶▶** button on the remote control to select the desired tracks.
- 4 Press the MEMORY button to save the folder and track number.
- 5 Repeat steps 3 - 4 for other folder/tracks. Up to 32 tracks can be programmed.
- 6 Press the **▶/||** (CD/USB **▶/||**) button to start playback.



To cancel the programmed play mode:

During programmed stop mode, press the **■** (CD **■**) button. The display will show "MEM CLEAR" and all the programmed contents will be cleared.

Adding tracks to the program:

If a program has been previously stored, the "MEMORY" indicator will be displayed.

Press the MEMORY button. Then follow steps 3 - 4 to add tracks.

Notes:

- When a disc is ejected, the program is automatically canceled.
- If you press the ON/STAND-BY button to enter the stand-by mode or change the function from CD to another, the programmed selections will be cleared.
- During the program operation, random play is not possible.
- Do not mix CD with MP3/WMA discs during programming.

Listening to USB mass storage device/MP3 player

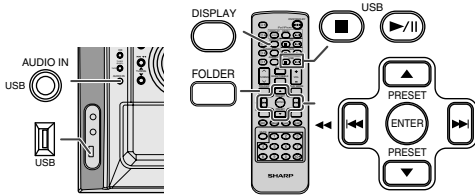

Note:

This product is not compatible with MTP and AAC file systems from USB mass storage device or MP3 player.

■ To play back USB/MP3 player with folder mode off

- 1 Press the USB button on main unit to select USB function. Connect the USB memory device that has MP3/WMA format files on the unit. When the USB memory is connected to the main unit, the device information will be displayed.
- 2 Select desired file to be played back by pressing the ◀◀ or ▶▶ button.
- 3 Press the ▶/|| (USB ▶/||) button. Playback will start and the file name will be displayed.
 - Title, Artist and Album name are displayed if they are recorded in the USB memory device.
 - Display content can be changed by pressing the DISPLAY button.

Note:

To pause playback:
Press the ▶/|| (USB ▶/||) button.

■ To play back USB/MP3 player with folder mode on

- 1 Press the USB button on main unit to select USB function. Connect the USB memory device that has MP3/WMA format files on the unit. When the USB memory is connected to the main unit, the device information will be displayed.
- 2 Press the FOLDER button, and press the PRESET (▼ or ▲) button to select desired playback folder. To start playback with folder mode on, go to step 4.
- 3 Select desired file to be played back by pressing the ◀◀ or ▶▶ button.
- 4 Press the ▶/|| (USB ▶/||) button. Playback will start and the file name will be displayed.
 - Title, Artist and Album name are displayed if they are recorded in the USB memory device.
 - Display content can be changed by pressing the DISPLAY button.

■ To remove USB memory device

- 1 Press the ■ (USB ■) button to stop playback.
- 2 Disconnect USB memory device from the USB terminal.

Notes:

- SHARP will not be held liable for the loss of data while the USB memory device is connected to the audio system.
- Files compressed in MP3 and/or WMA format can be played back when connected to the USB terminal.
- This USB memory's format supports FAT 16 or FAT 32.
- SHARP cannot guarantee that all USB memory devices will work on this audio system.
- USB cable is not recommended for use in this audio system to connect to USB memory device. Use of the USB cable will affect the performance of this audio system.

- This USB memory cannot be operated via USB hub.
- The USB terminal in this unit is not intended for a PC connection but is used for music streaming with a USB memory device.
- External HDD-storage cannot be played back via USB terminal.
- If the data inside the USB memory is large, it may take longer time for the data to be read.
- This product can play WMA and MP3 files. It will automatically detect the file type being played. If unplayable file is played on this product, "NO SUPPORT" is indicated and the file will be automatically skipped. This will take a few seconds. If abnormal indications appear on the display due to the unspecified file, turn off the unit and then turn it on again.
- This product relates to USB mass storage devices and MP3 players. It may however face some irregularities due to various unforeseen reasons from some devices. Should this happen, turn off the unit and then turn it on again.
- The USB port is only intended for direct connection to a USB memory device without any cable.
- During CD function, MP3 player will not be charging.

Advanced USB playback

The following functions are the same as CD operations:

	Page
Direct track search	8
Repeat play	8
Random play	8
Programmed play (MP3/WMA).....	8

Note:

If USB memory device is not connected, "NO MEDIA" will be shown on the display.

Notes:

- This unit only supports "MPEG-1 Audio Layer-3" format. (Sampling Frequency is 32, 44.1, 48kHz)
- Playback order for MP3 files may differ depending on the writing software used during file download.
- Bitrate which is supported by MP3 is 32-320 kbps, WMA is 64-160 kbps.
- For MP3/WMA files, please put ".MP3" ".WMA" extension. Files cannot be played back if there is no MP3/WMA extension.
- Playlists are not supported on this unit.
- This unit can display Folder Name or File Name up to 32 characters.
- Maximum total number of MP3/WMA files is 65025.
- Total number of folders read is 999 including folder with non playable file. However, the display shows only folder with MP3 files.
- The display playback time may not be displayed correctly when playing back a variable bitrate file.
- The ID3TAG information supported are TITLE, ARTIST and ALBUM only. Title name, artist name and album name can be displayed by pressing the DISPLAY button during file playback or pause mode.
- WMA meta tag also supports title, artist and album name which are recorded in WMA files. Copyright protected WMA files cannot be played back.

Listening to the radio

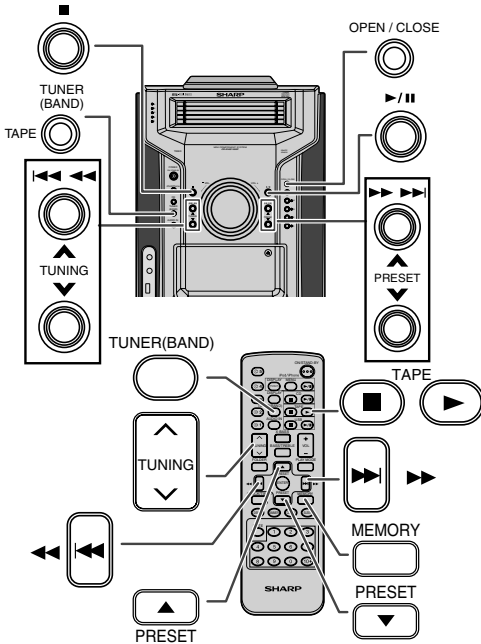

■ Tuning

- 1 Press the ON/STAND-BY button to turn the power on.
- 2 Press the TUNER (BAND) button repeatedly to select the desired frequency band (FM or AM).
- 3 Press the TUNING (∨ or ∧) button to tune in to the desired station.

Manual tuning:

Press the TUNING (∨ or ∧) button as many times as required to tune in to the desired station.

Auto tuning:

When the TUNING (∨ or ∧) button is pressed for more than 0.5 seconds, scanning will start automatically and the tuner will stop at the first receivable broadcast station.

Notes:

- When radio interference occurs, auto scan tuning may stop automatically at that point.
- Auto scan tuning will skip weak signal stations.
- To stop the auto tuning, press the TUNING (∨ or ∧) button again.

To receive an FM stereo transmission:

- Press the TUNER (BAND) button to display the "ST" indicator.
- "CD" will appear when an FM broadcast is in stereo.
- If the FM reception is weak, press the TUNER (BAND) button to extinguish the "ST" indicator. The reception changes to monaural, and the sound becomes clearer.

■ Memorizing a station

You can store 40 AM and FM stations in memory and recall them at the push of a button. (Preset tuning)

- 1 Perform steps 1 - 3 in "Tuning".
- 2 Press the MEMORY button to enter the preset tuning saving mode. 
- 3 Within 30 seconds, press the PRESET (∨ or ∧) button to select the preset channel number. Store the stations in memory, in order, starting with preset channel 1.
- 4 Within 30 seconds, press the MEMORY button to store that station in memory. If the "MEMORY" and preset number indicators disappear before the station is memorized, repeat the operation from step 2.
- 5 Repeat steps 1 - 4 to set other stations, or to change a preset station. When a new station is stored in the memory, the station previously memorized for that preset channel number will be erased.

Note:

The backup function protects the memorized stations for a few hours should there be a power failure or the AC power cord become disconnected.

■ To recall a memorized station

Press the PRESET (∨ or ∧) button for less than 0.5 seconds to select the desired station.

■ To scan the preset stations

The stations saved in the memory can be scanned automatically. (Preset memory scan)

- 1 Press the PRESET (∨ or ∧) button for more than 0.5 seconds. The preset number will flash and the programmed stations will be tuned in sequentially, for 5 seconds each.
- 2 Press the PRESET (∨ or ∧) button again when the desired station is located.

■ To erase entire preset memory

- 1 Press the ON/STAND-BY button to enter the stand-by mode.
- 2 While pressing down the OPEN / CLOSE button and TUNING ∨ button, press the TUNER (BAND) button until "TUNER CLEAR" appears.



Listening to a cassette tape

Before playback:

- For playback, use normal or low-noise tapes for the best sound. (Metal or CrO₂ tapes are not recommended.)
- Do not use C-120 tapes or poor-quality tapes, as they may cause malfunctions.
- Before loading a tape into the cassette compartment, tighten the slack with a pen or a pencil.



■ Tape playback

- 1 Press the ON/STAND-BY button to turn the power on.
- 2 Open the cassette compartment by pushing the area marked "▲".
- 3 Load a cassette into the TAPE compartment with the side to be played facing toward you.
- 4 Press the TAPE / TUNER button repeatedly to select TAPE.
- 5 Press the ►/|| (TAPE ►) button to start playback.

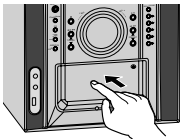

■ Various tape functions

Function	Main unit	Remote control	Operation
Stop			Press in the playback, fast forward or fast rewind mode.
Fast forward/rewind			Press in the playback or stop mode.

Caution:

- Before remove the cassette or changing from one tape operation to another, press the ■ (TAPE ■) button.
- If a power failure occurs during tape operation, the tape head will remain engaged with the tape and the cassette door will not open. In this case, wait until the power is restored.

■ Cleaning the tape-handling parts

- Dirty heads, capstans or pinch rollers can cause poor sound and tape jams. Clean these parts with a cotton swab moistened with commercial head/pinch roller cleaner or isopropyl alcohol.
- When cleaning the heads, pinch rollers, etc., unplug the unit which contains high voltages.

- (A) Playback head
- (B) Capstan
- (C) Pinch roller

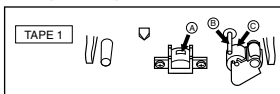

- After long use, the deck's heads and capstans may become magnetized, causing poor sound. Demagnetize these parts once every 30 hours of playing/recording time by using a commercial tape head demagnetizer. Read the demagnetizer's instructions carefully before use.

Setting the clock (Remote control only)

In this example, the clock is set for the 12-hour (AM 12:00) display.

- 1 Press the ON/STAND-BY button to turn the power on.
- 2 Press the CLOCK/TIMER button.
- 3 Within 10 seconds, press the MEMORY button.
- 4 Press the ◀◀◀ or ▶▶▶ button to select 12-hour or 24-hour display and then press the MEMORY button.

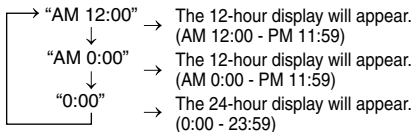

- 5 Press the ◀◀◀ or ▶▶▶ button to adjust the hour and then press the MEMORY button.
- 6 Press the ◀◀◀ or ▶▶▶ button to adjust the minutes and then press the MEMORY button. Press the ◀◀◀ or ▶▶▶ button once to advance the time by 1 minute. Hold it down to change the time in 5-minutes intervals.

To confirm the time display:

Press the CLOCK/TIMER button. The time display will appear for about 10 seconds.

Note:

The "CLOCK" will appear or time will flash to confirm the time display when the AC power supply is restored after a power failure or unplugging the unit. If incorrect, readjust the clock as follows.

To readjust the clock:

Perform "Setting the clock" from step 1. If "CLOCK" does not appear in step 3, step 4 (for selecting the 12-hour or 24-hour display) will be skipped.

To change the 12-hour or 24-hour display:

- 1 Clear all the programmed contents. [Refer to "Factory reset, clearing all memory" on page 14 for details.]
- 2 Perform "Setting the clock" from step 1 onwards.

Timer and sleep operation (Remote control only)

Once timer:

Once timer play works for one time only at a preset time.

Daily timer:

Daily timer play works at the same preset time every day. For example, set the timer as a wake-up call every morning.

Using the once timer and daily timer in combination:

For example, use the once timer to listen to a radio program, and use the daily timer to wake up.

Timer and sleep operation (Remote control only) (continued)

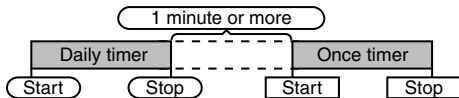

■ Timer playback

Before setting timer:

- 1 Check that the clock is set to the correct time. If it is not set, you cannot use the timer function.
- 2 For timer playback: Plug in USB, dock iPod/iPhone, load discs or tape to be played.



- 1 Press the ON/STAND-BY button to turn the power on.
- 2 Press and hold the CLOCK/TIMER button.
- 3 Within 10 seconds, press the ◀◀ ◀◀ or ▶▶ ▶▶ button to select "ONCE" or "DAILY", and press the MEMORY button. Set the clock to the correct time if "ONCE" or "DAILY" does not appear.
- 4 Within 10 seconds, press the ◀◀ or ▶▶ button to select "ONCE SET" or "DAILY SET", and press the MEMORY button.
- 5 To adjust the hour, press the ◀◀ or ▶▶ button and then press the MEMORY button.
- 6 To adjust the minutes, press the ◀◀ or ▶▶ button and then press the MEMORY button.
- 7 Set the time to finish as in steps 5 and 6 above.
- 8 To select the timer playback source (CD, TUNER, USB, iPod/iPod, TAPE or AUDIO IN), press the ◀◀ or ▶▶ button. Press the MEMORY button. When you select the tuner, select a station by pressing the ◀◀ or ▶▶ button, and then press the MEMORY button. If a station has not been programmed, "NO PRESET" will be displayed and timer setting will be canceled.
- 9 Adjust the volume using the VOLUME control, and then press the MEMORY button. Do not turn the volume up too high.
- 10 Press the ON/STAND-BY button to enter the power stand-by mode. The "TIMER" indicator lights up and the unit is ready for timer playback.

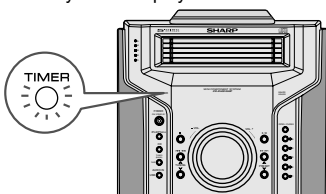

- 11 When the preset time is reached, playback will start. The volume will increase gradually until it reaches the preset volume. The "☉" or "DAILY" indicator will blink during timer playback.
- 12 When the timer end time is reached, the system will enter the power stand-by mode automatically.

Once timer:

The timer will be canceled.

Daily timer:

The timer operates at the same time every day. It will continue until the daily timer setting is canceled. Cancel the daily timer when it is not in use.

Notes:

- When performing timer playback using another unit connected to the USB terminal or AUDIO IN jack, select "USB" or "AUDIO IN" in step 8.
- This unit will turn on or enter the power stand-by mode automatically. However, the connected unit will not turn on or off. To stop the timer playback, follow step "Canceling the timer setting" of this page.

Canceling the timer setting:

- 1 Turn the power on and press and hold down the CLOCK/TIMER button.
- 2 Within 10 seconds, press the ◀◀ or ▶▶ button to select "ONCE" or "DAILY", and press the MEMORY button.
- 3 Within 10 seconds, press the ◀◀ or ▶▶ button to select "ONCE CALL" or "DAILY CALL", and press the MEMORY button.

Canceling the timer setting:

- 1 Turn the power on and press and hold down the CLOCK/TIMER button.
- 2 Within 10 seconds, press the ◀◀ or ▶▶ button to select "ONCE" or "DAILY", and press the MEMORY button.
- 3 Within 10 seconds, press the ◀◀ or ▶▶ button to select "ONCE OFF" or "DAILY OFF", and press the MEMORY button. Timer will be canceled (the setting will not be canceled).

Reusing the memorized timer setting:

The timer setting will be memorized once it is entered. To reuse the same setting, perform the following operations.

- 1 Turn the power on and press and hold down the CLOCK/TIMER button.
- 2 Within 10 seconds, press the ◀◀ or ▶▶ button to select "ONCE" or "DAILY", and press the MEMORY button.
- 3 Within 10 seconds, press the ◀◀ or ▶▶ button to select "ONCE ON" or "DAILY ON", and press the MEMORY button.
- 4 Press the ON/STAND-BY button to enter the power stand-by mode.

■ Sleep operation

The iPod, Audio In, radio, CD, MP3/WMA disc, USB and cassette tape can all be turned off automatically.

- 1 Play back the desired sound source.
- 2 Press the SLEEP button.
- 3 Within 10 seconds, press the SLEEP button repeatedly to select the time and then press the MEMORY button.
10 → 20 → 30 80 → 90
- 4 "SLEEP" will appear.
- 5 The unit will enter the power stand-by mode automatically after the preset time has elapsed. The volume will be turned down 1 minute before the sleep operation finishes.

To confirm the remaining sleep time:

- 1 While "SLEEP" is indicated, press the SLEEP button.

To cancel the sleep operation:

Press the ON/STAND-BY button while "SLEEP" is indicated. To cancel the sleep operation without setting the unit to the stand-by mode, proceed as follows.

- 1 While "SLEEP" is indicated, press the SLEEP button.
- 2 Within 10 seconds, press the SLEEP button repeatedly to select "SLEEP OFF" and then press the MEMORY button.

Timer and sleep operation (Remote control only) (continued)

■ To use timer and sleep operation together

Sleep and timer playback:

For example, you can fall asleep listening to the radio and wake up to CD in the next morning.

- 1 Set the sleep time (see above, steps 1 - 5).
- 2 While the sleep timer is set, set the timer playback (steps 2 - 10, page 12).

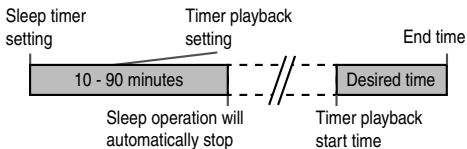

Enhancing your system

The connection cord is not included. Purchase a commercially available cord as shown below.

Portable audio player, etc.

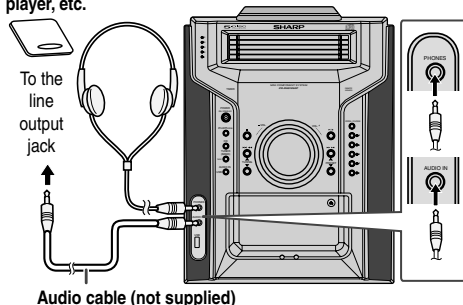

■ Listening to the playback sounds of portable audio player, etc.

- 1 Connect a portable audio player etc. to the front AUDIO IN jack.
- 2 Press the ON/STAND-BY button to turn the power on.
- 3 Press the AUDIO IN/USB button repeatedly to select AUDIO IN.
- 4 Play the connected equipment.
 If volume level of the connected device is too high, sound distortion may occur. Should this happen, lower the volume of the connected device.
 If volume level is too low, increase the volume of the connected device.

Note:

To prevent noise interference, place the unit away from the television.

■ Headphones

- Before plugging in or unplugging the headphones, reduce the volume.
- Be sure your headphones have a 1/8" (3.5 mm) diameter plug and impedance between 16 and 50 ohms. The recommended impedance is 32 ohms.
- Plugging in the headphones disconnects the speakers automatically. Adjust the volume using the VOLUME control.

Troubleshooting chart

Many potential problems can be resolved by the owner without calling a service technician. If something is wrong with this product, check the following before calling your authorized SHARP dealer or service center.

■ General

Symptom	Possible cause
● The clock is not set to the correct time.	● Did a power failure occur? Reset the clock. (Refer page 11)
● When a button is pressed, the unit does not respond.	● Set the unit to the power stand-by mode and then turn it back on. ● If the unit still malfunctions, reset it. (Refer page 14)
● No sound is heard.	● Is the volume level set to "0"? ● Are the headphones connected? ● Are the speaker wires disconnected?

■ CD player

Symptom	Possible cause
● Playback does not start.	● Is the disc loaded upside down?
● Playback stops in the middle or is not performed properly.	● Does the disc satisfy the standards? ● Is the disc distorted or scratched?
● Playback sounds are skipped, or stopped in the middle of a track.	● Is the unit located near excessive vibrations? ● Is the disc very dirty? ● Has condensation formed inside the unit?
● "ER-CD21" appears on the display.	● Is the disc tray stopped with force? Set the unit to the power stand-by mode and then turn it back on.

■ Cassette deck

Symptom	Possible cause
● Sound skipping. ● Cannot hear treble. ● Sound fluctuation.	● Is there any slack? ● Is the tape stretched? ● Are the capstans, pinch rollers, or heads dirty?
● Cannot remove the tape.	● If a power failure occurs during playback, the heads remain engaged with the tape. Do not open the compartment with great force.

Troubleshooting chart (continued)

Remote control

Symptom	Possible cause
<ul style="list-style-type: none"> The remote control does not operate. 	<ul style="list-style-type: none"> Is the AC power cord of the unit plugged in? Is the battery polarity correct? Is the battery dead? Is the distance or angle incorrect? Does the remote control sensor receive strong light?

Tuner

Symptom	Possible cause
<ul style="list-style-type: none"> The radio makes unusual noises continuously. 	<ul style="list-style-type: none"> Is the unit placed near the TV or computer? Is the FM antenna or AM loop antenna placed properly? Move the antenna away from the AC power cord if it is located nearby.

iPod and iPhone

Symptom	Possible cause
<ul style="list-style-type: none"> No sound is produced. No image appears on the TV/monitor. 	<ul style="list-style-type: none"> The iPod or iPhone is not playing. The iPod or iPhone is not properly connected to the unit. Is the AC power cord of the unit plugged in? The video cable is not properly connected. The TV/monitor's input selection is not properly set. The iPod TV out feature has not been set to output video.
<ul style="list-style-type: none"> iPod or iPhone will not charge. 	<ul style="list-style-type: none"> The iPod or iPhone is not making full contact with the connector. The iPod or iPhone is not supported. Refer to page 6 for compatible models.
<ul style="list-style-type: none"> "This accessory is not made to work with iPhone" or similar, appears on iPhone screen. 	<ul style="list-style-type: none"> The iPhone battery is low. Please charge the iPhone. iPhone is not properly docked.

If problem occurs

When this product is subjected to strong external interference (mechanical shock, excessive static electricity, abnormal supply voltage due to lightning, etc.) or if it is operated incorrectly, it may malfunction.

If such a problem occurs, do the following:

- Set the unit to the stand-by mode and turn the power on again.
- If the unit is not restored in the previous operation, unplug and plug in the unit again, and then turn the power on.

Note:

If neither operation above restores the unit, clear all the memory by resetting it.

Factory reset, clearing all memory

- Press the ON/STAND-BY button to enter the power stand-by mode.
- While pressing down the OPEN/CLOSE button and the  button, press the CD button until "CLEAR ALL" appears.



Caution:

This operation will erase all data stored in memory including clock, timer settings, tuner preset, and CD program.

Condensation

Sudden temperature changes, storage or operation in an extremely humid environment may cause condensation inside the cabinet (CD pickup, tape heads, etc.) or on the transmitter on the remote control. Condensation can cause the unit to malfunction. If this happens, leave the power on with no disc (or cassette) in the unit until normal playback is possible (about 1 hour). Wipe off any condensation on the transmitter with a soft cloth before operating the unit.

Before transporting the unit

Remove the iPhone/iPod, USB memory device and disc from the unit. Then, set the unit to the power stand-by mode. Carrying the unit with iPhone/iPod or USB memory device left docked or discs left inside might damage the unit.

Maintenance

Cleaning the cabinet

Periodically wipe the cabinet with a soft cloth and a diluted soap solution, then with a dry cloth.

Caution:

- Do not use chemicals for cleaning (gasoline, paint thinner, etc.). It may damage the cabinet.
- Do not apply oil to the inside of the unit. It may cause malfunctions.

Cleaning the CD pickup lens

In order to ensure proper operation of the CD player, preventative maintenance (cleaning of the laser pickup lens) should be performed periodically. Lens cleaners are commercially available. Contact your local CD software dealer for options.

Specifications

As part of our policy of continuous improvement, SHARP reserves the right to make design and specification changes for product improvement without prior notice. The performance specification figures indicated are nominal values of production units. There may be some deviations from these values in individual units.

■ General

Power source	AC 120 V ~ 60 Hz
Power consumption	100 W
Dimensions	Width: 10 - 1/4" (260 mm) Height: 13 - 9/16" (344 mm) Depth: 13 - 19/32" (345 mm)
Weight	5.0 kg

■ Amplifier

Output power	<p>Front speakers :</p> <p>RMS: Total 200 W (100 W per channel into 6 ohms at 1 kHz, 10% T.H.D.) FTC: 75 W minimum RMS per channel into 6 ohms from 200 Hz to 20 kHz, 10% T.H.D.</p> <p>Subwoofer :</p> <p>RMS: 150 W into 4 ohms at 70 Hz, 10% T.H.D. FTC: 130 W RMS into 4 ohms from 50 Hz to 120 Hz, 10% T.H.D.</p>
Output terminals	<p>Front Speakers: 6 ohms</p> <p>Subwoofer speaker : 4 ohms</p> <p>Headphones: 16 - 50 ohms (recommended: 32 ohms)</p> <p>Video output : 1 Vp-p</p>
Input terminals	<p>Audio In (audio signal): 500 mV/47 k ohms</p>

■ CD player

Type	5-disc multi-play compact disc player
Signal readout	Non-contact, 3-beam semiconductor laser pickup
D/A converter	1-bit D/A converter
Frequency response	20 - 20,000 Hz
Dynamic range	90 dB (1 kHz)

■ Cassette deck

Frequency response	50 - 14,000 Hz (normal tape)
Signal/noise ratio	50 dB (playback)
Wow and flutter	0.35% (WRMS)
Tape speed	4.76 cm/sec. (1 - 7/8 ips)
Heads	Playback

■ USB

USB host interface	Complies with USB 1.1 (Full Speed)/2.0 Mass Storage Class. Support Bulk only and CBI protocol.
Support file	MPEG 1 Layer 3 WMA (Non DRM)
Bitrate support	MP3 (32 ~ 320 kbps) WMA (64 ~ 160 kbps)
Other	<p>Maximum total number of MP3/WMA files is 65025.</p> <p>Maximum total number of folders is 999 INCLUSIVE of root directory. The ID3TAG information supported are TITLE, ARTIST and ALBUM only.</p> <p>Supports ID3TAG version 1 and version 2.</p>
File system support	Support USB devices with Microsoft Windows/DOS/FAT 12/FAT 16/ FAT 32. 2 kbyte block length for sector.

■ Tuner

Frequency range	FM: 87.5 - 108.0 MHz AM: 530 - 1,710 kHz
------------------------	---

■ Speaker

Front Speaker	
Type	2-way type speaker system 2" (5 cm) tweeter 5 - 1/8" (13 cm) woofer
Maximum input power	200 W
Rated input power	100 W
Impedance	6 ohms
Dimensions	Width: 8 - 11/16" (220 mm) Height: 13 - 1/16" (332 mm) Depth: 8 - 3/4" (222 mm)
Weight	6.8 lbs. (3.1 kg) / each
Subwoofer	
Type	Subwoofer system 6 - 5/16" (16 cm) woofer
Maximum input power	300 W
Rated input power	150 W
Impedance	4 ohms
Dimensions	Width: 9 - 1/16" (230 mm) Height: 13 - 1/16" (332 mm) Depth: 12 - 11/16" (322.5 mm)
Weight	10.1 lbs. (4.6 kg)