

SHARP

MUSIC SYSTEM FOR iPod®
& iPhone®
SYSTÈME MUSICAL POUR
iPod et iPhone

MODEL
MODÈLE

DK-CL3P

ENGLISH

Please refer to pages E-1 to E-21.

FRANÇAIS

Se reporter aux pages F-1 à F-21.

OPERATION MANUAL
MODE D'EMPLOI

Made for



iPod



iPhone

iPhone, iPod, iPod classic, iPod nano, and iPod touch are trademarks of Apple Inc., registered in the U.S. and other countries.

iPhone, iPod, iPod classic, iPod nano et iPod touch sont des marques de commerce d'Apple Inc., enregistrées aux É-U et aux autres pays.

Thank you for purchasing this SHARP product.
To obtain the best performance from this product, please read this manual carefully. It will guide you in operating your SHARP product.
Nous vous remercions d'avoir porté votre choix sur ce produit SHARP.
Pour en tirer le meilleur parti, veuillez lire ce mode d'emploi très attentivement.

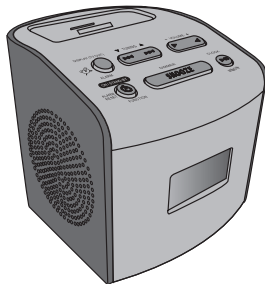

Accessories / Accessoires

Please confirm that only the following accessories are included.
Vérifier que les accessoires ci-dessous sont présents dans l'emballage.



AC/DC adaptor x 1 / Adaptateur CA/CC x1
92L88900013101

iPhone adaptor 12
Adaptateur iPhone 12



92L43200033101

iPhone adaptor 15
Adaptateur iPhone 15



92L43200033201

iPhone adaptor 19
Adaptateur iPhone 19



92L43200033301

SPECIAL NOTES

CAUTION: TO REDUCE THE RISK OF ELECTRIC SHOCK, DO NOT REMOVE COVER (OR BACK). NO USER-SERVICEABLE PARTS INSIDE. REFER SERVICING TO QUALIFIED SERVICE PERSONNEL.

WARNING : TO REDUCE THE RISK OF FIRE OR ELECTRIC SHOCK, DO NOT EXPOSE THIS APPLIANCE TO RAIN OR MOISTURE.

"Made for iPod" and "Made for iPhone" mean that an electronic accessory has been designed to connect specifically to iPod or iPhone, respectively, and has been certified by the developer to meet Apple performance standards. Apple is not responsible for the operation of this device or its compliance with safety and regulatory standards. Please note that the use of this accessory with iPod or iPhone may affect wireless performance.

NOTE

This equipment has been tested and found to comply with the limits for a Class B digital device, pursuant to Part 15 of the FCC Rules. These limits are designed to provide reasonable protection against harmful interference in a residential installation. This equipment generates, uses, and can radiate radio frequency energy and, if not installed and used in accordance with the instructions, may cause harmful interference to radio communications. However, there is no guarantee that interference will not occur in a particular installation. If this equipment does cause harmful interference to radio or television reception, which can be determined by turning the equipment off and on, the user is encouraged to try to correct the interference by one or more of the following measures:

- Reorient or relocate the receiving antenna.
- Increase the separation between the equipment and receiver.
- Connect the equipment into an outlet on a circuit different from that to which the receiver is connected.
- Consult the dealer or an experienced radio/TV technician for help.

WARNING

FCC Regulations state that any unauthorized changes or modifications to this equipment not expressly approved by the manufacturer could void the user's authority to operate this equipment.

FOR YOUR RECORDS

For your assistance in reporting this unit in case of loss or theft, please record below the model number and serial number which are located on the rear of the unit. Please retain this information.

Model number

Serial number

Date of purchase

Place of purchase

IMPORTANT SAFETY INSTRUCTIONS

DK-CL3P

ENGLISH

Electricity is used to perform many useful functions, but it can also cause personal injuries and property damage if improperly handled. This product has been engineered and manufactured with the highest priority on safety. However, improper use can result in electric shock and/or fire. In order to prevent potential danger, please observe the following instructions when installing, operating and cleaning the product. To ensure your safety and prolong the service life of this product, please read the following precautions carefully before use.

- 1) Read these instructions.
- 2) Keep these instructions.
- 3) Heed all warnings.
- 4) Follow all instructions.
- 5) Do not use this apparatus near water.
- 6) Clean only with dry cloth.
- 7) Do not block any ventilation openings. Install in accordance with the manufacturer's instructions.
- 8) Do not install near any heat sources such as radiators, heat registers, stoves, or other apparatus (including amplifiers) that produce heat.
- 9) Do not defeat the safety purpose of the polarized or grounding-type plug. A polarized plug has two blades with one wider than the other. A grounding type plug has two blades and a third grounding prong. The wide blade or the third prong are provided for your safety. If the provided plug does not fit into your outlet, consult an electrician for replacement of the obsolete outlet.
- 10) Protect the power cord from being walked on or pinched particularly at plugs, convenience receptacles, and the point where they exit from the apparatus.
- 11) Only use attachments/accessories specified by the manufacturer.

- 12) Use only with the cart, stand, tripod, bracket, or table specified by the manufacturer, or sold with the apparatus. When a cart is used, use caution when moving the cart/apparatus combination to avoid injury from tip-over.



- 13) Unplug this apparatus during lightning storms or when unused for long periods of time.
- 14) Refer all servicing to qualified service personnel. Servicing is required when the apparatus has been damaged in any way, such as power-supply cord or plug is damaged, liquid has been spilled or objects have fallen into the apparatus, the apparatus has been exposed to rain or moisture, does not operate normally, or has been dropped.

Additional Safety Information

- 15) Power Sources - This product should be operated only from the type of power source indicated on the marking label. If you are not sure of the type of power supply to your home, consult your product dealer or local power company. For product intended to operate from battery power, or other sources, refer to the operating instructions.
- 16) Overloading - Do not overload wall outlets, extension cords, or integral convenience receptacles as this can result in a risk of fire or electric shock.
- 17) Object and Liquid Entry - Never push objects of any kind into this product through openings as they may touch dangerous voltage points or short-out parts that could result in a fire or electric shock. Never spill liquid of any kind on the product.

Important Instruction

IMPORTANT SAFETY INSTRUCTIONS (continued)

ENGLISH

Important Instruction

- 18) **Damage Requiring Service** - Unplug this product from the wall outlet and refer servicing to qualified service personnel under the following conditions:
- When the AC cord or plug is damaged,
 - If liquid has been spilled, or objects have fallen into the product,
 - If the product has been exposed to rain or water,
 - If the product does not operate normally by following the operating instructions. Adjust only those controls that are covered by the operating instructions as an improper adjustment of other controls may result in damage and will often require extensive work by a qualified technician to restore the product to its normal operation,
 - If the product has been dropped or damaged in any way, and
 - When the product exhibits a distinct change in performance - this indicates a need for service.
- 19) **Replacement Parts** - When replacement parts are required, be sure the service technician has used replacement parts specified by the manufacturer or have the same characteristics as the original part. Unauthorized substitutions may result in fire, electric shock, or other hazards.
- 20) **Safety Check** - Upon completion of any service or repairs to this product, ask the service technician to perform safety checks to determine that the product is in proper operating condition.
- 21) **Wall or ceiling mounting** - When mounting the product on a wall or ceiling, be sure to install the product according to the method recommended by the manufacturer.
- 22) **Power Lines** - An outside antenna system should not be located in the vicinity of overhead power lines or other electric light or power circuits, or where it can fall into such power lines or circuits. When installing an outside antenna system, extreme care should be taken to keep from touching such power lines or circuits as contact with them might be fatal.
- 23) **Protective Attachment Plug** - The product is equipped with an attachment plug having overload protection. This is a safety feature. See Instruction Manual for replacement or resetting of protective device. If replacement of the plug is required, be sure the service technician has used a replacement plug specified by the manufacturer that has the same overload protection as the original plug.
- 24) **Stand** - Do not place the product on an unstable cart, stand, tripod or table. Placing the product on an unstable base can cause the product to fall, resulting in serious personal injuries as well as damage to the product. Use only a cart, stand, tripod, bracket or table recommended by the manufacturer or sold with the product. When mounting the product on a wall, be sure to follow the manufacturer's instructions. Use only the mounting hardware recommended by the manufacturer.

SPECIAL NOTES

ENERGY STAR® Program Information



Products that have earned the ENERGY STAR® are designed to protect the environment through superior energy efficiency.

ENERGY STAR® is a U.S. registered mark.

Contents

	Page
■ General Information	
Precautions	5
Controls and indicators	6 - 7
■ Preparation for Use	
System connections	8 - 9
■ Basic Operation	
General control	10
Setting the time and date	11
■ iPod and iPhone	
Listening to the iPod and iPhone	12 - 14
■ Radio	
Listening to the radio	14 - 15
■ Advanced Features	
Alarm operation	16 - 17
Enhancing your system	17 - 18
■ References	
Troubleshooting chart	18 - 19
Maintenance	20
Specifications	20
CONSUMER LIMITED WARRANTY	21 - 22

Precautions

■ General

- Please ensure that the equipment is positioned in a well-ventilated area and ensure that there is at least 4" (10 cm) of free space along the sides, top and back of the equipment.

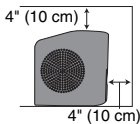

- Use the unit on a firm, level surface free from vibration.

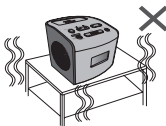

- Keep the unit away from direct sunlight, strong magnetic fields, excessive dust, humidity and electronic/electrical equipment (home computers, facsimiles, etc.) which generate electrical noise.



- Do not place anything on top of the unit.
- Do not expose the unit to moisture, to temperatures higher than 140°F (60°C) or to extremely low temperatures.
- If your system does not work properly, disconnect the AC/DC adaptor from the AC outlet. Plug the AC/DC adaptor back in, and then turn on your system.
- In case of an electrical storm, unplug the unit for safety.

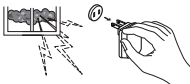

- Hold the AC/DC adaptor by the head when removing it from the AC outlet, as pulling the cord can damage internal wires.

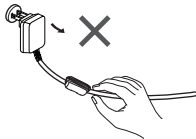

- The AC/DC adaptor is used as a disconnect device and shall always remain readily operable.

- **Do not remove the outer cover, as this may result in electric shock. Refer internal service to your local SHARP service facility.**

- This unit should only be used within the range of 41°F - 95°F (5°C - 35°C).

- To prevent fire or shock hazard, do not expose this appliance to dripping or splashing. No object filled with liquids, such as vases shall be placed on the apparatus.

Warning:

The voltage used must be the same as that specified on this unit. Using this product with a higher voltage other than that which is specified is dangerous and may result in a fire or other type of accident causing damage. SHARP will not be held responsible for any damage resulting from use of this unit with a voltage other than that which is specified.

■ Volume control

The sound level at a given volume setting depends on speaker efficiency, location and various other factors. It is advisable to avoid exposure to high volume levels, which occurs while turning the unit on with the volume control setting up high, or while continually listening at high volumes.

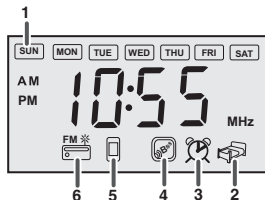
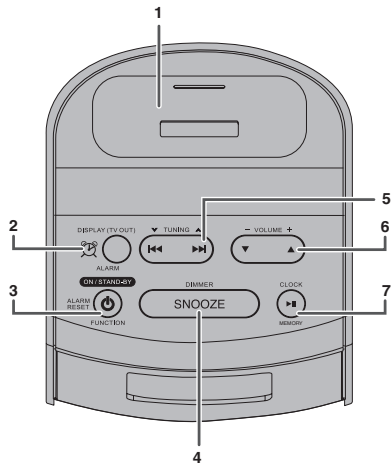

■ Top panel

Reference page

1. iPod and iPhone Dock 13
2. DISPLAY (TV OUT)/ALARM Button 8, 14
3. ON/STAND-BY/Alarm Reset/
FUNCTION Button 8, 10, 13, 14, 15, 18
4. Snooze/Dimmer Button 10
5. Previous/Next/Tuning Up/Down Button ... 11, 14, 15
6. Volume Up/Down Button 10
7. Clock/MEMORY/PLAY/PAUSE Button 11, 14

■ Display

Reference page

1. Day Indicator 11
2. Snooze Indicator 17
3. Alarm Indicator 16
4. Buzzer Indicator 16
5. iPod/iPhone Indicator 16
6. FM Tuner Indicator 15

Controls and indicators (continued)

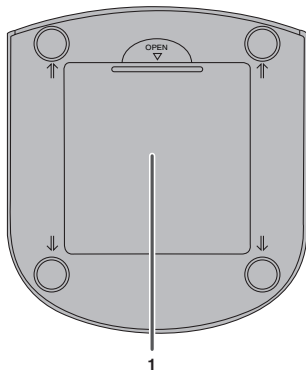

■ Bottom view

- | | |
|------------------------------|----------------|
| | Reference page |
| 1. Battery Compartment | 9 |

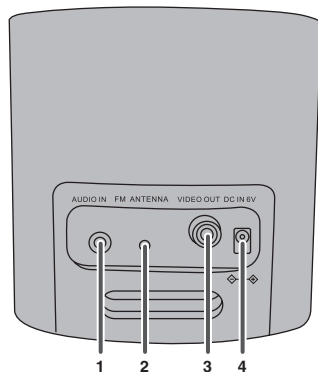

■ Rear panel

- | | |
|----------------------------------|----------------|
| | Reference page |
| 1. AUDIO IN Jack | 17 |
| 2. FM Antenna Wire (fixed) | 15 |
| 3. Video Out Jack | 8 |
| 4. DC Input Jack | 8 |

System connection

DK-CL3P

ENGLISH

Make sure to unplug the AC/DC adaptor before making any connections.

■ Connecting iPod or iPhone to TV

Video files from iPod or iPhone can be viewed by connecting the system to TV/monitor.

If the TV/monitor has a video input, connect it to the VIDEO OUT jack at the back of the unit and set the TV Out on the iPod or iPhone unit to "ON" position.

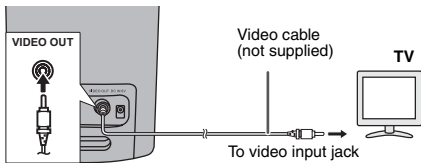

■ Watching videos on a TV connected to iPod

1 Press the FUNCTION button on the main unit to select the iPod function.

2 Enter the iPod or iPhone menu.

Press and hold DISPLAY(TV OUT) button on main unit until ON appear on display.

3 Select the desired video to be played.

4 Press the ENTER button on the iPod unit to start playback.

For iPod touch and iPhone, playback will automatically start once the desired file is selected.

Notes:

- To return to watch video on iPod or iPhone screen, return to the iPod menu. Press and hold the DISPLAY(TV OUT) on main unit until "OFF" appear on display.
- During iPod video playback, pressing the DISPLAY(TV OUT) button until "OFF" appear on display will not toggle video out between iPod and TV.

- Please make sure to set iPod unit to either NTSC or PAL to match your TV signal. Please visit Apple's home page for further information.
- Customer should also refer iPod operation manual before making video out setting.

■ AC/DC adaptor connection

1 Plug the AC/DC adaptor cable into the DC IN jack on the unit.

2 Plug the AC/DC adaptor into an AC outlet.

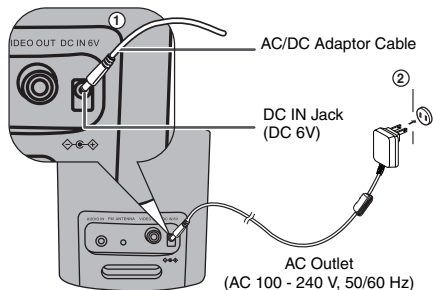

Notes:

- Unplug the AC/DC adaptor from the AC outlet if the unit will not be used for a prolonged period of time.
- Use only the supplied AC/DC adaptor. Using other AC/DC adaptor may cause an electric shock or fire.
- During unit operational with batteries, iPod/iPhone attached can be used for playback only.

CAUTION:

TO PREVENT ELECTRIC SHOCK, MATCH WIDE BLADE OF PLUG TO WIDE SLOT, FULLY INSERT.

System connections (continued)

■ Install/Replace backup batteries

Use 4 "AA" size batteries (UM/SUM-3, R6, HP-7 or similar). Batteries are not included.

1 Open the battery cover.

2 Insert the batteries according to the direction indicated in the battery compartment.

When inserting or removing the batteries, push them towards the ⊖ battery terminal.

3 Close the cover.

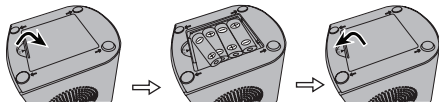

Notes:

- Backup battery system is used to provide continuous alarm operation and clock setting in event of a power failure. During battery replacement, please make sure the AC/DC adaptor is connected, otherwise all settings may be lost.
- Remove the batteries if the unit will not be used for a long period of time to prevent battery leakage which may cause potential damage.
- The first time the batteries are installed, the clock will blink on the display. Please set the time and date (refer page 11).

Note:

Battery life may vary depending on the temperature, battery types and usage conditions.

Precautions for battery use:

- Installing the batteries incorrectly may cause the unit to malfunction.
- Insert the batteries according to the direction indicated in the battery compartment.
- Replace all old batteries with new ones at the same time.
- Do not mix old and new batteries.
- Batteries (battery pack or batteries installed) shall not be exposed to excessive heat such as sunshine, fire or the like.

Caution:

Do not use rechargeable batteries (nickel-cadmium battery, etc.).

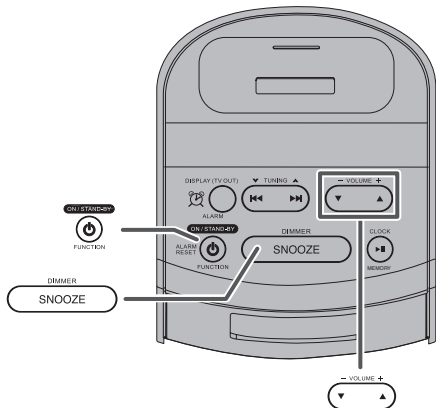

■ To turn the power on

Press the ON/STAND-BY button to turn the power on. The first time power is supplied to the unit, the clock will be blinking on the display. Please set the time and date (refer page 11).

After use:

Press and hold the ON/STAND-BY button to enter the power stand-by mode.

■ Display brightness control (DIMMER)

Press the SNOOZE/DIMMER button to adjust the brightness of LCD display.

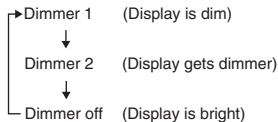

Notes:

- Setting dimmer to display in the brightest mode during battery operation will affect battery life.
- During battery operation in standby mode, the brightness of the display will automatically go to the lowest mode (dim OFF) after 5 seconds.

■ Volume auto set in

If you turn off and on the main unit with the volume set to 17 or higher, the volume starts at 16.

■ Volume control

Press the VOLUME (+ or -) button to increase or decrease the volume. Volume indicator will be blinking when volume reaches maximum and minimum level.

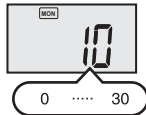

Setting the time and date

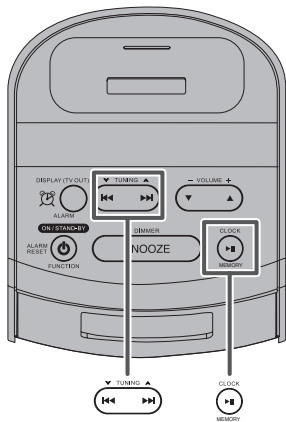

In this example, the clock is set for the 12-H (12 hour) display.

- 1 In standby mode, press the CLOCK button for more than 2 seconds. The clock time display will blinking.**

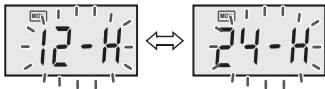

Press the \lll or \ggg button to select clock time display format and then press CLOCK button.

- 2 Press the \lll or \ggg button to adjust the hour and then press the CLOCK button.**



Press the \lll or \ggg button once to advance the time by 1 hour. Hold it down to advance continuously. "AM" or "PM" indicator will interchange after each 12 hour cyclic in 12-H clock format.

- 3 Press the \lll or \ggg button to adjust the minutes and then press the CLOCK button.**



Press the \lll or \ggg button once to advance the time by 1 minute. Hold it down for about 2 seconds to change the time in 5-minutes interval.

- 4 Press the \lll or \ggg button to adjust the day and then press the CLOCK button.**



“.” will be blinking to indicate time and date setting is completed.

Note:

During battery operations in standby mode, press the SNOOZE/DIMMER button to display the clock for about 5 seconds.

Listening to the iPod and iPhone

iPod and iPhone operations

Made for:

- iPhone 4
- iPhone 3GS
- iPhone 3G
- iPhone
- iPod touch (3rd generation)
- iPod touch (2nd generation)
- iPod touch (1st generation)
- iPod classic
- iPod with video
- iPod nano (5th generation)
- iPod nano (4th generation)
- iPod nano (3rd generation)
- iPod nano (2nd generation)
- iPod nano (1st generation)
- iPod with colour display
- iPod mini

Caution:

- Please update your iPod and iPhone unit to the latest software version before using it. Please visit Apple's homepage to download the latest version for your iPod and iPhone.

Notes:

- Once the iPod or iPhone is connected to the unit it will begin charging.
- If you have an iPod or iPhone that does not have an iPod 30 Pin connector, you can use an auxiliary cable to connect it to the AUDIO IN jack.
- The message "This accessory is not made to work with iPhone" or similar, may appear on the iPhone screen when:
 - battery is low.
 - the iPhone is not properly docked (eg. slanting).If this occurs, remove and re-dock the iPhone.
- The iPod or iPhone will not be charged while the main unit uses batteries as power supply.

■ iPod and iPhone adaptor connection

Note:

You can use an audio cable to connect your iPod or iPhone to the AUDIO IN socket if:

1. your iPod or iPhone adaptor does not fit into the dock on the main unit.
2. you have an iPod or iPhone that does not have an iPod or iPhone adaptor.
3. you have an iPod that does not have an iPod 30 pin connector.

iPhone Adaptor No.	iPhone Description	Capacity
12	iPhone	4GB & 8GB & 16GB
15	iPhone 3G	8GB & 16GB
15	iPhone 3GS	16GB & 32GB
19	iPhone 4	16GB & 32GB

Listening to the iPod and iPhone (continued)

■ To insert iPod or iPhone adaptor

1. Insert the iPod or iPhone adaptor into unit and connect your iPod or iPhone.

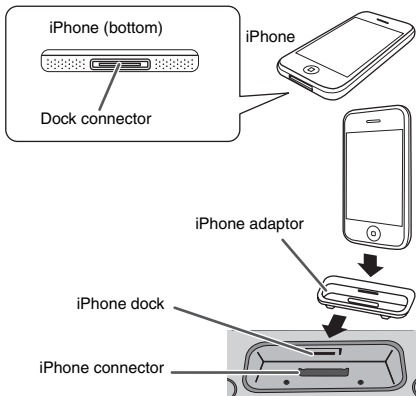

Caution:

Unplug all accessories for the iPod or iPhone before inserting it into the dock.

■ To remove iPod or iPhone adaptor

Insert the tip of a screwdriver ("-" type, small) into the adaptor hole as shown and lift upward to remove.

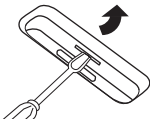

■ iPod or iPhone playback

- 1 Press the ON/STAND-BY button to turn the power on.
- 2 Press the FUNCTION button on main unit to select the iPod function.
- 3 Insert iPod or iPhone unit in the dock of main unit.

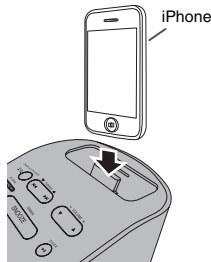





- 4 Press the ►/|| button on the iPod unit to start playback.

For iPod touch and iPhone, playback will automatically start once the desired file is selected.

■ To disconnect iPod or iPhone

Simply remove the iPod or iPhone from the dock. It is safe to do so even during playback.

■ Various iPod or iPhone functions

Function	Main unit	Operation
Play	CLOCK  MEMORY	Press in the pause mode.
Pause	CLOCK  MEMORY	Press in the playback mode.
Track up/down	▼ TUNING ▲ 	Press in the playback or pause mode. If you press the button in the pause mode, press the ►/ button to start the desired track.
Fast forward/ reverse	▼ TUNING ▲ 	Press and hold down in the playback mode. Release the button to resume playback.
TV OUT	DISPLAY (TV OUT)  ALARM	Press for more than 2 seconds to toggle the video out display between iPod or iPhone and TV.

iPod and iPhone operation

The operations described above depend on the generation iPod or iPhone you are using.

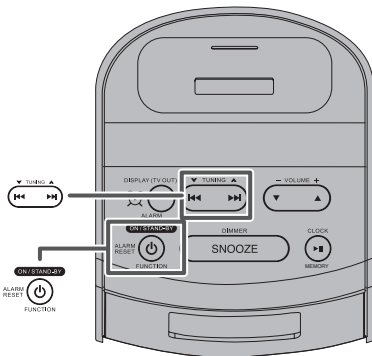

■ Tuning

- 1 Press the **ON/STAND-BY** button to turn the power on.
- 2 Press the **FUNCTION** button to select the Tuner function.

Listening to the radio (continued)

3 Tune to the desired station.

Manual tuning:

Press the TUNING (∨ or ∧) button as many times as required to tune in to the desired station.

Auto tuning:

When the TUNING (∨ or ∧) button is pressed for more than 0.5 seconds, scanning will start automatically and the tuner will stop at the first receivable broadcast station.

Notes:

- After 5 seconds the tuner frequency will change to time display. To preview the tuner frequency, press DISPLAY(TV OUT) button.
- When radio interference occurs, auto scan tuning may stop automatically at that point.
- Auto scan tuning will skip weak signal stations.
- To stop the auto tuning, press the TUNING (∨ or ∧) button again.

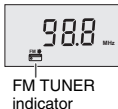

Receiving an FM stereo transmission:

- If the FM reception is weak, the reception will auto changes to monaural, and the sound becomes clearer.

■ Programming a station

You can store 20 FM stations in memory and recall them at the push of a button. (Preset tuning)

1 Perform steps 1 - 3 in "Tuning" on pages 14 - 15.

2 While the Tuner frequency is display, press the MEMORY button for more than 2 seconds on the main unit to enter the preset tuning saving mode.



3 Within 5 seconds, press the MEMORY button repeatedly to select the preset channel number.

Store the stations in memory, in order, starting with preset channel 1.

4 Within 5 seconds, press and hold the MEMORY button on main unit to store that station in memory.

If the preset number indicators disappear before the station is programmed, repeat the operation from step 2.

5 Repeat steps 1 - 4 to set other stations, or to change a preset station.

When a new station is stored in memory, the station previously programmed for that preset channel number will be erased.

Note:

The backup batteries function protects the programmed stations should there be a power failure or the AC/DC adaptor becomes disconnected. If the backup batteries are drain off, the programmed stations will be erased.

■ To recall a programmed station

Press MEMORY button repeatedly to select the desired programmed station.

Alarm operation

■ Alarm

The unit turns on and play desired source (iPod, iPhone or TUNER) or Buzzer sound for 1 hour alarm cycle.

Before setting the alarm:

- 1 Check that the clock is set to the correct time. (refer page 11)
If it is not set, you cannot use the alarm function.
- 2 For iPod playback: Insert iPod or iPhone to the unit. (refer page 13)
- 3 For TUNER: Set preset memory. (refer page 15)



Setting the alarms

- 1 In standby mode, press and hold the ALARM button until the alarm time and alarm icon blinking.



- 2 Press the ◀ or ▶ button to adjust the hour and press the ALARM button.



Press the ◀ or ▶ button once to advance the time by 1 hour. Hold it down to advance continuously. "AM" or "PM" indicator will interchange after each 12 hour cyclic.

- 3 Press the ◀ or ▶ button to adjust the minutes and then press the ALARM button.



Press the ◀ or ▶ button once to advance the time by 1 minute. Hold it down to change the time in 5 minutes interval.

- 4 Press the ◀ or ▶ button to select the day for the alarm and then press alarm button.



Everyday: MON - SUN (Alarm activate daily)
Weekday: MON - FRI (Alarm activate from Monday to Friday only)
Weekend: SAT - SUN (Alarm activate from Saturday to Sunday only)

- 5 Press the ◀ or ▶ button to select the wake up source and then press the ALARM button.



Wake up source selection:

BUZZER → RADIO → iPod
↑

Alarm icon "🔔" will light up to indicate alarm setting is complete.

Alarm operation (continued)

Note:

If wake up source is set to iPod, and iPod is not present, the alarm source will change to default Buzzer.

■ Activate and deactivate the alarm

- 1 During standby mode, press **ALARM** button to deactivate current alarm times and wake up source.
- 2 Press **ALARM** button again to reactivate the last alarm function. When the alarm setting time is activated, alarm information will shown for 5 seconds and alarm icon (🔔) will appear on display.



- 3 When alarm has started, alarm icon (🔔) will blinking on the display.

Daily Alarm:

- During alarm is function, press **ALARM RESET** button to stop alarm and it will come again on the next day.



Sure Alarm:

- When power failure, the alarm will function if the backup batteries are installed.

■ Snooze function

Once alarm has started, pressing the **SNOOZE/DIMMER** button will stop alarm for 9 minutes.

During snooze, "🔔" icon will light up and "🔔" icon will blinking.

Once the snooze time has expired, alarm will continue.

The snooze function can be operated during 1 hour alarm cycle.

Enhancing your system

The auxiliary cable is not included. Purchase a separate auxiliary cable as shown below.

Portable audio player



Computer



To the line output jack



Auxiliary cable
(not supplied)

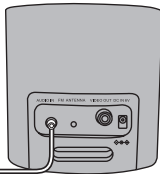

Troubleshooting chart

Many potential problems can be resolved by the owner without calling a service technician.

If something is wrong with this product, check the following before calling your authorized SHARP dealer or service center.

■ Listening to the audio/video sounds from portable audio player, computer etc.

- 1 Use the auxiliary cable to connect the portable audio player, computer etc. to the AUDIO IN jack.

When using video equipment, connect the audio output to this unit and the video output to a television.

- 2 Press the ON/STAND-BY button to turn the power on.
- 3 Press the FUNCTION button to select AUX function.
- 4 Play the connected equipment.

Note:

To prevent noise interference, place the unit away from the television and do not make any auxiliary playback while listening to the iPod or iPhone.

■ General

Symptom	Possible cause
<ul style="list-style-type: none"> ● The clock is not set to the correct time. 	<ul style="list-style-type: none"> ● Did a power failure occur? Reset the clock. (Refer to page 11)
<ul style="list-style-type: none"> ● When a button is pressed, the unit does not respond. 	<ul style="list-style-type: none"> ● Set the unit to the power stand-by mode and then turn it back on. ● If the unit still malfunctions, reset it. (Refer to page 19)
<ul style="list-style-type: none"> ● No sound is heard. 	<ul style="list-style-type: none"> ● Is the volume level set to "0"?

■ Tuner

Symptom	Possible cause
<ul style="list-style-type: none"> ● The radio makes unusual noises continuously. 	<ul style="list-style-type: none"> ● Is the unit placed near the TV or computer? ● Is the FM antenna placed properly? Move the antenna away from the AC/DC adaptor if it is located nearby.

Troubleshooting chart (continued)

■ iPod and iPhone

Symptom	Possible cause
<ul style="list-style-type: none"> No sound is produced. No image appears on the TV/monitor. 	<ul style="list-style-type: none"> The iPod or iPhone unit software version is not update to the latest version. Please visit Apple's homepage. The iPod or iPhone is not playing. The iPod or iPhone is not properly connected to the unit. Is the AC/DC adaptor of the unit plugged in? The video cable is not properly connected. The TV/monitor's input selection is not properly set.
<ul style="list-style-type: none"> iPod or iPhone will not charge. 	<ul style="list-style-type: none"> The iPod or iPhone is not making full contact with the connector. Is the AC/DC adaptor of the unit plugged in? Using iPod (3rd generation). The main unit is using batteries as power supply. The iPod or iPhone is not compatible. Refer page 12 for compatible models.
<ul style="list-style-type: none"> "This accessory is not made to work with iPhone" or similar appears on iPhone screen. 	<ul style="list-style-type: none"> The iPhone battery is low. Please charge the iPhone. iPhone not properly docked.

■ Condensation

Sudden temperature changes, storage or operation in an extremely humid environment may cause condensation inside the cabinet or on the transmitter on the remote control.

Condensation can cause the unit to malfunction. If this happens, leave the power on until normal playback is possible (about 1 hour). Wipe off any condensation on the transmitter with a soft cloth before operating the unit.

■ If problem occurs

When this product is subjected to strong external interference (mechanical shock, excessive static electricity, abnormal supply voltage due to lightning, etc.) or if it is operated incorrectly, it may malfunction.

If such a problem occurs, do the following:

- Set the unit to the stand-by mode and turn the power on again.
- If the unit is not restored in the previous operation, unplug and plug in the unit, and then turn the power on.

Note:

If neither operation above restores the unit, remove the backup batteries.

■ Clearing all the memory (reset)

During standby mode, press and hold SNOOZE button for 5 seconds. Display will become blank for awhile and main unit will reset.

Caution:

This operation will erase all data stored in memory including clock, alarm settings and tuner preset.

■ Before transporting the unit

Remove the iPod or iPhone from the unit. Then, set the unit to the power standby mode. Carrying the unit with iPod or iPhone left docked might damage both systems.

■ Cleaning the unit

Periodically wipe the unit with a clean soft cloth.

Caution:

- Do not use chemicals for cleaning (gasoline, paint thinner, etc.). It may damage the unit finishing.
- Do not apply oil to the inside of the unit. It may cause malfunctions.

Specifications

As part of our policy of continuous improvement, SHARP reserves the right to make design and specification changes for product improvement without prior notice. The performance specification figures indicated are nominal values of production units. There may be some deviations from these values in individual units.

■ General

Power source	DC IN 5.9V \pm 2A: AC/DC adaptor (AC 100 - 240 V \sim 50/60 Hz) 6V \pm (UM-3/SUM-3, R6/AA) x 4
Power consumption	11 W
Output power	Front speakers: 0.6 W watts minimum RMS per channel into 8 ohms from 100 Hz to 20 kHz, 10% total harmonic distortion.

Speaker	1-way type speaker system 2.5" (6.5 cm) Full Range
Speaker maximum input power	1.2 W/Channel
Speaker rated input power	0.6 W/Channel
Output terminals	Video output: 1Vp-p
Input terminals	Auxiliary (audio signal): 500 mV/47 k ohms
Dimensions	Width: 4" (100 mm) Height: 33/4" (96.2 mm) Depth: 45/14" (110 mm)
Weight	0.77 lbs. (0.35 kg)

■ Tuner

Frequency range	FM: 87.5 - 108.0 MHz
------------------------	----------------------

CONSUMER LIMITED WARRANTY

SHARP ELECTRONICS CORPORATION warrants to the first consumer purchaser that this Sharp brand product (the "Product"), when ship in its original container, will be free from defective workmanship and materials, and agrees that it will, at its option, either repair the defect or replace the defective Product or part thereof with a new or remanufactured equivalent at no charge to the purchaser for parts or labor for the period(s) set forth below.

This warranty does not apply to any appearance items of the Product nor to the additional excluded item(s) set forth below nor to any Product the exterior of which has been damaged or defaced, which has been subjected to improper voltage or other misuse, abnormal service or handling, or which has been altered or modified in design or construction.

In order to enforce the rights under this limited warranty, the purchaser should follow the steps set forth below and provide proof of purchase to the servicer.

The limited warranty described herein is in addition to whatever implied warranties may be granted to purchasers by law. ALL IMPLIED WARRANTIES INCLUDING THE WARRANTIES OF MERCHANTABILITY AND FITNESS FOR USE ARE LIMITED TO THE PERIOD(S) FROM THE DATE OF PURCHASE SET FORTH BELOW. Some states do not allow limitations on how long an implied warranty lasts, so the above limitation may not apply to you.

Neither the sales personnel of the seller nor any other person is authorized to make any warranties other than those described herein, or to extend the duration of any warranties beyond the time period described herein on behalf of Sharp.

The warranties described herein shall be the sole and exclusive warranties granted by Sharp and shall be the sole and exclusive remedy available to the purchaser. Correction of defects, in the manner and for the period of time described herein, shall constitute complete fulfillment of all liabilities and responsibilities of Sharp to the purchaser with respect to the Product, and shall constitute full satisfaction of all claims, whether based on contract, negligence, strict liability or otherwise. In no event shall Sharp be liable, or in any way responsible, for any damages or defects in the Product which were caused by repairs or attempted repairs performed by anyone other than an authorized servicer. Nor shall Sharp be liable or in any way responsible for any incidental or consequential economic or property damage. Some states do not allow the exclusion of incidental or consequential damages, so the above exclusion may not apply to you.

THIS WARRANTY GIVES YOU SPECIFIC LEGAL RIGHTS. YOU MAY ALSO HAVE OTHER RIGHTS WHICH VARY FROM STATE TO STATE.

Model Specific Section

Your Product Model Number & Description:

DK-CL3P MUSIC SYSTEM for iPod & iPhone

(Be sure to have this information available when you need service for your Product.)

Warranty Period for this Product:

One (1) year parts and labor from the date of purchase.

Additional Item(s) Excluded from Warranty Coverage (if any):

Non-functional accessories, supplies, and consumable items.

Where to Obtain Service:

At a Sharp Authorized Servicer located in the United States.

To find a location of the nearest Sharp Authorized Servicer, call Sharp toll free at 1-800-BE-SHARP.

What to do to Obtain Service:

Ship your Product prepaid to a Sharp Authorized Servicer

Be sure to have **Proof of Purchase** available. If you ship the Product, be sure it is insured and packaged securely.

TO OBTAIN SUPPLY, ACCESSORY OR PRODUCT INFORMATION, CALL 1-800-BE-SHARP.

SHARP

SHARP ELECTRONICS CORPORATION

Sharp Plaza, Mahwah, New Jersey 07495 - 1163

SHARP CORPORATION

LIMITED WARRANTY

Consumer Electronics Products
Congratulations on your purchase!

Sharp Electronics of Canada Ltd. (hereinafter called "Sharp") gives the following express warranty to the first consumer purchaser for this Sharp brand product, when shipped in its original container and sold or distributed in Canada by Sharp or by an Authorised Sharp Dealer:

Sharp warrants that this product is free, under normal use and maintenance, from any defects in material and workmanship. If any such defects should be found in this product within the applicable warranty period, Sharp shall, at its option, repair or replace the product as specified herein.

This warranty shall not apply to:

- Any defects caused or repairs required as a result of abusive operation, negligence, accident, improper installation or inappropriate use as outlined in the owner's manual.
- Any Sharp product tampered with, modified, adjusted or repaired by any party other than Sharp, Sharp's Authorised Service Centres or Sharp's Authorised Servicing Dealers.
- Damage caused or repairs required as a result of the use with items not specified or approved by Sharp, including but not limited to head cleaning tapes and chemical cleaning agents.
- Any replacement of accessories, glassware, consumable or peripheral items required through normal use of the product including but not limited to earphones, remote controls, AC adapters, batteries, temperature probe, stylus, trays, filters, belts, ribbons, cables and paper.
- Any cosmetic damage to the surface or exterior that has been defaced or caused by normal wear and tear.
- Any damage caused by external or environmental conditions, including but not limited to transmission line/power line voltage or liquid spillage.
- Any product received without appropriate model, serial number and CSA/cUL markings.
- Any products used for rental or commercial purposes.
- Any installation, setup and/or programming charges.

Should this Sharp product fail to operate during the warranty period, warranty service may be obtained upon delivery of the Sharp product together with proof of purchase and a copy of this LIMITED WARRANTY statement to an Authorised Sharp Service Centre or an Authorised Sharp Servicing Dealer. In home warranty service may be provided at Sharp's discretion on any Sharp television with the screen size of 27" or larger and on any Sharp Over The Range Microwave Oven.

This warranty constitutes the entire express warranty granted by Sharp and no other dealer, service centre or their agent or employee is authorised to extend, enlarge or transfer this warranty on behalf of Sharp. To the extent the law permits, Sharp disclaims any and all liability for direct or indirect damages or losses or for any incidental, special or consequential damages or loss of profits resulting from a defect in material or workmanship relating to the product, including damages for the loss of time or use of this Sharp product or the loss of information. The purchaser will be responsible for any removal, reinstallation, transportation and insurance costs incurred. Correction of defects, in the manner and period of time described herein, constitute complete fulfilment of all obligations and responsibilities of Sharp to the purchaser with respect to the product and shall constitute full satisfaction of all claims, whether based on contract, negligence, strict liability or otherwise.

WARRANTY PERIODS

Colour Television	1 year (picture tube 1 additional year)	LCD Projector	1 year (bulb 90 days)
LCD TV	1 year	Video Cassette Recorder	1 year
Camcorder	1 year	TV/VCR Combo	1 year (picture tube 1 additional year)
Audio Products	1 year	Microwave Oven	2 years (magnetron 3 additional years for part only)
Vacuum Cleaner	1 year	DVD Player	1 year

To obtain the name and address of the nearest Authorised Sharp Service Centre or Dealer, please contact:

SHARP ELECTRONICS OF CANADA LTD.

SHARP ELECTRONICS OF CANADA LTD

335 Britannia Road East
 Mississauga, Ontario
 L4Z 1W9

(905) 568-7140 or 1-(877) SHARP-CC

Web site: www.sharp.ca



MEMO/MÉ MORANDUM

MEMO/MÉ MORANDUM

SHARP

SHARP ELECTRONICS OF CANADA LTD.

335 Britannia Road East, Mississauga, Ontario L4Z 1W9

SHARP CORPORATION



PRINTED IN CHINA
IMPRIMÉ EN CHINE
92L87500013101
10K R KI ①