

SHARP



1-BIT DIGITAL HOME THEATER
ENSEMBLE HOME THEATER 1 BIT

SD-AT50

DVD PLAYER
LECTEUR DVD

DX-AT50

OPERATION MANUAL
MODE D'EMPLOI



ENGLISH

Please refer to
pages i to iv and
E-1 to E-52.

FRANÇAIS

Se reporter aux
pages iv et
F-1 à F-52.

SPECIAL NOTES (for Users in the U.S.A.)



CAUTION
RISK OF ELECTRIC SHOCK
DO NOT OPEN



CAUTION: TO REDUCE THE RISK OF ELECTRIC SHOCK, DO NOT REMOVE COVER (OR BACK). NO USER-SERVICEABLE PARTS INSIDE. REFER SERVICING TO QUALIFIED SERVICE PERSONNEL.

Explanation of Graphical Symbols:



The lightning flash with arrowhead symbol, within an equilateral triangle, is intended to alert the user to the presence of uninsulated "dangerous voltage" within the product's enclosure that may be of sufficient magnitude to constitute a risk of electric shock to persons.



The exclamation point within an equilateral triangle is intended to alert the user to the presence of important operating and maintenance (servicing) instructions in the literature accompanying the appliance.

0010

WARNING: TO REDUCE THE RISK OF FIRE OR ELECTRIC SHOCK, DO NOT EXPOSE THIS APPLIANCE TO RAIN OR MOISTURE.

0010

Note to CATV system installer:

This reminder is provided to call the CATV system installer's attention to Article 820-40 of the National Electrical Code that provides guidelines for proper grounding and, in particular, specifies that the cable ground shall be connected to the grounding system of the building, as close to the point of cable entry as practical.

NOTE

This equipment has been tested and found to comply with the limits for a Class B digital device, pursuant to Part 15 of the FCC Rules. These limits are designed to provide reasonable protection against harmful interference in a residential installation. This equipment generates, uses, and can radiate radio frequency energy and, if not installed and used in accordance with the instructions, may cause harmful interference to radio communications. However, there is no guarantee that interference will not occur in a particular installation. If this equipment does cause harmful interference to radio or television reception, which can be determined by turning the equipment off and on, the user is encouraged to try to correct the interference by one or more of the following measures:

- Reorient or relocate the receiving antenna.
- Increase the separation between the equipment and receiver.
- Connect the equipment into an outlet on a circuit different from that to which the receiver is connected.
- Consult the dealer or an experienced radio/TV technician for help.

WARNING

FCC Regulations state that any unauthorized changes or modifications to this equipment not expressly approved by the manufacturer could void the user's authority to operate this equipment.

CAUTION:

THIS PRODUCT IS A CLASS 1 LASER PRODUCT. USE OF CONTROLS OR ADJUSTMENTS OR PERFORMANCE OF PROCEDURES OTHER THAN THOSE SPECIFIED HEREIN MAY RESULT IN HAZARDOUS RADIATION EXPOSURE. AS THE LASER BEAM USED IN THIS PRODUCT IS HARMFUL TO THE EYES, DO NOT ATTEMPT TO DISASSEMBLE THE CABINET. REFER SERVICING TO QUALIFIED PERSONNEL ONLY.

0207

FOR YOUR RECORDS

For your assistance in reporting this unit in case of loss or theft, please record below the model number and serial number which are located on the rear of the unit.

Please retain this information.

Model number

Serial number

Date of purchase

Place of purchase

0010

IMPORTANT SAFETY INSTRUCTIONS (for Users in the U.S.A.)

- 1 Read Instructions** - All the safety and operating instructions should be read before the product is operated.
- 2 Retain Instructions** - The safety and operating instructions should be retained for future reference.
- 3 Heed Warnings** - All warnings on the product and in the operating instructions should be adhered to.
- 4 Follow Instructions** - All operating and use instructions should be followed.
- 5 Cleaning** - Unplug this product from the wall outlet before cleaning. Do not use liquid cleaners or aerosol cleaners. Use a damp cloth for cleaning.
- 6 Attachments** - Do not use attachments not recommended by the product manufacturer as they may cause hazards.
- 7 Water and Moisture** - Do not use this product near water - for example, near a bath tub, wash bowl, kitchen sink, or laundry tub; in a wet basement; or near a swimming pool; and the like.
- 8 Accessories** - Do not place this product on an unstable cart, stand, tripod, bracket, or table. The product may fall, causing serious injury to a child or adult, and serious damage to the product. Use only with a cart, stand, tripod, bracket, or table recommended by the manufacturer, or sold with the product. Any mounting of the product should follow the manufacturer's instructions, and should use a mounting accessory recommended by the manufacturer.
- 9** A product and cart combination should be moved with care. Quick stops, excessive force, and uneven surfaces may cause the product and cart combination to overturn.



- 10 Ventilation** - Slots and openings in the cabinet are provided for ventilation and to ensure reliable operation of the product and to protect it from overheating, and these openings must not be blocked or covered. The openings should never be blocked by placing the product on a bed, sofa, rug, or other similar surface. This product should not be placed in a built-in installation such as a bookcase or rack unless proper ventilation is provided or the manufacturer's instructions have been adhered to.
- 11 Power Sources** - This product should be operated only from the type of power source indicated on the marking label. If you are not sure of the type of power supply to your home, consult your product dealer or local power company. For products intended to operate from battery power, or other sources, refer to the operating instructions.
- 12 Grounding or Polarization** - This product may be equipped with a polarized alternating-current line plug (a plug having one blade wider than the other). This plug will fit into the power outlet only one way. This is a safety feature. If you are unable to insert the plug fully into the outlet, try reversing the plug. If the plug should still fail to fit, contact your electrician to replace your obsolete outlet. Do not defeat the safety purpose of the polarized plug.
Alternate Warnings - This product is equipped with a three-wire grounding-type plug, a plug having a third (grounding) pin. This plug will only fit into a grounding-type power outlet. This is a safety feature. If you are unable to insert the plug into the outlet, contact your electrician to replace your obsolete outlet. Do not defeat the safety purpose of the grounding-type plug.
- 13 Power-Cord Protection** - Power-supply cords should be routed so that they are not likely to be walked on or pinched by items placed upon or against them, paying particular attention to cords at plugs, convenience receptacles, and the point where they exit from the product.
- 14 Protective Attachment Plug** - The product is equipped with an attachment plug having overload protection. This is a safety feature. See Instruction Manual for replacement or resetting of protective device. If replacement of the plug is required, be sure the service technician has used a replacement plug specified by the manufacturer that has the same overload protection as the original plug.

0109

IMPORTANT SAFETY INSTRUCTIONS (for Users in the U.S.A.) (continued)

15 Outdoor Antenna Grounding - If an outside antenna or cable system is connected to the product, be sure the antenna or cable system is grounded so as to provide some protection against voltage surges and built-up static charges. Article 810 of the National Electrical Code, ANSI/NFPA 70, provides information with regard to proper grounding of the mast and supporting structure, grounding of the lead-in wire to an antenna discharge unit, size of grounding conductors, location of antenna-discharge unit, connection to grounding electrodes, and requirements for the grounding electrode.

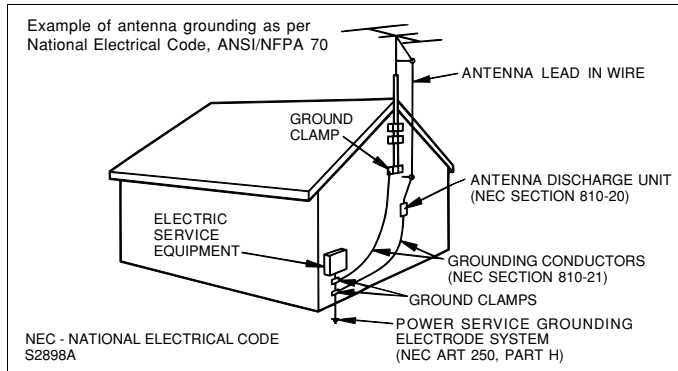

16 Lightning - For added protection for this product during a lightning storm, or when it is left unattended and unused for long periods of time, unplug it from the wall outlet and disconnect the antenna or cable system. This will prevent damage to the product due to lightning and power-line surges.

17 Power Lines - An outside antenna system should not be located in the vicinity of overhead power lines or other electric light or power circuits, or where it can fall into such power lines or circuits. When installing an outside antenna system, extreme care should be taken to keep from touching such power lines or circuits as contact with them might be fatal.

18 Overloading - Do not overload wall outlets, extension cords, or integral convenience receptacles as this can result in a risk of fire or electric shock.

19 Object and Liquid Entry - Never push objects of any kind into this product through openings as they may touch dangerous voltage points or short-out parts that could result in a fire or electric shock. Never spill liquid of any kind on the product.

20 Servicing - Do not attempt to service this product yourself as opening or removing covers may expose you to dangerous voltage or other hazards. Refer all servicing to qualified service personnel.

21 Damage Requiring Service - Unplug this product from the wall outlet and refer servicing to qualified service personnel under the following conditions:

- When the power-supply cord or plug is damaged,
- If liquid has been spilled, or objects have fallen into the product,
- If the product has been exposed to rain or water,
- If the product does not operate normally by following the operating instructions. Adjust only those controls that are covered by the operating instructions as an improper adjustment of other controls may result in damage and will often require extensive work by a qualified technician to restore the product to its normal operation,
- If the product has been dropped or damaged in any way, and
- When the product exhibits a distinct change in performance - this indicates a need for service.

22 Replacement Parts - When replacement parts are required, be sure the service technician has used replacement parts specified by the manufacturer or have the same characteristics as the original part. Unauthorized substitutions may result in fire, electric shock, or other hazards.

23 Safety Check - Upon completion of any service or repairs to this product, ask the service technician to perform safety checks to determine that the product is in proper operating condition.

24 Wall or Ceiling Mounting - The product should be mounted to a wall or ceiling only as recommended by the manufacturer.

25 Heat - The product should be situated away from heat sources such as radiators, heat registers, stoves, or other products (including amplifiers) that produce heat.

SPECIAL NOTES REMARQUES SPÉCIALES

Touch the metal outer case before you touch control buttons located on the front panel.

Toucher à l'enveloppe métallique externe avant d'agir sur les touches de commande situées sur la façade.

Manufactured under license from Digital Theater Systems, Inc. US Pat. No. 5,451,942, 5,956,674, 5,974,380, 5,978,762 and other world-wide patents issued and pending. "DTS" and "DTS Digital Surround" are registered trademarks of Digital Theater Systems, Inc. Copyright 1996, 2000 Digital Theater Systems, Inc. All Rights Reserved.

Fabriqué, sous licence de Digital Theater Systems, Inc. Les brevets US Pat. No. 5,451,942, 5,956,674, 5,974,380, 5,978,762 et autres internationaux délivrés et demandés. "DTS" et "DTS Digital Surround" sont des marques déposées de Digital Theater Systems, Inc. Copyright 1996, 2000 Digital Theater Systems. Tous droits réservés.

Manufactured under license from Dolby Laboratories. "Dolby", "Pro Logic" and the double-D symbol are trademarks of Dolby Laboratories. Confidential unpublished works. © 1992-1999 Dolby Laboratories. All rights reserved.

Fabriqué sous licence de Dolby Laboratories. «Dolby», «Pro Logic» et le symbole double D sont des marques de commerce de Dolby Laboratories. Œuvres confidentielles non publiées. © 1992-1999 Dolby Laboratories. Tous droits réservés.

ENERGY STAR® Program Information

As an ENERGY STAR® Partner, SHARP has determined that this product meets the ENERGY STAR® guidelines for energy efficiency. ENERGY STAR® is a U.S. registered mark.



WHY PURCHASE ENERGY STAR® LABELED PRODUCTS?

Many Electrical/Electronic Products use energy both when they are on and when they are off. Americans spend more than \$3 billion a year on energy consumed by home electronic products when they are not in use. The new ENERGY STAR® labeled models will reduce that energy "leakage" by up to 75 percent. Ultimately, this will mean more than \$1 billion a year in energy savings for consumers.

The energy savings will help reduce the burning of fossil fuels and the related carbon dioxide pollution that contributes to global warming. If every American family replaced their electronic equipment with ENERGY STAR® labeled models, it would reduce air pollution equivalent to eliminating more than two million cars.

By using ENERGY STAR® labeled products, you will save money on your electric bills and use less energy.

That makes good economic sense and it's good for our environment.

ENERGY STAR® is a U.S. registered mark.

0112

Introduction

Thank you for purchasing this SHARP product. To obtain the best performance from this product, please read this manual carefully. It will guide you in operating your SHARP product.

- SD-AT50 1-Bit Digital Home Theater and DX-AT50 DVD Player should be combined for use.
- SD-AT50 consists of AV control unit, Subwoofer/Amplifier unit, front speakers, a center speaker and surround speakers.
- DX-AT50 should be used exclusively with SD-AT50. All accessories are packaged in SD-AT50.
The remote control works for both products.
Refer to this operation manual for DX-AT50 operations.

Contents

	Page		Page
■ General Information		■ Advanced Disc Features	
Accessories	3	Basic operation	
Precautions	4	To locate the beginning of a chapter (track) (skip)	29
Description of discs	5	Fast forward/Fast reverse (search)	29
Controls and indicators	6 - 10	To start playback from the desired point (direct play)	30
■ Preparation for Use		Still picture/Frame advance	30
System connections	11, 12	Slow-motion play	30
Antenna connection	13	Useful features	
TV connection	13 - 15	To play in random order (random play)	31
System installation	15, 16	To play in the desired order (programmed playback)	31
Remote control	17	To play repeatedly (repeat play)	32
General control	18	To play the contents between the specified points repeatedly (A-B repeat) ..	32
Changing the initial setting of DVD	19 - 22	To select a title from the top menu of the disc	32
Language code list for disc language	23	MP3 disc operation	
Setting the clock	24	MP3 disc playback	33
■ Basic Operation		Various settings	
Listening to the radio	25	To change the subtitle language	34
Listening to the memorized station	26	To change the audio language (audio output)	34
Playing a disc	27, 28	To change the angle	34
		To brighten an image (black level setting)	35
		To zoom in on an image (zoom)	35
		To change the display on TV screen	36
		To set on the disc menu	36
		DVD mode operation indicators	36

	Page
■ Advanced Features	
Enjoy the surround sound (sound mode)	37 - 39
Changing the registration in the remote control	40
Speaker settings	41, 42
Timer and sleep operation	43 - 45
Audio connection of other equipment	46
Operating the connected TV	47

■ References

Error indicators and warnings	48
Troubleshooting chart	49, 50
Maintenance	51
Optional accessories	51
Specifications	51, 52

Copyright Information:

- Unauthorized copying, broadcast, public display, transmission, public performance and rental (regardless of whether or not such activities are for profit) of disc contents are prohibited by law.
- This device is equipped with copy protection technology that causes substantial degradation of images when the contents of a disc are copied to video tape.
- This device is protected by U. S. patents and other intellectual property rights, the copyright for which belongs to Macrovision Corporation. The use of Macrovision's copy protection technology in the device is authorized by Macrovision and is intended for home use only, unless otherwise authorized in writing by Macrovision. Reverse engineering or disassembly is prohibited.

Icons used in this operation manual

Some functions may not be available depending on discs. The following icons indicate the discs that can be used in the section.

 ... Indicates DVDs.





 ... Indicates audio CDs.

 ... Indicates CD-R/RW with MP3 recording.

- Some operations may not be performed depending on discs even if they are described in this manual.
- During operation, "Ⓢ" may be displayed on the screen. This means that the operations described in this manual are prohibited by the disc.

■ Types of playable discs

The DVD player can play back discs bearing any of the following marks:

Disc type	Disc contents	Disc size
DVD Video Disc for NTSC system 	Audio and video (movies)	5" (12 cm) 3" (8 cm)
Or DVD-R/DVD-RW recorded in video mode (*1)		
Audio CD 	Audio	5" (12 cm) 3" (8 cm)
Or CDV (*2)		
Audio CD-R/CD-RW (*3)  	Audio	5" (12 cm) 3" (8 cm)
Or CD-R/CD-RW recorded in MP3 format (*4)		

(*1): The DVD-R/DVD-RW may not be played back due to properties and scratches of the disc, dirty optical pickup lens, etc.

(*2): Only the audio on the CDV can be played.





(*3): The CD-R/CD-RW may not be played back properly depending on the recording equipment or the disc.

(*4): If the sampling frequency is 44.1 or 48.1 kHz and the fixed bit rate is 128 kbps or higher, MPEG 1 Audio Layer3 (MP3) files can be played. However, some of them may not be played depending on their conditions or format.

- For unplayable discs, see page 5.

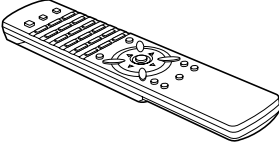
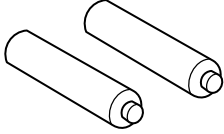
Accessories

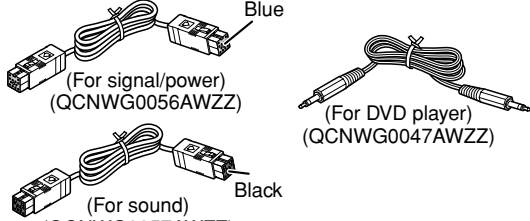
Please confirm that the following accessories are included.

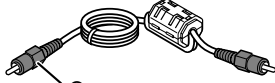
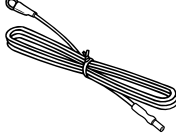
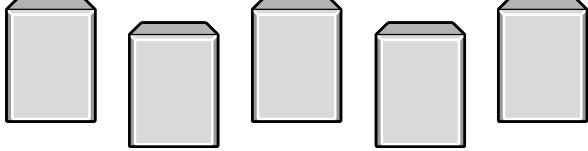
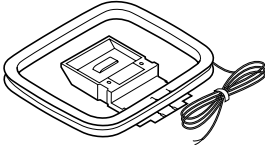
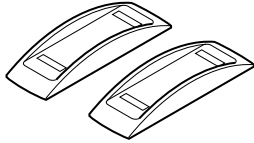
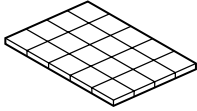
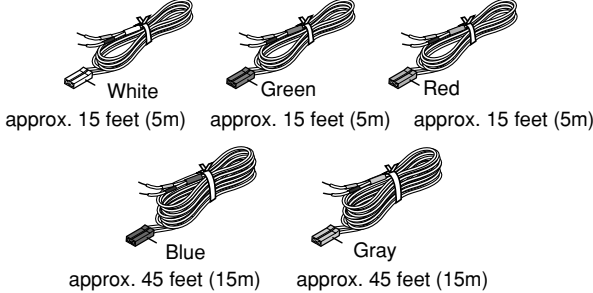
 <p>Remote control × 1 (RRMCG0354AWSA)</p>	 <p>"AAA" size battery (UM-4, R03, HP-16 or similar) × 2 (UBATU0111AFZZ)</p>	 <p>AC power cord × 1 (QACCD0031AWZZ)</p>	 <p>System connection cable × 3</p>
 <p>Video cable × 1 (QCNQG0055AWZZ)</p>	 <p>Digital audio cable × 1 (QCNWG0048AWZZ)</p>	 <p>FM antenna × 1 (92LFANT1535A)</p>	 <p>Satellite speaker × 5 (GBOXS0099AWM2)</p>
 <p>AM loop antenna × 1 (QANTL0012AWZZ)</p>	 <p>Stand × 2 (HOLD4809ASY1)</p>	 <p>Antislip speaker cushion × 1 sheet (20 pcs.) (PCUSG0129AWSA)</p>	 <p>Speaker connection cord × 5 (QCNWG0052AWZZ)</p>

Note:

Only the above accessories are included.

Precautions

■ General

- Please ensure that the subwoofer/amplifier unit is positioned in a well-ventilated area and that there is at least 4" (10 cm) of free space along the sides and back. There must also be a minimum of 6" (15 cm) of free space on the top of the subwoofer/amplifier unit.

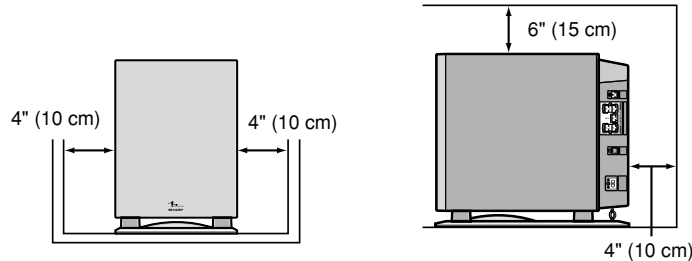

- Use the system on a firm, level surface free from vibration.
- Keep the system away from direct sunlight, strong magnetic fields, excessive dust, humidity and electronic/electrical equipment (home computers, facsimiles, etc.) which generates electrical noise.
- Do not place anything on top of the components.
- Do not expose the system to moisture, to temperatures higher than 140°F (60°C) or to extremely low temperatures.
- If your system does not work properly, disconnect the AC power cord from the AC outlet. Plug the AC power cord back in, and then turn on your system.
- In case of an electrical storm, unplug the DVD player and the subwoofer/amplifier unit for safety.
- Hold the AC power plug by the head when removing it from the AC outlet, as pulling the cord can damage internal wires.
- Do not remove the outer cover, as this may result in electric shock. Refer internal service to your local SHARP service facility.
- This system should only be used within the range of 41°F - 95°F (5°C - 35°C).

Warning:

The voltage used must be the same as that specified on this system. Using this product with a higher voltage other than that which is specified is dangerous and may result in a fire or other type of accident causing damage. SHARP will not be held responsible for any damage resulting from use of this system with a voltage other than that which is specified.

Caution:

- This subwoofer/amplifier unit is fitted with a cooling fan at the rear for improved cooling. Do not cover the opening in this section with any obstacles.

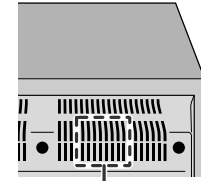

Cooling fan

- During use the DVD player and the subwoofer/amplifier unit will get warm, do not touch warm areas of the DVD player and the subwoofer/amplifier unit for prolonged periods to avoid damage to you or the DVD player and the subwoofer/amplifier unit.
- This system is equipped with special function which protects amplifier circuit from damages. When it is activated, sound switch is turned off. In this case, set the DVD player and the AV control unit to the stand-by mode and turn it on again.

■ Volume control

The sound level at a given volume setting depends on speaker efficiency, location and various other factors. It is advisable to avoid exposure to high volume levels, which occurs while turning the system on with the volume control setting up high, or while continually listening at high volumes.

■ Care of DVD/CD discs

DVD/CD discs are fairly resistant to damage, however mistracking can occur due to an accumulation of dirt on the disc surface. Follow the guidelines below for maximum enjoyment from your DVD/CD collection and player.

- Do not write on either side of the disc, particularly the non-label side from which signals are read. Do not mark this surface.
- Keep your discs away from direct sunlight, heat, and excessive moisture.
- Always hold the DVD/CDs by the edges. Fingerprints, dirt, or water on the DVD/CDs can cause noise or mistracking. If a DVD/CD is dirty or does not play properly, clean it with a soft, dry cloth, wiping straight out from the center, along the radius.

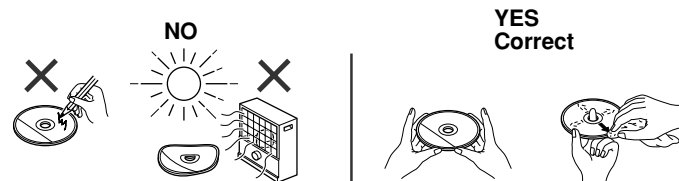

Description of discs

■ Discs that cannot be played

- DVDs without the region number "1" or "ALL".
- DVDs with PAL system
- DVDs with SECAM system
- DVDs with MPEG sound
- DVD-ROM
- DVD-RAM
- DVD-Audio
- The discs above cannot be played at all, or no sound is heard although images appear on the screen or vice versa.
- Faulty playback may damage the speakers and can have an adverse effect on your hearing when played at high volume settings.
- **This DVD player adopts the NTSC system. Discs that were made in foreign countries may not be played back. Check the recording system before purchasing discs.**
- You cannot play illegally produced discs.

Notes:

- A disc that has scratches or fingerprints on it may not play properly. Refer to "Care of DVD/CD discs (page 4)" and clean the disc.
- Do not play the discs of special shapes (heart or octagon shaped) as they can be ejected from the machine while rotating and cause injury.

■ Title, chapter and track

DVDs are divided into "titles" and "chapters". If the disc has more than one movie on it, each movie is a separate "title". "Chapters" are subdivisions of titles.

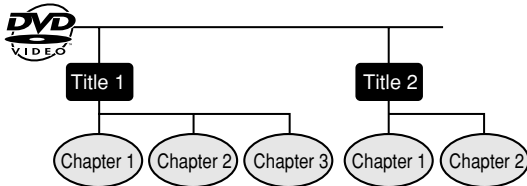

The audio CDs consist of "tracks".
A "track" is each tune on an audio CD.

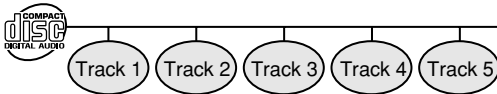

Note:

Title, chapter, or track numbers may not be recorded on some discs.

■ Icons used on DVD discs

Check the icons of the DVD case before playing your discs.

Display	Description
Region number (playable area number) 	DVD discs are programmed with region numbers indicating countries in which they can be played. This system can play discs with region number "1" or "ALL".
Format recorded on the DVD 4:3	Recorded in 4:3. To adopt the video format to the connected TVs ("wide-screen TV" or "4:3 size TV").
	You can enjoy wide images on a wide-screen TV, and letterbox size images on the 4:3 size TV.
	You can enjoy wide images on a wide-screen TV, and sides-cut 4:3 images on the 4:3 size TV.
Type of subtitles recorded Example: 1: English 2: Japanese	<u>Recorded subtitle language.</u> A desired language can be selected with the SUBTITLE button.
Number of camera angles 	<u>Number of angles recorded on the DVD.</u> A desired angle can be selected with the ANGLE button.
Number of audio track and audio recording system Example: 1: Original <English> (DTS 5.1 Surround) 2: Japanese (Dolby Digital 5.1 Surround)	The number of audio tracks and audio recording system are indicated. <ul style="list-style-type: none"> ● The audio recorded on the DVD can be switched by using the AUDIO button. ● Audio and recording system vary depending on the DVD. Check them in the DVD's manual.

Controls and indicators

Display

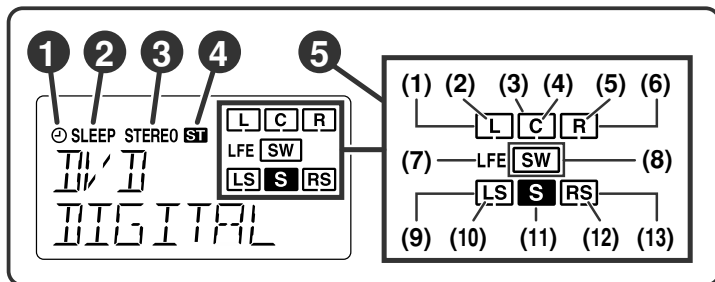

Front

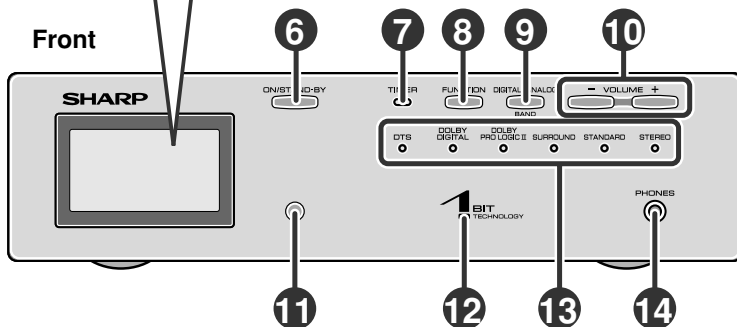

Back

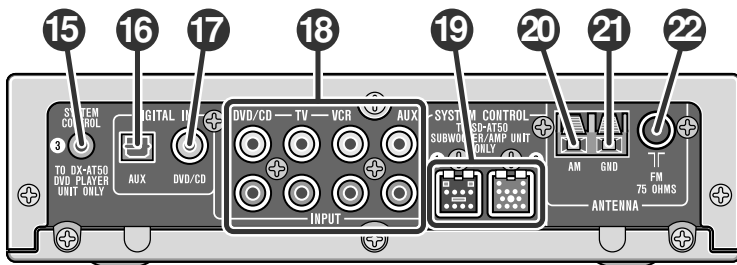

■ AV Control Unit

1. Timer Play Indicator
2. Sleep Indicator
3. FM Stereo Mode Indicator
4. FM Stereo Receiving Indicator
5. Audio Signal Indicators/Speaker Indicators

- | | |
|------------------------------------|---|
| (1) Left Front Speaker Indicator | (8) Subwoofer Indicator |
| (2) Front Left Signal Indicator | (9) Left Surround Speaker Indicator |
| (3) Center Speaker Indicator | (10) Surround Left Signal Indicator |
| (4) Center Signal Indicator | (11) Surround Monaural Signal Indicator |
| (5) Front Right Signal Indicator | (12) Surround Right Signal Indicator |
| (6) Right Front Speaker Indicator | (13) Right Surround Speaker Indicator |
| (7) Low Frequency Effect Indicator | |

	Reference page
6. On/Stand-by Button	18, 50
7. Timer Set Indicator	44
8. Function Button	25, 27, 47
9. Digital/Analog/Band Select Button	25, 47
10. Volume Up and Down Buttons	18
11. Remote Sensor	17
12. Power Indicator	18
13. Sound Mode Indicators	38, 39
14. Headphone Jack	28
15. System Connection Jack (to DVD player)	11
16. Audio Digital Input Jack	46
17. Coaxial Digital Audio Input Jack	11
18. Audio Input Jacks	11, 15, 46
19. System Connection Jacks (to subwoofer/amplifier unit)	11
20. AM Loop Antenna Terminal	13
21. Antenna Ground Terminal	13
22. FM 75 Ohms Antenna Jack	13

Controls and indicators (continued)

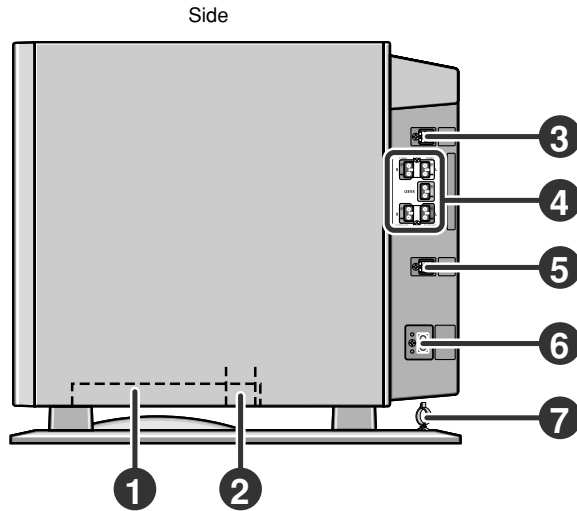

■ Subwoofer/Amplifier Unit

Reference page

1. Subwoofer
2. **Bass Reflex Duct**
3. **System Connection Jack (to AV control unit)**11
4. **Speaker Terminals**12
5. **System Connection Jack (to AV control unit)**11
6. **AC Power Input Jack**18
7. **Cord Holder**12

■ Satellite speaker × 5

Front speaker × 2: magnetically shielded

Center speaker × 1: magnetically shielded

Surround speaker × 2: magnetically shielded

Reference page

1. Speaker
2. **Speaker Terminals**12
3. **Mounting Holes for Stand or Bracket (Optionally available)**16

Using antislip speaker cushions:

You can install satellite speakers either vertically or horizontally.

Affix the cushions (supplied) to the bottom of the speakers to prevent them from sliding or falling due to vibration.

(Vertical position)

(Horizontal position)

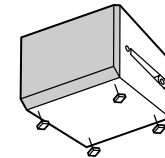
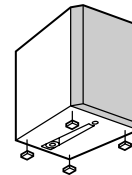
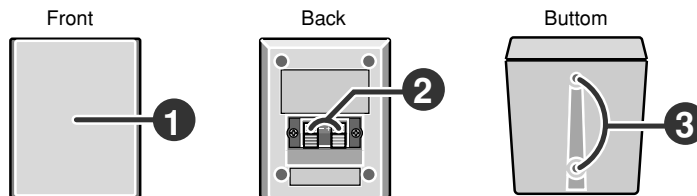

A sheet of speaker cushions (20 pcs.) is supplied with this product. Use 4 cushions per speaker.

Display

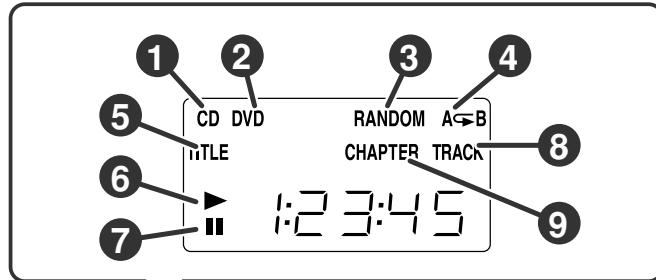

Front

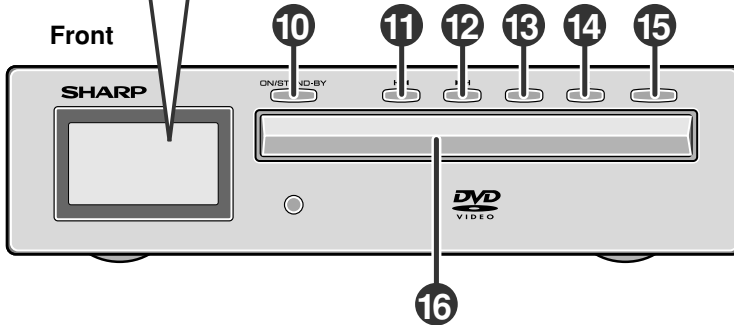

Back

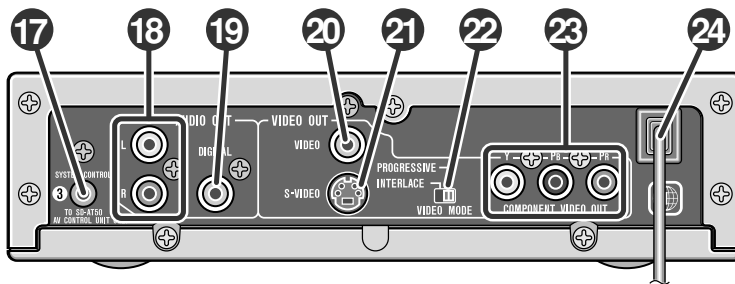

■ DVD Player

- 1. CD Indicator
- 2. DVD Indicator
- 3. CD/MP3 Disc Random Play Indicator
- 4. Disc Repeat or Disc A - B Repeat Indicator
- 5. DVD Title Indicator
- 6. Disc Play Indicator
- 7. Disc Pause Indicator
- 8. CD Track Indicator
- 9. DVD Chapter Indicator

Reference page

10. <u>On/Stand-by Button</u>	18
11. <u>DVD Chapter Skip or CD/MP3 Disc Track Down Button</u>	29, 33
12. <u>DVD Chapter Skip or CD/MP3 Disc Track Up Button</u>	29, 33
13. <u>Disc Stop Button</u>	28
14. <u>Disc Play Button</u>	27, 28
15. <u>Disc Tray Open/Close Button</u>	27
16. <u>Disc Tray</u>	27
17. <u>System Connection Jack (to AV control unit)</u>	11
18. <u>Audio Output Jacks</u>	11
19. <u>Coaxial Digital Audio Output Jack</u>	11
20. <u>Video Output Jack</u>	13
21. <u>S-video Output Jack</u>	14
22. <u>DVD Video Mode Selector Switch</u>	14
23. <u>Component Video Output Jacks</u>	14
24. <u>AC Power Cord</u>	18

Controls and indicators (continued)

[Front]

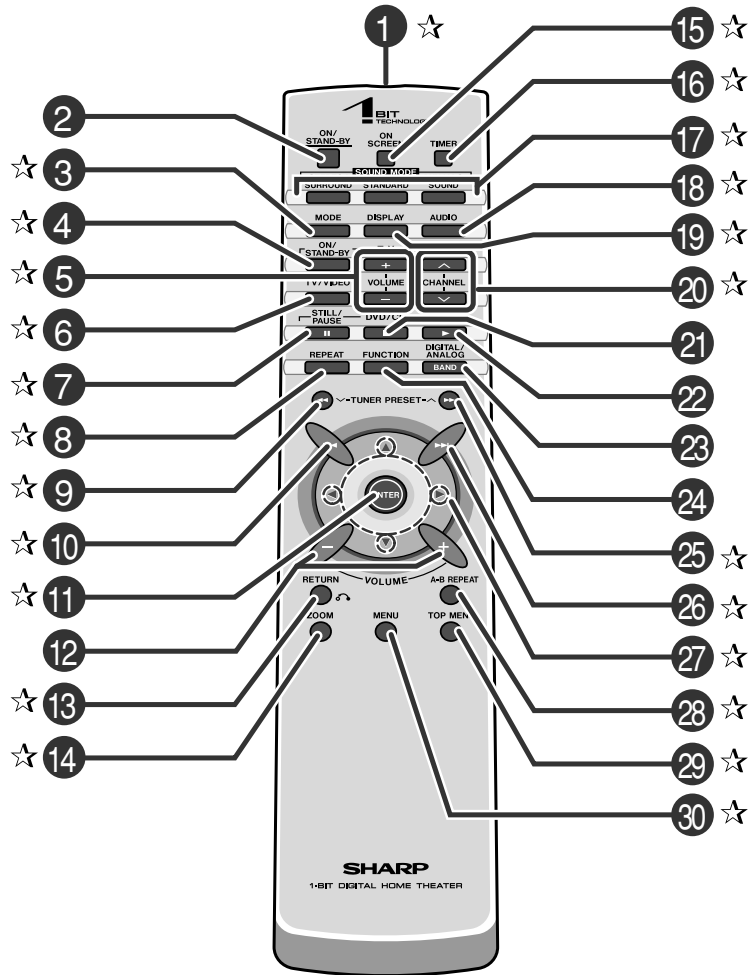

■ Remote control

	Reference page
1. Remote Control Transmitter17
2. On/Stand-by Button17
3. CD/MP3 Disc Play Mode Select Button31
4. TV On/Stand-by Button47
5. TV Volume Up and Down Buttons47
6. TV/VIDEO Button47
7. DVD Frame Advance, Disc Pause Button28, 30
8. Disc Repeat Button32
9. Disc Fast Reverse, Tuner Preset Down Button26, 29
10. DVD Chapter Skip, CD/MP3 Disc Track Down or Tuning Down Button25, 29, 33
11. Enter Button24, 33, 43
12. Volume Up and Down Buttons18
13. Return Button19, 31, 42
14. DVD Zoom Button35
15. TV Display Select Button36
16. Timer Button24, 43
17. Sound Mode Select Buttons39
18. Audio Mode Select Button34
19. Display Select Button18
20. TV Channel Select Buttons47
21. Disc Stop Button27, 28
22. Disc Play Button27, 28
23. Digital/Analog/Band Select Button25, 47
24. Function Button25, 27, 47
25. Disc Fast Forward, Tuner Preset Up Button26, 29
26. DVD Chapter Skip, CD/MP3 Disc Track Up or Tuning Up Button25, 29, 33
27. Cursor Button24, 33, 43
28. Disc A - B Repeat Button32
29. DVD Top Menu Button32
30. DVD Menu Button32

Buttons with "★" mark in the illustration can be operated on the remote control only.

[Back]

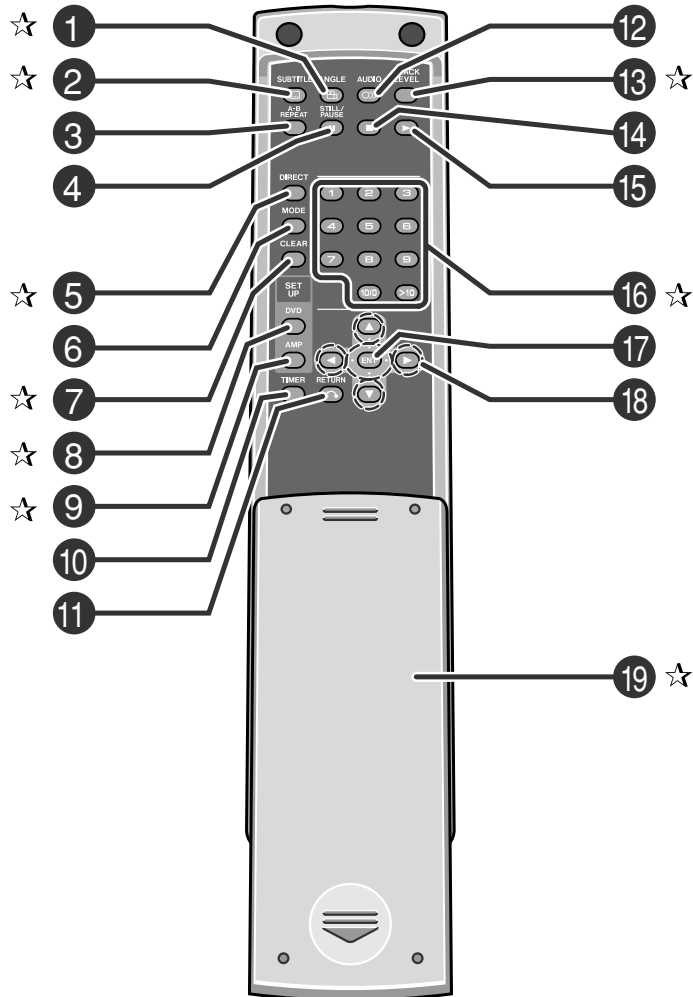

■ Remote control

	Reference page
1. DVD Angle Button	34
2. DVD Subtitle Button	34
3. Disc A - B Repeat Button	32
4. DVD Frame Advance, Disc Pause Button	28, 30
5. Direct Button	30
6. CD/MP3 Disc Play Mode Select Button	31
7. Clear Button	26, 30
8. DVD Initial Setting Button	19
9. Amplifier Initial Setting Button	41
10. Timer Button	24, 43
11. Return Button	19, 31, 42
12. Audio Mode Select Button	34
13. Black Level Select Button	35
14. Disc Stop Button	28
15. Disc Play Button	27, 28
16. Direct Number Buttons	26, 30, 40
17. Enter Button	24, 33, 43
18. Cursor Buttons	24, 33, 43
19. Sliding Cover	17

Buttons with "*" mark in the illustration can be operated on the back of the remote control.

System connections

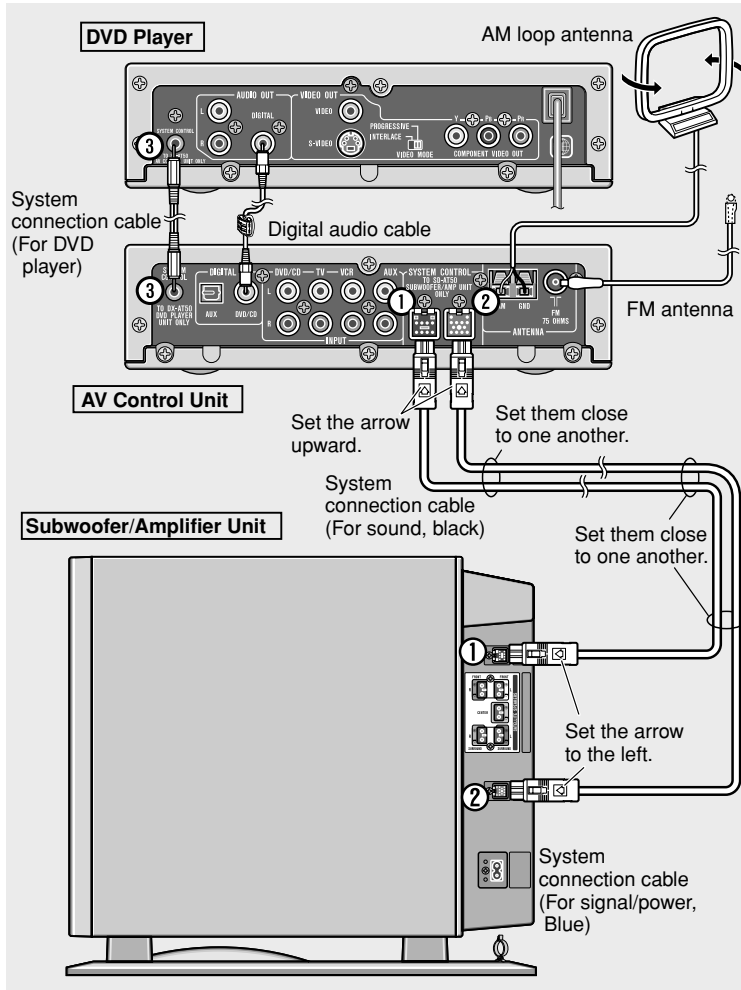

■ Connecting the units

Connect the DVD player, AV control unit and subwoofer/amplifier unit as follows.

Connecting units		Cord	
AV control unit ①	↔ Subwoofer/Amplifier unit ①	System connection cable (For sound, Black)	
AV control unit ②	↔ Subwoofer/Amplifier unit ②	System connection cable (For signal/power, Blue)	
AV control unit ③	↔ DVD player ③	System connection cable (For DVD player)	
AV control unit DIGITAL IN DVD/CD	↔ DVD player AUDIO OUT DIGITAL ☆	Digital audio cable ☆ (For digital signal)	
AV control unit DVD/CD INPUT L R	↔ DVD player AUDIO OUT L R ☆	Commercially available RCA cord ☆ (For analog signal)	

☆ Connect either an audio digital cable or commercially available RCA cord. Press the **DIGITAL/ANALOG** button to switch between digital and analog signals according to the connection.

Caution:

- Make sure to connect the system after unplugging the DVD player and the subwoofer/amplifier unit.
- Put the 2 system connection cables (for sound and signal/power) together. If not, noises may be heard.

To unplug the system connection cable:

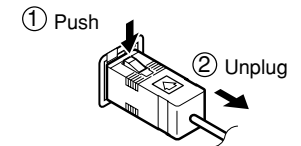

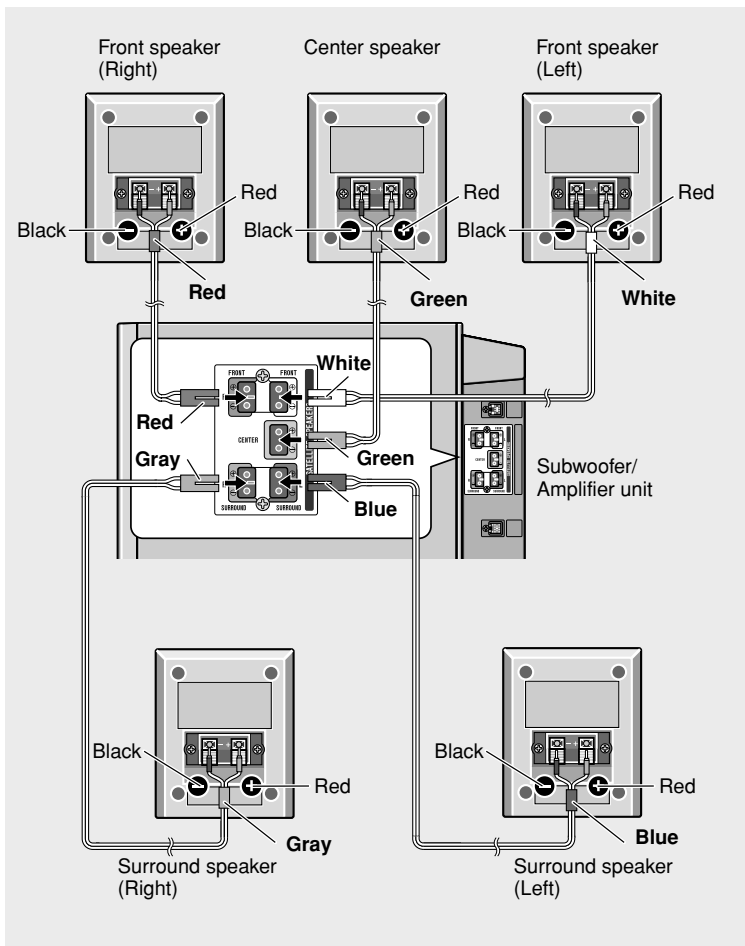

All satellite speakers provide the same performance.
Their positions can be exchanged with one another.

■ Connecting the satellite speakers

Insert the speaker plugs to the subwoofer/amplifier unit according to the color coding. Connect the speaker cords to the satellite speakers first and then to the subwoofer/amplifier unit.

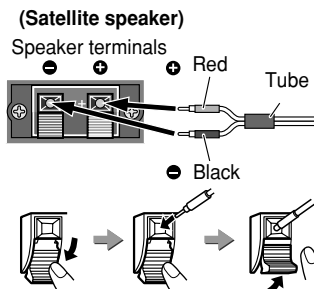

(Subwoofer/amplifier unit)

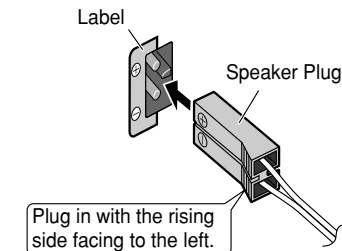

Caution:

- Make sure to connect the speakers after unplugging the DVD player and the subwoofer/amplifier unit.
- Insert the speaker plug fully with the rising side facing to the left.
- Hold the speaker plug when removing it from the subwoofer/amplifier unit. Pulling the cord may cause malfunction to the subwoofer/amplifier unit.
- Do not mistake the \oplus and \ominus , and right and left terminals of the speaker cords. (The right speaker is placed on the right when you face the system. See page 16.)
- **Never short-circuit the speaker cords. If the speaker cords are short-circuited, the protection circuit is activated and the power is turned off. In such a case, check that the cords are properly connected before turning the power on again.**

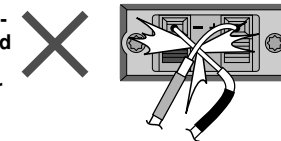

- Only the supplied speakers should be used with this product.
- Do not stand or sit on the speakers. You may be injured.

Binding cords:

Tie the cords connected to the subwoofer/amplifier unit with a cord holder.

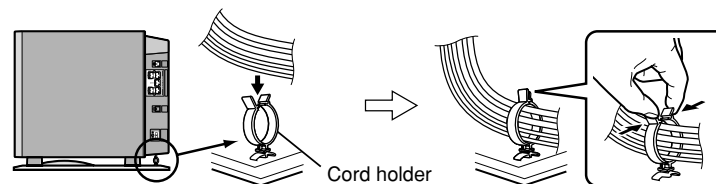

Antenna connection

Supplied FM antenna:

Connect the FM antenna wire to the FM 75 OHMS jack and position the FM antenna wire in the direction where the strongest signal can be received.

Supplied AM loop antenna:

Connect the AM loop antenna wire to the AM and GND terminals. Position the AM loop antenna for optimum reception. Place the AM loop antenna on a shelf, etc., or attach it to a stand or a wall with screws (not supplied).

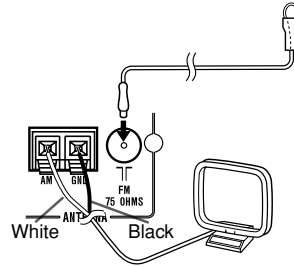

Notes:

- Placing the antenna on the system or near the AC power cord may cause noise pickup. Place the antenna away from the system for better reception.
- When static is still heard even after adjusting the position of the AM loop antenna, try reversing the wire connections.

Installing the AM loop antenna:

< Assembling >

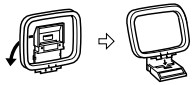

< Attaching to the wall >

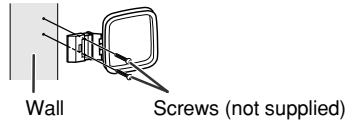

Outdoor FM or AM antenna:

Use an outdoor FM or AM antenna if you require better reception. Consult your dealer.

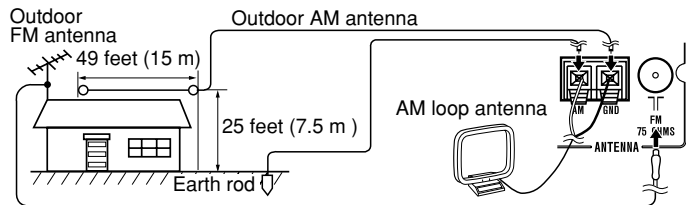

Note:

When using an outdoor AM antenna, be sure to keep the wire of the AM loop antenna connected.

TV connection

Caution:

Before connecting the TV, turn off all the equipment.

■ Connecting to TV with video cable

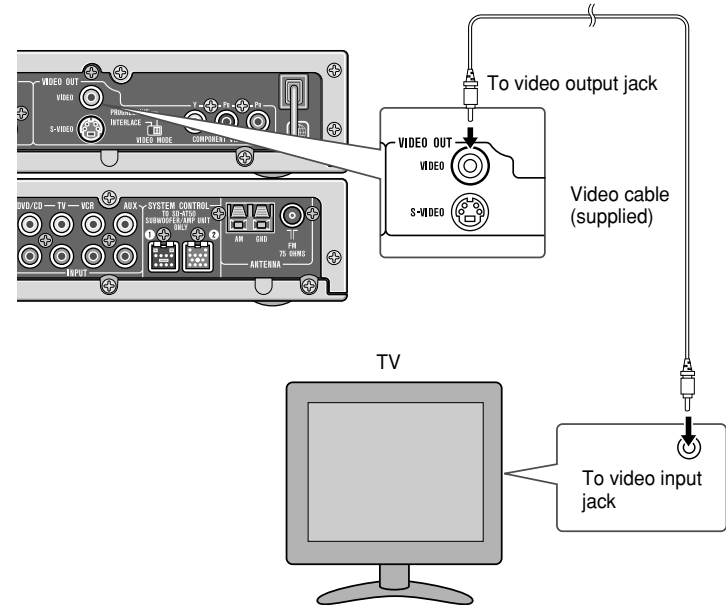

Notes:

- Change the TV input in accordance with the connected jack.
- Do not connect other equipment between the TV and the DVD player. If they are connected via a VCR, pictures may be distorted.

This DVD player has two jacks to output images in addition to the VIDEO OUT jack. To enjoy clearer DVD images, connect your TV to these jacks.

■ Connecting to TV with S-video cable

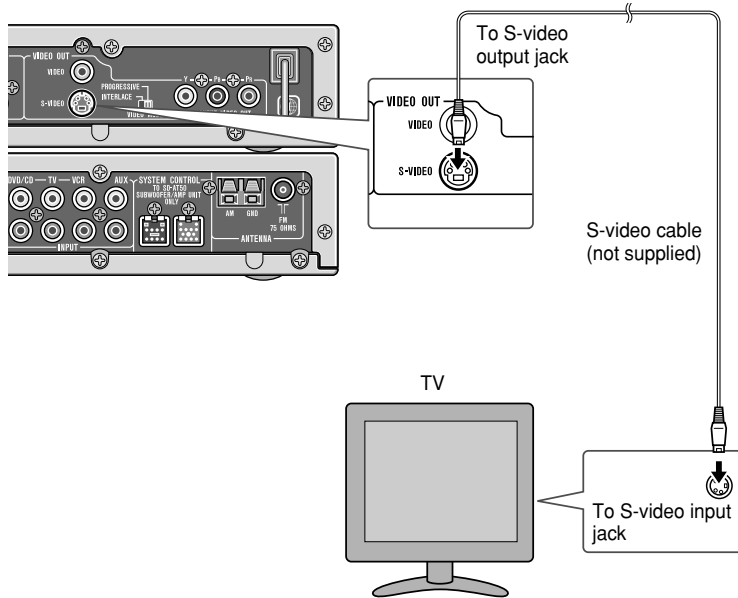

Caution:

When the video and S-video cables are both connected, the images from the S-video input jack appears on your TV.

■ Connecting to TV with Component video cable

If the connecting TV provides progressive scanning, set the video mode selector switch to PROGRESSIVE to enjoy high-density images. If not, switch back to INTERLACE.

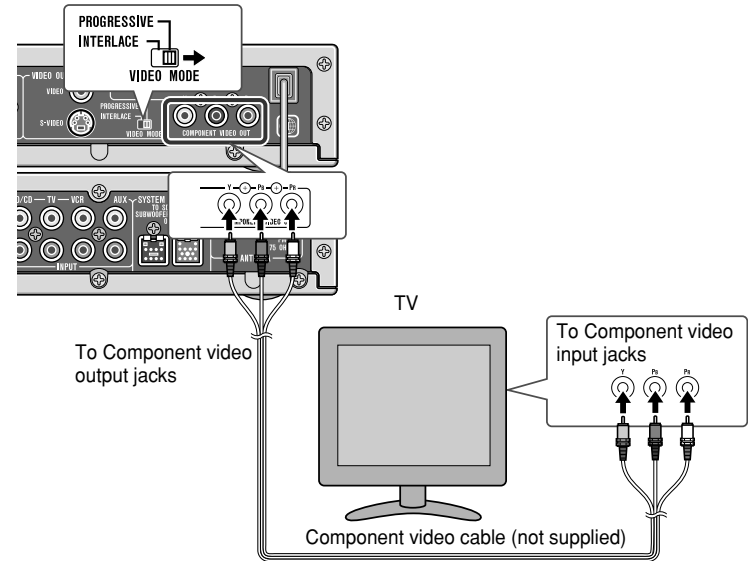

Notes:

- If your TV has different indications for the component video inputs (Y, CB and CR or Y, B-Y and P-Y), connect jacks with its matching color.
- Do not connect to a component video input jack designed for the high-vision system, which is not DVD-compatible (the images may be distorted or not appear).

What is progressive scanning?

The conventional TV system displays 30 frames of still images per second to complete sequential movement (interlaced scanning). Whereas, progressive scanning displays one frame every 1/60th of a second (60 frames per second) to realize less-flicker, high-density images.

TV connection (continued)

To listen to the TV sound via the speakers of this system:

Using the audio cable, you can listen to the TV sound with this system.

(The audio cable is not supplied. Purchase a commercially available cable.)

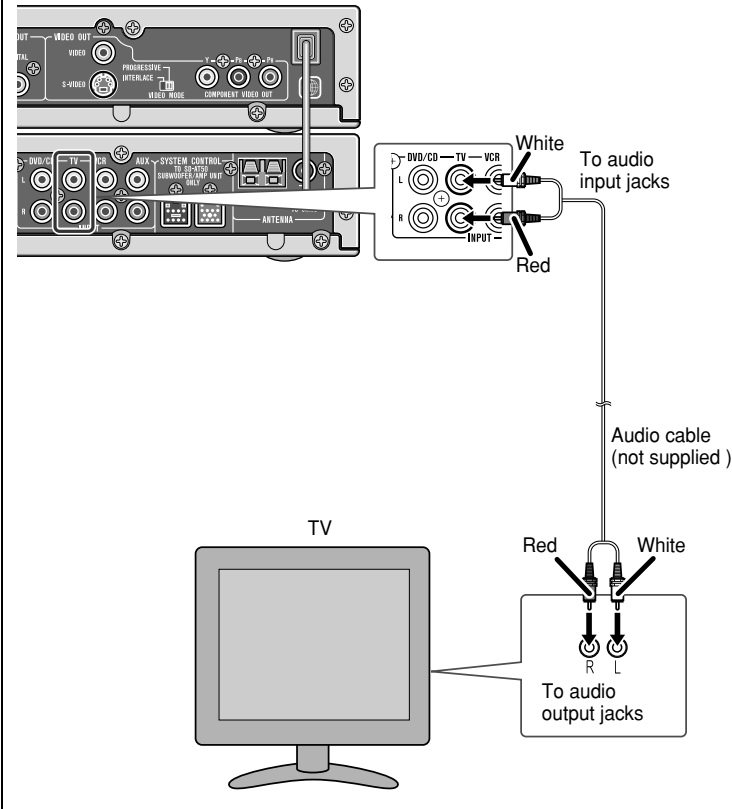

System installation

■ Installing AV control unit and DVD player

You can place one unit on top of the other or place them separately in a horizontal position.



With the supplied stands, the unit can be installed vertically.

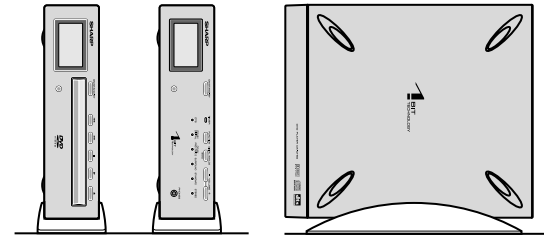

Caution:

When installing the DVD player vertically, bring the display window to the upper side.
When set vertically, an 3" (8 cm) disc cannot be played.

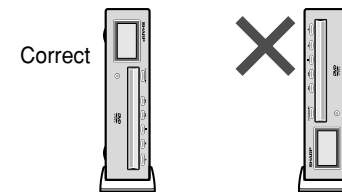

Note:

- If the display window of the DVD player is placed on the lower side, a disc may fall or may not be ejected.
- Avoid changing the DVD player installation (vertical or horizontal) while a disc is playing. The disc may be scratched.

■ Placing the speaker system

The best surround effect will be achieved by placing each speaker at the same distance from the listening position.

It is recommended to arrange the speakers as shown below.

Identify each speaker by the tube color.

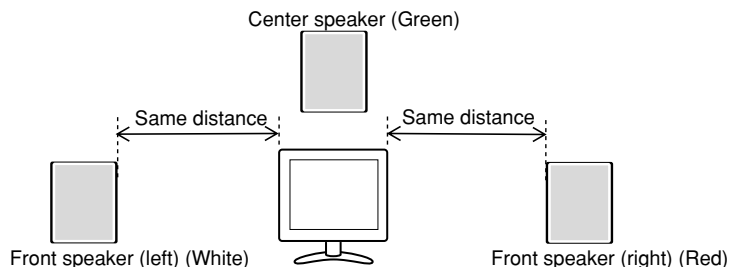
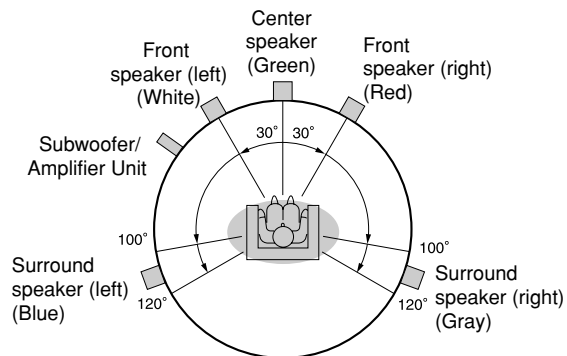

Notes:

- Place the TV halfway between the front speakers.
- It is recommended that the center speaker be placed near the television.
- Place the surround speakers at a position just above the height of your ears.
- Set the subwoofer/amplifier unit on a stable, sturdy floor.
- If speakers cannot be placed at equal distances, refer to "Speaker delay setting". (See page 41.)
- The speaker grille is not removable.

The speaker stands and speaker wall brackets are optionally available. (See page 51.) Refer to their manuals for assembly.

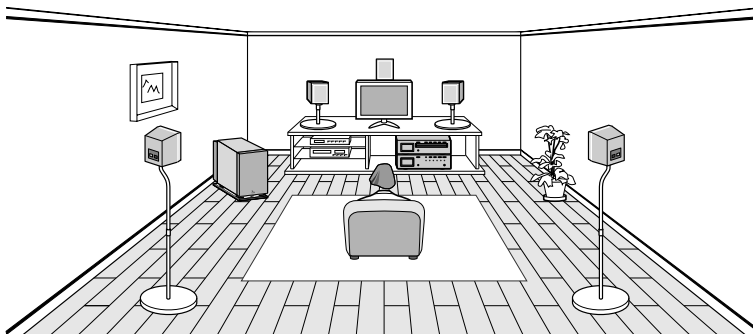

The speakers may be placed beside or near the TV as they are magnetically shielded. However, color variation may occur, depending on the type of the TV.

If color variation occurs...

Turn off the TV (from the power switch).

After 15 - 30 minutes, turn the TV on again.

If the color variation is still present...

Move the speakers further away from the TV.

Refer to the user's manual of the TV for details.

Caution:

When moving the subwoofer/amplifier unit, be careful not to touch the speaker net located near bottom. Be sure to hold it by the bottom to avoid subwoofer breakage.

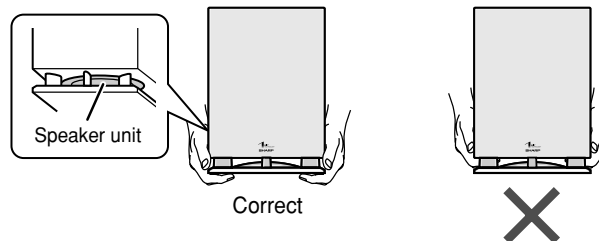

Remote control

■ Battery installation

- 1 Remove the battery cover.
- 2 Insert the batteries according to the direction indicated in the battery compartment.
When inserting or removing the batteries, push them toward the ⊖ battery terminals.
- 3 Replace the cover.

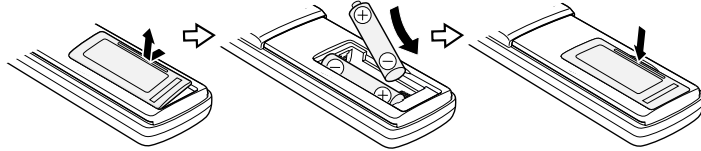

Precautions for battery use:

- Replace all old batteries with new ones at the same time.
- Do not mix old and new batteries.
- Remove the batteries if the system will not be used for long periods of time. This will prevent potential damage due to battery leakage.

Caution:

- Do not use rechargeable batteries (nickel-cadmium battery, etc.).
- Installing the batteries incorrectly may cause the system to malfunction.

Notes concerning use:

- Replace the batteries if the operating distance is reduced or if the operation becomes erratic. Purchase 2 "AAA" size batteries (UM-4, R03, HP-16 or similar).
- Periodically clean the transmitter on the remote control and the sensor on the unit with a soft cloth.
- Exposing the sensor on the AV control unit to strong light may interfere with operation. Change the lighting or the direction of the AV control unit.
- Keep the remote control away from moisture, heat, shock, and vibrations.

■ Test of the remote control

Check the remote control after checking all connections have been made correctly. (See pages 11 - 18.)

Point the remote control directly at the remote sensor on the AV control unit. Likewise, point the remote control at the AV control unit to operate the DVD player unit.

The remote control can be used within the range shown below:

Press the ON/STAND-BY button. Does the power turn on? Now, you can enjoy your system.

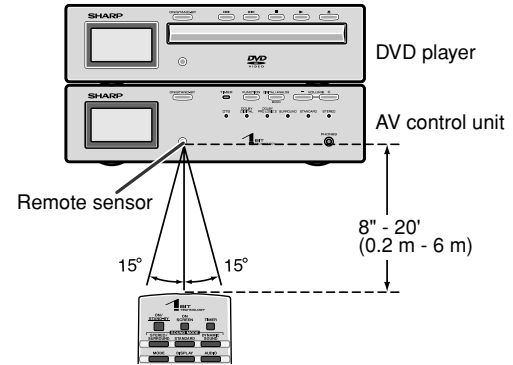

■ How to open the sliding cover

This remote control has buttons on its front and back. To use the buttons on the back, open the sliding cover.

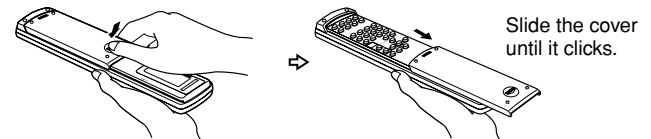

Notes:

- **When operating the buttons on the back of the remote control, be careful not to press the buttons on the front side. The system may malfunction.**
- Close the sliding cover on the back while using the buttons on the front side.

General control

■ Connecting the AC power cord

Subwoofer/amplifier unit

After checking all the connections, connect the AC power cord to the AC power input jack, then the subwoofer/amplifier unit into the AC outlet.

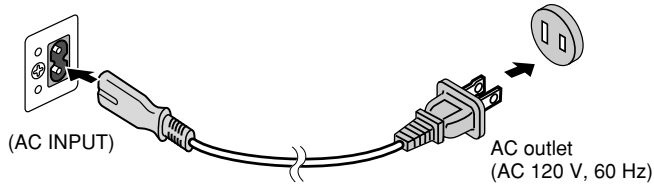

DVD Player

After checking all the connections, plug the DVD player into the AC outlet.

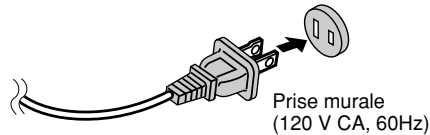

Notes:

- The power is supplied to the AV control unit by the subwoofer/amplifier unit. The AV control unit is not equipped with a power cord.
- Never use a power cord other than the one supplied. Otherwise, a malfunction or an accident may occur.
- Unplug the DVD player and the subwoofer/amplifier unit if they will not be used for a prolonged period of time.

CAUTION:
TO PREVENT ELECTRIC SHOCK, MATCH WIDE BLADE OF PLUG TO WIDE SLOT, FULLY INSERT.

■ To turn the power on

Press the ON/STAND-BY button.

The power indicator lights up.

If the power does not turn on, check if the power cord is plugged in properly.

Note:

When the ON/STAND-BY button on the remote control is pressed, the power on both units turns on.

■ Volume control

Press the VOLUME + button to increase the volume and the VOLUME - button for decreasing.

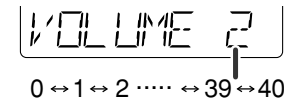

■ To change the display brightness (2 levels)

You can switch the display brightness by holding down the DISPLAY button on the remote control for 2 seconds or more.



Caution:

The display brightness depends on the setting of "PANEL DISPLAY" of "Changing the initial setting of DVD". (See page 20.)

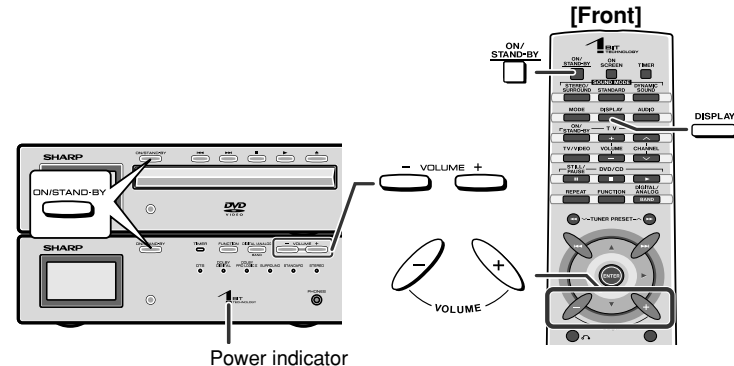

Changing the initial setting of DVD

Turn on the TV, and switch the input to the "VIDEO 1" or "VIDEO 2" etc. accordingly.

A new setting will be retained even if the DVD player is set to the stand-by mode. If you want to restore or change the setting, reset it.

[Back]

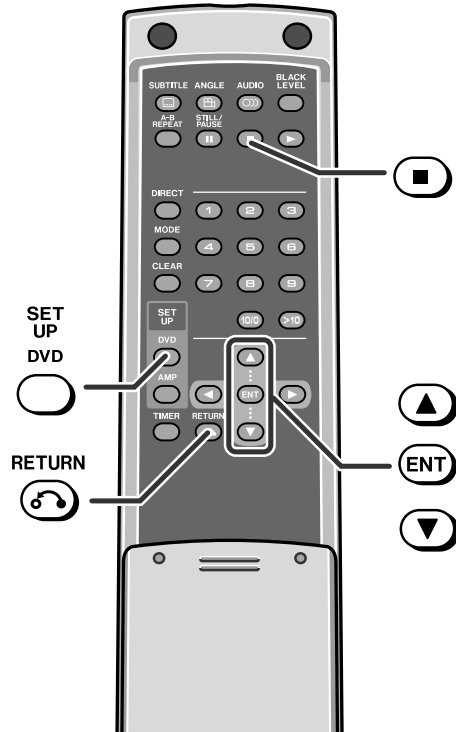

1 Press the ON/STAND-BY button to turn the power on.

- The startup screen appears.
- If the startup screen does not appear, set the input to "DVD".
- The disc should be stopped at this time.

2 After pressing the ■ button, press the SETUP DVD button.

3 Press the ▲ or ▼ button to select the menu and press the ENT button.

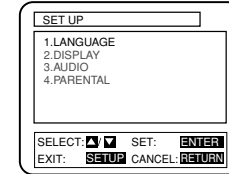

4 Press the ▲ or ▼ button to change the setting and press the ENT button.

Example: "PLAYER MENU" is selected

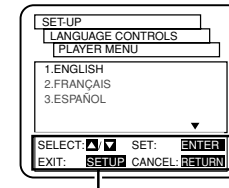

Repeat the operation as instructed.

(The number of repetition depends on the setting item.)

To change other settings, begin from step 3.

5 Press the SETUP DVD button.

The new setting is memorized.

Notes:

- You cannot display the setup screen while a disc is playing.
- See page 21 for selecting another language for disc menus.
- The previous screen appears by pressing the RETURN button while selecting an item or setting.

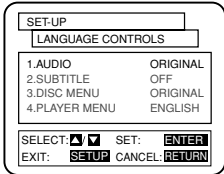
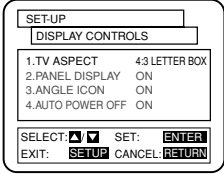
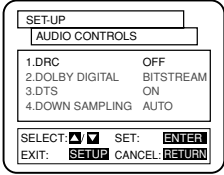
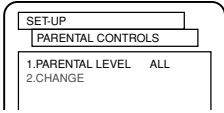
Setting	Selectable parameters (* indicates initial settings.)	Description	
LANGUAGE		AUDIO ORIGINAL * ENGLISH :	Selects the language audible from the speakers.
		SUBTITLE OFF * ENGLISH :	Selects the subtitle displayed on the TV screen.
		DISC MENU ORIGINAL ENGLISH * :	Selects the disc menu language.
		PLAYER MENU ENGLISH * FRANÇAIS :	Selects the initial or playback setting language.
DISPLAY		TV ASPECT 4:3 LETTER BOX 4:3 PAN & SCAN 16:9 WIDE	The screen mode should be set according to the connecting TV type. (For details, see page 22.)
		PANEL DISPLAY ON * OFF AUTO	Brightness settings for display. (When set to auto, the light turns off during playback.)
		ANGLE ICON ON * OFF	Sets or cancels angle icon (Pi) display on the TV screen.
		AUTO POWER OFF ON * OFF	The power automatically turns off when no operation is entered more than 35 minutes.
AUDIO (Digital output) ☆ Do not change the initial settings.		DRC OFF * ☆ ON	Sets or cancels the control over the volume range.
		DOLBY DIGITAL BITSTREAM* ☆ DPCM	Selects the type of a sound signal sent from the coaxial digital audio output jack.
		DTS ON * ☆ OFF	
		DOWN SAMPLING AUTO * ☆ 48 kHz 96 kHz	Converts the sound signal recorded by PCM of 96 kHz into 48 kHz.
PARENTAL		PARENTAL LEVEL ALL * 8 - 1	Sets the viewing restriction level of the DVD software.
		CHANGE Please enter a 4-digit password. "4737" cannot be set as a password. When you forget your password, cancel the current password by pressing "4737" using the direct number buttons (0 - 9).	

Changing the initial setting of DVD (continued)

■ Disc language

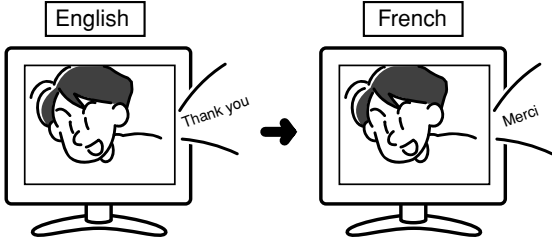
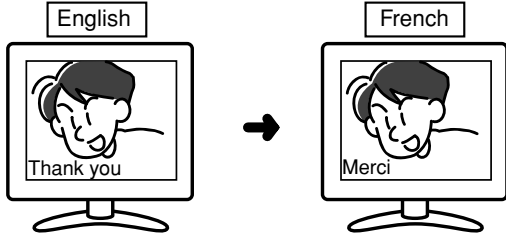
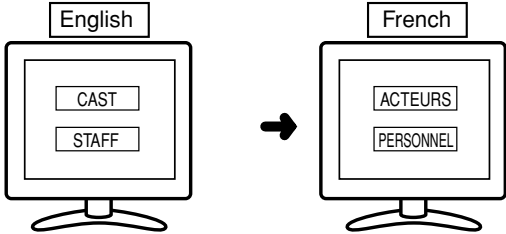
Indicator	Setting
AUDIO	<p>A language for audio can be set. You can specify a language for conversation and narration.</p> 
SUBTITLE	<p>A language for subtitle can be set. The subtitle is displayed in a specified language.</p> 
DISC MENU	<p>A language for disc menus can be set. Menu screens are displayed in a specified language.</p> 

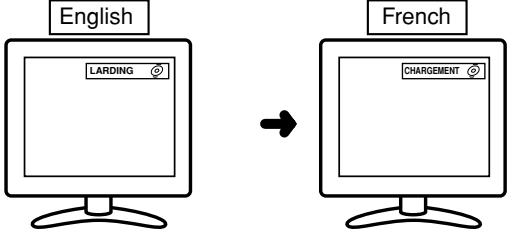
Indicator	Setting
PLAYER MENU	<p>A language for screen display can be set, such as initial settings or messages.</p> 

■ Other language settings

You can set the "OTHER" language for audio, subtitle, and disc menu. (Refer to "Language code list for disc language" on page 23.)



Example: to select 5464 (Croatian) as an audio language

- 1 Select "LANGUAGE" on the initial setting screen. (See steps 1 - 3 on page 19.)**
- 2 After selecting "AUDIO" in step 4 on page 19, select "OTHER" and press the ENT button.**
- 3 Enter "5464" using the direct number buttons.**
"5464 (HR)" will be displayed on the TV screen.
- 4 Press the SETUP DVD button.**

Note:

If the selected language is not recorded, the language set by the disc will be adopted.

■ Video format

Indicator	Setting
4:3 LETTER BOX	<p>When playing a wide image (16:9) disc, black bands are inserted at the top and bottom and you can enjoy full wide images (16:9) on a 4:3 size TV.</p>  <p>A 4:3 disc is played in 4:3.</p>
4:3 PAN & SCAN	<p>When playing a wide image (16:9) disc, the left and right sides of the image are cut (pan scan) to display a natural-looking 4:3 size image.</p> <p><u>A wide image disc without pan scan [PS] is played back in 4:3 letterbox.</u></p>  <p>A 4:3 disc is played in 4:3.</p>
16:9 WIDE	<p>A wide image (16:9) is displayed when playing a wide image (16:9) disc.</p>  <ul style="list-style-type: none"> ● When playing a 4:3 image disc, the image size depends on the setting of the connected TV. ● <u>If you play back a wide image (16:9) disc with the DVD player connected to a 4:3 TV, the vertically shrunk image is displayed.</u>

Note:

When playing the disc with a fixed video format, it will not change even if the TV screen size is changed.

■ Parental setting

Indicator	Setting
<u>Level 1</u>	<u>Only DVD software intended for children can be played back, with those intended for adult and general use prohibited.</u>
<u>Levels 2 to 7</u>	<u>Only DVD software intended for general use and children can be played back.</u>
<u>Level 8</u>	<u>DVD software of any grade (adult/general/children) can be played back.</u>
<u>All</u>	<u>Parental lock is cancelled.</u>

Notes:

- When entering a password for the first time, enter any 4-digit number. It will be set as your password automatically.
- While playing a disc with parental lock, the display may appear requesting a password in order to watch some restricted scenes. In such a case, enter the password to temporarily change the parental level.

Language code list for disc language

Code	Language name		Code	Language name	
4747	AA	Afar	5271	FY	Frisian
4748	AB	Abkhazian	5347	GA	Irish
4752	AF	Afrikaans	5350	GD	Scots Gaelic
4759	AM	Ameharic	5358	GL	Galician
4764	AR	Arabic	5360	GN	Guarani
4765	AS	Assamese	5367	GU	Gujarati
4771	AY	Aymara	5447	HA	Hausa
4772	AZ	Azerbaijani	5455	HI	Hindi
4847	BA	Bashkir	5464	HR	Croatian
4851	BE	Byelorussian	5467	HU	Hungarian
4853	BG	Bulgarian	5471	HY	Armenian
4854	BH	Bihari	5547	IA	Interlingua
4855	BI	Bislama	5551	IE	Interlingue
4860	BN	Bengali; Bangla	5557	IK	Inupiaq
4861	BO	Tibetan	5560	IN	Indonesian
4864	BR	Breton	5565	IS	Icelandic
4947	CA	Catalan	5566	IT	Italian
4961	CO	Corsican	5569	IW	Hebrew
4965	CS	Czech	5647	JA	Japanese
4971	CY	Welsh	5655	JI	Yiddish
5047	DA	Danish	5669	JW	Javanese
5051	DE	German	5747	KA	Georgian
5072	DZ	Bhutanese	5757	KK	Kazakh
5158	EL	Greek	5758	KL	Greenlandic
5160	EN	English	5759	KM	Cambodian
5161	EO	Esperanto	5760	KN	Kannada
5165	ES	Spanish	5761	KO	Korean
5166	ET	Estonian	5765	KS	Kashmiri
5167	EU	Basque	5767	KU	Kurdish
5247	FA	Persian	5771	KY	Kirghiz
5255	FI	Finnish	5847	LA	Latin
5256	FJ	Fiji	5860	LN	Lingala
5261	FO	Faroese	5861	LO	Laotian
5264	FR	French	5866	LT	Lithuanian
			5868	LV	Latvian, Lettish

Code	Language name		Code	Language name	
5953	MG	Malagasy	6560	SN	Shona
5955	MI	Maori	6561	SO	Somali
5957	MK	Macedonian	6563	SQ	Albanian
5958	ML	Malayalam	6564	SR	Serbian
5960	MN	Mongolian	6565	SS	Siswat
5961	MO	Moldavian	6566	ST	Sesotho
5964	MR	Marathi	6567	SU	Sundanese
5965	MS	Malay	6568	SV	Swedish
5966	MT	Maltese	6569	SW	Swahili
5971	MY	Burmese	6647	TA	Tamil
6047	NA	Nauruan	6651	TE	Telugu
6051	NE	Nepali	6653	TG	Tajik
6058	NL	Dutch	6654	TH	Thai
6061	NO	Norwegian	6655	TI	Tigrinya
6149	OC	Occitan	6657	TK	Turkmen
6159	OM	(Afan) Oromo	6658	TL	Tagalog
6164	OR	Oriya	6660	TN	Setswana
6247	PA	Panjabi	6661	TO	Tonga
6258	PL	Polish	6664	TR	Turkish
6265	PS	Pashto, Pushto	6665	TS	Tsonga
6266	PT	Portuguese	6666	TT	Tatar
6367	QU	Quechua	6669	TW	Twì
6459	RM	Rhaeto-Romance	6757	UK	Ukrainian
6460	RN	Kirundi	6764	UR	Urdu
6461	RO	Romanian	6772	UZ	Uzbek
6467	RU	Russian	6855	VI	Vietnamese
6469	RW	Kinyarwanda	6861	VO	Volapuk
6547	SA	Sanskrit	6961	WO	Wolof
6550	SD	Sindhi	7054	XH	Xhosa
6553	SG	Sango	7161	YO	Yoruba
6554	SH	Serbo-Croatian	7254	ZH	Chinese
6555	SI	Singhalese	7267	ZU	Zulu
6557	SK	Slovak			
6558	SL	Slovenian			
6559	SM	Samoan			

Setting the clock

By setting the AV control unit on time, you can use it not only as a clock but also for timer playback.

[Front]

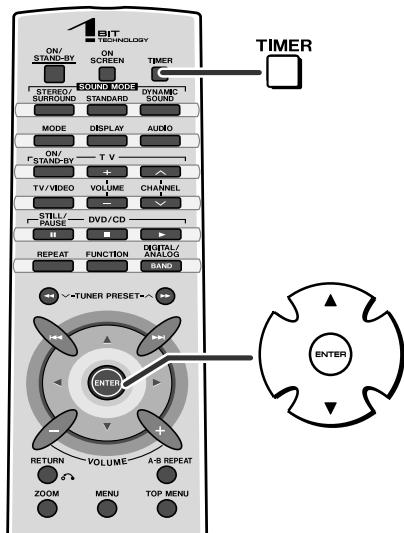

In this example, the clock is set for 9:30 AM.

1 Press the TIMER button.

A rectangular LCD display showing the word "ADJUST" in a simple, blocky font.

2 Within 5 seconds, press the ENTER button.

A rectangular LCD display showing "12:00 AM" in a digital clock format with dashes on either side.

3 Press the ▲ or ▼ button to adjust the hour and then press the ENTER button.

"AM 12:00" is 12 o'clock midnight.
"PM 12:00" is 12 o'clock noon.

A rectangular LCD display showing "9:00 AM" in a digital clock format with dashes on either side.

- Press the ▲ or ▼ button once to advance the time by 1 hour. Hold it down to advance continuously.
- The 12-hour display will appear.
- "AM" will change to "PM" automatically.

4 Press the ▲ or ▼ button to adjust the minutes and then press the ENTER button.

A rectangular LCD display showing "9:30 AM" in a digital clock format with dashes on either side.

- Press the ▲ or ▼ button once to advance the time by 1 minute. Hold it down to advance continuously.
- The hour will not advance even if minutes advance from "59" to "00".
- The clock starts from "0" second. (Seconds are not displayed.)
- The display returns to normal after approx. 2 seconds.

To confirm the time display:

Press the TIMER button on the remote control.
The time display will appear for about 5 seconds.

Caution:

Unplugging the DVD player and the subwoofer/amplifier unit or power failure will clear the clock setting.
Readjust the clock.

To readjust the clock:

Perform "Setting the clock" from the beginning.

- In step 1, the time will be displayed.
- Follow steps 2 - 4.

Note:

You can set the clock even when the power is off.

Listening to the radio

[Front]

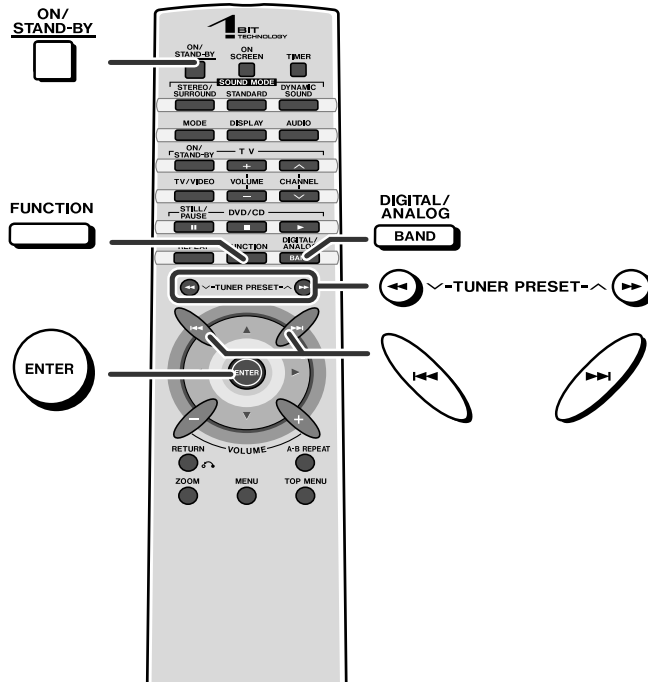

- 1 Press the ON/STAND-BY button to turn the power on.
- 2 Press the FUNCTION button to display FM or AM, and then the BAND button repeatedly to select the desired frequency band (FM STEREO, FM or AM).

- 3 Press the ◀◀ or ▶▶ button to tune in to the desired station.

Manual tuning:

Press the ◀◀ or ▶▶ button as many times as required to tune in to the desired station.

Auto tuning:

When the ◀◀ or ▶▶ button is pressed for more than 0.5 seconds, scanning will start automatically and the tuner will stop at the first receivable broadcast station.

Notes:

- When radio interference occurs, auto scan tuning may stop automatically at that point.
- Auto scan tuning will skip weak signal stations.
- To stop the auto tuning, press the ◀◀ or ▶▶ button again.

To receive an FM stereo transmission:

Press the BAND button to display the "STEREO" indicator.

- "ST" will appear when an FM broadcast is in stereo.

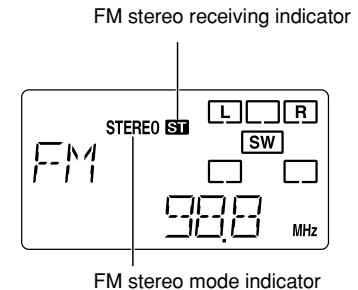

- If the FM reception is weak, press the BAND button to extinguish the "STEREO" indicator. The reception changes to monaural, and the sound becomes clearer.

After use:

Press the ON/STAND-BY button to enter the power stand-by mode.

Listening to the memorized station

■ Memorizing a station

You can store 40 AM and FM stations in memory and recall them at the push of a button. (Preset tuning)

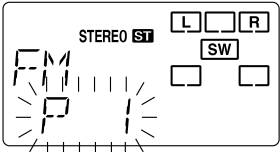
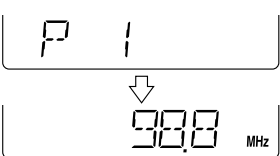
- 1 Perform steps 1 - 3 in "Listening to the radio" on page 25.
- 2 Press the ENTER button to enter the preset tuning saving mode.
- 3 Within 5 seconds, press the TUNER PRESET (✓ or ^) button to select the preset channel number.

Store the stations in memory, in order, starting with preset channel 1.
- 4 Within 5 seconds, press the ENTER button to store that station in memory.

- 5 Repeat steps 1 - 4 to set other stations, or to change a preset station.
When a new station is stored in memory, the station previously memorized will be erased.

Note:

The backup function protects the memorized stations for a few hours should there be a power failure or the AC power cord disconnection.

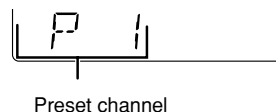
■ To recall a memorized station

Press the TUNER PRESET (✓ or ^) button to select the desired station.



It's easier with the direct buttons on the remote control.

For 1st to 10th stations --- Select the preset number between "1" and "10/0".
For 11th to 40th stations --- Press ">10" and select the preset number.
Example: 28th station --- ">10", "2", "8"
Press buttons within 5 seconds.

■ To erase all the contents of the preset memory

- 1 Hold the CLEAR button down for 3 seconds or more.
- 2 While "CLEAR" is displayed, press the ENT button.



[Back]

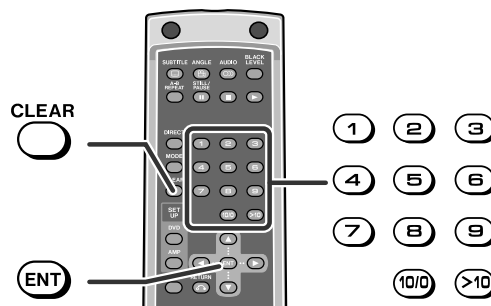

Playing a disc

Turn on the TV, and switch the input to the "VIDEO 1" or "VIDEO 2" etc. accordingly.

DVD CD MP3

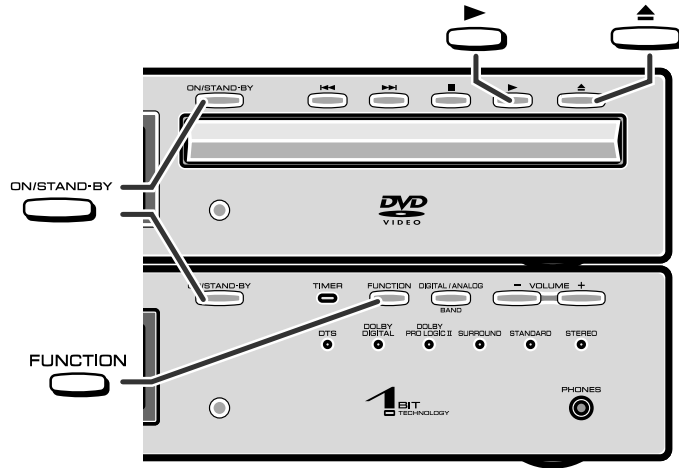

[Front]

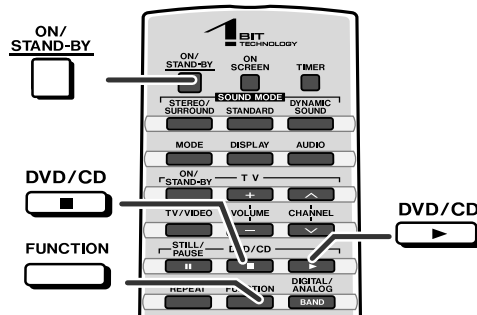

1 Press the ON/STAND-BY button to turn the power on.

The startup screen appears.



2 Press the FUNCTION button to set the input to "DVD".

- Select "DVD" when playing a audio CD.
- The same operation can be performed by pressing the DVD/CD ■ button on the remote control.

3 Press the ▲ button to open the disc tray.

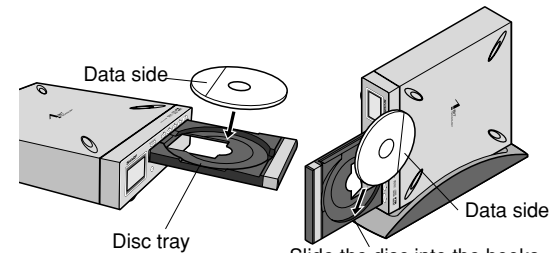

Slide the disc into the hooks.
(An 3" (8 cm) disc cannot be played.)

- Place the disc on the disc tray, label side up.
- If the display window of the DVD player is placed on the lower side, a disc may fall or may not be ejected.

4 Press the ▲ button to close the disc tray.

If the disc you are using supports auto start, it starts playing automatically (even if you do not press the ► button), as soon as you close the disc tray.

5 If you cannot start playback in step 4, press the ► button.

This can be operated by pressing the DVD/CD ► button on the remote control.

Note:

When the DVD player is turned on or the input source is switched to "DVD", no operation will be accepted for 5 seconds as the DVD player is proceeding the initial setting.

Playing a disc (continued)

Caution:

- Close the disc tray when it is not in use. Otherwise, dust may accumulate inside and cause malfunction to the DVD player.
- The DVD player is slightly heated when used for a long time. It does not mean the DVD player is damaged.
- When attempting to play discs with scratches or of a different region number, or unplayable or restricted (*1) discs, an error message will appear on the TV display and the disc will not play.

(*1) Some DVDs are restricted for viewing according to the audience age.

Notes:

- A safety feature automatically sets the system to the power stand-by mode if you set the volume level too high while playing certain types of discs. If this happens, lower the volume level and restart playback.
- Stop positions may be recorded on some discs. When you play such a disc, playback stops there.
- During an operation, "⊘" may appear indicating that the operation is disabled by the disc.
- When the DVD player is left unoperated for more than 5 minutes after pressing the stop button, a screen saver appears. Then, after additional 30 minutes, the power turns off.

[Front]

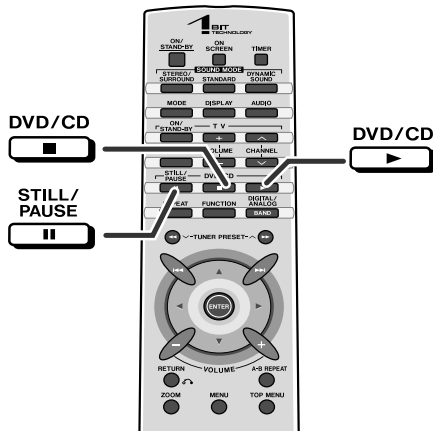

■ To interrupt playback

Press the STILL/PAUSE **||** button.

To resume playback from the same point, press the DVD/CD **▶** button.

■ To stop playback

Press the DVD/CD **■** button.

■ To resume playback after stopping (sequential playback) **DVD** **CD**

You can resume playback from the point that the playback is stopped.

1 While the disc is playing, press the DVD/CD **■** button.

The system stores the point you stopped.

2 To restart play, press the DVD/CD **▶** button.

Play resumes from the point you stopped.

To cancel the sequential playback:

Press the DVD/CD **■** button twice.

Notes:

- The sequential playback feature is disabled on some discs.
- Depending on the disc, playback may resume from slightly before the stopped position.

■ Headphones

- Before plugging in or unplugging the headphones, reduce the volume.
- Be sure your headphones have a 1/8" (3.5 mm) diameter plug and are between 16 ohms and 50 ohms impedance. The recommended impedance is 32 ohms.
- Plugging in the headphones disconnects the speakers automatically. Adjust the volume using the VOLUME buttons.
- You cannot use the surround feature with headphones.

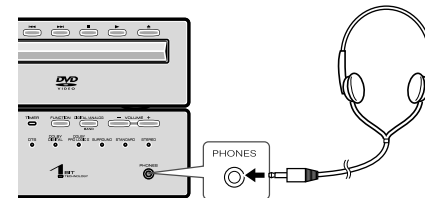

Basic operation

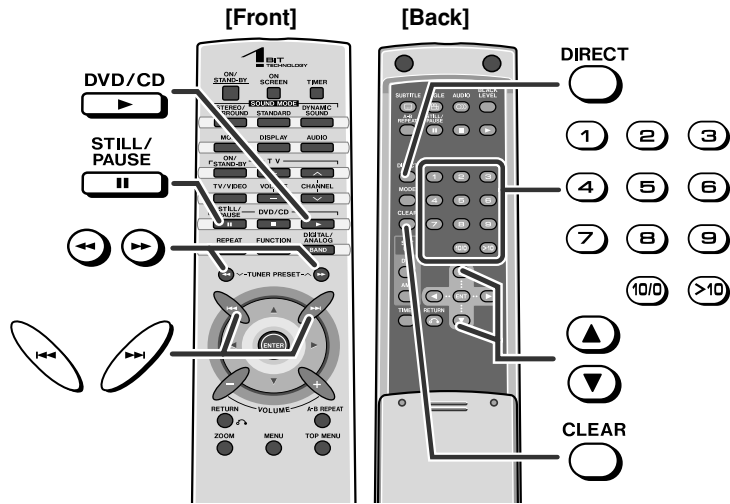

■ To locate the beginning of a chapter (track) (skip) DVD CD MP3

You can skip the current chapter (track) to the next.

While a disc is playing, press the ◀◀ or ▶▶ button.

- The ▶▶ button skips to the next chapter (track).
- The ◀◀ button skips to the beginning of the current chapter (track). Press the ◀◀ button again to skip to the beginning of the previous chapter (track).

Notes:

- The skip feature is disabled on some discs. Some discs do not display the chapter (track).
- On a DVD, search does not operate between titles.
- The same operation can be performed by pressing the ◀◀ or ▶▶ button on the DVD player.

■ Fast forward/Fast reverse (search) DVD CD

You can search the desired point as you play the disc.

1 While a disc is playing, press the ◀◀ or ▶▶ button.

Example: When the ▶▶ button is pressed

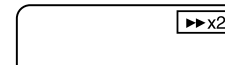

- The scanning speed will change as follows at each press of the button.

x 2 (about 2 times) → x 8 (about 8 times)

↑
x 60 (about 60 times) ← x 30 (about 30 times)

- The disc is forwarded by the ▶▶ button and reversed by the ◀◀ button.

2 Press the DVD/CD ▶ button to return to the normal playback.

Notes:

- On some discs, the search function is disabled.
- On a DVD, search does not operate between titles.
- While searching on a DVD the sound is not heard and the subtitles will not appear.
- For audio CDs, the scanning speed is fixed to 16 times. The sound will break up during search, but this is not faulty.
- When search is performed during the DVD playback, pictures may not be forwarded or reversed in the search speed specified in this manual, depending on the disc or the scene being played.
- The same operation can be performed by holding down the ◀◀ or ▶▶ button on the DVD player for 2 seconds or more.

■ To start playback from the desired point (direct play) DVD CD

To select and play the desired chapter (track) or title:

You can select and play the desired chapter (track) or title.

1 While in the stop or playback mode, press the DIRECT button.

Example: During DVD playback

Example: During CD playback

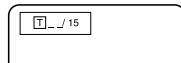
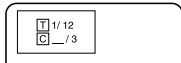

2 Selecting a chapter (track)

Enter the chapter (track) number using the direct buttons (0 - 9) within 30 seconds.

Selecting by title

Select "T" by pressing the ▲ or ▼ button within 30 seconds and enter the title number using the direct buttons (0 - 9).

The cursor automatically enters the chapter number.

Example: Chapter 1: "10/0", "1"
Chapter 12: "1", "2"

To play by specifying time:

You can play back from the desired point by specifying the time.

1 During playback, press the DIRECT button twice.



2 Within 30 seconds, specify the time with the direct buttons.



- To specify 1 hour 23 minutes and 40 seconds, enter "12340".
- If you enter the wrong number, press the CLEAR button and then reenter.

Notes:

- Direct play feature is disabled on some discs.
- Some discs may not display the chapter number.
- You can select the chapter (track) number by using the direct buttons only. If the track number is 2 digits or more, press ">10" and enter the number.
Example: Chapter 14: ">10", "1", "4"
- With DVDs, you can specify the desired point only in the current title and not in the other title.
- With audio CDs, you can specify the desired point only in the current track and not in the disc.
- Some discs cannot play from the specified point.
- Time search feature is disabled on some discs.
- You cannot specify the time while the disc is stopped.

■ Still picture/Frame advance DVD

You can freeze the image and advance frame by frame.

1 While a disc is playing, press the STILL/PAUSE button.

Each press of the STILL/PAUSE button advances the frame in the still mode.

2 Press the DVD/CD button to return to the normal playback.

Note:

Still and frame advance features are disabled on some discs.

■ Slow-motion play DVD

You can slow down the playback speed.

1 While a disc is playing, press the STILL/PAUSE button.

2 Press the button while the image is paused.

Three speeds are available. Each time the button is pressed, the speed of slow-motion playback changes in the following sequence:

× 1/16 (about 1/16 times) → × 1/8 (about 1/8 times) → × 1/2 (about 1/2 times)

The same operation can be performed by holding down the button on the DVD player for 2 seconds or more.

3 Press the DVD/CD button to return to the normal playback.

Note:

On some discs, the slow-motion playback functions are disabled.

Useful features

■ To play in random order (random play)

CD MP3

The system selects the order of playback.

- 1 While stopped, press the MODE button twice.

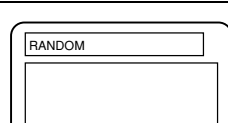

- 2 Press the DVD/CD ► button.

To cancel random play:

Press the DVD/CD ■ button.

Notes:

- You may not be able to use this function with some discs.
- When all of the tracks have been played in random playback mode, playback will stop automatically.
- You cannot set the random play while in the playback or pause mode.
- Random play is not allowed during programmed playback.
- To check the status during random playback, press the ON SCREEN button.

[Front]

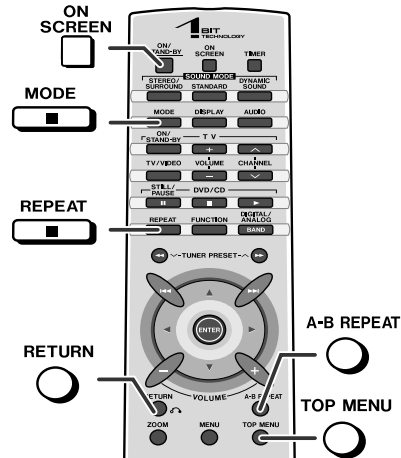

■ To play in the desired order (programmed playback) CD

You can play back the desired tracks in the sequence you want.
Maximum of 99 tracks can be programmed.

- 1 While stopped, press the MODE button.

The programming screen is displayed.

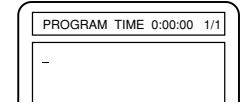

- 2 Enter a track number with direct buttons.

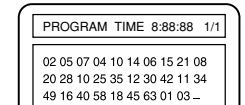

- Repeat the procedure above if you want to enter other title numbers. You can enter up to 99 titles in the sequence you want to play.
- If you enter the wrong number, press the CLEAR button and then reenter.
- When you enter a track number with 2 or more digits:
Example) track 14: ">10", "1", "4"

- 3 Press the ► button to start play.

- Programmed selections are memorized until a disc is removed.
- Playback is paused with the ■ button. When playback is resumed, programmed playback starts from the point you stopped.
- Pressing the ■ button twice turns off the programmed playback. If you start playback after pressing the MODE button, the programmed playback starts from the beginning.

To change the programmed contents:

Repeat the above procedures from step 1.

Notes:

- Programming cannot be performed while paused or in the playback mode.
- Sequence programming does not work with a disc that does not include title information.
- Sequence programming does not work with a disc that disables programming.
- To exit the programming procedure halfway through, press the RETURN ⏪ button.
- To check the status during the programmed playback, press the ON SCREEN or MODE button.
- Even if you press the ON/STAND-BY button to enter the stand-by mode or change the function from CD to another, the programmed selections will not be cleared.

■ To play repeatedly (repeat play) DVD CD MP3

You can play a chapter (track) or a title repeatedly by specifying it during playback.

1 While the disc is playing, press the REPEAT button.

Each time the button is pressed, repeat play mode changes in the following order.

DVD

OFF → CHAPTER → TITLE

Audio CD

OFF → TRACK → ALL

MP3

OFF → TRACK → ALBUM → DISC

2 Select "OFF" by pressing the REPEAT button repeatedly to return to the normal playback.

Caution:

After performing repeat play, be sure to press the DVD/CD ■ button. Otherwise, the disc will play continuously.

Notes:

- You may not be able to use this function with some discs.
- If you select "ALL" during the programmed/random play of an audio CD, the playback is repeated.
- If you press another button during the repeat play, the playback may be canceled.

■ To play the contents between the specified points repeatedly (A-B repeat) DVD CD

You can play the desired portion repeatedly by specifying it during playback.

1 While the disc is playing, press the A - B REPEAT button.



This registers the start point (A).

2 Press the A - B REPEAT button again.



This starts A-B repeat from the start point (A) to the end point (B).

3 Press the A - B REPEAT button to return to the normal playback.

Notes:

- A-B repeat play is disabled on some discs.
- A-B repeat play for DVD is possible only within a title.
- Perform A-B repeat play of an audio CD within a track.

■ To select a title from the top menu of the disc DVD

On a DVD with multiple titles, you can select a title from the top menu.

1 While in the stop or playback mode, press the TOP MENU button to display its title menu.

Example

1 Drama	2 Action
3 SF	4 Comedy

2 Use the ◀, ▶, ▲ or ▼ button to select the title, and then press the ENTER button.

- The selected title is played.
- Depending on the disc, a title can be selected by pressing the direct buttons (0 - 9) on the back of the remote control.

Notes:

- The procedure shown here provides only general steps. The actual procedure for using the title menu depends on the disc you are using. See the disc jacket for details.
- If the disc you are using does not have a title menu, nothing appears on the screen.

MP3 disc operation

[Front]

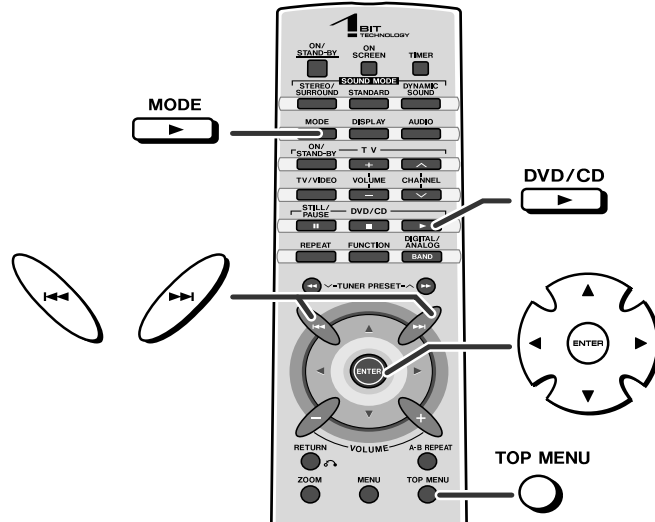

■ MP3 disc playback

You can play back CD-R/RW recorded in the MP3 format.

1 Load a disc containing MP3 tracks.

A menu screen appears.

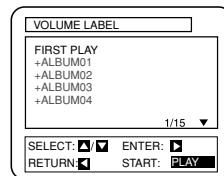

2 Press the ▲, ▼, ◀ or ▶ button to select a track and press the DVD/CD ► button.

Pressing the TOP MENU button goes back to the uppermost layer.

Direct play

- 1 Press the DIRECT button.
- 2 Press the ▲, ▼, ◀ or ▶ button to select a track and press the DVD/CD ► button.

Programmed play

- 1 While in the stop mode, press the MODE button.
- 2 Press the ▲ or ▼ button to select an album and press the ENTER button.
- 3 Press the ▲ or ▼ button to select a track and press the ENTER button. Press the ◀ button to return to the album selection screen.
- 4 After programming is completed, press the DVD/CD ► button.

Caution:

If you convert MP3 data to "audio CD" data when recording on a CD-R/RW, operate it as an audio CD. The MP3 operation is impossible.

Notes:

- "+" appears in front of the album name.
- Maximum of 14 characters can be displayed for an album name, and 25 characters for a track name. Underline, asterisk, and space may not be displayed.
- The system can recognize total of 255 albums and tracks.
- The 9th or later layers cannot be played back.
- You can select a track for direct playback using direct buttons when the screen display is turned off.
- The screen displays up to 5 tracks for the programmed play. If more tracks are entered, the next screen appears. Press the ◀◀ or ▶▶ button to switch the screen.
- If you enter a wrong track, press the CLEAR button.
- To stop the programmed play, press the DVD/CD ■ button twice.

Various settings

The subtitle language and the audio language you select are reset each time you turn off the system or change the disc. To always play back the DVD in the preferred languages, set them in the initial setting screen (see page 19).

[Back]

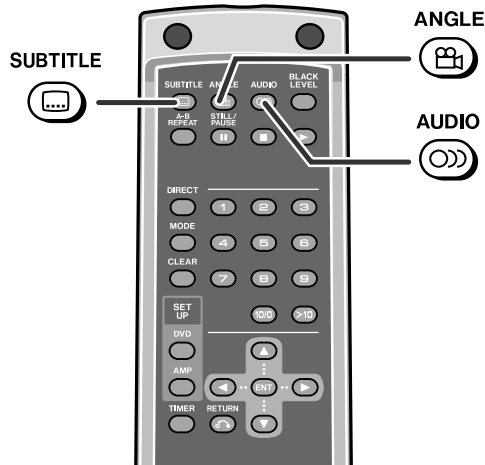

■ To change the subtitle language DVD

You can change the subtitle language or hide the subtitle during playback.

1 While a disc is playing, press the SUBTITLE button.	
2 Within 5 seconds, press the SUBTITLE button repeatedly to select the desired subtitle language. Press the SUBTITLE button and then the ◀ or ▶ button to hide the subtitle.	

Notes:

- Some DVDs prohibit changing the subtitle language.
- If no subtitles are recorded on the disc, "NOT AVAILABLE" is displayed.
- It may take a little time to switch the subtitle language to the selected one.
- The subtitle cannot be hidden on some DVDs.

■ To change the audio language (audio output) DVD CD

During playback, you can change the audio language (audio output).

1 While a disc is playing, press the AUDIO button.	
2 Within 5 seconds, press the AUDIO button repeatedly to select the desired audio number. DVD You can select one of audio languages that are recorded on a DVD. ENG → FRE → ... → SPA Audio CD STEREO → L-CH → R-CH	

Notes:

- The audio language on some DVDs may not be changed.
- For audio language and audio system, refer to the manual of the disc.

■ To change the angle DVD

You can change the angle of view when playing a DVD video disc that contains scenes recorded from multiple angles.

1 When "1" is displayed in the upper right corner of the TV screen, press the ANGLE button.
2 Within 5 seconds, press the ANGLE button repeatedly to select the desired angle number.

Notes:

- Some DVDs prohibit changing the angle.
- The angle number is not displayed if the disc on which angle not recorded is entered.
- Refer to the manual of the disc as the operation may vary depending on the disc.

Various settings (continued)

■ To brighten an image (black level setting) DVD

The image can be adjusted during playback.

- 1 While a disc is playing, press the **BLACK LEVEL** button.

BLACK LEVEL: ON

- 2 Within 5 seconds, press the **BLACK LEVEL** button repeatedly to select "ON" or "OFF".

	Setting
OFF	Normal image
ON	Bright image

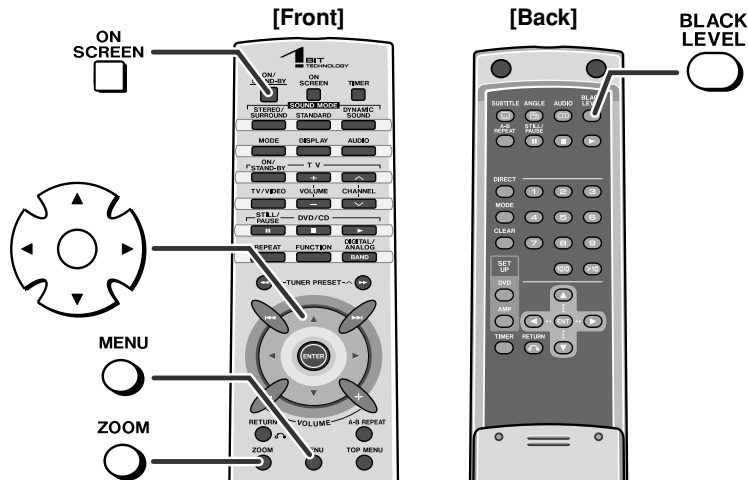

■ To zoom in on an image (zoom) DVD

You can magnify images during DVD playback.

- 1 While a disc is playing, press the **ZOOM** button.

ZOOM [x2]

ZOOM indicator

Each press of the ZOOM button cycles through the zoom settings as follows:

ZOOM [x 2] → ZOOM [x 4] → ZOOM [OFF]

- 2 To shift the view and display the desired part of a zoomed image, press the **▲**, **▼**, **◀** or **▶** button repeatedly.

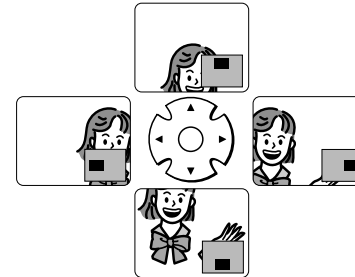

Notes:

- An image may become distorted when zoomed.
- Subtitles cannot be zoomed.
- For the part currently viewed, refer to the indication in the lower right section of the screen.

■ To change the display on TV screen DVD

CD MP3

You can display or hide the operation indicators on the TV screen.

While the disc is playing, press the ON SCREEN button. (The display is changed at each press of this button.)

DVD

Audio CD

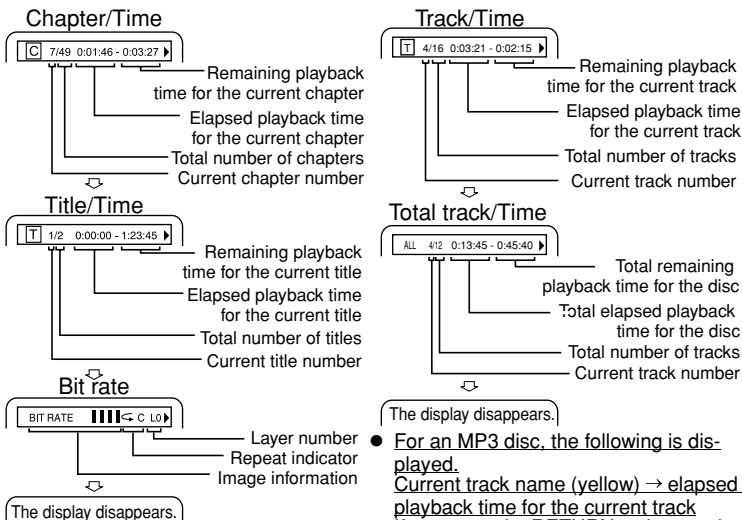

- For an MP3 disc, the following is displayed.
Current track name (yellow) → elapsed playback time for the current track
- If you press the RETURN button, the display disappears.

■ To select a subtitle or audio language from the disc menu DVD

You can select the desired subtitle or audio language and sound system (Dolby Digital (5.1ch) or DTS sound) on your DVD if it has a disc menu.

- While the disc is stopped or played, press the MENU button to display the disc menu.

Example

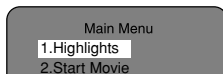

- Press the ▲, ▼, ◀ or ▶ button to change the setting and press the ENTER button.

You can also use direct buttons for some discs.

Note:

The procedure shown here provides only general steps. The actual procedure for using the disc menu depends on the disc you are using. See the disc jacket for details.

■ DVD mode operation indicators



The following are examples of display indicators that appear during DVD playback.

Operation	TV screen	DVD player display
When the power is on without a disc		
Disc data is being read		
Type of disc		
Stop		
Play		
Pause		
Slow		
Fast Forward		
Fast Reverse		

Enjoy the surround sound (sound mode)

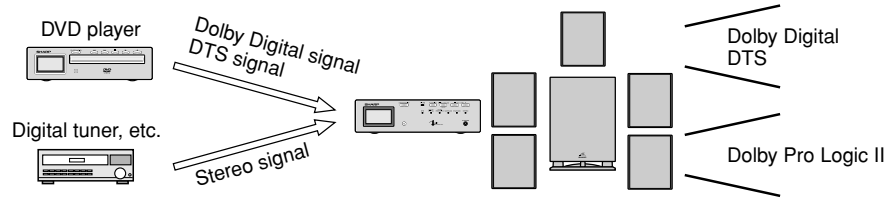
The spatial sound effect is activated when you play a DVD recorded in Dolby Digital or DTS. You can also enjoy 2-channel stereo sound in Dolby Pro Logic II.



Types of surround	Source	Contents	Switchable sound mode
Dolby Digital	 Disc with this trademark	One of the digital audio systems for theatrical use. You can enjoy the stereophonic effect in the home theater system. <u>The disc recorded in the Dolby Digital system is recognized by the system automatically when it is played back.</u>	Stereo
			Standard Dynamic sound
DTS (Digital Theater Systems)	 Disc with this trademark	<u>One of the digital audio systems for theatrical use. As the sound quality is emphasized, you can enjoy the realistic sound effect in the home theater system. The disc recorded in the DTS system is recognized by the system automatically when it is played back.</u>	Stereo
			Standard Dynamic sound
Dolby Pro Logic II	Stereo-recorded discs and video tapes	When playing a stereo-recorded disc or video tape, it is recognized by the Dolby Pro Logic II function and the sound is changed to the 5.1ch digital surround sound automatically. More natural sound effect can be achieved.	Stereo (*)
			Surround (*)
			Standard Dynamic sound

If (*) is selected, the "PRO LOGIC II" indicator goes out.
(To select the sound mode, see page 39.)

Acoustic effect**Standard**

The maximum of 5.1ch surround sound is reproduced to provide three-dimensional effect. The system automatically emits the 5.1ch sound according to the recorded audio signal.

"STANDARD" will appear.

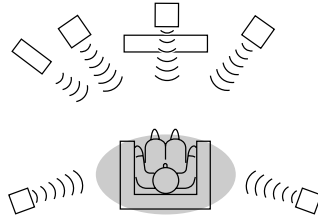
**Dynamic sound**

You can enjoy the normal surround with various scenes.

MOVIE: The bass level is increased for powerful sound effect.

MUSIC: You can enjoy lively sound by producing the articulate sound.

NIGHT: Soft but powerful sound is achieved even at low volumes.

Surround

This mode provides expansive listening area by emitting 2-channel sound.

"SURROUND" will appear.

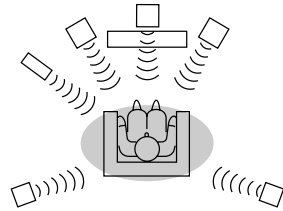
**Stereo**

You can enjoy the great acoustic effects of the front speakers and subwoofer.

"STEREO" will appear.

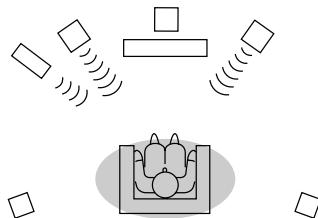

The input signal is recognized automatically and the indicator lights up.

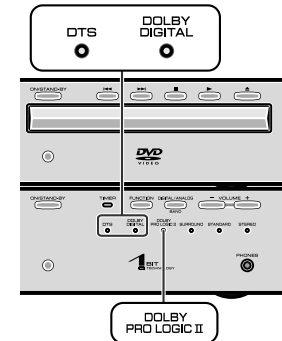

- This indicator is lit when the 2ch signals are entered to extend them to the 5.1ch surround sound.
- Even the 2ch sound recorded with Dolby Digital will be extended to the 5.1ch.

Notes:

- You can switch the audio while playing the disc of multiple types (Dolby Digital, DTS, etc.) (page 34).
- When the surround mode is set to the standard or surround mode, the sound of monaural signals is heard only from the center speaker.
- When the surround mode is set to stereo, the same monaural sound is reproduced in the both of the right and left channels.
- The surround indicator is lit according to the input audio source.

- 1 Front Left Signal Indicator
- 2 Center Signal Indicator
- 3 Front Right Signal Indicator
- 4 LFE indicator
- 5 Surround Left Signal Indicator
- 6 Surround Monaural Signal Indicator
- 7 Surround Right Signal Indicator

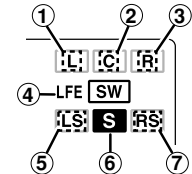

Enjoy the surround sound (sound mode) (continued)

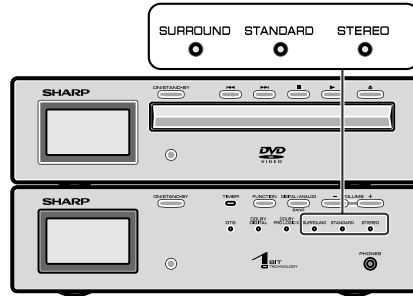

[Front]

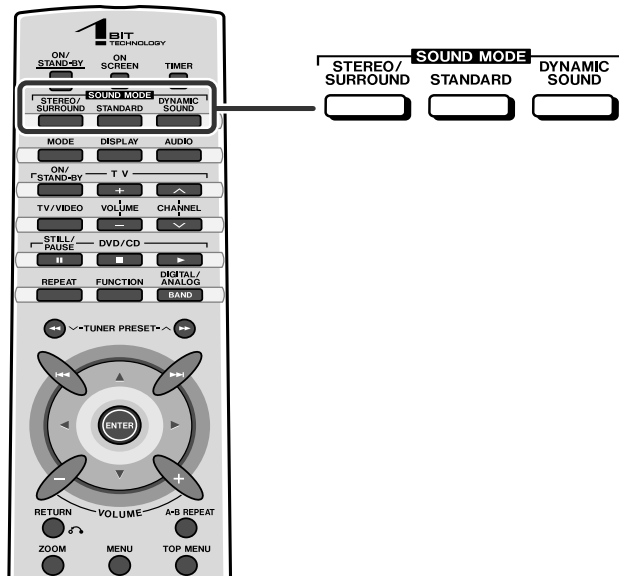

■ Changing the sound mode DVD CD

To enjoy in standard mode:

While the disc is playing, press the STANDARD button.

"STANDARD" will appear.

Example: Dolby Digital 5.1ch

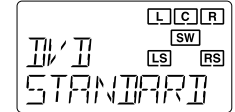

To enjoy with dynamic sound:

Press the DYNAMIC SOUND button.

Each press of this button changes the mode in the order of "MOVIE" → "MUSIC" → "NIGHT".

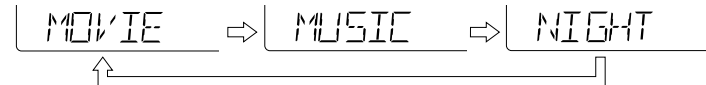

Press the STANDARD button to restore the normal surround sound.

To enjoy in surround or stereo mode:

While the disc is playing, press the STEREO/SURROUND button.

"SURROUND" or "STEREO" will appear.

Each time you press the button, the display switches between "SURROUND" and "STEREO".

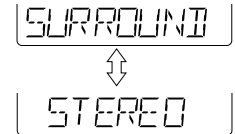

Notes:

- The sound mode is changed to "STANDARD" by pressing the DYNAMIC SOUND button while in the stereo or surround mode.
- When the "Dolby Digital" or "DTS" indicator is lit, you cannot select the surround mode.
- Some discs are recorded at 96kHz of sampling frequency. When this type of disc is played, the sound mode is changed to "STEREO" automatically. The sound mode cannot be changed during its playback.

Changing the registration in the remote control

Sharp's TVs can be operated with the remote control of this system without registering the operation (except for some models). (See page 47.) You can also operate TVs of other manufacturers by changing the registration in the remote control.

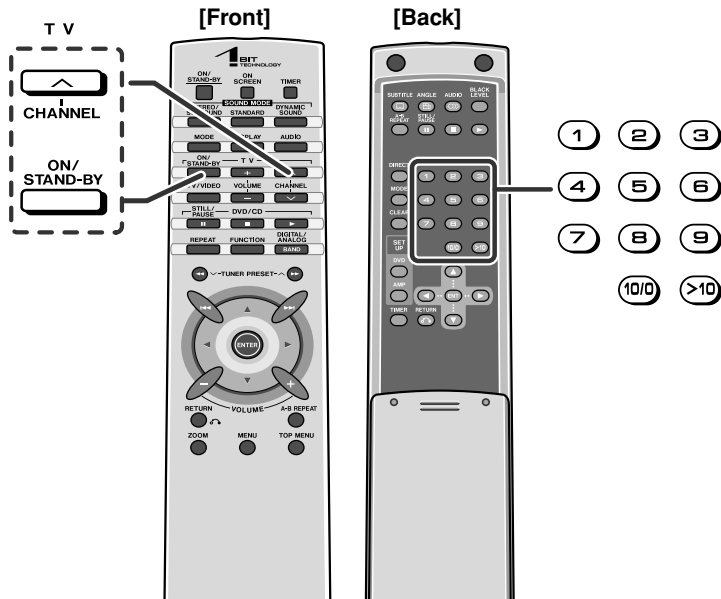

■ Changing the TV registration

Use buttons on both sides of the remote control.

1 While holding down the TV ON/STAND-BY button, press the TV CHANNEL \wedge button.

2 Enter the manufacturer setting number (2 digits) with the direct buttons (0 - 9) and press the TV ON/STAND-BY button.

The setting is registered and the TV can be operated with the remote control of this system.

TV manufacturer	Setting number	TV manufacturer	Setting number
SHARP	01(*), 02	EMERSON	37, 38, 39, 40
PANASONIC	03, 04, 05	FISHER	23
JVC	06, 07, 08	GE	41, 42
SONY	09	GOLDSTAR	43
MITSUBISHI	10, 11, 12, 13	MAGNAVOX	44, 45
HITACHI	14, 15, 16, 17	RCA	46, 47, 48, 49
TOSHIBA	18, 19	ZENITH	50, 51
PIONEER	20	PHILIPS	52, 53
SANYO	21, 22, 23, 24	THOMSON	54
FUJITSU	25	GRUNDIG	55
AIWA	26	FERGUSON	56, 57
FUNAI	27, 28, 29, 30, 31, 32	ITT NOKIA	58, 59
SAMSUNG	33, 34, 35, 36	LOEWE	60, 61

(*): The default manufacturer number is 01 (SHARP).

Notes:

- As for manufacturers with 2 or more setting numbers, select one of those numbers with which you can operate the TV.
- The number will not be set unless the registration is completed within 30 seconds. In that case, try registration again.
- Once you set a number, the number previously memorized will be canceled.
- After replacing the batteries in the remote control, the registered number may automatically be set to 01 (SHARP). If it occurs, register the desired number again.
- Registration cannot be executed depending on TVs. Even if numbers can be set, some buttons may not work.

Speaker settings

The speaker settings are not displayed on the TV screen.

[Back]

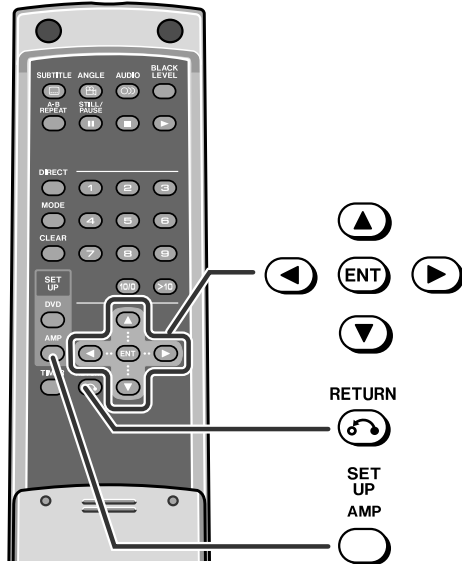

Speaker size setting

You can change the sizes of the speakers if they are not supplied ones.

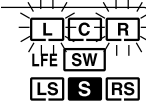
- 1 Press the **SETUP AMP** button, and the **◀** or **▶** button to select "SP SIZE". Then press the **ENT** button.
- 2 Within 10 seconds, press the **◀** or **▶** button to select the desired speaker. The indicators of selected speakers flash.
 
- 3 Within 10 seconds, press the **▲** or **▼** button to select their sizes. To set sizes of other speakers, repeat the operation from step 2.

Caution:

To set the speaker size, set the sound mode to "STANDARD".

Note:

The recommended size is set for the supplied speakers. See the upper table on page 42 for other speakers.

Speaker delay setting

When some of the speakers are at a different distance from the listening point, you can select the speaker delay to make it seem as though the speaker distances are the same.

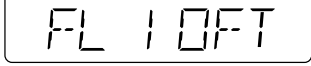
- 1 Press the **SETUP AMP** button, and the **◀** or **▶** button to select "SP DELAY". Then press the **ENT** button.
- 2 Within 30 seconds, press the **◀** or **▶** button to select the desired speaker.
- 3 Within 30 seconds, press the **▲** or **▼** button to select the distance and press the **ENT** button.
 
 - You can change the distance in 1 feet (0.3 m) steps.
 - To set the distance of other speakers, repeat the operation from step 2.

Measure the distance between each speaker and the listening position, and set the speaker delay.

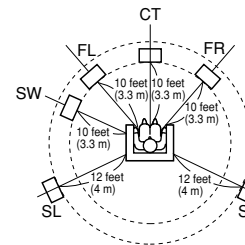

In the left illustration, the front speakers, center speaker, and subwoofer are positioned at 10 feet (3.3 m), and the surround speakers are at 12 feet (4 m) from the listening position.

Note:

See the lower table on page 42 for the adjustable range.

■ Speaker level setting

If sounds from the speakers are uneven, you can equalize them by adjusting the speaker levels.

1 Press the **SETUP AMP** button, and the **◀** or **▶** button to select "SP LEVEL". Then press the **ENT** button.

2 Within 10 seconds, press the **◀** or **▶** button to select the desired speaker.

3 Within 10 seconds, press the **▲** or **▼** button to adjust the level.

The image shows a rectangular LCD display with the text 'FL + 5 dB' inside. 'FL' is on the left, '+ 5' is in the middle, and 'dB' is on the right.

- You can adjust the level at 1 dB intervals.
- To adjust the levels of other speakers, repeat the operation from step 2.

Notes:

- Adjust the level of the subwoofer if the sound from it is distorted.
- See the lower table for the adjustable range.

■ Test tone

You can check the sound output from the speakers. (If the speaker levels are not equalized, they can be adjusted, too.)

Press the **SETUP AMP** button, and the **◀** or **▶** button to select "TONE". Then press the **ENT** button.

The test tone will be heard from each speaker, in order, at about 2-second intervals.

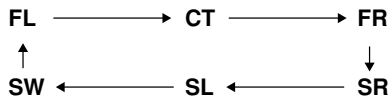

If the levels are not equal:

While the test tone sounds, press the **▲** or **▼** to adjust the level. You can select a speaker by pressing the **◀** or **▶** button.

Note:

If NO (OFF) is selected for a speaker in the speaker size setting, no test tone will be heard from it.

■ To end the speaker setting

Press the **RETURN** button twice.

Speaker type	Speaker size	
Front speaker (Left, Right)	F-LARGE	Large diameter
	F-SMALL *	Small diameter
Center speaker	C-LARGE	Large diameter
	C-SMALL *	Small diameter
	C-NO	OFF
Surround speaker (Left, Right)	S-LARGE	Large diameter
	S-SMALL *	Small diameter
	S-NO	OFF

(*) indicates the default setting.

Speaker type		Delay range	Level range
FL	Front speaker (Left)	1 - 29 ft	- 6 dB - + 6 dB
CT	Center speaker	1 - 29 ft	- 6 dB - + 6 dB
FR	Front speaker (Right)	1 - 29 ft	- 6 dB - + 6 dB
SL	Surround speaker (Left)	1 - 29 ft	- 6 dB - + 6 dB
SR	Surround speaker (Right)	1 - 29 ft	- 6 dB - + 6 dB
SW	Subwoofer	1 - 29 ft	- 10 dB - + 10 dB

Default settings:

Delay --- 6 feet (2 m)

Level --- 0 dB

Timer and sleep operation

The system turns on and plays the desired source (DVD, CD, MP3 disc, tuner) at the preset time.

[Front]

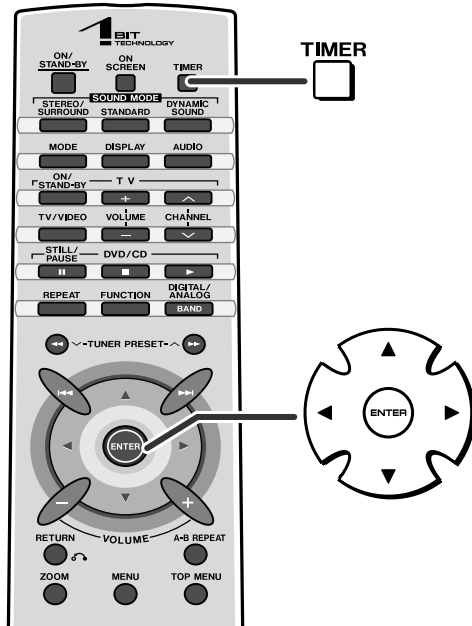

■ Setting the timer

Before setting timer:

- 1 Set the AV control unit on time (page 24).
If it is not on time, you cannot use the timer function.
- 2 Prepare for playback and set the TV to the desired channel.



- 1 Turn the power on and press the **TIMER** button.

Set the AV control unit on time if "TIMER STANDBY" does not appear.

- 2 Within 10 seconds, press the **◀** or **▶** button to select "TIMER SET", and press the **ENTER** button.

- 3 Press the **▲** or **▼** button to adjust the hour and then press the **ENTER** button.

- 4 Press the **▲** or **▼** button to adjust the minutes and then press the **ENTER** button.

The start time is set and the finish time (1 hour later) will be displayed automatically.

- 5 Set the time to finish as in steps 3 and 4 above.

- 6 Switch input with the **▲** or **▼** button, and then press the **ENTER** button.

When you select the tuner, select a station by pressing the **▲** or **▼** button, and then press the **ENTER** button.

DVD DIGITAL ↔ DVD ANALOG	↕	
TUNER	↕	AUX DIGITAL
VCR ↔ TV ↔ AUX ANALOG	↕	

- 7 Adjust the volume with the **▲** or **▼** button and press the **ENTER** button.

Settings are displayed in order and the AV control unit will enter the timer standby mode.

The timer setting indicator on the AV control unit will appear.

To check the timer setting:

- 1 While in the timer playback stand-by mode, press the TIMER button.

- 2 Within 10 seconds, press the ◀ or ▶ button to select "TIMER CALL", and press the ENTER button.

The system returns to the timer playback stand-by mode after the setting contents are displayed in order.

When the start time is reached:

Playback starts automatically and the volume increases gradually.

The timer playback indicator flashes.

Timer play indicator

Timer set Indicator

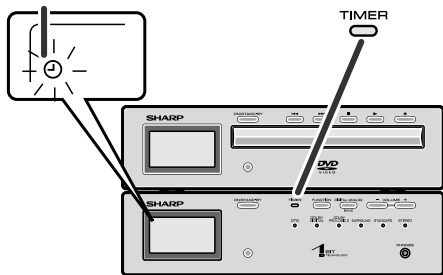
**When the finish time is reached:**

The system is set to the power stand-by mode automatically.

Reusing the memorized timer setting:

The timer setting will be memorized once it is entered. To reuse the same setting, perform the following operations.

- 1 Turn the power on and press the TIMER button.
Set the AV control unit on time if "TIMER STANDBY" does not appear.
- 2 Within 10 seconds, press the ENTER button.
After the setting contents are displayed in order, the system is set to the timer playback stand-by mode.

Changing the timer setting:

Turn the power on, and repeat the operation from step 1 in "Setting the timer" (page 43).

Canceling the timer playback:

Timer playback is canceled by turning the power on while in the timer playback stand-by mode. The same operation can be performed in the following procedure without turning the power on.

- 1 Press the TIMER button.
"TIMER CANCEL" will appear.
- 2 Within 10 seconds, press the ENTER button.
Timer playback will be canceled (the contents of the setting will not be canceled).

Caution:

- The contents of the setting will be erased if the system is unplugged or a power failure occurs. In such cases, set the timer again.
- This system cannot set the timer of other equipment.
- When setting the timer playback using the digital tuner, TV, VCR, or the connected equipment should be set to timer playback at the same time.



Note:

The timer operation is disabled with discs containing menus.

Timer and sleep operation (continued)

■ Setting the sleep timer

You can set the system to the power stand-by mode at the specified time.

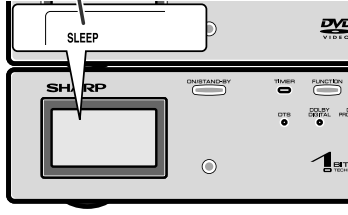
<p>1 While the disc is playing, press the TIMER button.</p>	
<p>2 Within 10 seconds, press the ◀ or ▶ button to select "SLEEP SET", and press the ENTER button.</p>	
<p>3 Press the ▲ or ▼ button to select set the time. (Maximum: 2 hours - Minimum: 1 minute)</p> <ul style="list-style-type: none"> • 2 hours - 5 minutes → 5-minute intervals • 5 minutes - 1 minute → 1-minute intervals 	
<p>4 Press the ENTER button.</p> <p>The sleep timer indicator lights up and playback begins.</p>	
	
<p>5 Your system will enter the power stand-by mode automatically after the preset time has elapsed.</p> <p>The volume will be turned down 1 minute before the sleep operation finishes. You cannot change the volume.</p>	

Caution:

This system cannot set the sleep timer of other equipment.

When setting the sleep timer using the digital tuner, TV, or VCR, the connected equipment should be set to sleep timer at the same time.

To confirm the remaining sleep time:

- 1 While "SLEEP" is indicated, press the **TIMER** button.
- 2 Within 10 seconds, press the **◀** or **▶** button to select "SLEEP".

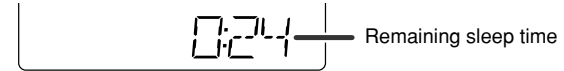

- The remaining sleep time is displayed for about 10 seconds.
- You can change the remaining sleep time while it is displayed by pressing the **ENTER** button (steps 3 - 4).

To cancel the sleep operation:

Sleep operation is canceled by turning the power on while "SLEEP" is indicated. The same operation can be performed in the following procedure without turning the power on.

- 1 Press the **TIMER** button.
- 2 Within 10 seconds, press the **◀** or **▶** button to select "SLEEP OFF", and press the **ENTER** button.

■ To use timer and sleep operation together

You can fall asleep and wake up to the same CD.

<p>1 Set the sleep timer (steps 1 - 4). Sleep operation starts.</p>
<p>2 Set the timer playback. (Setting the timer on page 43, steps 1 - 7)</p>

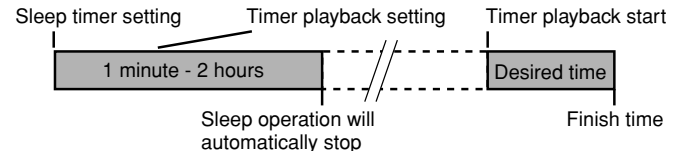

Audio connection of other equipment

You can hear the sound of other equipment via this product. Connect VCR or digital tuner to TV directly to receive the images (refer to the operation manual of each equipment).

■ Connection for the VCR sound

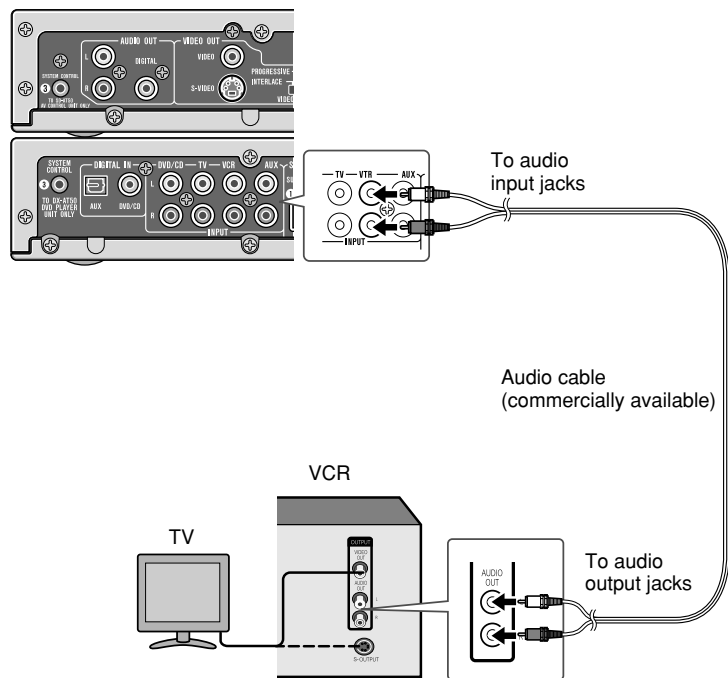

Caution:

Turn off the other equipment before making this connection.

Note:

Insert the plugs fully to avoid fuzzy pictures or noise.

■ Connection for the digital tuner sound (or other optical digital equipment such as an MD player)

The S-video cable offers you clearer images. You can hear the sound by connecting one of the audio cable or optical digital cable. If you are using the digital tuner with the optical output jack, you can enjoy better sound by connecting the tuner to the optical digital input jack of the AV control unit.

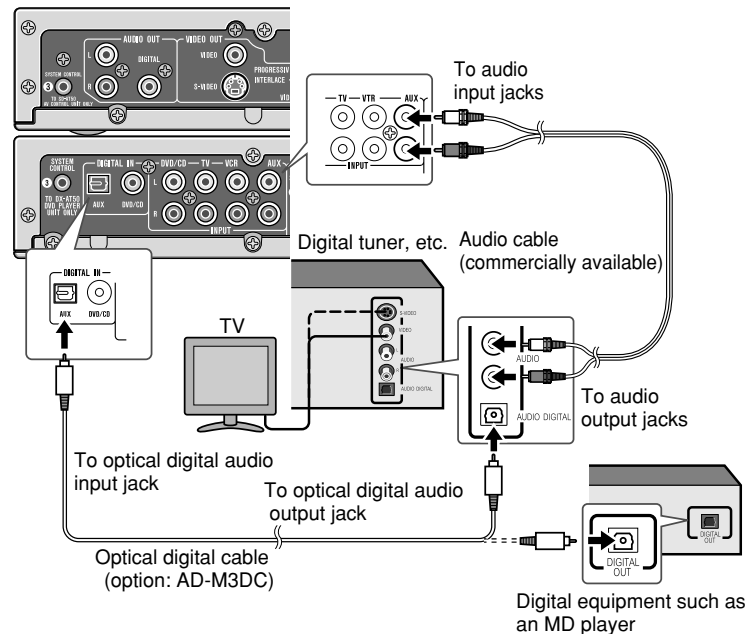

Caution:

Turn off the other equipment before making this connection.

Notes:

- Change the audio between analog and digital with the DIGITAL/ANALOG button. (page 47)
- Insert the plugs fully to avoid fuzzy pictures or noise.
- When connecting with an optical digital cable, set the digital output of the digital tuner to PCM. Refer to the operation manual of the digital tuner.

Operating the connected TV

The connected TV can be operated with the remote control of this system. The factory setting allows you to operate Sharp's TVs and VCRs with it. To operate those of other manufacturers, change the contents registered in the remote control. (See page 40.)

[Front]

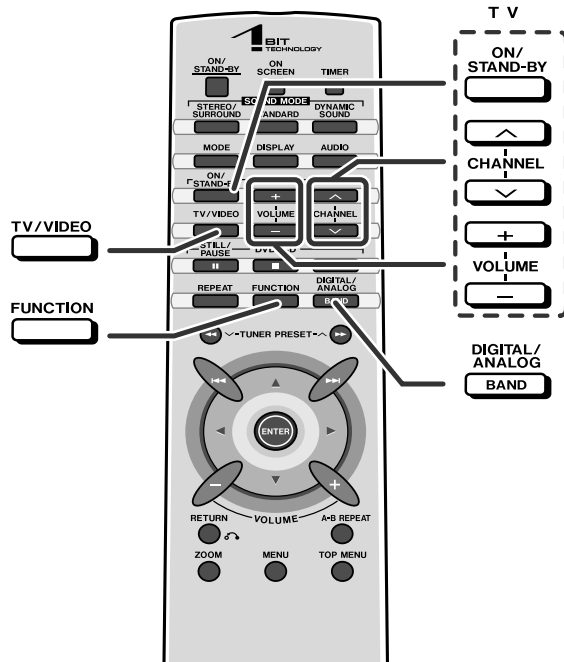

■ Watching TV

- 1 Press the TV ON/STAND-BY button to turn on the TV.
- 2 Press the TV CHANNEL (^ or v) button to set the channel.
- 3 Press the TV VOLUME (^ or v) button to control the TV volume.

To enjoy the sound from the speakers of this system:
Turn on the system and press the FUNCTION button to select "TV".

■ Watching digital tuner, etc.



- 1 Turn on the system and press the FUNCTION button.
 - For the digital tuner, select "AUX".
 - For the video, select "VCR".
- 2 Turn on the digital tuner, etc.
- 3 Press the TV/VIDEO button, and set the TV to VIDEO 1, VIDEO 2, etc.
 - When you watch a digital television, press the DIGITAL/ANALOG button and select "AUX ANALOG" or "AUX DIGITAL" depending on the connected input terminal.
 - When you see a video, press the playback button of the VCR.

Caution:

Some Sharp TVs and VCRs cannot be operated with this remote control.

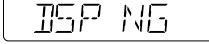
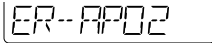

Error indicators and warnings

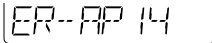
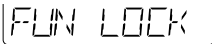
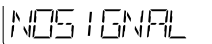
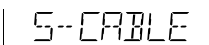
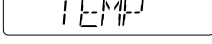
When you load an unplayable disc or fail to perform operations properly, the following messages are displayed on the AV control unit, the DVD player and the TV screen.

AV control unit display	Meaning
	<ul style="list-style-type: none"> Place the system away from noise source or plug the AC power cords to other AC outlets. (*)
	<ul style="list-style-type: none"> The speaker is not connected properly. The amplifier is defective. <p>Set the system to the stand-by mode and turn the power on again. (*)</p>
	<ul style="list-style-type: none"> The amplifier is defective. <p>Set the system to the stand-by mode and turn the power on again. (*)</p>
	<ul style="list-style-type: none"> The subwoofer/amplifier is defective. Place the system away from noise source or plug the AC power cords to other AC outlets. (*)
	<ul style="list-style-type: none"> The cooling fan on the back of the subwoofer/amplifier does not run due to foreign objects caught in it. Is the system unplugged?
	<ul style="list-style-type: none"> The digital audio input jack is not connected properly. Unspecified signal is received and cannot be recognized.
	<ul style="list-style-type: none"> The system connection cable is unplugged.
	<ul style="list-style-type: none"> The temperature is too high. <p>Set the system to the stand-by mode and wait for a while.</p>

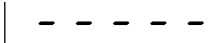
(*): Should the same message appear even if the DVD player and the subwoofer/amplifier unit are unplugged and plugged in or are set to the stand-by mode and on again, contact your local dealer where you purchased the subwoofer/amplifier unit.

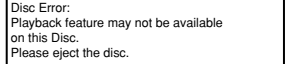
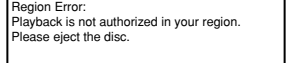
DVD player display	Meaning
	<ul style="list-style-type: none"> The disc is not loaded. The disc is scratched or dirty and cannot be recognized. The disc is loaded upside down.

TV screen	Meaning
	The disc cannot be played with this system or the disc is loaded in an incorrect way.
	The region number of the DVD is not "1" or "ALL".
	The disc does not support the operation described in this operation manual.

■ Condensation

Sudden temperature changes, storage or operation in an extremely humid environment may cause condensation inside the cabinet (laser pickup, etc.) or on the transmitter on the remote control.

Condensation can cause the system to malfunction. If this happens, leave the power on with no disc in the DVD player until normal playback is possible (about 1 hour). Wipe off any condensation on the transmitter with a soft cloth before operating the system.

Troubleshooting chart

Many potential problems can be resolved by the owner without calling a service technician.

If something is wrong with this product, check the following before calling your authorized SHARP dealer or service center.

■ General

Symptom	Possible cause	Reference page
No sound is heard.	<ul style="list-style-type: none"> ● Is the volume level set to "0"? ● Are the headphones connected? ● Are the speaker wires disconnected? ● Is the speaker size set to NO (OFF)? 	P. 18 P. 28 P. 12 P. 41
The sounds from speakers are not well balanced.	<ul style="list-style-type: none"> ● Are the speaker cords connected to the wrong channels? ● Is each speaker placed at the same distance from the listener? ● Are speakers adjusted to the same level? 	P. 12 P. 16 P. 42
Noise is heard during playback.	● <u>Move the system away from any computers or mobile phones.</u>	—
<u>When a button is pressed, the system does not respond.</u>	● <u>Set the system to the power standby mode and then turn it back on. If the system still malfunctions, reset it.</u>	P. 50
Interference or noise occurs on the TV image.	● <u>Is the system placed near TV with internal antenna? Use an outdoor antenna.</u>	P. 13
Timer playback does not start.	● Did you remove the plug from the wall jack, or did a power failure occur?	P. 24
The display on the system is dark.	● Hold down the DISPLAY button on the remote control for 2 seconds or more to select "ON".	P. 18
The power is not turned on.	<ul style="list-style-type: none"> ● <u>Is the system unplugged?</u> ● <u>Is the system connection cord (for DVD player) disconnected?</u> ● <u>The protection circuit may be activated. Unplug and plug in the power cord again after 5 minutes or more.</u> 	P. 18 P. 11 P. 50

Symptom	Possible cause	Reference page
The sound is not reproduced in the Dolby Digital 5.1 ch.	● <u>Is the initial setup screen set to "DPCM"? Change it to "BIT-STREAM".</u>	P. 20
No images are displayed.	<ul style="list-style-type: none"> ● Is TV turned on? ● Is the input of TV switched? 	P. 47 P. 47

■ Tuner

Symptom	Possible cause	Reference page
<u>Radio makes unusual noise consecutively.</u>	<ul style="list-style-type: none"> ● Is the system placed near the TV or computer? ● <u>Is the FM antenna or AM loop antenna placed properly? Move the antenna away from the AC power cord or the system if located near.</u> 	P. 13 P. 13

■ Remote control

Symptom	Possible cause	Reference page
The remote control does not operate properly.	<ul style="list-style-type: none"> ● Is the battery polarity respected? ● Are the batteries dead? ● Is the distance or angle incorrect? ● <u>Are there any obstructions in front of the AV control unit?</u> ● Is the remote control sensor exposed to strong light (inverter fluorescent light, direct sunlight, etc.)? ● Is the remote control for another equipment used simultaneously? ● Are buttons on the front and back faces of the remote control pressed simultaneously? 	P. 17 — P. 17 — P. 17 — —
<u>The system cannot be turned on with the remote control.</u>	<ul style="list-style-type: none"> ● <u>Are the AC power cords of the DVD player and the subwoofer/amplifier unit plugged in?</u> ● Are the batteries inserted? 	P. 18 P. 17

■ DVD Player

Symptom	Possible cause	Reference page
Even though a disc has been loaded, "-----" is displayed.	<ul style="list-style-type: none"> ● Is the disc loaded upside down? ● Is the disc very dirty? 	—
Playback sounds are skipped.	<ul style="list-style-type: none"> ● Does the disc satisfy the standards? ● <u>Is the system located near excessive vibrations?</u> ● <u>Has condensation formed inside the system?</u> 	P. 48
The control buttons do not function. Music or video playback is interrupted.	<ul style="list-style-type: none"> ● Is the disc very dirty? ● Does the disc satisfy the standards? ● <u>Is the system located near excessive vibrations?</u> ● <u>Has condensation formed inside the system?</u> 	P. 48
Pictures and sound are skipped.	<ul style="list-style-type: none"> ● Is the disc very dirty? ● <u>Is the system located near excessive vibrations?</u> ● <u>Has condensation formed inside the system?</u> 	P. 48
The system does not operate even if the power is on.	<ul style="list-style-type: none"> ● <u>Is a disc other than DVD (region number 1 or ALL), audio CD loaded?</u> 	P. 5
Image cannot be played back. (Sound is not heard.)	<ul style="list-style-type: none"> ● Are the video and audio cables connected improperly? ● <u>Is a disc other than DVD (region number 1 or ALL), audio CD loaded?</u> ● Is the disc very dirty? ● Is the disc loaded upside down? ● Clean the optical pickup if it is dirty. ● Is the TV input set to "VIDEO 1/VIDEO 2" etc.? ● <u>Is the system turned on?</u> 	P. 11 - 15 P. 5 — — P. 51 P. 47 P. 18

■ If trouble occurs

When this product is subjected to strong external interference (mechanical shock, excessive static electricity, abnormal supply voltage due to lightning, etc.) or if it is operated incorrectly, it may malfunction.

If such a problem occurs, do the following:

Resetting the AV control unit:

- 1 Unplug the subwoofer/amplifier unit.
- 2 While holding down the ON/STAND-BY button, plug in the AC power cord. At this time, the component will not be turned on.
- 3 Press the ON/STAND-BY button again to turn the power on.

Caution:

This operation will erase all data stored in memory and restore various settings to the initial status (default).

Resetting the DVD player:

Unplug the unit and, after waiting 5 minutes or longer, plug it in again.

When the protection circuit is activated:

When short-circuiting the speaker cords or turning the volume too high, the protection circuit may be activated and the power may turn off.
Unplug the subwoofer/amplifier unit and plug it in again after 5 minutes or more.
Turn down the volume if set too high.

■ Before transporting the system

- 1 Press the ON/STAND-BY button of the DVD player to turn the power on.
- 2 Open the disc tray and remove the disc.
- 3 Close the disc tray and enter the system to stand-by mode.
- 4 After the power indicator goes off, unplug the system.

Maintenance

■ Cleaning the cabinet

Periodically wipe the cabinet with a soft cloth and a diluted soap solution, then with a dry cloth.



- Do not use chemicals for cleaning (gasoline, paint thinner, etc.). It may damage the cabinet finish.
- Do not apply oil to the inside of the each component. It may cause malfunctions.

■ Cleaning the DVD pickup lens

In order to ensure proper operation of the DVD player, preventative maintenance (cleaning of the laser pickup lens) should be performed periodically. Lens cleaners are commercially available. Contact your local DVD software dealer for options.

Optional accessories

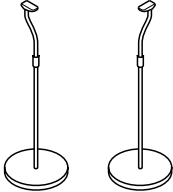
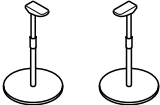
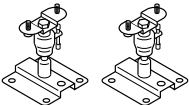
Use only the specified optional accessories to operate this product properly. For speaker installation, read instructions supplied with stands or brackets.

FLOOR SPEAKER STAND	TABLE SPEAKER STAND
Model: AD-AT10ST 	Model: AD-AT10LS 
SPEAKER WALL BRACKET	OPTICAL DIGITAL CABLE
Model: AD-AT10SA 	Model: AD-M1DC 

The appearance of optional accessories may differ from the illustrations above.

Specifications

As part of our policy of continuous improvement, SHARP reserves the right to make design and specification changes for product improvement without prior notice. The performance specification figures indicated are nominal values of production units. There may be some deviations from these values in individual units.

■ DVD Player

Power source	AC 120 V, 60 Hz
Power consumption	17 W
Dimensions	Width: 8-1/2" (215 mm) Height: 2-5/16" (58 mm) Depth: 10-1/8" (257 mm)
Weight	4.4 lbs. (2.0 kg)
Video signal	Horizontal resolution: 500 lines S/N ratio: 60 dB
Signal system	NTSC color
Frequency response	DVD (linear sound): 20 Hz to 22 kHz (sampling rate: 48 kHz) 20 Hz to 44 kHz (sampling rate: 96 kHz) CD: 20 Hz to 20 kHz
S/N ratio	CD: 110 dB
Dynamic range	DVD (linear sound): 95 dB CD: 94 dB
Total harmonic distortion ratio	0.007 % maximum
Wow and flutter	Unmeasurable (less than 0.001% W. peak)
Audio output terminals	Digital output (coaxial) × 1 Analogue output (RCA type) × 2 (L/R)
Video output terminals	Video output (RCA type) × 1 S-video output (S-terminal) × 1 Component video output (RCA type) × 3
Other terminal	System control × 1

■ AV Control Unit

Dimensions	Width: 8-1/2" (215 mm) Height: 2-5/16" (58 mm) Depth: 10-5/16" (261 mm)
Weight	2.9 lbs. (1.3 kg)
Audio input terminals	Digital input (Optical) × 1 Digital input (coaxial) × 1 Analogue input (RCA type) × 8 (L/R)
Audio output terminal	Headphones: 16 - 50 ohms (recommended: 32 ohms)
Other terminals	System control × 3
Frequency range	FM: 87.5 - 108 MHz AM: 530 - 1,720 kHz

■ Subwoofer/Amplifier Unit

Power source	AC 120 V, 60 Hz	
Power consumption	80 W	
Dimensions	Width: 10-1/4" (260 mm) Height: 14-11/16" (373 mm) Depth: 16-5/8" (421 mm)	
Weight	21.8 lbs. (9.9 kg)	
Power output (FTC)	40 watts minimum RMS per channel into 4 ohms from 20 Hz to 20 kHz, 1 % total harmonic distortion	
Rated power output	Front: 50 W + 50 W, Center: 50 W, Surround: 50 W + 50 W (4 ohms at 1 kHz) Subwoofer: 50 W (4 ohms at 100 Hz)	
Amplification system	64fs 1-bit switching (Remarks: fs = 44.1 kHz)	
A/D noise shaping	7th-order $\Delta \Sigma$ (delta - sigma) modulation	
Terminals	Front speakers, Center speaker, Surround speakers: 4 ohms System control × 2	
Subwoofer	Type	4-3/4" (12 cm) woofer (Magnetic shield)
	Maximum input power	100 W
	Rated input power	50 W
	Impedance	4 ohms

■ Front/Center/Surround speakers

Type	Full range speaker system (Magnetic shield) 3-1/8" (8 cm) speaker
Maximum input power	100 W
Rated input power	50 W
Impedance	4 ohms
Dimensions	Width: 3-3/4" (95 mm) Height: 4-1/2" (114 mm) Depth: 4-1/8" (104 mm)
Weight	1.5 lbs. (0.7 kg)/each

VALID IN U.S.A. ONLY

CONSUMER LIMITED WARRANTY

SHARP ELECTRONICS CORPORATION warrants to the first consumer purchaser that this Sharp brand product (the "Product"), when shipped in its original container, will be free from defective workmanship and materials, and agrees that it will, at its option, either repair the defect or replace the defective Product or part thereof with a new or remanufactured equivalent at no charge to the purchaser for parts or labor for the period(s) set forth below.

This warranty does not apply to any appearance items of the Product nor to the additional excluded item(s) set forth below nor to any Product the exterior of which has been damaged or defaced, which has been subjected to improper voltage or other misuse, abnormal service or handling, or which has been altered or modified in design or construction.

In order to enforce the rights under this limited warranty, the purchaser should follow the steps set forth below and provide proof of purchase to the servicer.

The limited warranty described herein is in addition to whatever implied warranties may be granted to purchasers by law. ALL IMPLIED WARRANTIES INCLUDING THE WARRANTIES OF MERCHANTABILITY AND FITNESS FOR USE ARE LIMITED TO THE PERIOD(S) FROM THE DATE OF PURCHASE SET FORTH BELOW. Some states do not allow limitations on how long an implied warranty lasts, so the above limitation may not apply to you.

Neither the sales personnel of the seller nor any other person is authorized to make any warranties other than those described herein, or to extend the duration of any warranties beyond the time period described herein on behalf of Sharp.

The warranties described herein shall be the sole and exclusive warranties granted by Sharp and shall be the sole and exclusive remedy available to the purchaser. Correction of defects, in the manner and for the period of time described herein, shall constitute complete fulfillment of all liabilities and responsibilities of Sharp to the purchaser with respect to the Product, and shall constitute full satisfaction of all claims, whether based on contract, negligence, strict liability or otherwise. In no event shall Sharp be liable, or in any way responsible, for any damages or defects in the Product which were caused by repairs or attempted repairs performed by anyone other than an authorized servicer. Nor shall Sharp be liable or in any way responsible for any incidental or consequential economic or property damage. Some states do not allow the exclusion of incidental or consequential damages, so the above exclusion may not apply to you.

THIS WARRANTY GIVES YOU SPECIFIC LEGAL RIGHTS. YOU MAY ALSO HAVE OTHER RIGHTS WHICH VARY FROM STATE TO STATE.

Model Specific Section

Your Product Model Number & Description:

**SD-AT50 1 Bit Digital Home Theater
DX-AT50 DVD Player**

(Be sure to have this information available when you need service for your Product.)

Warranty Period for this Product:

One (1) year parts and labor from the date of purchase.

Additional Item(s) Excluded from Warranty Coverage (if any):

Non-functional accessories, supplies, and consumable items.

Where to Obtain Service:

At a Sharp Authorized Servicer located in the United States.

To find a location of the nearest Sharp Authorized Servicer, call Sharp toll free at 1-800-BE-SHARP.

What to do to Obtain Service:

Ship prepaid or carry in your Product to a Sharp Authorized Servicer.

Be sure to have **Proof of Purchase** available. If you ship the Product, be sure it is insured and packaged securely.

TO OBTAIN SUPPLY, ACCESSORY OR PRODUCT INFORMATION, CALL **1-800-BE-SHARP**.

SHARP

SHARP ELECTRONICS CORPORATION

Sharp Plaza, Mahwah, New Jersey 07430-2135

SHARP CORPORATION

PRINTED IN MALAYSIA
IMPRIMÉ EN MALAISIE
TINSK0142AWZZ
02G R HK ①