

# SHARP

## MD COMPACT COMPONENT SYSTEM

### OPERATION MANUAL

MODEL  
**MD-MX20**

Thank you for purchasing this SHARP product.  
To obtain the best performance from this product, please read  
this manual carefully. It will guide you in operating your SHARP  
product.

MD-MX20 MD Compact Component System consisting of  
MD-MX20 (main unit) and CP-MX20 (speaker system).

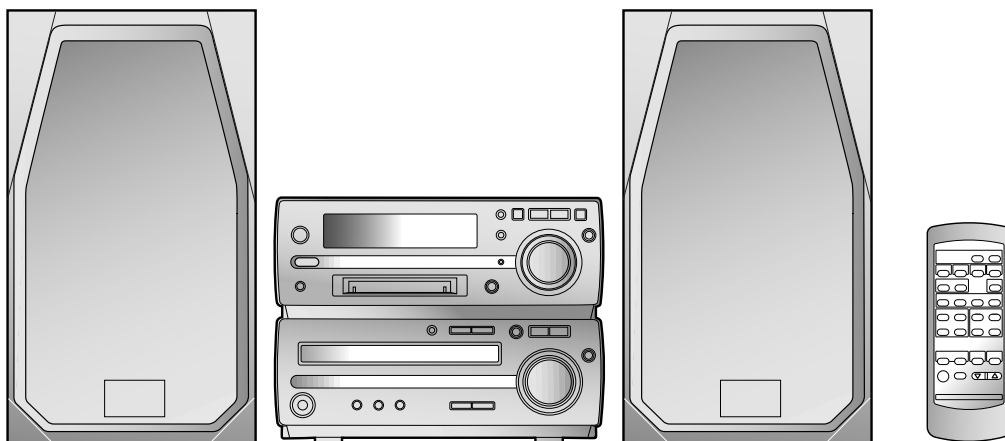

## SPECIAL NOTES



The lightning flash with arrowhead symbol, within an equilateral triangle, is intended to alert the user to the presence of uninsulated “dangerous voltage” within the product’s enclosure that may be of sufficient magnitude to constitute a risk of electric shock to persons.

### CAUTION

RISK OF ELECTRIC SHOCK  
DO NOT OPEN

**CAUTION: TO REDUCE THE RISK OF ELECTRIC SHOCK, DO NOT REMOVE COVER (OR BACK). NO USER-SERVICEABLE PARTS INSIDE. REFER SERVICING TO QUALIFIED SERVICE PERSONNEL.**



The exclamation point within an equilateral triangle is intended to alert the user to the presence of important operating and maintenance (servicing) instructions in the literature accompanying the appliance.

**Caution - use of controls or adjustments or performance of procedures other than those specified herein may result in hazardous radiation exposure.**

**WARNING: TO REDUCE THE RISK OF FIRE OR ELECTRIC SHOCK, DO NOT EXPOSE THIS APPLIANCE TO RAIN OR MOISTURE.**

### Note:

This equipment has been tested and found to comply with the limits for a Class B digital device, pursuant to Part 15 of the FCC Rules.

These limits are designed to provide reasonable protection against harmful interference in a residential installation.

This equipment generates, uses, and can radiate radio frequency energy and, if not installed and used in accordance with the instructions, may cause harmful interference to radio communications.

However, there is no guarantee that interference will not occur in a particular installation. If this equipment does cause harmful interference to radio or television reception, which can be determined by turning the equipment off and on, the user is encouraged to try to correct the interference by one or more of the following measures:

- Reorient or relocate the receiving antenna.
- Increase the separation between the equipment and receiver.
- Connect the equipment into an outlet on a circuit different from that to which the receiver is connected.
- Consult the dealer or an experienced radio/TV technician for help.

### WARNING

FCC Regulations state that any unauthorized changes or modifications to this equipment not expressly approved by the manufacturer could void the user’s authority to operate this equipment.

- It is the intent of Sharp that this product be used in full compliance with the copyright laws of the United States and that prior permission be obtained from copyright owners whenever necessary.
- US and foreign patents licensed from Dolby Laboratories Licensing Corporation.

### FOR YOUR RECORDS

For your assistance in reporting this unit in case of loss or theft, please record below the model number and serial number which are located on the rear of the unit.

**Please retain this information.**

Model number \_\_\_\_\_

Serial number \_\_\_\_\_

Date of purchase \_\_\_\_\_

Place of purchase \_\_\_\_\_

## IMPORTANT SAFEGUARDS

### CAUTION

All the safety and operating instructions should be read before the appliance is operated, and should be retained for future reference.

Electrical energy can perform many useful functions. This unit has been engineered and manufactured to assure your personal safety. Improper use can result in potential electrical shock or fire hazards. In order not to defeat the safeguards, observe the following basic rules for its installation, use and servicing.

- 1 Heed Warnings - All warnings on the appliance and in the operating instructions should be adhered to.
- 2 Follow Instructions - All operating and use instructions should be followed.
- 3 Water and Moisture - The appliance should not be used near water - for example, near a bathtub, washbowl, kitchen sink, laundry tub, in a wet basement, or near a swimming pool, etc.
- 4 Carts and Stands - The appliance should be used only with a cart or stand that is recommended by the manufacturer.

- An appliance and cart combination should be moved with care. Quick stops, excessive force, and uneven surfaces may cause the appliance and cart combination to overturn.



- 5 Wall or Ceiling Mounting - The appliance should be mounted to a wall or ceiling only as recommended by the manufacturer.
- 6 Ventilation - The appliance should be situated so that its location or position does not interfere with its proper ventilation. For example, the appliance should not be situated on a bed, sofa, rug, or similar surface that may block the ventilation openings; or, placed in a built-in installation, such as a bookcase or cabinet that may impede the flow of air through the ventilation openings.
- 7 Heat - The appliance should be situated away from heat sources such as radiators, heat registers, stoves, or other appliances (including amplifiers) that produce heat.
- 8 Power Sources - The appliance should be connected to a power supply only of the type described in the operating instructions or as marked on the appliance.
- 9 Power-Cord Protection - Power-supply cords should be routed so that they are not likely to be walked on or pinched by items placed upon or against them, paying particular attention to cords at plugs, convenience receptacles, and the point where they exit from the appliance.
- 10 Do not use liquid cleaners or aerosol cleaners. Use a damp cloth for cleaning.
- 11 Power Lines - An outdoor antenna should be located away from power lines.

- 12 Outdoor Antenna Grounding - If an outside antenna is connected to the receiver, be sure the antenna system is grounded so as to provide some protection against voltage surges and built-up static charges. Section 810 of the National Electrical Code, ANSI/NFPA No. 70-1984, provides information with respect to proper grounding of the mast and supporting structure, grounding of the lead-in wire to an antenna discharge unit, size of grounding conductors, location of antenna-discharge unit, connection to grounding electrodes, and requirements for the grounding electrode.

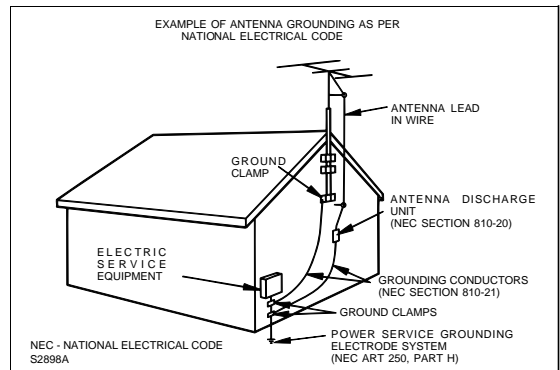

- 13 Nonuse Periods - The power cord of the appliance should be unplugged from the outlet when left unused for a long period of time.
- 14 Object and Liquid Entry - Care should be taken so that objects do not fall and liquids are not spilled into the enclosure through openings.
- 15 Damage Requiring Service - The appliance should be serviced by qualified service personnel when:
  - A The power-supply cord or the plug has been damaged; or
  - B Objects have fallen, or liquid has been spilled into the appliance; or
  - C The appliance has been exposed to rain; or
  - D The appliance does not appear to operate normally or exhibits a marked change in performance; or
  - E The appliance has been dropped, or the enclosure damaged.
- 16 Servicing - The user should not attempt to service the appliance beyond that described in the operating instructions. All other servicing should be referred to qualified service personnel.
- 17 Grounding or Polarization - Precautions should be taken so that the grounding or polarization means of an appliance is not defeated.

# CONTENTS

	Page		Page
ACCESSORIES .....	3	MINIDISC EDITING .....	26-31
PRECAUTIONS .....	4	TIMER OPERATION .....	32-33
NAMES OF CONTROLS AND INDICATORS .....	5-7	USING EXTERNAL UNITS .....	34-35
PREPARATION FOR USE .....	8-10	WHAT IS A MINIDISC? .....	36
SETTING THE CLOCK .....	11	MINIDISC SYSTEM LIMITATIONS .....	37
SOUND CONTROL .....	12	TROUBLESHOOTING .....	37-38
COMPACT DISC OPERATION .....	13	RESETTING THE MICROCOMPUTER .....	38
MINIDISC OPERATION .....	14	ERROR MESSAGES .....	39
CONVENIENT CD AND MINIDISC OPERATIONS .....	15-18	MAINTENANCE .....	40
RADIO OPERATION .....	19-20	SPECIFICATIONS .....	40
MINIDISC RECORDING .....	21-25	CONSUMER LIMITED WARRANTY .....	Back cover

## ACCESSORIES

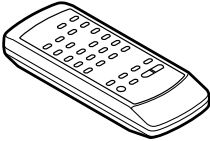
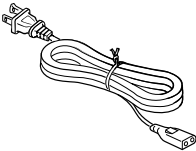
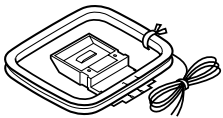
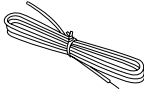
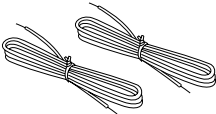
 <p><b>Remote control × 1</b> (RRMCG0208AWSA)</p>	 <p><b>AC power cord × 1</b> (QACCD0025AWZZ)</p>	 <p><b>AM loop antenna × 1</b> (QANTL0009AWZZ)</p>
 <p><b>FM antenna × 1</b> (92LFANT1746A)</p>	 <p><b>Speaker wire × 2</b> (92L291-0089)</p>	

**Note:**

Parts and accessories mentioned in this operation manual other than those in the drawing are not included.

## PRECAUTIONS

### ■ General

- Please ensure that the equipment is positioned in a well ventilated area and ensure that there is at least 4" (10cm) of free space along the sides and back. There must also be a minimum of 4" (10cm) of free space on the top of the unit.
- Do not use oil, solvents, gasoline, paint thinners or insecticides on the unit.
- Do not expose the unit to moisture, to temperatures higher than 140°F (60°C) or to extreme low temperatures.
- Keep the unit away from direct sunlight, strong magnetic fields, excessive dust, humidity and electronic/electrical equipment (home computers, facsimiles, etc.) which generate electrical noise.
- Hold the AC power plug by the head when removing it from the AC outlet, since pulling the cord can damage internal wires.
- Do not remove the outer cover, as this may result in electric shock.  
Refer internal service to your local SHARP service facility.
- Use the unit on a firm, level surface free from vibration, and do not place anything on the top of the unit.
- If the unit malfunctions while in use, press the ON/STANDBY button to enter the stand-by mode, then disconnect the AC power cord from the AC outlet. Plug the AC power cord back in, and then press the ON/STANDBY button to turn the power on.
- If an electrical storm is taking place near you, it is suggested that you disconnect the AC power cord from the AC outlet for safety.

### Warning:

- The voltage used must be the same as that specified on this unit. Using this product with a higher voltage other than that which is specified is dangerous and may result in a fire or other type of accident causing damage. SHARP will not be held responsible for any damage resulting from use of this unit with a voltage other than that which is specified.

### ■ Care of compact discs

Compact discs are fairly resistant to damage, however mistracking can occur due to an accumulation of dirt on the disc surface.

Follow the guidelines below for maximum enjoyment from your CD collection and player.

- Do not write on either side of the disc, particularly the non-label side.  
Signals are read from the non-label side. Do not mark this surface.
- Keep your discs away from direct sunlight, heat, and excessive moisture.
- Always hold the CDs by the edges. Fingerprints, dirt, or water on the CDs can cause noise or mistracking. If a CD is dirty or does not play properly, clean it with a soft, dry cloth, wiping straight out from the center, along the radius.

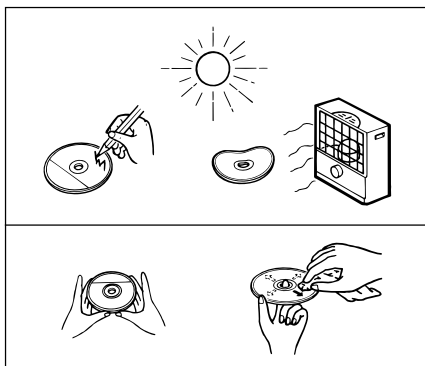

### ■ Volume control

The sound level at a given volume setting depends on a combination of speaker efficiency, location and various other factors.

It is advisable to avoid exposure to high volume levels, which occur while turning the unit on with the volume control setting up high, or while continually listening at high volumes.

### ■ Condensation

Sudden temperature changes, storage or operation in an extremely humid environment may cause condensation inside the cabinet (CD pickup, MiniDisc pickup, etc.) or on the transmitter LED on the remote control.

Condensation can cause the unit to malfunction.

If this happens, leave the power on with no disc in the unit until normal playback is possible (about 1 hour). Wipe off any condensation on the remote control transmitter LED with a soft cloth before operating the unit.

# NAMES OF CONTROLS AND INDICATORS

## ■ Front panel

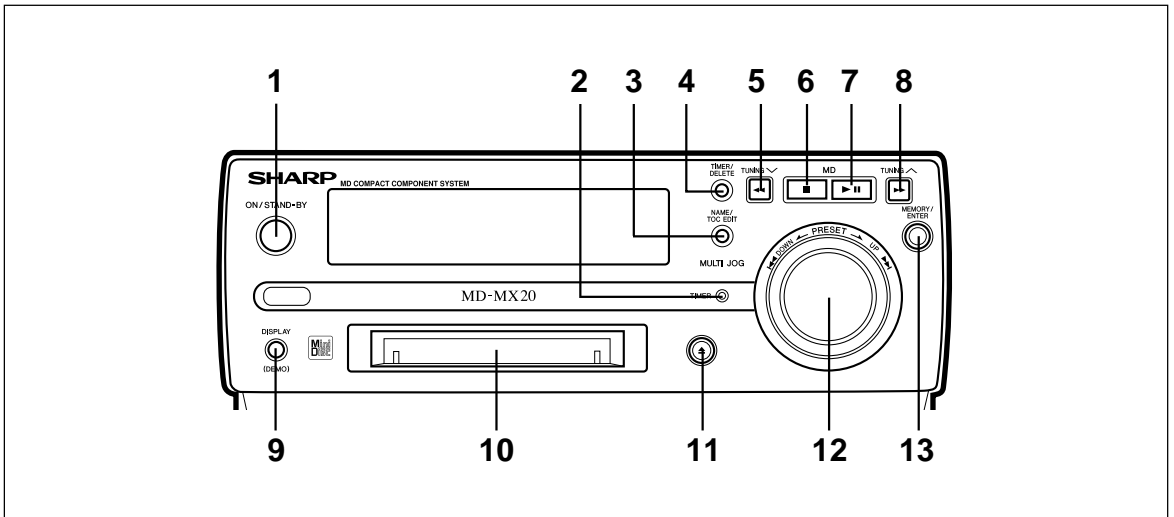

- |                              |                          |                         |
|------------------------------|--------------------------|-------------------------|
| 1. On/Stand-by Button        | 6. MD Stop Button        | 11. MD Eject Button     |
| 2. Timer Stand-by Indicator  | 7. MD Play/Pause Button  | 12. Jog Dial            |
| 3. Name/TOC Edit Button      | 8. Tuning Up/Cue Button  | 13. Memory/Enter Button |
| 4. Timer/Delete Button       | 9. Display (Demo) Button |                         |
| 5. Tuning Down/Review Button | 10. MD Compartment       |                         |

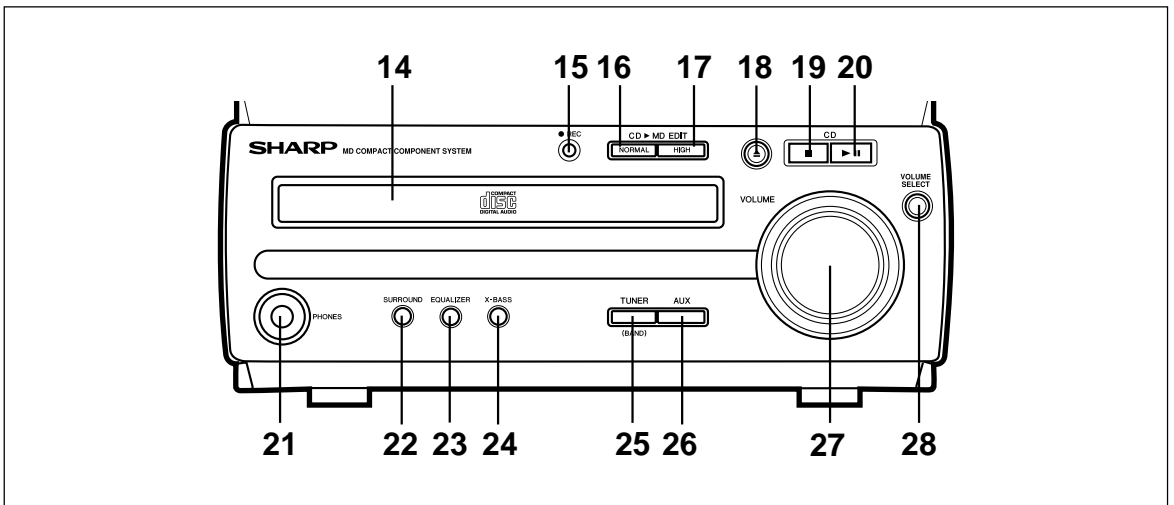

- |                                      |                             |                          |
|--------------------------------------|-----------------------------|--------------------------|
| 14. CD Compartment                   | 18. CD Open/Close Button    | 24. Extra Bass Button    |
| 15. Record Button                    | 19. CD Stop Button          | 25. Tuner (Band) Button  |
| 16. CD ► MD Normal Speed Edit Button | 20. CD Play/Pause Button    | 26. Auxiliary Button     |
| 17. CD ► MD High Speed Edit Button   | 21. Headphone Jack          | 27. Volume Control       |
|                                      | 22. Surround Button         | 28. Volume Select Button |
|                                      | 23. Preset Equalizer Button |                          |

## (Continued)

### ■ Display window

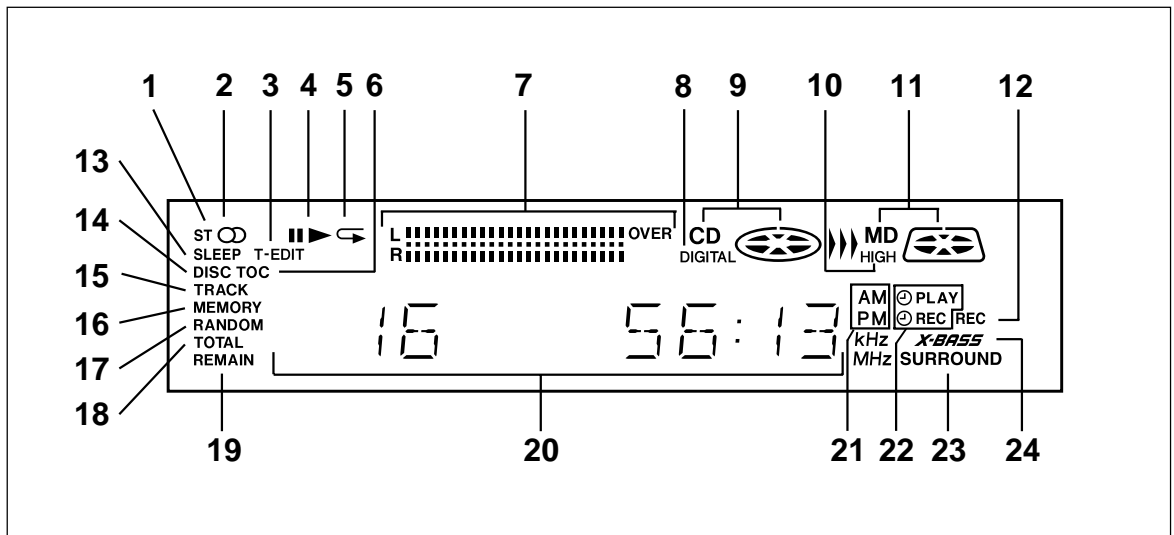

- |                                |                                   |                                       |
|--------------------------------|-----------------------------------|---------------------------------------|
| 1. FM Stereo Indicator         | 11. MD Indicator                  | 21. AM/PM Indicator                   |
| 2. FM Stereo Mode Indicator    | 12. Record Indicator              | 22. Timer Record/Timer Play Indicator |
| 3. Track Edit Indicator        | 13. Sleep Indicator               | 23. Surround Indicator                |
| 4. Play/Pause Indicator        | 14. Disc Indicator                | 24. Extra Bass Indicator              |
| 5. Repeat Indicator            | 15. Track Indicator               |                                       |
| 6. TOC Indicator               | 16. Memory Indicator              |                                       |
| 7. Level Meters                | 17. Random Play Indicator         |                                       |
| 8. Digital Recording Indicator | 18. Total Time Indicator          |                                       |
| 9. CD Indicator                | 19. Remaining Time Indicator      |                                       |
| 10. High Speed Edit Indicator  | 20. Character Information Display |                                       |

### ■ Rear panel

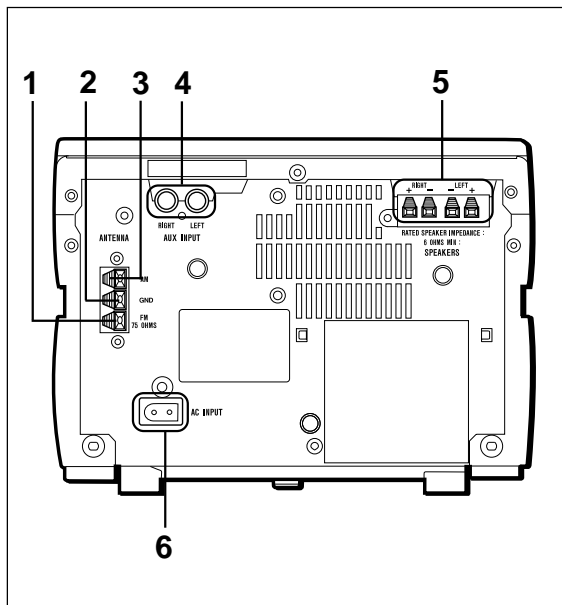

1. FM 75 Ohms Antenna Terminal
2. Antenna Ground Terminal
3. AM Loop Antenna Terminal
4. Auxiliary Input Jacks
5. Speaker Terminals
6. AC Power Input Jack

■ Remote control

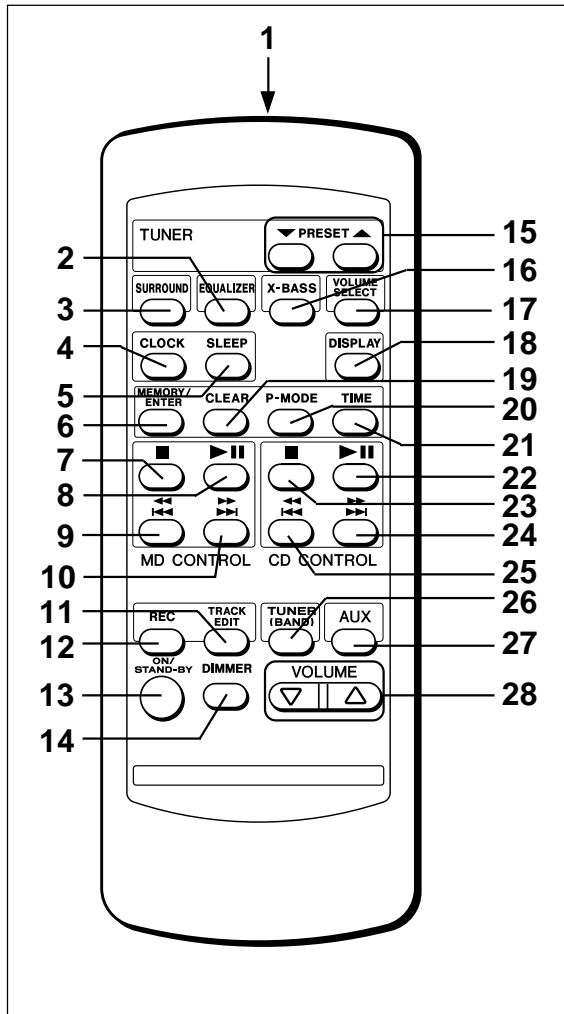

1. Remote Control Transmitter LED
2. Preset Equalizer Button
3. Surround Button
4. Clock Button
5. Sleep Button
6. Memory/Enter Button
7. MD Stop Button
8. MD Play/Pause Button
9. MD Track Down/Review Button
10. MD Track Up/Cue Button
11. Track Edit Button
12. Record Button
13. On/Stand-by Button
14. Dimmer Button
15. Tuner Preset Up/Down Buttons
16. Extra Bass Button
17. Volume Select Button
18. Display Button
19. Clear Button
20. Play Mode Button
21. Time Button
22. CD Play/Pause Button
23. CD Stop Button
24. CD Track Up/Cue Button
25. CD Track Down/Review Button
26. Tuner (Band) Button
27. Auxiliary Button
28. Volume Buttons

■ Speaker section

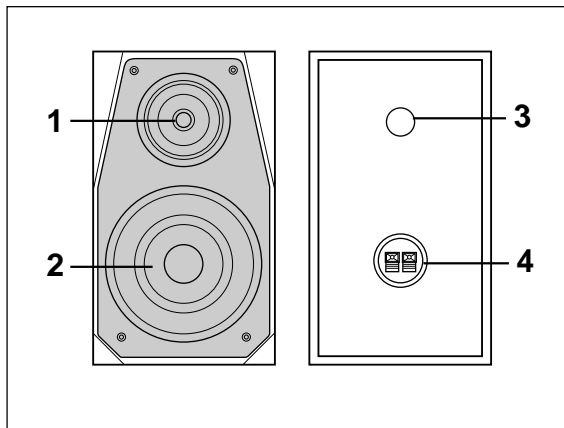

1. Tweeter
2. Woofer
3. Bass Reflex Duct
4. Speaker Terminals



## PREPARATION FOR USE

**Unplug the AC power cord from the AC outlet before connecting or disconnecting any component.**

### ■ Antenna connection

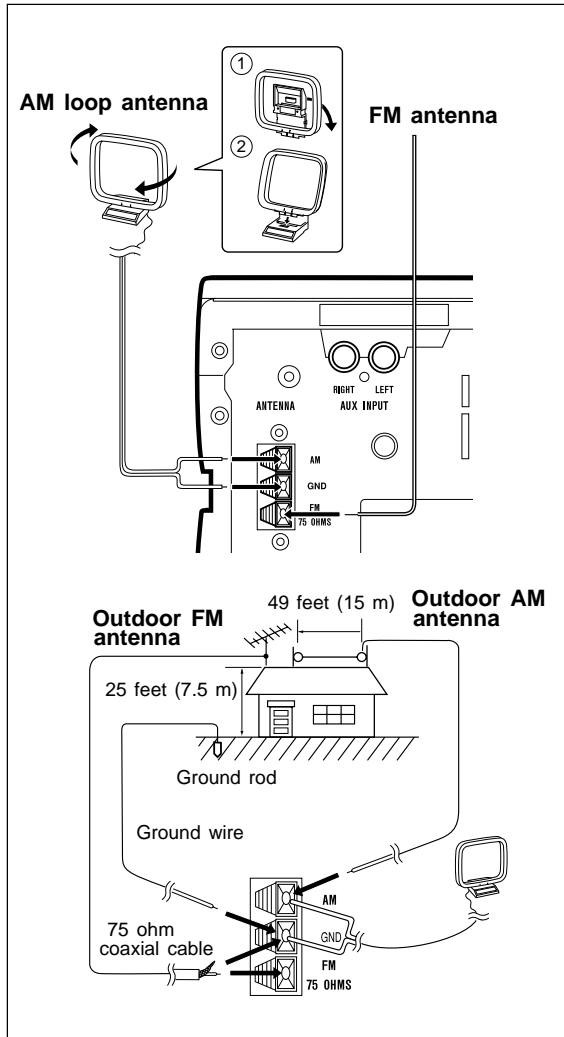

#### Supplied FM antenna

Connect the FM antenna wire to the FM 75 OHMS terminal and position the FM antenna wire in the direction where the strongest signal can be received.

#### Supplied AM loop antenna

Connect the AM loop antenna wire to the AM and GND terminals.

Position the AM loop antenna for optimum reception. Place the AM loop antenna on a shelf, etc., or attach it to a stand or a wall with screws (not supplied).

#### Notes:

- When static is still heard even after adjusting the position of the AM loop antenna, try reversing the wire connections.
- Do not place the AM loop antenna and the FM antenna wire on the unit. It may result in noise generation, since the unit is equipped with digital electronics. Place the AM loop antenna and the FM antenna wire away from the unit for better reception.
- If the AM loop antenna and the FM antenna wire are placed near the AC power cord, interference may result.

#### Outdoor FM antenna

Use an outdoor FM antenna (75 ohm coaxial cable) if you require better reception. Consult your dealer.

#### Note:

- When an outdoor FM antenna is used, disconnect the supplied FM antenna wire from the FM 75 OHMS terminal.

#### Outdoor AM antenna

Use an outdoor AM antenna if you need better reception. Consult your dealer.

#### Note:

- When using an outdoor AM antenna, be sure to keep the wire of the AM loop antenna connected.

### ■ Speaker connection

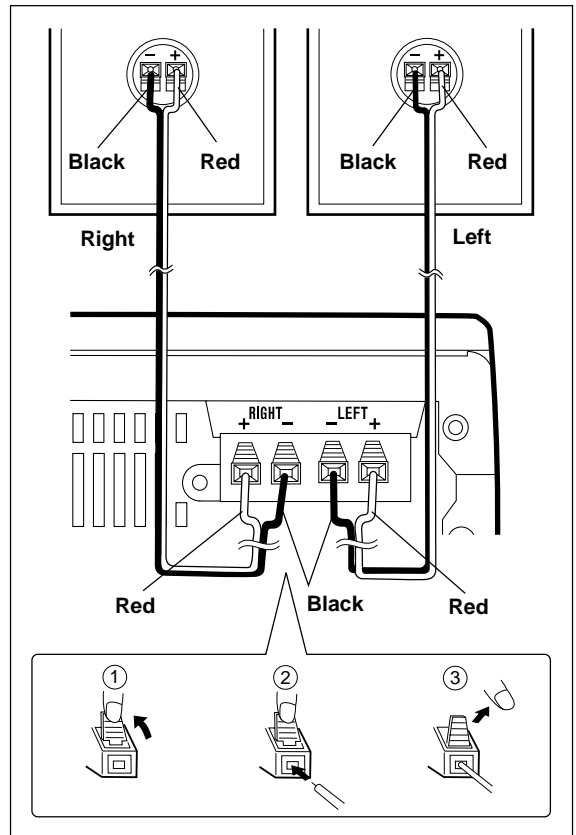

Connect each speaker wire to the SPEAKER terminals as shown.

Use speakers with an impedance of 6 ohms or more, as lower impedance speakers can damage the unit.

#### Caution:

- Before connecting the speakers to the unit, connect the speaker wires to the speakers first. Then, connect the speaker wires to the terminals on the unit.
- Connect the speakers to the main unit before you use the system. If the speakers are not connected before operation, the system may be damaged.

#### Notes:

- Connect the black wire to the minus (-) terminal, and the red wire to the plus (+) terminal.
- Do not mix the right channel and left channel wiring when connecting the speakers to the unit.
- Do not let bare speaker wires touch each other as this may damage the amplifier and/or speakers.

### ■ Removing the speaker grilles

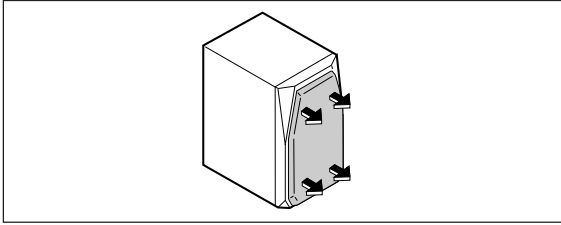

**1** Remove the lower part of the speaker grille first.

**2** Remove the upper part of the speaker grille.

**Caution:**

When the speaker grilles are removed, the speaker diaphragms are exposed. Make sure nothing comes into contact with the speaker diaphragms.

### ■ Placing the system

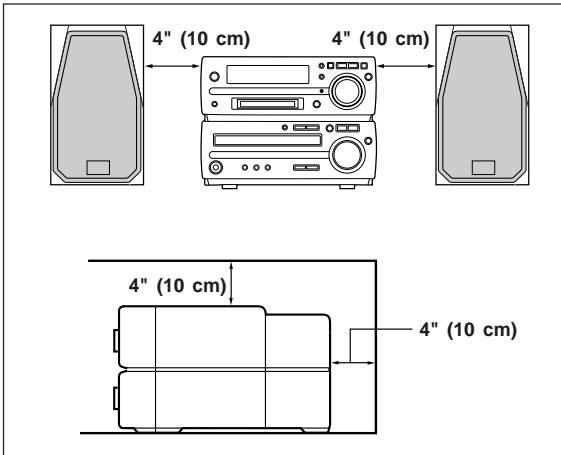

Be sure to keep space between the units for ventilation. Keep the top and the back of this unit at least 4" (10 cm) away from the wall.

### ■ Connecting the AC power cord

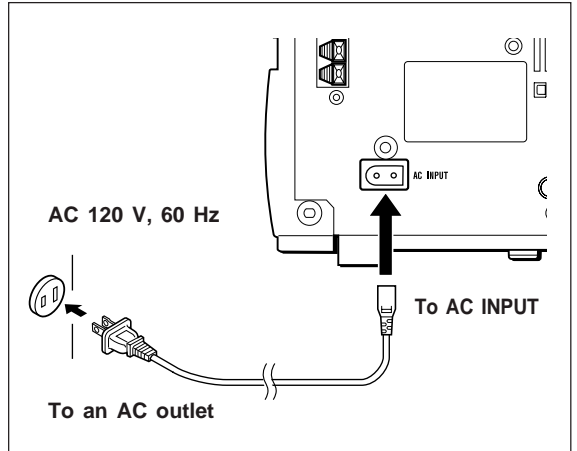

Connect the AC power cord to the AC INPUT jack, then connect its plug to an AC outlet.

**Notes:**

- Unplug the AC power cord from the AC outlet if the unit will not be in use for a prolonged period of time.
- Never use a power cord other than the one supplied. Use of a power cord other than the one supplied may cause an electric shock or fire.

### ■ Demo mode

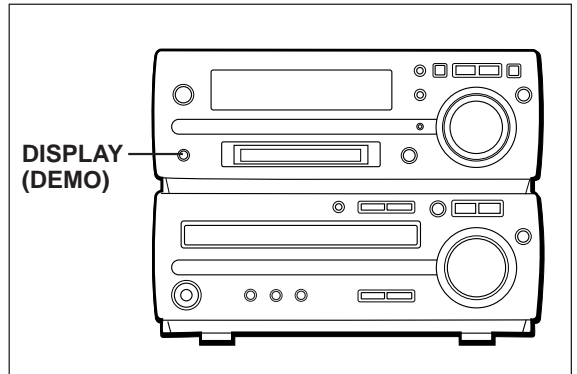

When the AC power cord is first connected, the unit will enter the demonstration mode and the words will scroll across the display continuously.

**To cancel the demonstration mode:**

When in the demonstration mode, press the DISPLAY (DEMO) button.

- The demonstration mode will be canceled and the unit will be in the low power consumption mode.

**Note:**

- When the unit is in the low power consumption mode, the display will disappear.

### ■ Remote control

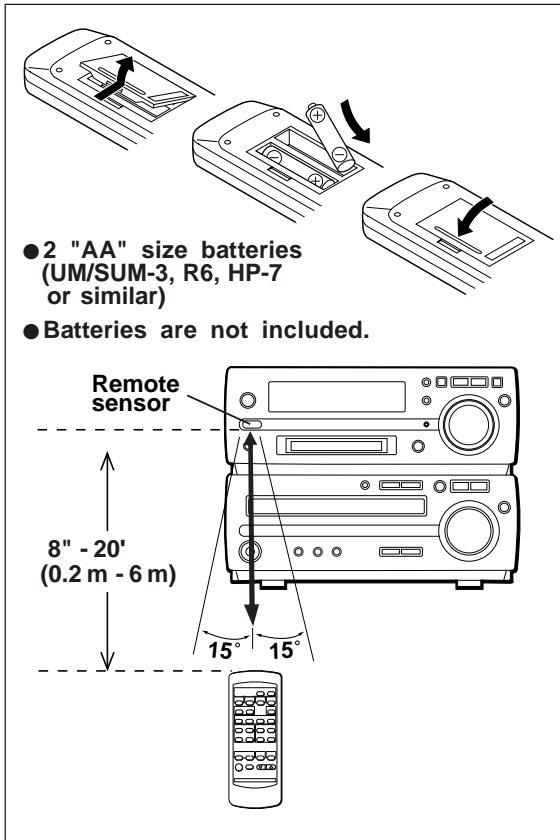

- When inserting or removing the batteries, push them toward the  $\ominus$  battery terminal.
- Installing the batteries incorrectly may cause the unit to malfunction.

#### Precautions for battery use:

- Insert the batteries according to the direction indicated in the battery compartment.
- Replace all old batteries with new ones at the same time.
- Do not mix old and new batteries.
- Remove the batteries if they are weak or if the unit will not be used for long periods of time. This will prevent potential damage due to battery leakage.

#### Caution:

Do not use rechargeable batteries (nickel-cadmium battery, etc.).

#### Notes concerning use:

- Replace the batteries if the operating distance is reduced or if the operation becomes erratic.
- Periodically clean the transmitter LED on the remote control and the sensor on the main unit with a soft cloth.
- Exposing the sensor on the main unit to strong light may interfere with operation. Change the lighting or the direction of the unit.
- Keep the remote control away from moisture, excessive heat, shock, and vibrations.

### ■ To change the brightness of the display

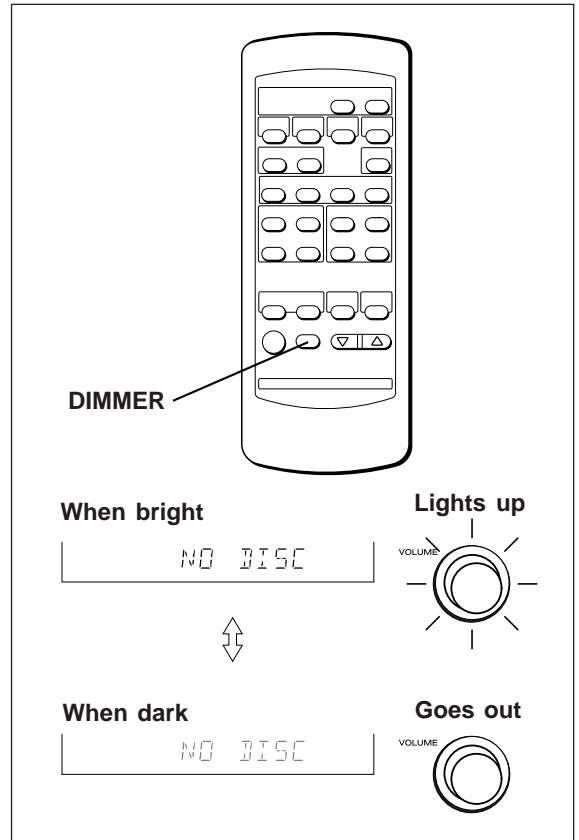

- 1 Press the ON/STAND-BY button to turn the power on.
- 2 Press the DIMMER button.
  - The display will become dimmer and the light around the VOLUME control will go out.

#### To return to the original brightness:

Press the DIMMER button again.

## SETTING THE CLOCK

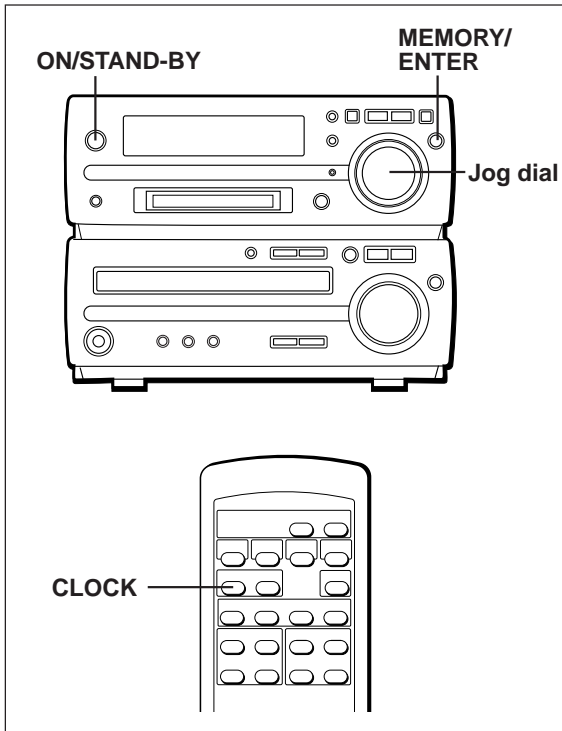

- In this example, the clock is set for the 24-hour (0:00) system.

**1** Press the ON/STAND-BY button to turn the power on.

**2** Press the CLOCK button.



**3** Within 5 seconds, press the MEMORY/ENTER button.

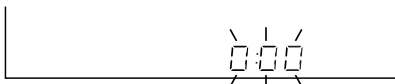

**4** Turn the jog dial to select the time display mode.

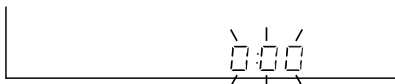

"0:00" → The 24-hour display will appear.  
(0:00 - 23:59)

"12:00 AM" → The 12-hour display will appear.  
(AM or PM 12:00 - 11:59)

"0:00 AM" → The 12-hour display will appear.  
(AM or PM 0:00 - 11:59)

- Note that this can only be set when the unit is first installed or it has been reset (see page 38).

**5** Press the MEMORY/ENTER button.

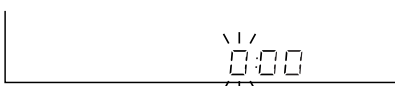

**6** Adjust the hour by turning the jog dial.

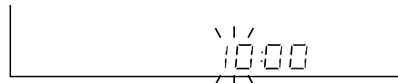

- When the jog dial is turned one click clockwise, the time will increase by 1 hour. When it is turned one click counterclockwise, the time will decrease by 1 hour. Keep turning the jog dial to change the time continuously.
- When the 12-hour display is selected, "AM" will change automatically to "PM".

**7** Press the MEMORY/ENTER button.

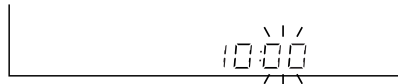

**8** Adjust the minutes by turning the jog dial.

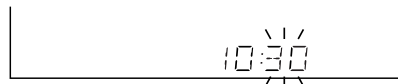

- When the jog dial is turned one click clockwise, the time will increase by 1 minute. When it is turned one click counterclockwise, the time will decrease by 1 minute. Keep turning the jog dial to change the time continuously.
- The hour setting will not advance even if minutes advance from "59" to "00".

**9** Press the MEMORY/ENTER button.

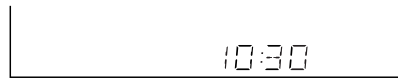

- The clock starts operating from "0" second. (Seconds are not displayed.)

### To see the time display:

Press the CLOCK button.

- The time display will appear for about 5 seconds even in the stand-by mode.

### Note:

- The "CLOCK" will appear at the push of the CLOCK button when the AC power supply is restored after a power failure occurs or after the AC power cord is disconnected. If this happens, follow the procedure below to change the clock time.

### To change the clock time:

- ① Press the CLOCK button.
- ② Within 5 seconds, press the MEMORY/ENTER button.
- ③ Perform steps 6 - 9 above.

### To change the time display mode:

- ① Reset the microcomputer (see page 38).
- ② Perform steps 2 - 9 above.

# SOUND CONTROL

## Volume

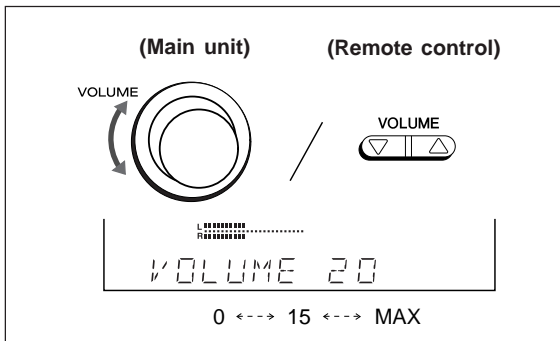

(Main unit operation)

When the **VOLUME** control is turned clockwise, the volume will increase. When it is turned counterclockwise, the volume will decrease.

(Remote control operation)

Press the **VOLUME**  $\Delta$  button to increase the volume and the **VOLUME**  $\nabla$  button to decrease the volume.

### Servo Powered Volume:

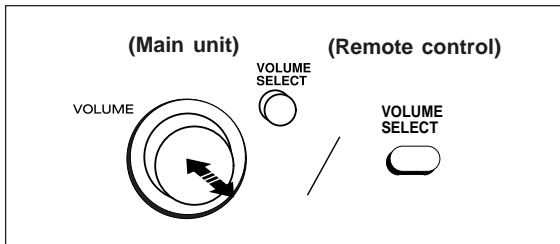

The **VOLUME** control automatically comes out when the power is turned on, and goes back when the unit is set to the stand-by mode.

- When the power is turned on, you can put the **VOLUME** control in and out by pressing the **VOLUME SELECT** button.

**Note:**

- Do not push in the **VOLUME** control forcibly with your finger as this may damage the unit.

## Pre-programmed equalizer

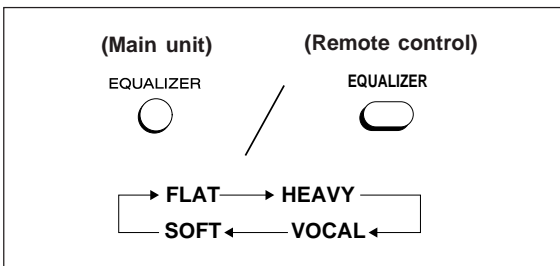

When the **EQUALIZER** button is pressed, the current mode setting will be displayed. To change to a different mode, press the **EQUALIZER** button repeatedly.

**FLAT:** The sound is not modified.

**HEAVY:** Bass and treble are emphasized.

**VOCAL:** Vocals (midrange tones) are emphasized.

**SOFT:** Treble is reduced.

## Extra bass (X-BASS)

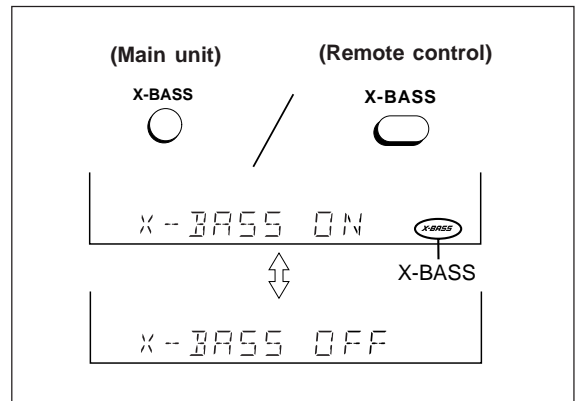

Press the **X-BASS** button to emphasize the bass region of the frequency spectrum.

- "X-BASS ON" will appear.

Press the **X-BASS** button again to cancel the extra bass mode.

- "X-BASS OFF" will appear.

**Note:**

- Turn the **X-BASS** to the off position when playing the unit at high volume levels to avoid speaker distortion.

## Surround

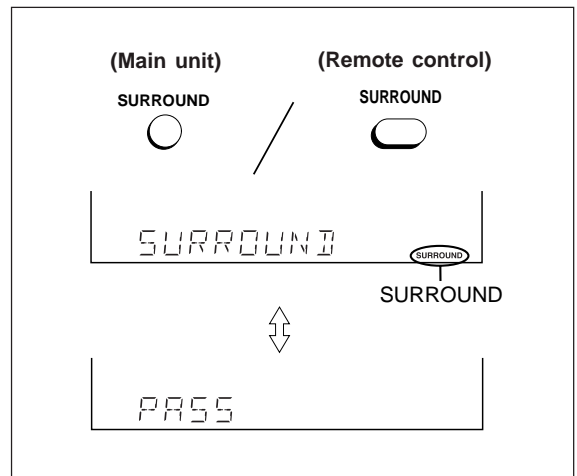

Press the **SURROUND** button to widen the soundstage and surround you with sound.

- "SURROUND" will appear.

Press the **SURROUND** button again to cancel the surround mode.

- "PASS" will appear.

# COMPACT DISC OPERATION

## ■ CD playback

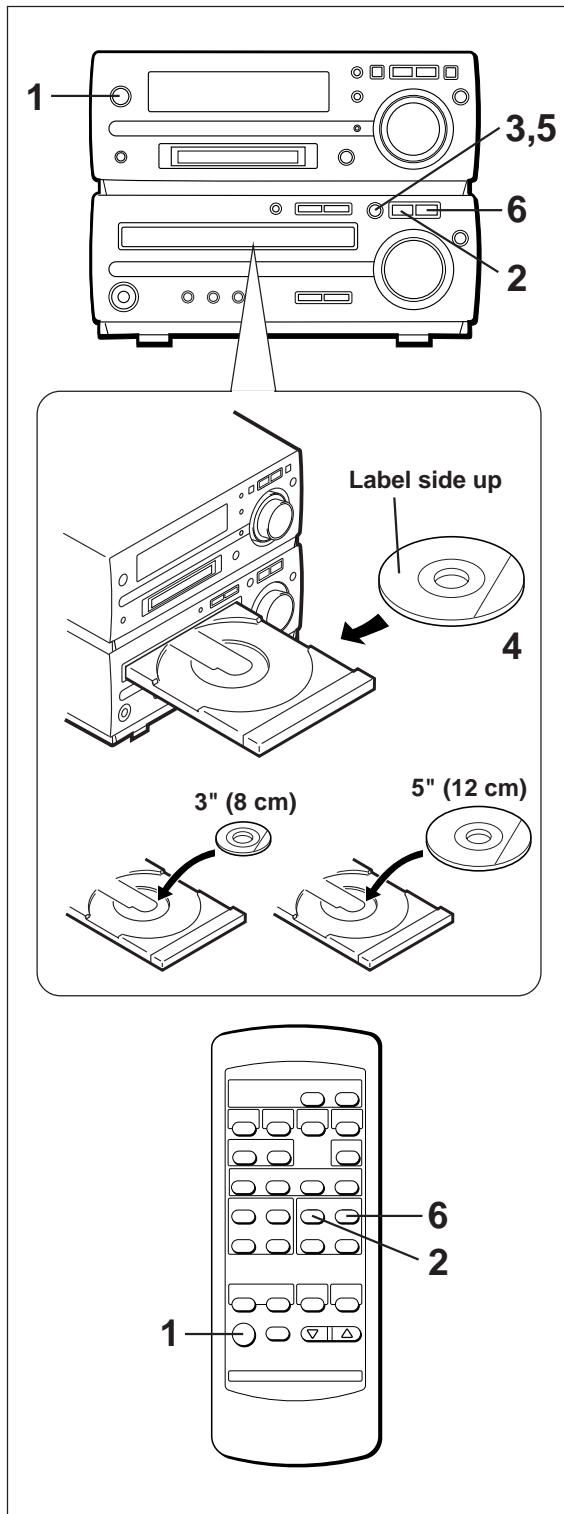

**1** Press the ON/STAND-BY button to turn the power on.

**2** Press the CD ■ button.

**3** Press the ▲ button to open the disc tray.

**4** Place the CD on the disc tray, label side up.

- Be sure to place 3" (8 cm) CD in the middle of the disc tray.

**5** Press the ▲ button to close the disc tray.

- The total number of tracks and the total playing time will be displayed.

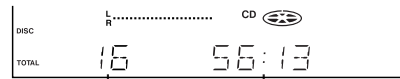

Total number of tracks      Total playing time

**6** Press the CD ►|| button to start playback from track 1.

- When the last track has been played back, the unit will stop automatically.

### To interrupt playback:

Press the CD ►|| button.

- "||" will appear.

- Press the CD ►|| button again to resume playback from the same point.

### To stop playback:

Press the CD ■ button.

### To remove the CD.

Press the ▲ button.

### After use:

Press the ON/STAND-BY button to enter the stand-by mode.

### Caution:

- Do not carry the unit with a CD left in the disc tray. The disc may come loose inside the unit and it may be damaged or cause damage to the unit. This may also cause malfunctions.

- Do not push the disc tray while it is moving.

- If the power fails while the tray is open, wait until the power is restored.

- If the disc tray is stopped forcibly, "E-CD20" will appear in the display and the unit will not function.

If this occurs, press the ON/STAND-BY button to enter the stand-by mode and then turn the power on again.

- Subjecting the unit to shock or vibration may cause mistracking.

- Playing certain CDs at a high volume may cause mistracking. In this case, listen at a lower volume.

- If TV or radio interference occurs during CD operation, move the unit away from the TV or radio.

# MINIDISC OPERATION

## ■ MiniDisc playback

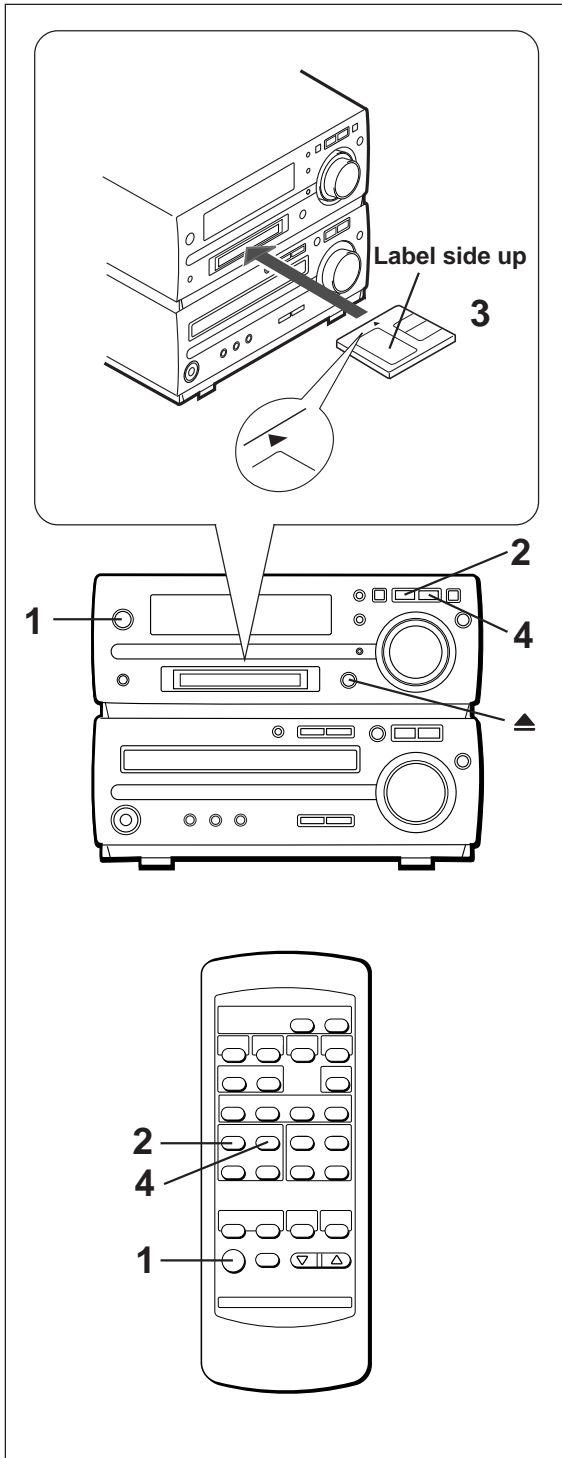

**1** Press the ON/STAND-BY button to turn the power on.

**2** Press the MD ■ button.

**3** Load a MiniDisc in the direction indicated by the arrow on the MiniDisc, with the labeled side facing up.

- The disc name will be displayed only when the name has been programmed onto the disc.

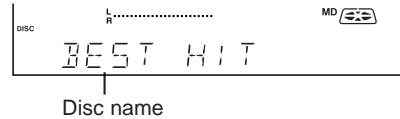

- The total number of tracks and the total playing time on the MiniDisc will be displayed.

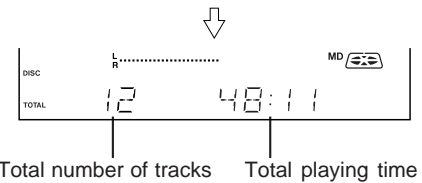

**4** Press the MD ►|| button.

- If the track name has been programmed on the MiniDisc, it will appear and scroll across the display.
- If the MiniDisc has no track names, only the elapsed playing time will appear.
- When the last track has been played back, the unit will stop automatically.

### To interrupt playback:

Press the MD ►|| button.

- " || " will appear.
- Press the MD ►|| button again to resume playback from the same point.

### To stop playback:

Press the MD ■ button.

### To remove a MiniDisc:

Press the ▲ button.

### Caution:

- Do not carry the unit with a MiniDisc left in the MD compartment. The disc may come loose inside the unit and it may be damaged or cause damage to the unit. This may also cause malfunctions.
- If TV or radio interference occurs when using the MiniDisc, move the unit away from the TV or radio.
- Although MiniDiscs will not normally skip due to vibration, you may hear skipping in the sound if there is continuous vibration. If the volume is turned up too high, sound skipping may occur depending on the contents of the MiniDisc. If this happens, turn the volume down and the skipping should stop.
- If an error message is displayed during MiniDisc operation, see "ERROR MESSAGES" on page 39.

## CONVENIENT CD AND MINIDISC OPERATIONS

### ■ APSS (Auto Program Search System)

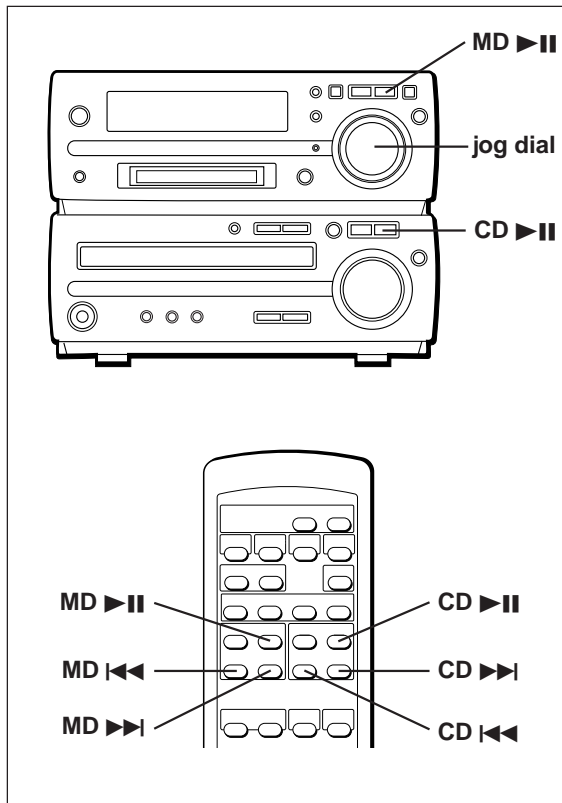

#### To listen again to the track being played:

(Main unit operation)

Turn the jog dial counterclockwise during playback.

(Remote control operation)

Press the CD ◀◀ or MD ◀◀ button for less than 0.5 seconds during playback.

#### To move to the beginning of the next track:

(Main unit operation)

Turn the jog dial clockwise during playback.

(Remote control operation)

Press the CD ▶▶ or MD ▶▶ button for less than 0.5 seconds during playback.

- To skip a number of tracks at one time, turn the jog dial on the main unit or press the CD ◀◀ / ▶▶ or MD ◀◀ / ▶▶ button on the remote control repeatedly until the desired track number is shown.
- To start continuous playback from a desired track, select the track number by turning the jog dial on the main unit, or by pressing the CD ◀◀ / ▶▶ or MD ◀◀ / ▶▶ button on the remote control, while in the stop mode. Then, press the CD ▶|| or MD ▶|| button.

### ■ Cue and review

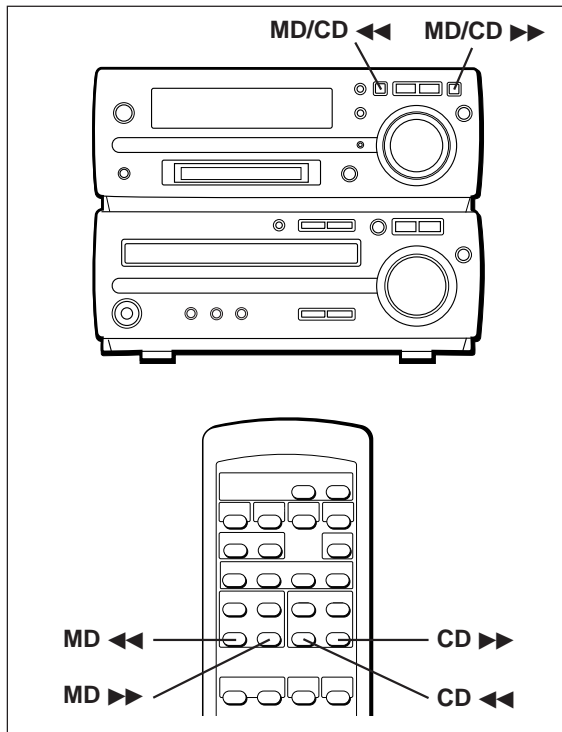

**1** Load a disc and begin playback.

**2** Hold the MD/CD ▶▶ button down for audible fast forward, and hold the MD/CD ◀◀ button down for audible fast reverse.

**3** Normal playback will resume when the button is released.

#### Notes:

- When the end of the last track is reached, "END" will light, and the unit will pause. If you want to listen to a portion of a track again, press the MD/CD ◀◀ button to return to the point in the track you want to listen to.
- If the beginning of the disc is reached while reviewing, playback will start automatically.

#### To search very quickly:

When fast forward or fast reverse is used while in the pause mode, the playback point will move more quickly than when using audible fast forward or audible fast reverse playback.

- In this mode, no sound is heard. Therefore, you should refer to the time display.
- When you lift your finger, the unit will re-enter the pause mode.



**(Continued)**

**■ APMS (Automatic Programmable Music Selector)**

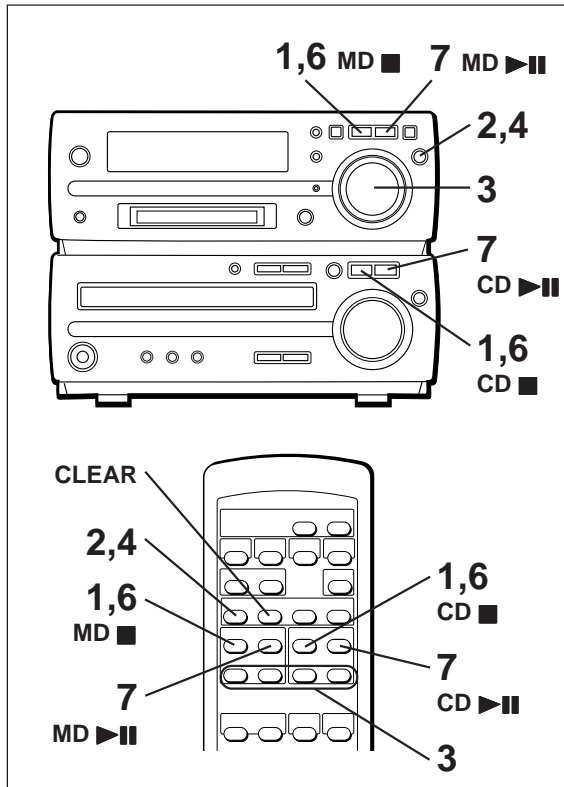

**1** (CD operation)

Press the **CD** button.

(MiniDisc operation)

Press the **MD** button.

**2** Press the **MEMORY/ENTER** button.



**3** Turn the jog dial or press the **CD** or **MD** button to choose the track number you wish to program into memory.

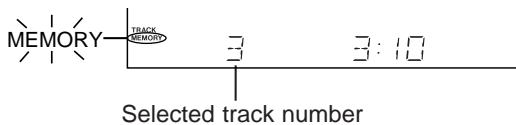

**4** Press the **MEMORY/ENTER** button.

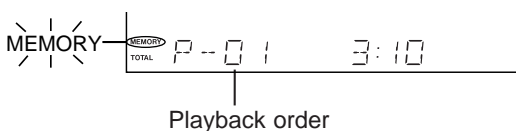

**5** Repeat steps 3 and 4 for any other tracks. Up to 20 tracks (P-20) can be programmed.

**6** (CD operation)

To complete programming, press the **CD** button.

(MiniDisc operation)

To complete programming, press the **MD** button.

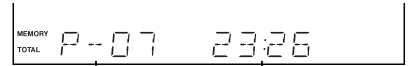

Total number of tracks      Total playing time

**7** (CD operation)

To begin playback of your programmed selections, press the **CD** button to start playback of the programmed selections.

(MD operation)

To begin playback of your programmed selections, press the **MD** button to start playback of the programmed selections.

- After all of the programmed tracks have finished playback, the unit will automatically stop.

**To clear the programmed selections:**

Press the **CLEAR** button while the "MEMORY" indicator is flashing.

- Each time the button is pressed, one track will be cleared, beginning with the last track programmed.

**To cancel the APMS:**

While the unit is stopped in the APMS mode, press the **CLEAR** button to turn off the "MEMORY" display.

- The program contents will be erased.
- When you open the disc tray or eject a MiniDisc, the APMS mode will be canceled.

**To check which tracks are programmed:**

While the unit is stopped in the APMS mode, turn the jog dial or press the **CD** or **MD** button.



Track number      Playback order

**Adding tracks to the program:**

If a program has been previously stored, the "MEMORY" indicator will be displayed. Then follow steps 2 - 6 to add additional tracks. The new tracks will be stored after the last track of the original program.

**Notes:**

- It is not possible to insert an additional track between programmed tracks that have already been entered.
- Programming and canceling are not possible during playback or in the pause mode.

## Repeat and random play

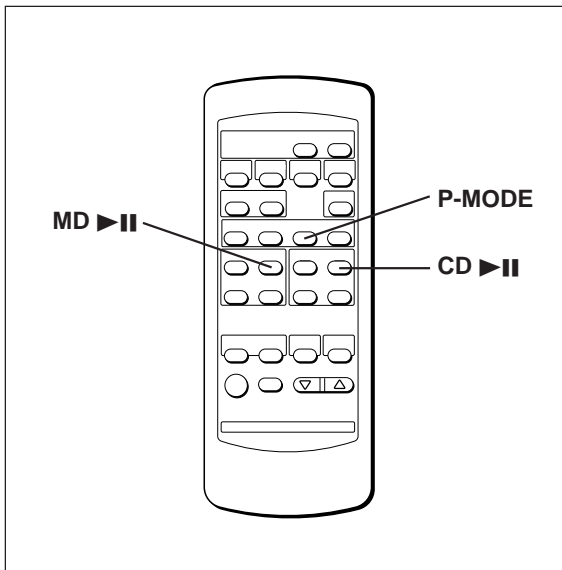

**1** Select the desired program source, CD or MiniDisc.

**2** Press the P-MODE (play mode) button.

- Each time this button is pressed, the mode will change in the following order:

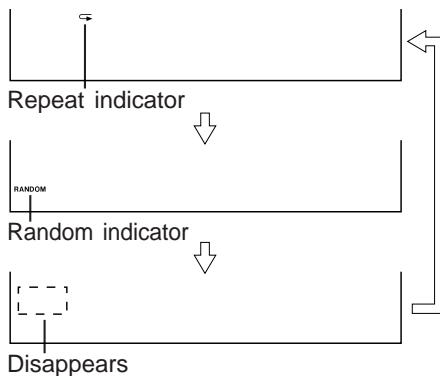

**3** Press the CD or MD button to start playback.

### Repeat play

After the last track has been played, playback will return to the first track and begin again.

### Random play

When the CD or MD button is pressed, all of the tracks will be played at random, and then playback will stop. (The same track will not be played back twice.)

### To cancel repeat or random play:

Press the P-MODE button until the " " or "RANDOM" display disappears.

### To repeat playback of selected tracks:

Enter the program for the tracks you want and start repeat play.

You can program a single track and play it repeatedly (refer to page 16).

### Notes:

- If you press the CD or MD button during random play, you can move to the next track. On the other hand, the CD or MD button does not allow you to move to the previous track. The beginning of the track being played will be located.
- During APMS play, random play is not possible.
- When random or repeat play is selected during CD or MiniDisc playback, random or repeat play will start at that point.
- When using repeat play, be sure to press the CD or MD button after you have finished listening. Otherwise, the disc will play continuously.

### ■ Switching the time display

Each time the TIME button is pressed during playback or when in the pause mode, the display will change.

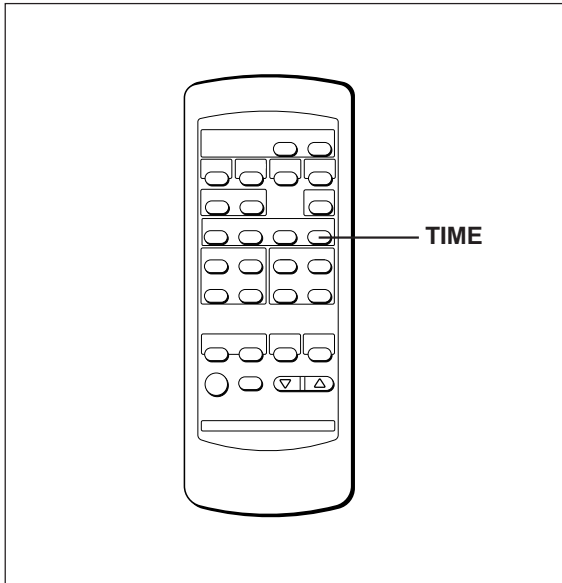

- 1 The elapsed playing time for the current track will be displayed.



- 2 The remaining playing time for the current track will be displayed.



- 3 The total remaining playing time for the disc from the point being played at that time will be displayed.

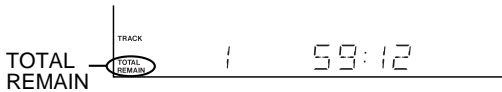

**Notes:**

- During random play, the total remaining playing time will not be displayed.
- Depending on a CD or MiniDisc to be played, the playing time display may not match the total playing time which is indicated on the CD or MiniDisc jacket, as the time between the tracks is not included.

### ■ Changing the display during MiniDisc playback

Each time the DISPLAY button is pressed during playback or when in the pause mode, the display will change as described below.

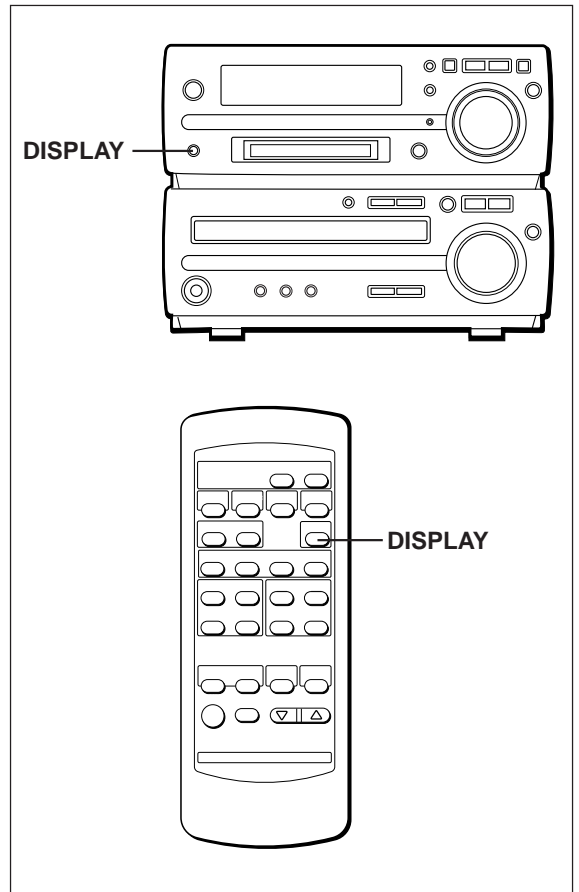

- 1 The track name will be displayed.

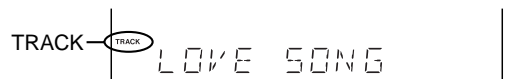

- When the MiniDisc does not have a track name, this display does not appear.

- 2 The total number of tracks and the remaining recording time will be displayed.

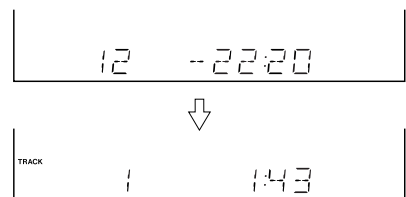

# RADIO OPERATION

## ■ Tuning

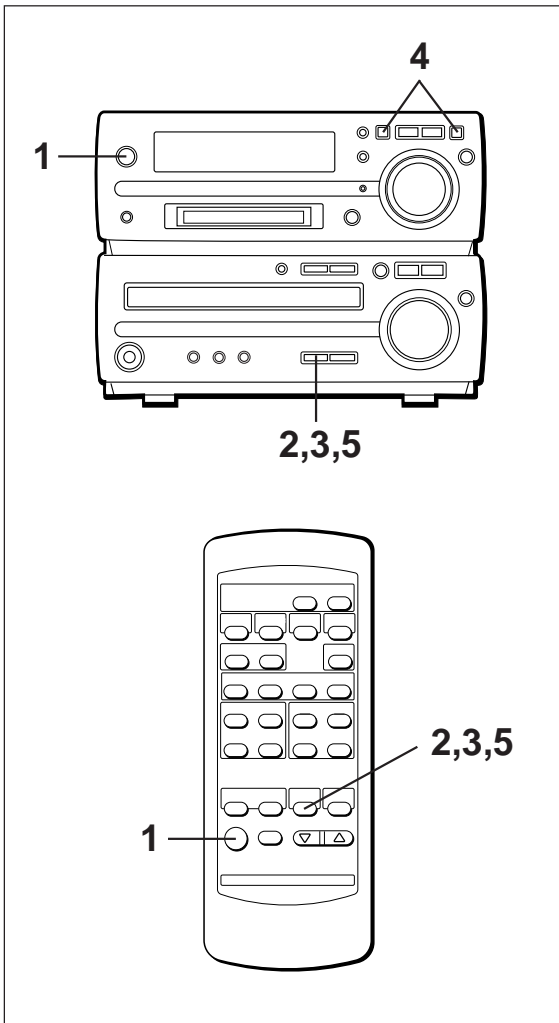

- 1** Press the ON/STAND-BY button to turn the power on.
- 2** Press the TUNER (BAND) button.
- 3** Press the TUNER (BAND) button to select the desired frequency band (FM ST, FM or AM).

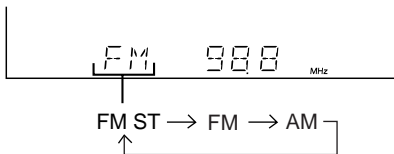

- 4** Press the TUNING (∨ or ∧) button to tune into the desired station.

### Manual tuning:

Press the TUNING (∨ or ∧) button as many times as required to adjust the frequency shown on the display to the frequency of the desired station.

### Auto tuning:

When the TUNING (∨ or ∧) button is pressed for more than 0.5 seconds, scanning will start automatically and the tuner will stop at the first receivable broadcast station.

- When radio interference occurs during auto scan tuning, auto scan tuning may stop automatically at that point.
- If a weak station signal is found during auto scan tuning, the station will be skipped.
- To stop the auto tuning, press the TUNING (∨ or ∧) button again.

- 5** To receive an FM stereo transmission, press the TUNER (BAND) button so that the "ST" indicator on the display lights up.

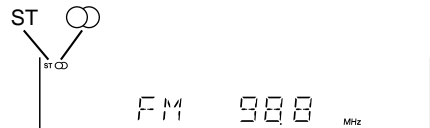

- "∞" will appear when an FM broadcast is in stereo.
- If the FM reception is weak, press the TUNER (BAND) button so that the "ST" indicator goes out.
- The reception changes to monaural, the sound becomes clearer.

### After use:

Press the ON/STAND-BY button to enter the stand-by mode.

### Notes:

- The last station tuned in will be recalled, even after changing the tuning band or the function, or after switching the unit to the stand-by mode.
- If the unit's tuner interferes with the reception of a nearby TV or radio, move the unit as far away from these items as possible.

### ■ Preset tuning

You can store up to 40 stations in memory (40 stations consisting of any combination of AM and FM stations you like) and recall them.

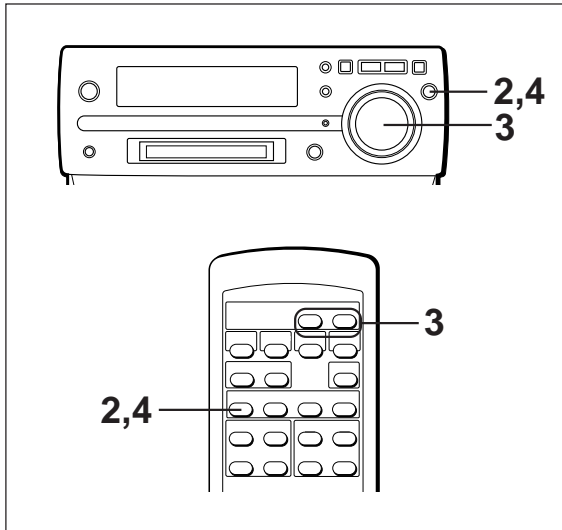

To enter stations into memory:

- 1 Perform steps 1 - 5 in the "Tuning" section.
- 2 Press the MEMORY/ENTER button.

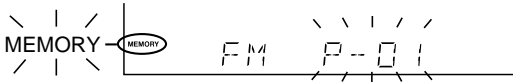

- 3 Within 5 seconds, turn the jog dial or press the PRESET (∨ or ∧) button to make the preset channel number flash in the display.

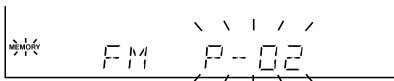

- Store the stations in memory, in order, starting with preset channel 1. When \* is displayed, a station has already been stored in this preset number memory.

- 4 Within 5 seconds, press the MEMORY/ENTER button to store that station in the selected station preset number memory.

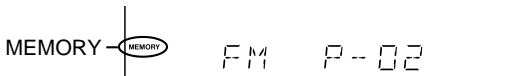

- If the "MEMORY" and preset number indicators go out before the station is memorized, repeat the operation from step 2.

- 5 Repeat steps 1 - 4 to set other stations, or to change a preset station.

- When a new station is stored in the selected station preset number memory location, the previously memorized station in that location will be erased.

### To recall a memorized station:

Turn the jog dial or press the PRESET (∨ or ∧) button for less than 0.5 seconds to select the desired station.

- The stations (preset channel number, frequency and frequency band) which have been stored in memory will appear in the display in numerical order, irrespective of the frequency bands.

### Backup function:

The backup function protects all station presets for a few hours should there be a power failure or the AC power cord is removed from the AC outlet.

### ■ Preset memory scan

The stations saved in the preset memory can be scanned automatically.

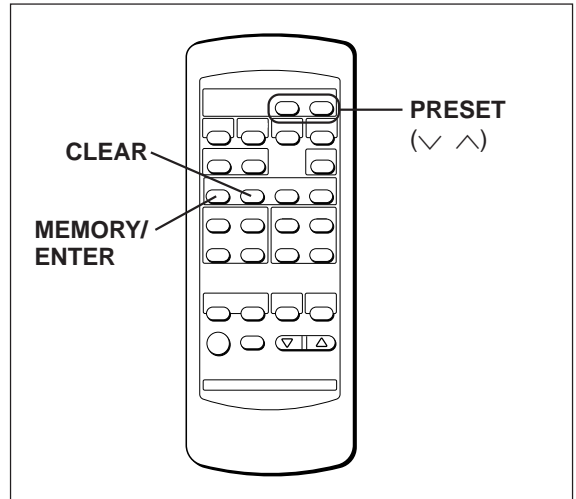

- 1 To scan the preset stations, press the PRESET (∨ or ∧) button for more than 0.5 seconds.

- The station preset number will flash and the programmed stations will be tuned in sequentially, for 5 seconds each.

- 2 Press the PRESET (∨ or ∧) button again to stop the memory scan at the desired station.

### Note:

When the preset memory does not have any stations stored in it, the preset memory scan will not function.

### To erase the memorized station:

- 1 Recall the memorized station to be erased by turning the jog dial or pressing the PRESET (∨ or ∧) button.

- 2 Press the CLEAR button.

- "MEMORY" and preset number will flash.

- 3 Within 5 seconds, press the MEMORY/ENTER button.

- 4 Repeat steps 1-3 to erase other memorized stations.

### To erase all memorized stations:

When the unit is in the stand-by mode, hold down the TUNER (BAND) and the MD ■ buttons, and then press the ON/STAND-BY button.

- "PRESET CLR" will appear.

## MINIDISC RECORDING

### ■ Differences from tape recordings

You cannot record music on the reverse side of a MiniDisc.

MiniDiscs are single sided and should only be inserted with the correct side up in the direction of the arrow on the top of the MiniDisc.

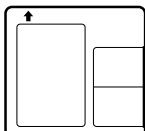

You don't need to search for the starting point at which to record.

The unit automatically finds the point at which recording can start. Recording will start from that point.

You can check the total or remaining recordable time (possible recording) before recording.

This lets you plan a recording session so that the last song will not come to an abrupt end before it has finished.

### ■ Disc writing (TOC)

The TOC (Table of Contents) is information on track numbers and recording areas to allow the unit to recognize musical selections or sounds.

The entire MiniDisc is controlled depending on this TOC, which enables the unit to find the beginning of a track quickly or to automatically record in a vacant area.

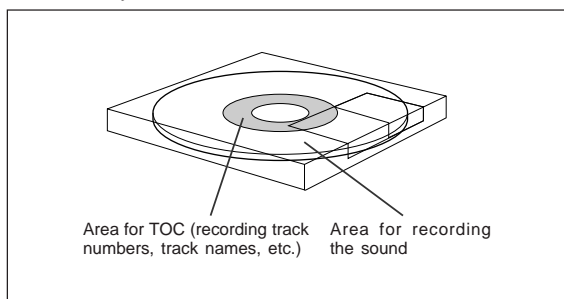

When you start recording or editing, "TOC" will appear in the display window.

This indicates that information in the TOC is now being changed according to the recording or editing being performed. (The changed TOC is not yet recorded on the MiniDisc at this time.)

#### The TOC is recorded when

- you stop recording.
- you switch to another input source.
- you eject the MiniDisc.
- you enter the stand-by mode.

Do NOT unplug the power cord while the TOC is being recorded ("TOC" is flashing) and do NOT impart shock to the unit. Otherwise, TOC will not be correctly recorded, and consequently proper playback may not be possible.

### ■ About track numbers

#### When recording from a CD

New track numbers will be created automatically according to the original tracks (Synchro mark function).

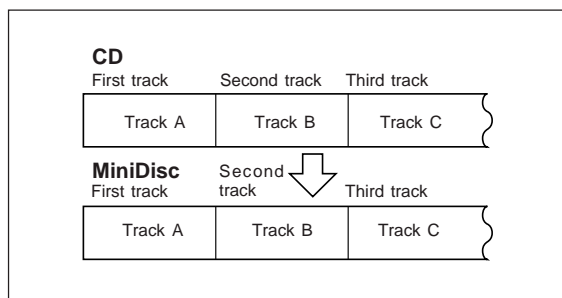

- When you record from a CD to a MiniDisc, the track numbers recorded on the MiniDisc may not match the track numbers on the CD.

If this happens, correct the track numbers using the DIVIDE (page 29) and COMBINE (page 29) functions after recording.

#### Recordings cannot be made in the following situations.

- If you try recording on a playback-only MiniDisc (commercially available music MiniDisc).
- If a MiniDisc is protected against accidental erasure (page 36).
- If there is no more recording time left on the disc (page 37).
- When the "TOC FULL" message appears (page 39).
- If a disc's TOC has been damaged.

#### Notes:

- When recording important selections, be sure to make a preliminary test to ensure that the desired material is being properly recorded.
- The VOLUME, X-BASS, EQUALIZER and SURROUND controls can be adjusted during recording, with no effect on the recorded signal.

### ■ Recording from a CD onto a MiniDisc (One-Touch Editing)

A CD can be recorded to a MiniDisc, starting from the first track, with one-touch operation.

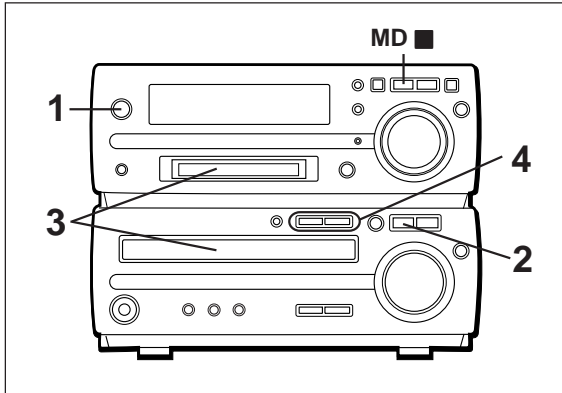

- 1 Press the ON/STAND-BY button to turn the power on.
- 2 Press the CD ■ button.
- 3 Load a CD and a recordable MiniDisc.
- 4 Press the CD ► MD EDIT (HIGH or NORMAL) button.

- The total number of tracks and the total playing time on the CD will be displayed.

- Press the NORMAL button for actual speed, HIGH for high-speed recording.

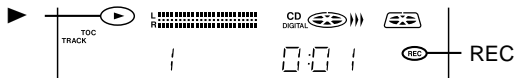

- Recording will begin, starting from the first track of CD.
- After recording (all of the tracks that can be recorded), the unit will stop automatically.

#### To check the remaining time available for recording:

- ① Press the MD ■ button.
  - ② Load a MiniDisc.
  - ③ Press the DISPLAY button to find the time followed by hyphen.
- The total number of tracks previously recorded and the available remaining time will be displayed, the unit will return to the original display 4 seconds later.

#### To cancel the operation:

Before pressing the CD ► MD EDIT (HIGH or NORMAL) button, press the CD ■ button.

#### To stop recording:

Press the MD ■ button.

- Playback and recording will stop and the track numbers will be written on the MiniDisc.

#### Caution:

- When a recording is made at high speed, the playback sound will not be heard.
- Check whether recording is performed or not with the level meters.
- You cannot adjust the sound volume. "VOL HOLD" appears when you adjust the sound volume while recording at high speed.
- When a damaged CD is recorded at high speed, the unit may stop while recording, or some noise or a drop out may be recorded. In this case, record the CD at normal speed.

#### Notes:

- When the CD playing time is longer than the available MiniDisc recording time, the recording process will not start even when the CD ► MD EDIT button is pressed.

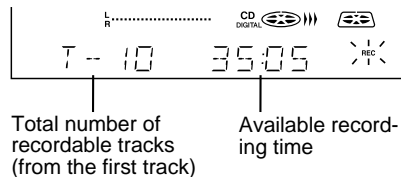

- To record as many tracks as are available, press the CD ► MD EDIT button again.

Then, when the CD ► MD EDIT button is pressed again, recording will start. However, when the MiniDisc runs out of space, "DISC FULL" will be displayed and the CD and MiniDisc will stop.

However, if the available recording time on the MiniDisc is less than the length of the first track on the CD, recording will not be performed.

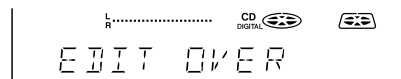

### ■ Track editing from a CD onto a MiniDisc

You can record several consecutive tracks, starting from the first track of a CD, to a MiniDisc.

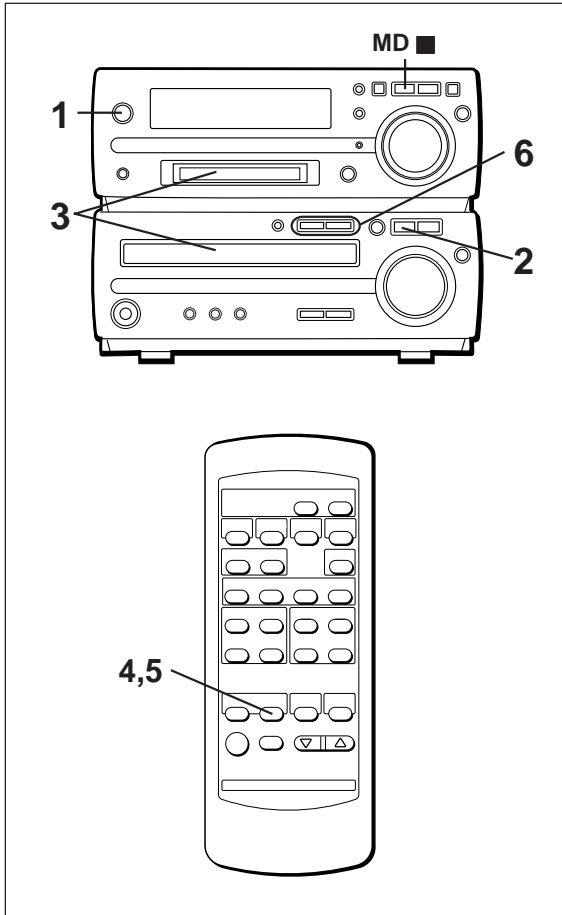

- 1 Press the ON/STAND-BY button to turn the power on.
- 2 Press the CD button.
- 3 Load a CD and a recordable MiniDisc.
- 4 Press the TRACK EDIT button.

When selecting CD

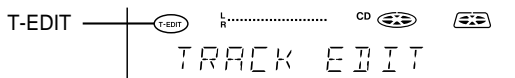

- 5 Press the TRACK EDIT button repeatedly to select the last track number you want to record.

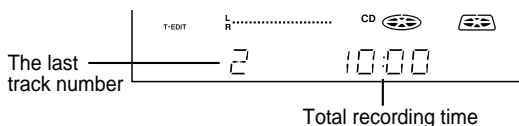

- If you select 21 tracks or more, "E. OVER" will be displayed.

- 6 Press the CD ► MD EDIT (HIGH or NORMAL) button.

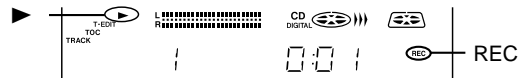

- The CD loaded will be recorded in order, starting from the first track. When a MiniDisc runs out of recording space or when a CD has been completely recorded, the CD and the MiniDisc will stop automatically.
- Recording will begin, starting from the first track of CD.
- Selected tracks will be recorded in order. After the unit has finished recording the last track, recording will stop automatically.

#### Note:

- If repeat play has been set, when you press the CD ► MD EDIT (HIGH or NORMAL) button, the repeat mode will be canceled automatically, and track editing will start.

#### To stop recording:

Press the MD button.

- Playback and recording will stop and the track numbers will be written on the MiniDisc.



■ APMS recording from a CD onto a MiniDisc

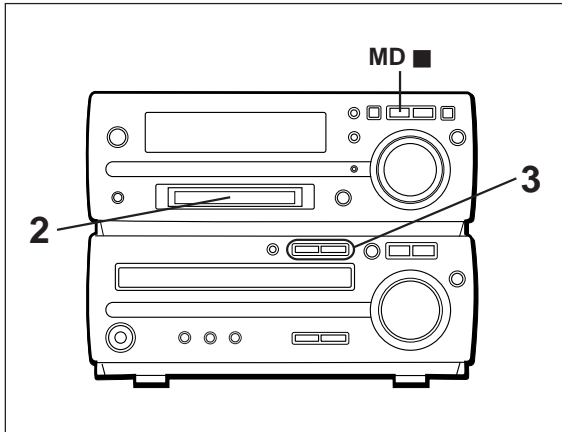

- 1 Select tracks for APMS playback (page 16).
- 2 Load a recordable MiniDisc.
- 3 Press the CD ► MD EDIT (HIGH or NORMAL) button.
  - APMS playback will start, and recording will start automatically.
  - Programmed tracks will be recorded in order. After the unit has finished recording the last track, recording will stop automatically.

Note:

- If repeat play has been set, when you press the CD ► MD EDIT (HIGH or NORMAL) button, the repeat mode will be canceled automatically, and APMS recording will start.

To stop recording:

Press the MD ■ button.

- Playback and recording will stop and the track numbers will be written on the MiniDisc.

■ To record without using One-Touch Editing

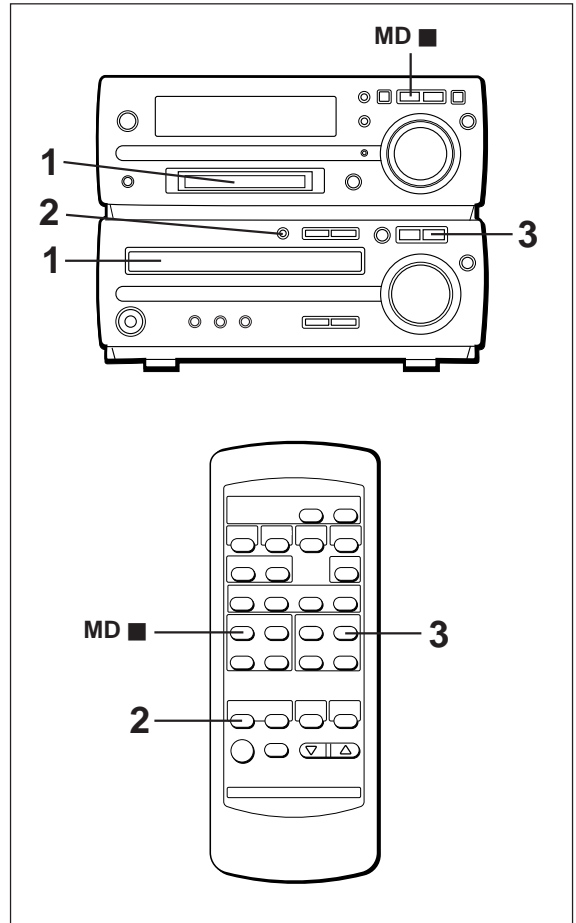

- 1 Load a CD and a recordable MiniDisc.
- 2 Press the ● REC button.
  - The unit will enter the recording stand-by mode.
- 3 Press the CD ► button.

To stop recording:

Press the MD ■ button.

- Recording will stop and the track numbers will be written on the MiniDisc.

## ■ Recording from the built-in radio onto a MiniDisc

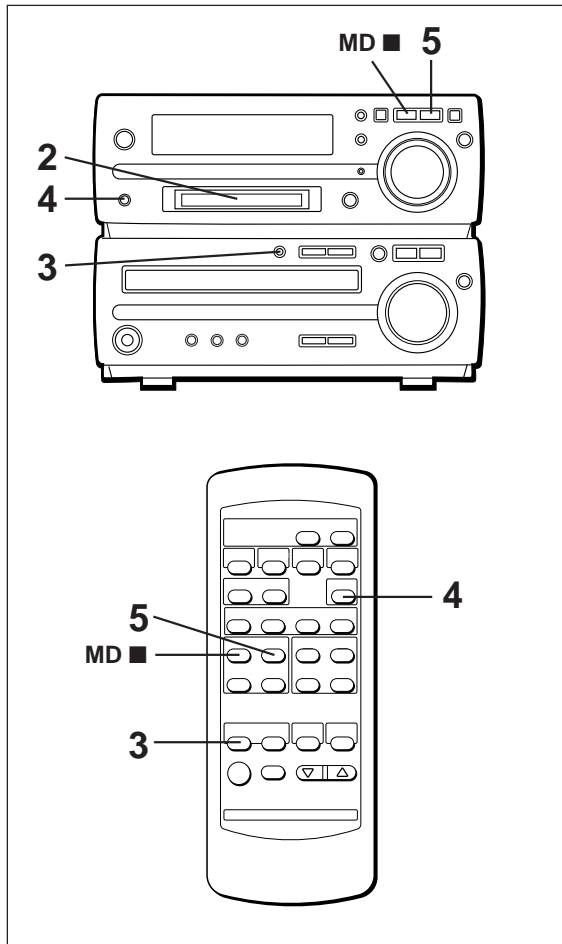

- 1 Tune in to the desired station (pages 19 - 20).
- 2 Load a recordable MiniDisc.
- 3 Press the ● REC button.
  - The unit will enter the recording stand-by mode.
- 4 Check the recordable time by pressing the DISPLAY button.

### Notes:

- Before recording an AM broadcast, enter the recording stand-by mode, and then separate the AM loop antenna from the main unit. Adjust it so that the AM broadcast can be tuned in most clearly.
- During recording, you cannot change the station.

- 5 Press the MD ►|| button.

### To stop recording:

Press the MD ■ button.

The recording will stop and the track number will be written on the MiniDisc.

### To record the track number while recording:

The recording is performed as a single track.

To identify different sections of a recording, you can increase the track number at any point during the recording process.

To create a new track number while in the recording mode, press the ● REC button.

- The track number will increase by one, and then the recording will continue.

# MINIDISC EDITING

## What the editing function can do

You can create original discs using the MiniDisc editing function, on which you can change the order of the tracks and you can create disc or track names.

- Playback-only MiniDiscs cannot be edited.
- Tracks (up to 255 tracks per disc) can be named. Since track names are displayed when the beginning of each track is located or during playback, you can quickly check the name of each track.

## To create a disc name

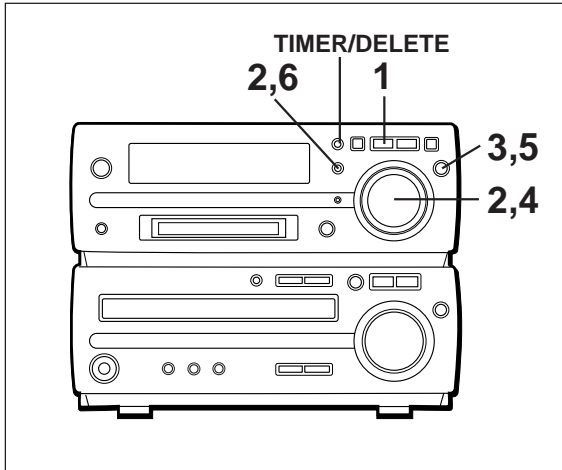

- 1 Press the MD button.
  - The total number of tracks and the total playing time on a MiniDisc will appear.
- 2 Press the NAME/TOC EDIT button, and then select "DISC NAME" using the jog dial.

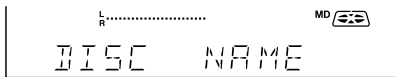

- 3 Within 10 seconds, press the MEMORY/ENTER button.

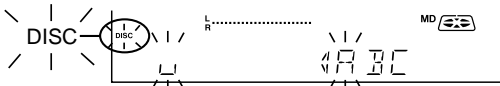

- The unit will enter the character input mode.

- 4 Select the character you want using the jog dial.

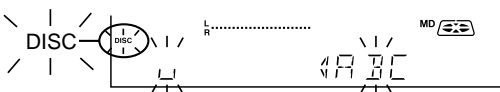

- 5 Press the MEMORY/ENTER button to enter the character.

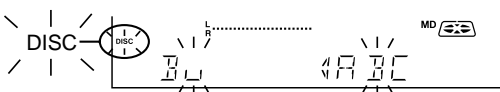

- Repeat steps 4 to 5 above to enter the characters in the name.

- 6 After entering all of the characters in the name, press the NAME/TOC EDIT button.

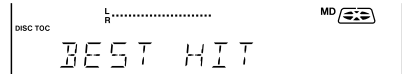

- The disc name will be recorded.

## To erase a disc name:

After performing steps 1 to 3.

- 1 Press the TIMER/DELETE button for 2 seconds or more.
  - "NAME CLEAR" will flash.
- 2 Press the MEMORY/ENTER button.

## Notes:

- Up to 40 characters can be entered.
- This function cannot be used in the random play mode and APMS play mode.

## Type of characters used

Type of characters	Characters (Symbols)
Capital letters	A B C D E F G H I J K L M N O P Q R S T U V W X Y Z
Symbols	1 2 3 4 5 6 7 8 9 0 ! " # \$ % & ' ( ) * + , - . / ? @ < = > _ `

## Number of characters you can enter

### ● Disc names and track names

Up to 40 characters (including spaces) can be entered for each name. If more than 40 characters are entered, "NAME FULL" will appear.

### ● Total number of characters per MiniDisc

A total of approximately 1,700 characters can be used for all of the disc and track names. If more than 1,700 characters are entered, "TOC FULL" will appear.

While editing, the "TOC" indicator is displayed. This means the edit results have not been recorded on the MiniDisc.

To record the results, select another input or set the unit to the stand-by mode. During writing, the "TOC" goes out, all editing changes will be recorded on the disc.

■ To create a track name

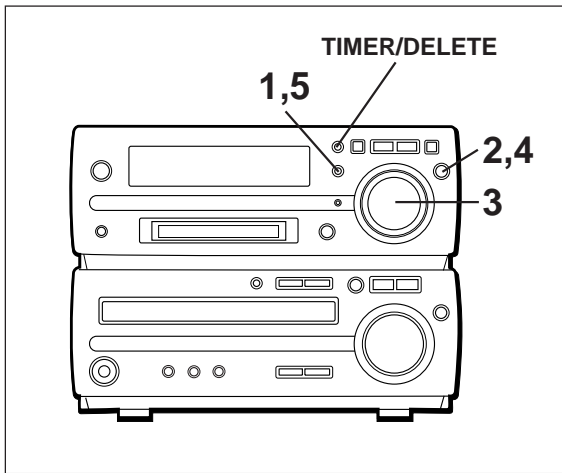

1 During playback or in the pause mode, press the NAME/TOC EDIT button.

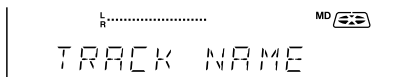

2 Within 10 seconds, press the MEMORY/ENTER button.

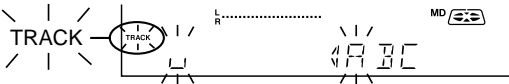

- The unit will enter the character input mode.
- The track you are listening to will be played repeatedly.

3 Select the character you want using the jog dial.

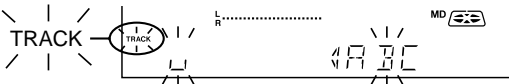

4 Press the MEMORY/ENTER button to enter the character.

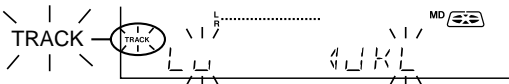

- Repeat steps 3 to 4 above to enter the characters in the name.

5 After entering all of the characters in the name, press the NAME/TOC EDIT button.

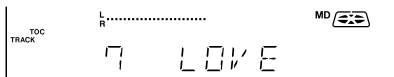

- The track name will be recorded.
- The unit will return to normal playback.

To erase a track name:

After performing steps 1 to 2.

- 1 Press the TIMER/DELETE button for 2 seconds or more.
  - "NAME CLEAR" will flash.
- 2 Press the MEMORY/ENTER button.

Notes:

- Up to 40 characters can be entered.
- This function cannot be used in the random play mode and APMS play mode.
- If you create a track name while recording the track, make sure you finish entering the name before you finish recording the track.  
If the end of the recording is reached before you have entered the complete name, only the characters entered before the recording ended will be recorded. To rename it, see page 28.

## ■ To change disc names and track names

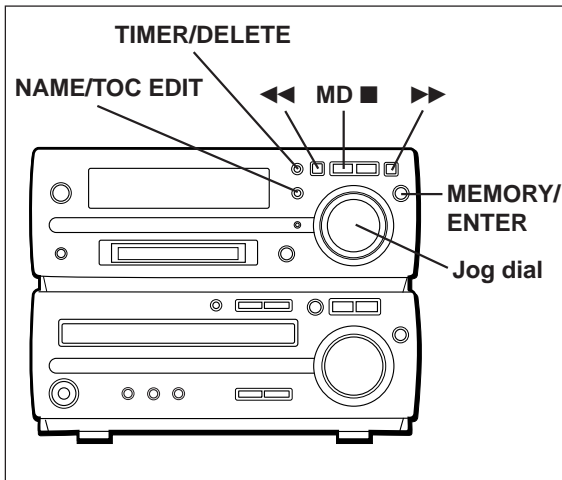

### ● To delete a character:

(Example: To change "BESUT" to "BEST")

**1** To change disc names, perform steps 1 - 3 on page 26.  
To change track names, perform steps 1 - 2 on page 27.

**2** Press the ◀ or ▶ button to flash the character to erase.

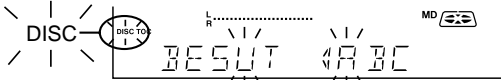

● To cancel the operation, press the MD button.

**3** Press the TIMER/DELETE button.

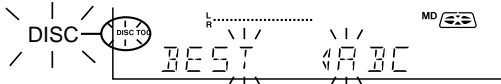

● After this step, if you are not going to enter a character, go to step 5.

**4** Select the character you want to add, using the jog dial. Then, press the MEMORY/ENTER button.

● The selected character will be added, and the original characters will move to the right by one.

**5** After entering all of the characters in the name, press the NAME/TOC EDIT button.

### ● To add a character:

(Example: To change "BET" to "BEST")

**1** To change disc names, perform steps 1 - 3 on page 26.  
To change track names, perform steps 1 - 2 on page 27.

**2** Press the ◀ or ▶ button to flash the character at the place you want to add a letter.

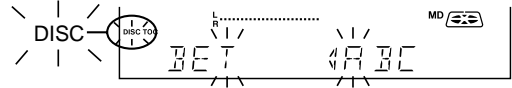

● To cancel the operation, press the MD button.

**3** Select the character you want to add, using the jog dial. Then, press the MEMORY/ENTER button.

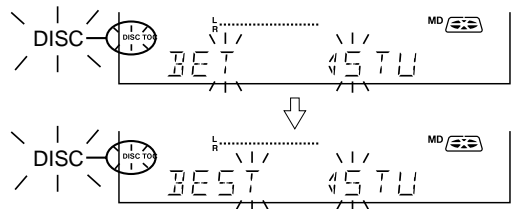

● The selected character will be added, and the original characters will move to the right by one.

**4** After entering all of the characters in the name, press the NAME/TOC EDIT button.

### Note:

● You cannot modify disc or track names created on other equipment if they are over 40 characters. In this case, erase the name and then enter a new name.

### ■ Divide

A single track can be divided into two at any desired position.

- The numbers of the tracks which come after the newly divided track will be automatically increased by one.

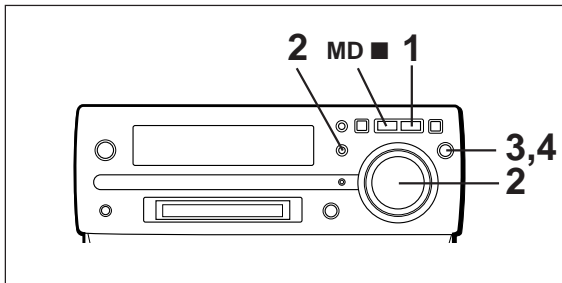
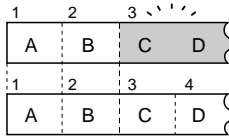

- 1 Play the track which you want to divide into two, and press the MD ► button at the point where you want to divide the track.

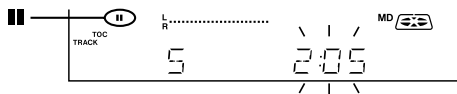

- 2 Press the NAME/TOC EDIT button, and within 10 seconds, select "DIVIDE" using the jog dial.

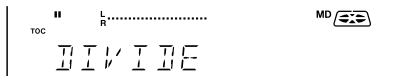

- 3 Within 10 seconds, press the MEMORY/ENTER button.

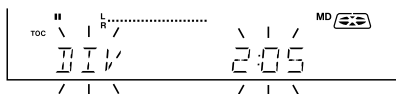

- To cancel the operation, press the MD button.

- 4 Press the MEMORY/ENTER button again.

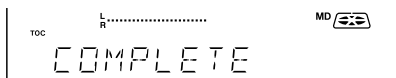

- The track is divided, and the unit is stopped at the beginning of the second of the two tracks.
- The numbers of the tracks which come after the divided track are automatically increased by one.
- When a track has been given a name is divided, the two new tracks will have the same name. If "TOC FULL" message is seen, reduce unnecessary tracks recorded on the disc to make enough space (page 37).

#### Notes:

- This unit can hold up to 255 tracks. However, even if the number of tracks assigned has not reached 255, it might not be possible to make any further divisions of tracks (page 37).
- This function cannot be used in the random play mode and APMS play mode.

### ■ Combine

Two consecutive tracks can be combined into one track.

- The numbers assigned to the tracks following the combined tracks will be decreased by one automatically.

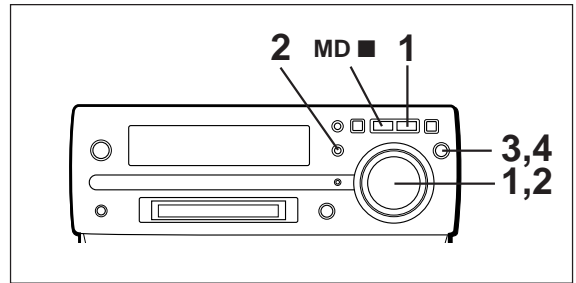
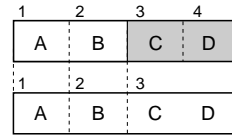

- 1 While in the stop mode, select the second of the two adjacent tracks you want to combine using the jog dial.

Or start playing the second of the two tracks you want to combine, and then press the MD ► button.

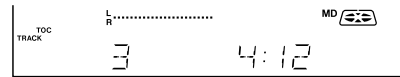

- 2 Press the NAME/TOC EDIT button, and within 10 seconds, select "COMBINE" using the jog dial.



- 3 Within 10 seconds, press the MEMORY/ENTER button.

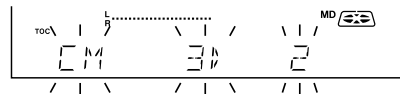

- To cancel the operation, press the MD button.

- 4 Press the MEMORY/ENTER button again.



- The two tracks are combined, and the unit is stopped at the beginning of the combined track.
- The numbers assigned to the tracks following the combined track are automatically decreased by one.

#### When both tracks have a name:

- When only the first track has a name → That name will be used.
- When only the second of the two tracks has a name → That name will be used.
- When both tracks have a name → The name of the first track will be used. To rename it, see page 28.

**To combine two non-contiguous tracks:**

(Example: the first and third tracks)

Move the third track to the second track using the MOVE function.

Then, combine the first and second tracks using the COMBINE function.

**Notes:**

- Tracks recorded from analog inputs cannot be combined with tracks recorded from CDs or MiniDiscs using the digital inputs.
- Tracks recorded in the stereo mode cannot be combined with tracks recorded in the monaural long-play mode.
- Tracks where either track's recording time is less than 15 seconds may not be combined.
- This function cannot be used in the random play mode and APMS play mode.

**■ Move**

**A designated track can be moved to any desired position.**

- The numbers assigned to the tracks following the track which is moved will be adjusted automatically.

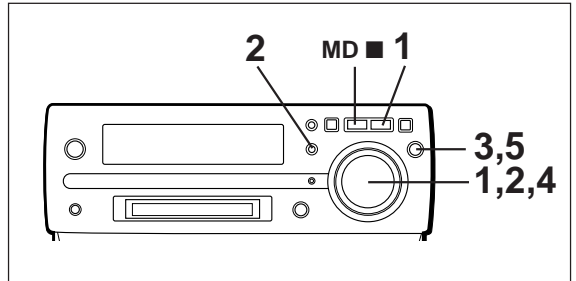
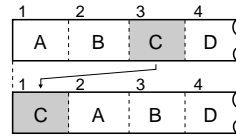

- 1** While in the stop mode, select the track you want to move using the jog dial. Or start playing the track to be moved, and then press the MD button.

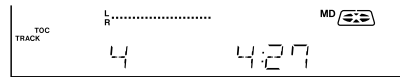

- 2** Press the NAME/TOC EDIT button, and within 10 seconds, select "MOVE" using the jog dial.

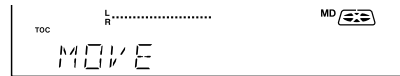

- 3** Within 10 seconds, press the MEMORY/ENTER button.

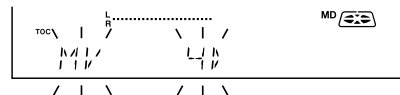

- 4** Select the new track position using the jog dial.

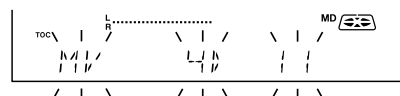

- To cancel the operation, press the MD button.

- 5** Press the MEMORY/ENTER button again.



- The track is moved, and the unit is stopped at the beginning of the new track selected in step 4.

**Notes:**

- When a track has been moved, the other tracks which are affected will be assigned new track numbers automatically.
- This function cannot be used in the random play mode and APMS play mode.

### ■ Erase

Tracks you want to erase can be erased one at a time.

- Once a track has been erased, it cannot be recovered. Double-check the track number before erasing it.

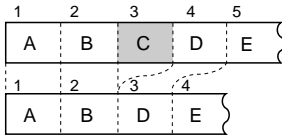

To erase tracks one at a time:

- 1 While in the stop mode, select the track you want to erase using the jog dial. Or start playing the track to be erased, and then press the MD button.

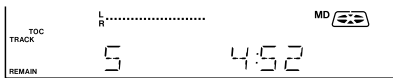

- 2 Press the NAME/TOC EDIT button, and within 10 seconds, select "ERASE" using the jog dial.

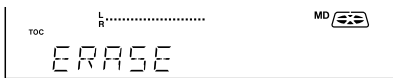

- 3 Within 10 seconds, press the MEMORY/ENTER button.

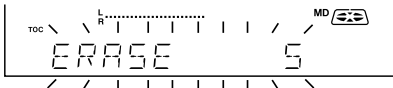

- To cancel the operation, press the MD button.

- 4 Press the MEMORY/ENTER button again.

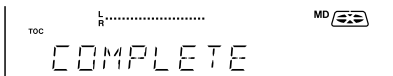

- The track is erased, and the unit is stopped at the beginning of the next track.

#### Notes:

- When a track is erased, the numbers assigned to the tracks following the erased track will be automatically decreased by one.
- When a track is erased, the track name will be erased at the same time.
- This function cannot be used in the random play mode and APMS play mode.

### ■ All Erase

All of the tracks you want to erase can be erased at once.

- Once all of tracks have been erased, they cannot be recovered. Double-check the tracks before erasing them.

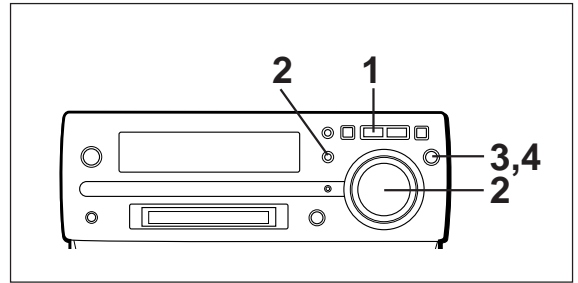
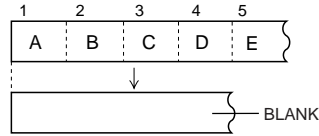

To erase all of the tracks at once:

- 1 Press the MD button.
  - The total number of tracks and the total playing time on a MiniDisc will appear.
- 2 Press the NAME/TOC EDIT button, and within 10 seconds, select "ALL ERASE" using the jog dial.

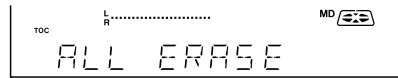

- 3 Within 10 seconds, press the MEMORY/ENTER button.

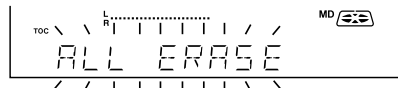

- To cancel the operation, press the MD button.

- 4 Press the MEMORY/ENTER button again.

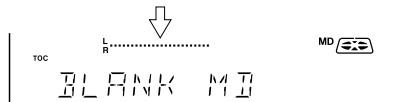
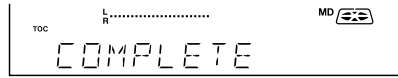

- All of the track numbers and track names will be erased.

#### Note:

- This function cannot be used in the random play mode and APMS play mode.



## TIMER OPERATION

- Before setting the timer, make sure that the clock setting is correct (page 11).

### ■ Timer playback/Timer recording

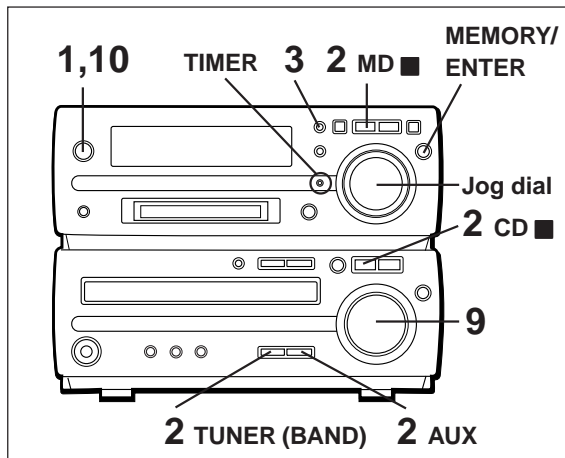

Before timer operation, the following preparations are required.

- Load a CD and a recordable MiniDisc for timer recording or
- Preset the radio station that you want to record from or listen to during timer playback.

**1** Press the ON/STAND-BY button to turn the power on.

**2** (To select timer playback source)

Press the CD ■, MD ■, TUNER (BAND) or AUX button.

(To select timer recording source)

Press the CD ■, TUNER (BAND) or AUX button.

**3** (To select timer playback)

Press the TIMER/DELETE button to select the timer playback mode.



(To select timer recording)

Press the TIMER/DELETE button again to select the timer recording mode.



**4** While "Ⓞ PLAY" or "Ⓞ REC" is flashing, press the MEMORY/ENTER button.

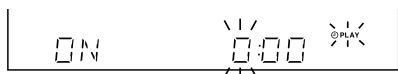

**5** Turn the jog dial to set the hour to start, and then press the MEMORY/ENTER button.

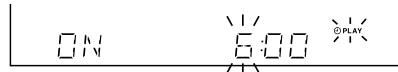

**6** Turn the jog dial to set the minute to start, and then press the MEMORY/ENTER button.

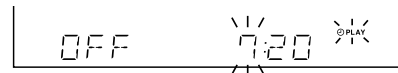

- If the ending time is not set manually, it will automatically be set for one hour after the starting time.

**7** Turn the jog dial to set the hour to stop, then press the MEMORY/ENTER button.

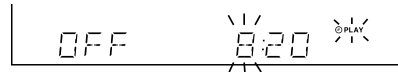

**8** Turn the jog dial to set the minute to stop, then press the MEMORY/ENTER button.

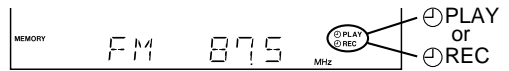

**9** Adjust the VOLUME control for the desired volume.

- Be careful not to turn the volume up too high.

**10** Press the ON/STAND-BY button to enter the stand-by mode.

- The TIMER indicator will light up.

**11** When the timer start time is reached, timer playback or timer recording will start.

**12** When the timer end time is reached, timer recording will stop.

#### Notes:

- The timer cannot control the component connected to the auxiliary input jacks.
- When the CD or MiniDisc is played to the end, playback will stop before the stop time. If you wish to play to the stop time, set repeat play for the CD or MiniDisc.
- Timer playback and timer recording cannot be set at the same time using the timer.

## (Continued)

### To confirm the timer setting:

Press the TIMER/DELETE button once.

- The turn-on time, the turn-off time will be displayed.

### To cancel timer operation:

- ① While in the timer stand-by mode, press the ON/STAND-BY button to turn the power on.
- ② Press the TIMER/DELETE button repeatedly to turn off the timer, "⏪ PLAY" or "⏩ REC" will go out.

### Caution:

In the following cases, the timer recording function will not work.

- When a MiniDisc has not been inserted.
- When a playback-only MiniDisc is inserted.
- When the MiniDisc you inserted is protected against accidental erasure.
- When there is no recording space left on the MiniDisc you have inserted (when the "TOC FULL" or "DISC FULL" message appears).

## ■ Sleep operation

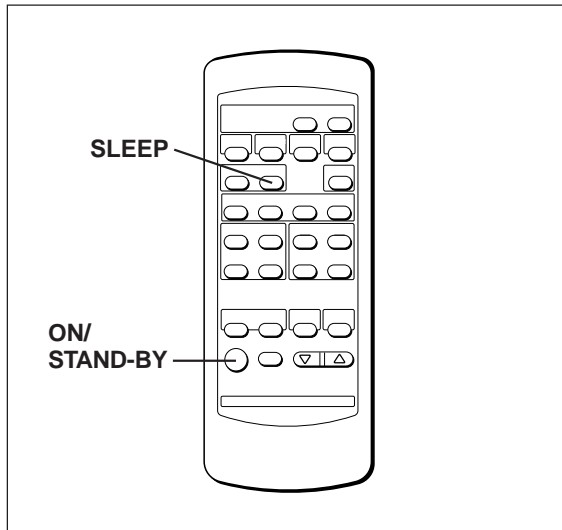

The radio, CD and MiniDisc can all be turned off automatically.

### 1 Play the desired sound source.

### 2 Press the SLEEP button.



- If you do not need to change the time, the unit will enter the sleep mode automatically.

### 3 Press the SLEEP button to select the time.

(Maximum: 2 hours - Minimum: 30 minutes)

The amount of sleep time can also be changed during the sleep operation.

- 2 hours-30 minutes → 30-minute intervals

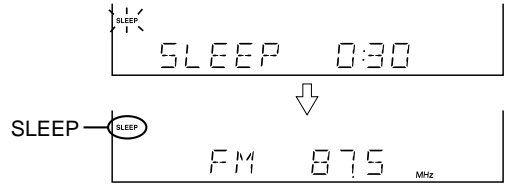

### 4 The unit will enter the stand-by mode automatically after the preset sleep time has elapsed.

### To cancel the sleep operation:

Press the SLEEP button repeatedly. "0:00" will appear and "SLEEP" will go out at the same time.

- The sleep operation will be canceled.

### To confirm the remaining sleep time:

Press the SLEEP button.

### Notes:

- Once the sleep time is set, it will remain the same duration until the setting is changed.
- The sleep functions of this unit cannot be used to control equipment connected to this unit. You must use the sleep functions of the other equipment, if it has them.

## ■ Simultaneous sleep and timer operation

- ① Perform steps 1 - 9 on page 42, "Timer playback/Timer recording".
- ② Perform steps 1 - 3 of the "Sleep operation" on this page.

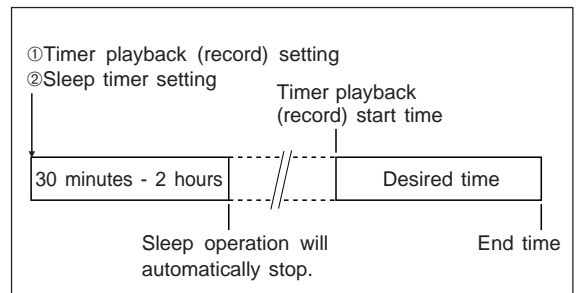

## USING EXTERNAL UNITS

### ■ Connecting external units

Before connecting external units, set this unit to the stand-by mode and turn off the power to the external units.

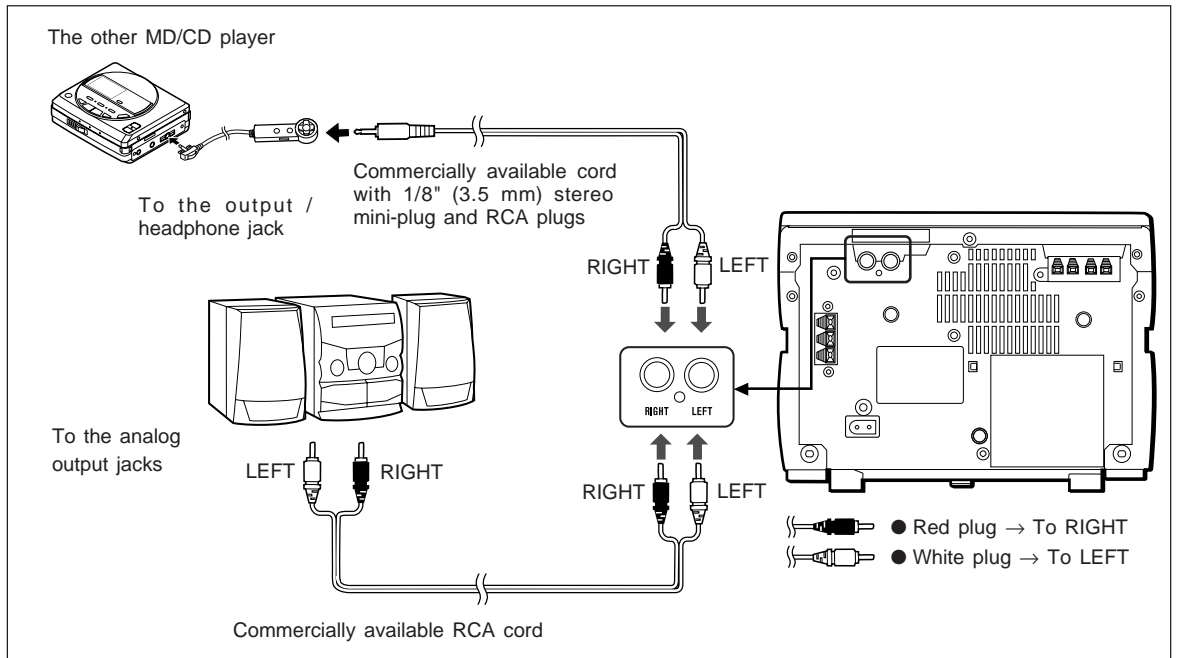

### ■ Headphones

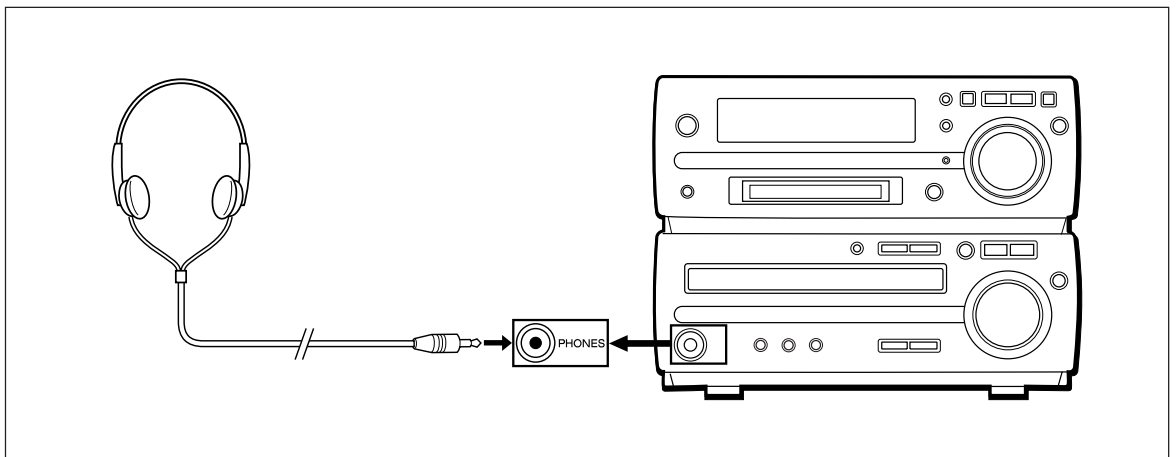

#### Notes:

- Before plugging in or unplugging the headphones, make sure the volume level is reduced.
- Be sure your headphones have a 1/8" (3.5 mm) diameter plug and are between 16 ohms and 50 ohms impedance. The recommended impedance is 32 ohms.
- When headphones are connected, the speakers are disabled automatically. Adjust the VOLUME control for the desired headphone volume.

### ■ Listening to sound from an external unit

To listen to sound from an external unit connected to the AUX input terminals:

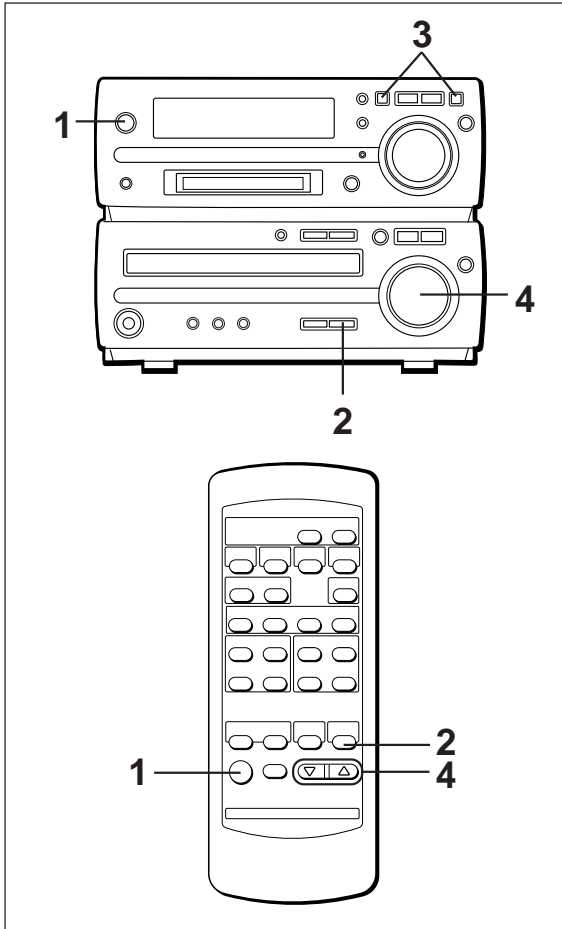

- 1 Press the ON/STAND-BY button to turn the power on.
- 2 Press the AUX button.
- 3 Start playback on the external unit, and adjust the input sound level using the ◀◀ or ▶▶ button.
  - Adjust the recording level so that the "OVER" indicator does not light at the maximum level.

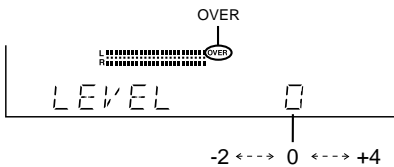

- 4 Adjust the listening level using the VOLUME buttons on the remote control or the VOLUME control on the main unit.

### ■ Manual recording

You can start a recording manually while listening to playback from other external equipment (tape deck, tuner) connected to the auxiliary input.

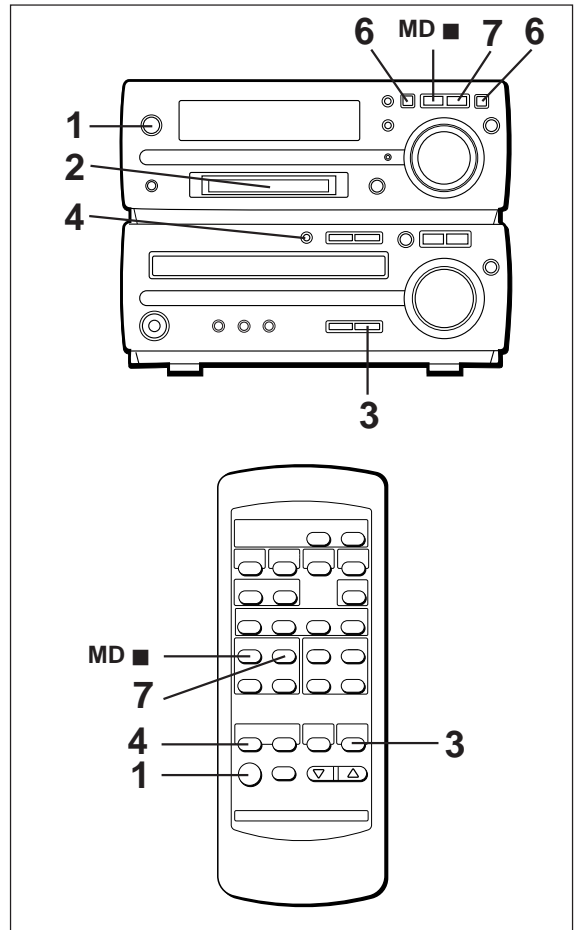

- 1 Press the ON/STAND-BY button to turn the power on.
- 2 Load a recordable MiniDisc.
- 3 Press the AUX button.
- 4 Press the ● REC button.
- 5 Start playback on the external unit.
- 6 Adjust the recording level using the ◀◀ or ▶▶ button.
  - Adjust the recording level so that the "OVER" indicator does not light at the maximum level.

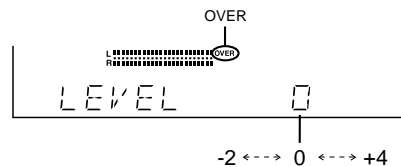

- 7 Press the MD ▶■ button.

**To stop recording:**  
Press the MD ■ button.

## WHAT IS A MINIDISC?

The disc is stored in a cartridge. You can handle it easily without worrying about dust, fingerprints, etc. However, dust entering the opening of the cartridge, dirt on the cartridge, warping, etc. may cause malfunctions. Please note the following.

### ■ Handling the MiniDisc

#### Do not touch the disc directly!

Do not open the shutter or touch the disc directly. If the shutter is opened forcibly, it may break.

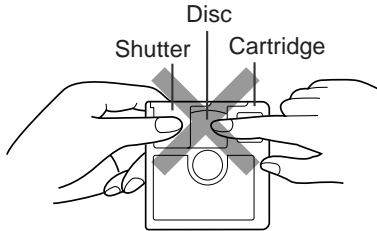

#### Where not to store discs:

Do not store discs in places with high temperatures or humidity. Specifically, do not leave discs in places exposed to direct sunlight or in cars with doors and windows closed. Do not leave discs in places where sand can get into the cartridge easily (e.g. beaches).

### ■ To prevent recorded discs from being erased accidentally

Slide the accidental erase prevention tab, located on the side of the disc, in the direction indicated by the arrow.

- The disc will then be protected against accidental erasure.
- To add a recording to such a disc, slide the accidental erase prevention tab back to its original position.

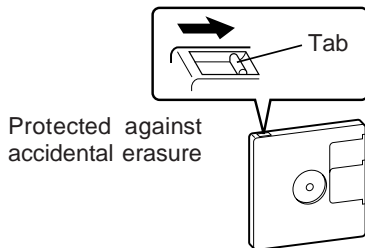

### ■ What is a MiniDisc?

- A MiniDisc is a 2-1/2" (64 mm) diameter disc which is stored in a cartridge. MiniDiscs are easy to handle, compared to CDs, because they are protected against dust and scratches.
- Recording and playback use a digital system with a sound quality that is similar to that found on CDs. MiniDiscs cannot twist or stretch like tapes. The quality of sound will not deteriorate. MiniDiscs are extremely durable.
- Never disassemble MiniDiscs.

### ■ Adaptive TRansform Acoustic Coding

#### [ATRAC]

The ATRAC (Adaptive TRansform Acoustic Coding) is a new technology that is designed to eliminate the information in sounds which you can not hear and to compress the remaining sound data so that the recording uses about 1/5 of the original sound information. Sound data is analyzed and filtered to take advantage of psycho acoustic masking. The acoustic quality of the sound is not impaired.

### ■ Types of discs

There are two types of discs: playback-only and recordable types.

#### ● Playback-only MiniDisc:

This type of MiniDisc is used for commercially available prerecorded music. This is the same kind of optical disc as CDs. Playback is performed using an optical pickup. (Recording and editing are not possible.)

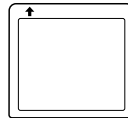

A Shutter will be used on only one side (back).

#### ● Recordable MiniDisc:

This is a "raw disc" on which recording can be performed. A magneto optical disc is used. Recordings are made using a laser and magnetic field. Repeated recording is possible.

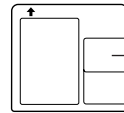

Shutters will be used on both sides.

### ■ How to apply labels

When sticking a label on a MiniDisc cartridge, be sure to observe the following. If a label is not affixed properly, a MiniDisc may become jammed in the unit such that it can not be removed.

- Stick a label correctly to the specified area. (Do not stick labels to areas other than the specified one.)
- Do not stick one label upon another.
- If a label is peeling off or starts to come loose, replace it with a new one.

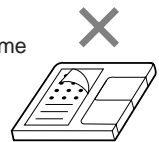

### ■ Shock Resistant Memory

During playback, approximately 10 seconds of information is stored in the semiconductor memory. Therefore, even when the pickup cannot read information for a second or two due to an external shock, the sound continues without interruption because the information stored in memory is output.

## MINIDISC SYSTEM LIMITATIONS

Even if the maximum recording time of a MiniDisc has not been reached, "TOC FULL" may be displayed.	In the MD system, the delimiter of the recording area on a MiniDisc is programmed in a TOC. If partial erasing, recording and editing are repeated several times, TOC information will fill up, even though the number of tracks has not reached the limit (255 tracks), and further recording will be impossible. (If you use the all erase function, this MiniDisc can be used from the beginning.)
Even if the maximum recording time of a MiniDisc has not been reached, "DISC FULL" may be displayed.	If there is any flaw on the MiniDisc, that part is automatically excluded from the space available for recording. Therefore, the recording time becomes shorter.
Even if several short tracks are erased, the remaining recording time may not show an increase.	When the remaining recording time of a disc is displayed, short tracks less than 12 seconds long may not be included in the total.
Two tracks may not be combined in editing.	For MiniDiscs on which repeated recording and editing operations were performed, the COMBINE function may not work. A track recorded from a CD (digital recording) and a track recorded from a radio or other equipment (analog recording) cannot be combined.
The total of the recorded time and time remaining on a disc may not add up to the maximum possible recording time.	A cluster (about 2 seconds) is normally the minimum unit of recording. So, even if a track is less than 2 seconds long, it will use about 2 seconds of space on the disc. Therefore, the time actually available for recording may be less than the remaining time displayed. If there are scratches on discs, those sections will be automatically avoided (no recording will be placed in those sections). Therefore, the recording time will be reduced.
If recorded tracks are fast reversed or fast forwarded, the sound may skip.	A MiniDisc which has been recorded or edited repeatedly may skip during fast reverse or fast forward.

## TROUBLESHOOTING

### ■ If a problem occurs

If this unit functions abnormally during operation, first check the following items. If the unit continues to function abnormally, or if an abnormality appears other than listed below, set this unit to the stand-by mode and disconnect the AC power plug, then consult your SHARP dealer or service personnel.

#### General

Symptom	Possible cause	Remedy
● The clock is wrong.	● Did a power failure occur?	● Try setting it again.
● When a button is pressed, the unit does not respond.	_____	● Set this unit to the stand-by mode and then turn it back on. Then, retry the operation.
● No sound is heard.	● Is the volume level is set to "0"? ● Are the headphones connected? ● Are the speaker wires disconnected?	● Increase the volume level. ● Disconnect the headphones. ● Connect the wires securely.
● Radios make unusual noise or the picture on the TV screen is distorted.	● When a radio or TV which uses an indoor antenna is placed near the unit, the picture on the TV screen may be distorted or the radio may not function properly.	● It is recommended that you use an external antenna.

#### CD Playback

Symptom	Possible cause	Remedy
● Even though a disc has been loaded, "NO DISC" is displayed. ● Playback stops in the middle of a track, or playback is not performed properly. ● Playback sounds are skipped.	● The disc is loaded up-side down. ● The disc is very dirty. ● The disc does not satisfy the standards. ● Is the unit located near excessive vibrations? ● Has condensation formed inside the unit?	● Load the disc with the correct side up. ● Clean the disc. ● Load the correct disc. ● Place the unit on a firm, level surface free from vibration. ● Remove the disc and leave the power turned on. The unit should function properly in about 1 hour.

## (Continued)

### MiniDisc recording and playback

Symptom	Possible cause	Remedy
<ul style="list-style-type: none"> <li>● A recording cannot be made.</li> </ul>	<ul style="list-style-type: none"> <li>● Is the MiniDisc protected against accidental erasure?</li> <li>● Did you try to make recording on a playback-only MiniDisc?</li> <li>● Can you see the "DISC FULL" or "TOC FULL" message in the display?</li> </ul>	<ul style="list-style-type: none"> <li>● Slide the accidental erase prevention tab back to its original position.</li> <li>● Replace it with a recordable disc.</li> <li>● Put in another recordable disc with recording space on it.</li> </ul>
<ul style="list-style-type: none"> <li>● Even though a disc has been loaded, "NO DISC" or "CAN'T READ" is displayed.</li> <li>● Playback sounds are skipped.</li> </ul>	<ul style="list-style-type: none"> <li>● The disc is very dirty.</li> <li>● Is the unit located near excessive vibrations?</li> <li>● Has condensation formed inside the unit?</li> </ul>	<ul style="list-style-type: none"> <li>● Clean the disc.</li> <li>● Place the unit on a firm, level surface free from vibration.</li> <li>● Remove the disc and leave the power turned on. The unit should function properly in about 1 hour.</li> </ul>

### Radio reception

Symptom	Possible cause	Remedy
<ul style="list-style-type: none"> <li>● Radios make unusual noise consecutively.</li> </ul>	<ul style="list-style-type: none"> <li>● The unit is placed near the TV or computer.</li> <li>● The antenna direction is not placed properly.</li> </ul>	<ul style="list-style-type: none"> <li>● When the unit receives a radio broadcast near a TV set, a computer or a word-processor, it may pick up noise. If this happens, move the unit from the place where the noise is picked up.</li> <li>● Correct the antenna direction.</li> </ul>
<ul style="list-style-type: none"> <li>● The preset channel cannot be recalled.</li> </ul>	<ul style="list-style-type: none"> <li>● Did you erase the programmed station?</li> </ul>	<ul style="list-style-type: none"> <li>● Preset the channel again.</li> <li>● Redo programming.</li> </ul>

### Remote control

Symptom	Possible cause	Remedy
<ul style="list-style-type: none"> <li>● The remote control does not function or does not operate properly.</li> </ul>	<ul style="list-style-type: none"> <li>● The batteries (polarity) are not inserted properly.</li> <li>● The batteries inside the remote control are dead.</li> <li>● The remote control is operated from an incorrect distance or angle.</li> </ul>	<ul style="list-style-type: none"> <li>● Insert properly.</li> <li>● Replace the batteries.</li> <li>● Operate it within a range of 8" (0.2 m) to 20' (6 m) and within an angle of 15 ° to either side of center.</li> </ul>
<ul style="list-style-type: none"> <li>● The power cannot be turned on from the remote control.</li> </ul>	<ul style="list-style-type: none"> <li>● Is the AC power cord plugged in?</li> </ul>	<ul style="list-style-type: none"> <li>● Connect the AC power cord.</li> </ul>

## RESETTING THE MICROCOMPUTER

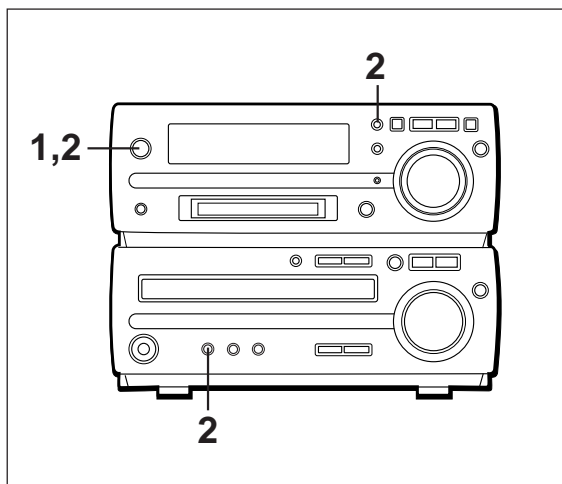

If this product is subjected to strong external interference (mechanical shock, excessive static electricity, abnormal supply voltage due to lightning, etc.) or if it is operated incorrectly, it may malfunction or the display may not function correctly. If such a problem occurs, do the following:

- 1 Press the ON/STANDBY button to enter the stand-by mode.
- 2 Press the ON/STANDBY button while holding down the SURROUND button and the TIMER/DELETE button.
  - "ALL CLEAR" will appear.

#### Caution:

- The operation explained above will erase all data stored in memory including clock and timer settings, and tuner, MiniDisc and CD presets.

## ERROR MESSAGES

When an error message is displayed, proceed as follows:

Error messages	Meaning	Remedy
<b>BLANK MD</b>	<ul style="list-style-type: none"> <li>● Nothing is recorded. (Neither music nor disc name is recorded.)</li> </ul>	<ul style="list-style-type: none"> <li>● For playback, replace it with a recorded MiniDisc.</li> </ul>
<b>CAN'T COPY</b>	<ul style="list-style-type: none"> <li>● You tried to record from a copy prohibited CD.</li> </ul>	<ul style="list-style-type: none"> <li>● Replace the CD.</li> </ul>
<b>CAN'T READ * ( * :Number or symbol)</b>	<ul style="list-style-type: none"> <li>● The disc is damaged.</li> <li>● TOC information cannot be read.</li> <li>● MiniDisc not specified.</li> </ul>	<ul style="list-style-type: none"> <li>● Replace it with another disc.</li> <li>● Erase the disc and try recording again.</li> </ul>
<b>CAN'T EDIT</b>	<ul style="list-style-type: none"> <li>● A track cannot be edited.</li> </ul>	<ul style="list-style-type: none"> <li>● Change the stop position of the track and then try editing it.</li> </ul>
<b>CAN'T REC</b>	<ul style="list-style-type: none"> <li>● Recording cannot be performed correctly due to vibration or shock in the unit.</li> </ul>	<ul style="list-style-type: none"> <li>● Re-record or replace the MiniDisc.</li> </ul>
<b>CAN'T WRITE</b>	<ul style="list-style-type: none"> <li>● The TOC information could not be created properly due to a mechanical shock or to scratches on the disc.</li> </ul>	<ul style="list-style-type: none"> <li>● Set this unit to the stand-by mode and try to write the TOC again. (Remove any source of shock or vibration while writing.)</li> </ul>
<b>DISC FULL</b>	<ul style="list-style-type: none"> <li>● The disc is out of recording space.</li> </ul>	<ul style="list-style-type: none"> <li>● Replace the disc with another recordable disc, or erase some of the tracks on the disc to free up recording space.</li> </ul>
<b>E-CD 20</b>	<ul style="list-style-type: none"> <li>● The CD tray is not working properly.</li> </ul>	<ul style="list-style-type: none"> <li>● Set this unit to the stand-by mode and turn the power on again.</li> </ul>
<b>E. OVER</b>	<ul style="list-style-type: none"> <li>● You chose 21 or more tracks for track editing.</li> </ul>	<ul style="list-style-type: none"> <li>● Decrease the number of tracks.</li> </ul>
<b>EDIT OVER</b>	<ul style="list-style-type: none"> <li>● There is no space to make CD editing on the disc.</li> </ul>	<ul style="list-style-type: none"> <li>● Replace it with a disc that has enough time to record.</li> </ul>
<b>Er-MD * * ( * :Number or symbol)</b>	<ul style="list-style-type: none"> <li>● A MiniDisc is not working properly.</li> </ul>	<ul style="list-style-type: none"> <li>● Set this unit to the stand-by mode and turn the power on again.</li> </ul>
<b>NAME FULL</b>	<ul style="list-style-type: none"> <li>● The number of characters for the disc name or track name exceeds 40.</li> </ul>	<ul style="list-style-type: none"> <li>● Shorten the disc or track name.</li> </ul>
<b>NO DISC</b>	<ul style="list-style-type: none"> <li>● A MiniDisc has not been loaded.</li> <li>● The MiniDisc data cannot be read.</li> <li>● A CD has not been loaded.</li> <li>● The CD data cannot be read.</li> </ul>	<ul style="list-style-type: none"> <li>● Load a MiniDisc.</li> <li>● Reload the MiniDisc.</li> <li>● Load a CD.</li> <li>● Reload the CD.</li> </ul>
<b>NOT AUDIO</b>	<ul style="list-style-type: none"> <li>● The data recorded on this disc is not audio data.</li> </ul>	<ul style="list-style-type: none"> <li>● Select another track.</li> <li>● Replace the disc.</li> </ul>
<b>PLAY MD</b>	<ul style="list-style-type: none"> <li>● You tried to record on a playback-only disc.</li> </ul>	<ul style="list-style-type: none"> <li>● Replace it with another recordable disc.</li> </ul>
<b>PROTECTED</b>	<ul style="list-style-type: none"> <li>● The disc is write protected.</li> </ul>	<ul style="list-style-type: none"> <li>● Move the write protection tab back to its original position.</li> </ul>
<b>TEMP OVER</b>	<ul style="list-style-type: none"> <li>● The temperature is too high.</li> </ul>	<ul style="list-style-type: none"> <li>● Set this unit to the stand-by mode and wait for a while.</li> </ul>
<b>TOC FORM * * ( * :Number or symbol)</b>	<ul style="list-style-type: none"> <li>● TOC information recorded on the MD does not match the MiniDisc specifications or it cannot be read.</li> </ul>	<ul style="list-style-type: none"> <li>● Replace it with another disc.</li> <li>● Erase the disc and try recording again.</li> </ul>
<b>TOC FULL</b>	<ul style="list-style-type: none"> <li>● There is no space left for recording track numbers.</li> </ul>	<ul style="list-style-type: none"> <li>● Replace it with another recordable disc.</li> </ul>
<b>TOC FULL 1</b>	<ul style="list-style-type: none"> <li>● There is no space left for recording character information.</li> </ul>	<ul style="list-style-type: none"> <li>● Replace it with another recordable disc.</li> <li>● Erase the needless characters.</li> </ul>
<b>? DISC</b>	<ul style="list-style-type: none"> <li>● The data contains an error.</li> <li>● MiniDisc not specified.</li> </ul>	<ul style="list-style-type: none"> <li>● Replace it with another disc.</li> </ul>



## MAINTENANCE

### External care

- Periodically wipe the cabinet with a soft cloth and a diluted soap solution, then wipe with a dirty cloth.
- Do not use chemically treated cleaning cloths or other chemicals.

### Internal care

- In order to ensure proper operation of the CD player, preventative maintenance (cleaning of the laser pick-up lens) should be performed periodically in order to keep the lens dust-free. Lens cleaners are commercially available. Contact your local CD software dealer for options.

## SPECIFICATIONS

As part of our policy of continuous improvement, SHARP reserves the right to make design and specification changes for product improvement without prior notice. The performance specification figures indicated are nominal values of production units. There may be some deviations from these values in individual units.

### General

**Power source:** AC 120 V, 60 Hz

**Power consumption:** 51W

**Dimensions:** Width; 8-1/2" (215 mm)  
Height; 6-7/16" (162 mm)  
Depth; 13-1/2" (342 mm)

**Weight:** 9.7 lbs. (4.4 kg)

### Amplifier section

**Output power:** FTC 12 watts per channel minimum RMS into 6 ohms from 60 Hz to 20 kHz with no more than 10 % total harmonic distortion

**Output terminals:** Speaker; 6 ohms  
Headphones; 16 - 50 ohms (recommended 32 ohms)

**Input terminals:** Auxiliary; 500 mV/47 k ohms

### MiniDisc recorder section

**Type:** MiniDisc recorder

**Signal readout:** Non-contact, 3-beam semiconductor laser pickup

**Rotation speed:** 400 - 900 rpm CLV, Approx.

**Error correction:** ACIRC (Advanced Cross Interleave Reed-Solomon Code)

**Quantization:** 20-bit linear (A/D converter)

**Coding:** ATRAC (Adaptive Transform Acoustic Coding)

**Sampling frequency:** 44.1 kHz

**Recording method:** Magnetic modulation overwrite method

**Frequency response:** 20 - 20,000 Hz

**D/A converter:** 1-bit D/A converter

**Wow and flutter:** Unmeasurable (less than 0.001% W. peak)

**Signal/noise ratio:** 95 dB (1 kHz)

**Dynamic range:** 90 dB (1 kHz)

**Audio channel:** Stereo; 2 channels  
Monaural; 1 channel (playback only)  
(long-time recording mode)

### Compact disc player section

**Type:** Drawer type compact disc player

**Signal readout:** Non-contact, 3-beam semiconductor laser pickup

**Rotation speed:** 200 - 500 rpm CLV, Approx.

**Error correction:** CIRC (Cross Interleave Reed-Solomon Code)

**Quantization:** 16-bit linear

**Frequency response:** 20 - 20,000 Hz

**D/A converter:** 1-bit D/A converter

**Signal/noise ratio:** 95 dB (1 kHz)

**Dynamic range:** 90 dB (1 kHz)

**Wow and flutter:** Unmeasurable (less than 0.001% W. peak)

### Tuner section

**Frequency range:** FM; 87.5 - 108.0 MHz  
AM; 530 - 1,720 kHz

**Sensitivity:** FM; 2.5  $\mu$ V (75 ohms unbalanced)  
AM; 650  $\mu$ V/m

### Speaker section

**Type:** 2-way speaker system  
[4" (10 cm) woofer and 2" (5 cm) tweeter]

**Maximum input power:** 30 W

**Rated input power:** 15 W

**Impedance:** 6 ohms

**Dimensions:** Width; 6-5/16" (160 mm)  
Height; 11-1/16" (280 mm)  
Depth; 7-5/16" (185.5 mm)

**Weight:** 4.4 lbs. (2 kg)/each

**MEMO**

**MEMO**

## CONSUMER LIMITED WARRANTY

SHARP ELECTRONICS CORPORATION warrants to the first consumer purchaser that this Sharp brand product (the "Product"), when shipped in its original container, will be free from defective workmanship and materials, and agrees that it will, at its option, either repair the defect or replace the defective Product or part thereof with a new or remanufactured equivalent at no charge to the purchaser for parts or labor for the period(s) set forth below.

This warranty does not apply to any appearance items of the Product nor to the additional excluded item(s) set forth below nor to any Product the exterior of which has been damaged or defaced, which has been subjected to improper voltage or other misuse, abnormal service or handling, or which has been altered or modified in design or construction.

In order to enforce the rights under this limited warranty, the purchaser should follow the steps set forth below and provide proof of purchase to the servicer.

The limited warranty described herein is in addition to whatever implied warranties may be granted to purchasers by law. ALL IMPLIED WARRANTIES INCLUDING THE WARRANTIES OF MERCHANTABILITY AND FITNESS FOR USE ARE LIMITED TO THE PERIOD(S) FROM THE DATE OF PURCHASE SET FORTH BELOW. Some states do not allow limitations on how long an implied warranty lasts, so the above limitation may not apply to you.

Neither the sales personnel of the seller nor any other person is authorized to make any warranties other than those described herein, or to extend the duration of any warranties beyond the time period described herein on behalf of Sharp.

The warranties described herein shall be the sole and exclusive warranties granted by Sharp and shall be the sole and exclusive remedy available to the purchaser. Correction of defects, in the manner and for the period of time described herein, shall constitute complete fulfillment of all liabilities and responsibilities of Sharp to the purchaser with respect to the Product, and shall constitute full satisfaction of all claims, whether based on contract, negligence, strict liability or otherwise. In no event shall Sharp be liable, or in any way responsible, for any damages or defects in the Product which were caused by repairs or attempted repairs performed by anyone other than an authorized servicer. Nor shall Sharp be liable or in any way responsible for any incidental or consequential economic or property damage. Some states do not allow the exclusion of incidental or consequential damages, so the above exclusion may not apply to you.

THIS WARRANTY GIVES YOU SPECIFIC LEGAL RIGHTS. YOU MAY ALSO HAVE OTHER RIGHTS WHICH VARY FROM STATE TO STATE.

### Model Specific Section

**Your Product Model Number & Description:**

MD-MX20 MD Compact Component System

(Be sure to have this information available when you need service for your Product.)

One (1) year parts and labor from the date of purchase.

**Warranty Period for this Product:**

**Additional Item(s) Excluded from**

**Warranty Coverage (if any):**

**Where to Obtain Service:**

Non-functional accessories, supplies, and consumable items. At a Sharp Authorized Servicer located in the United States.

To find a location of the nearest Sharp Authorized Servicer, call Sharp toll free at 1-800-BE-SHARP.

Ship prepaid or carry in your Product to a Sharp Authorized Servicer.

Be sure to have **Proof of Purchase** available. If you ship the Product, be sure it is insured and packaged securely.

**What to do to Obtain Service:**

TO OBTAIN SUPPLY, ACCESSORY OR PRODUCT INFORMATION,  
CALL **1-800-BE-SHARP**.

# SHARP

SHARP ELECTRONICS CORPORATION

Sharp Plaza, Mahwah, New Jersey 07430-2135

SHARP CORPORATION