

SHARP®

VCR/DVD RECORDER COMBINATION

MODEL

DV-RW550U

OPERATION MANUAL

Please read this Operation Manual carefully before using
your VCR/DVD RECORDER COMBINATION.

INSTRUCCIONES EN ESPAÑOL INCLUIDAS.

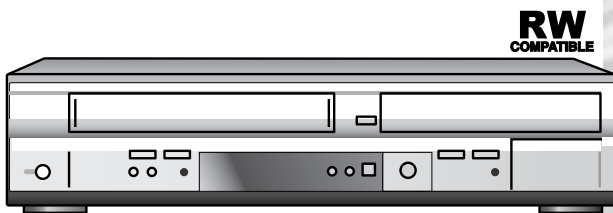

The region number for
this unit is 1.



Before you start

Connections

Getting started

Recording

Disc Playback

Editing

Changing the Setting menu

VCR functions

Others

Español

Before you start

Precautions

For future reference, record the model and serial numbers (located on the rear of the unit) in the space provided.

Model No.: DV-RW550U

Serial No.: _____

WARNING: TO REDUCE THE RISK OF FIRE OR ELECTRIC SHOCK, DO NOT EXPOSE THIS APPLIANCE TO RAIN OR MOISTURE.

CAUTION: TO PREVENT ELECTRIC SHOCK, MATCH WIDE BLADE OF PLUG TO WIDE SLOT, FULLY INSERT.

ATTENTION: POUR ÉVITER LES CHOC ÉLECTRIQUES, INTRODUIRE LA LAME LA PLUS LARGE DE LA FICHE DANS LA BORNE CORRESPONDANTE DE LA PRISE ET POUSSER JUSQU'AU FOND.



CAUTION

**RISK OF ELECTRIC SHOCK
DO NOT OPEN**



CAUTION:

TO REDUCE THE RISK OF ELECTRIC SHOCK, DO NOT REMOVE COVER (OR BACK). NO USER SERVICEABLE PARTS INSIDE. REFER SERVICING TO QUALIFIED SERVICE PERSONNEL.



This symbol warns the user of uninsulated voltage within the unit that can cause dangerous electric shocks.



This symbol alerts the user that there are important operating and maintenance instructions in the literature accompanying this unit.

WARNING—FCC Regulations state that any unauthorized changes or modifications to this equipment not expressly approved by the manufacturer could void the user's authority to operate this equipment.

This device complies with Part 15 of the FCC Rules. Operation is subject to the following two conditions:

- (1) This device may not cause harmful interference, and
- (2) this device must accept any interference received, including interference that may cause undesired operation.

INFORMATION

This equipment has been tested and found to comply with the limits for a Class B digital device, pursuant to Part 15 of the FCC Rules. These limits are designed to provide reasonable protection against harmful interference in a residential installation. This equipment generates, uses and can radiate radio frequency energy and, if not installed and used in accordance with the instructions, may cause harmful interference to radio communications. However, there is no guarantee that interference will not occur in a particular installation. If this equipment does cause harmful interference to radio or television reception, which can be determined by turning the equipment off and on, the user is encouraged to try to correct the interference by one or more of the following measures:

- Reorient or relocate the receiving antenna.
- Increase the separation between the equipment and receiver.
- Connect the equipment into an outlet on a circuit different from that to which the receiver is connected.
- Consult the dealer or an experienced radio/TV technician for help.

This Class B digital apparatus complies with Canadian ICES-003.

Cet appareil numérique de la classe B est conforme à la norme NMB-003 du Canada.

Este aparato digital de la Clase B cumple con la norma ICES-003 de Canadá.

Note to the CATV System Installer :

This reminder is provided to call the CATV system installer's attention to Article 820-40 of the National Electrical Code, which provides guidelines for proper grounding - in particular, specifying that the cable ground shall be connected to the grounding system of the building, as close to the point of cable entry as possible.

CAUTION:

THIS UNIT IS A CLASS 1 LASER PRODUCT.

USE OF CONTROLS OR ADJUSTMENTS OR PERFORMANCE OF PROCEDURES OTHER THAN THOSE SPECIFIED HEREIN MAY RESULT IN HAZARDOUS RADIATION EXPOSURE.

AS THE LASER BEAM USED IN THIS UNIT IS HARMFUL TO THE EYES, DO NOT ATTEMPT TO DISASSEMBLE THE CABINET.

REFER SERVICING TO QUALIFIED PERSONNEL ONLY.

Important Safeguards

1. Read Instructions - All the safety and operating instructions should be read before the appliance is operated.
2. Retain Instructions- The safety and operating instructions should be retained for future reference.
3. Heed Warnings - All warnings on the appliance and in the operating instructions should be adhered to.
4. Follow Instructions - All operating and use instructions should be followed.
5. Cleaning - Unplug this video product from the wall outlet before cleaning. Do not use liquid cleaners or aerosol cleaners. Use a damp cloth for cleaning.

EXCEPTION: A product that is meant for uninterrupted service and, that for some specific reason, such as the possibility of the loss of an authorization code for a CATV converter, is not intended to be unplugged by the user for cleaning or any other purpose, may exclude the reference to unplugging the appliance in the cleaning description otherwise required in item 5.

6. Attachments - Do not use attachments not recommended by the video product manufacturer as they may cause hazards.
7. Water and Moisture- Do not use this video product near water, for example, near a bath tub, wash bowl, kitchen sink, or laundry tub, in a wet basement, or near a swimming pool, and the like.
8. Accessories - Do not place this video product on an unstable cart, stand, tripod, bracket, or table. The video product may fall, causing serious injury to a child or adult, and serious damage to the appliance. Use only with a cart, stand, tripod, bracket, or table recommended by the manufacturer, or sold with the video product. Any mounting of the appliance should follow the manufacturer's instructions and should use a mounting accessory recommended by the manufacturer.

PORTABLE CART WARNING
(Symbol provided by RETAC)



S3125A

9. Transportation - A product and cart combination should be moved with care. Quick stops, excessive force, and uneven surfaces may cause the appliance and cart combination to overturn.
10. Ventilation - Slots and openings in the cabinet are provided for ventilation and to ensure reliable operation of the video product and to protect it from overheating, and these openings must not be blocked or covered. The openings should never be blocked by placing the video product on a bed, sofa, rug, or other similar surface. This video product should not be placed in a built-in installation such as a bookcase or rack unless proper ventilation is provided or the manufacturer's instructions have been adhered to.
11. Power Sources - This video product should be operated only from the type of power source indicated on the marking label. If you are not sure of the type of power supply to your home, consult your appliance dealer or local power company. For products intended to operate from battery power, or other sources, refer to the operating instructions.
12. Grounding or Polarization - This video product is equipped with a polarized alternating-current line plug (a plug having one blade wider than the other). This plug will fit into the power outlet only one way. This is a safety feature. If you are unable to insert the plug fully into the outlet, try reversing the plug. If the plug should still fail to fit, contact your electrician to replace your obsolete outlet. Do not defeat the safety purpose of the polarized plug.
13. Power Cord Protection - Power supply cords should be routed so that they are not likely to be walked on or pinched by items placed upon or against them, paying particular attention to cords at plugs, convenience receptacles, and the point where they exit from the appliance.
14. Outdoor Antenna Grounding - If an outside antenna or cable system is connected to the video product, be sure the antenna or cable system is grounded so as to provide some protection against voltage surges and built-up static charges. Article 810 of the National Electrical Code, ANSI/NFPA No. 70, pro-

vides information with regard to proper grounding of the mast and supporting structure, grounding of the lead-in wire to an antenna discharge unit, size of grounding conductors, location of antenna-discharge unit, connection to grounding electrodes, and requirements for the grounding electrode (Fig.A).

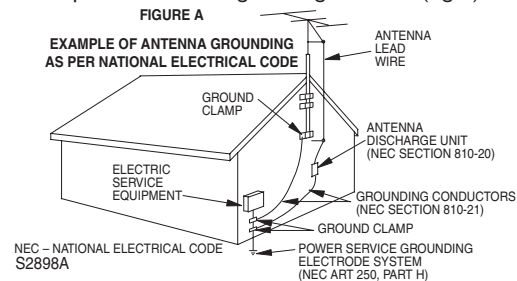

15. Lightning - For added protection for this video product during a lightning storm, or when it is left unattended and unused for long periods of time, unplug it from the wall outlet and disconnect the antenna or cable system. This will prevent damage to the video product due to lightning and power-line surges.
16. Power Lines - An outside antenna system should not be located in the vicinity of overhead power lines or other electric light or power circuits, or where it can fall into such power lines or circuits. When installing an outside antenna system, extreme care should be taken to keep from touching such power lines or circuits as contact with them might be fatal.
17. Overloading - Do not overload wall outlets and extension cords as this can result in a risk of fire or electric shock.
18. Object and Liquid Entry - Never push objects of any kind into this video product through any openings as they may touch dangerous voltage points or short-out parts that could result in a fire or electric shock. Never spill liquid of any kind on the video product.
19. Servicing - Do not attempt to service this video product yourself as opening or removing covers may expose you to dangerous voltage or other hazards. Refer all servicing to qualified service personnel.
20. Damage Requiring Service - Unplug this video product from the wall outlet and refer servicing to qualified service personnel under the following conditions:
 - a. When the power-supply cord or plug is damaged.
 - b. If liquid has been spilled, or objects have fallen into the video product.
 - c. If the video product has been exposed to rain or water.
 - d. If the video product does not operate normally by following the operating instructions. Adjust only those controls that are covered by the operating instructions as an improper adjustment of other controls may result in damage and will often require extensive work by a qualified technician to restore the video product to its normal operation.
 - e. If the video product has been dropped or damaged in any way.
 - f. When the video product exhibits a distinct change in performance this indicates a need for service.
21. Replacement Parts - When replacement parts are required, be sure the service technician has used replacement parts specified by the manufacturer or have the same characteristics as the original part. Unauthorized substitutions may result in fire, electric shock or other hazards.
22. Safety Check - Upon completion of any service or repairs to this video product, ask the service technician to perform safety checks to determine that the video product is in proper operating condition.
23. Heat - This video product should be situated away from heat sources such as radiators, heat registers, stoves, or other products (including amplifiers) that produce heat.

Before you start

Precautions (cont'd)

Location and Handling

Location and Handling

- Do not stand the unit vertically. Install the unit in a horizontal and stable position. Do not place anything directly on top of the unit. Do not place the unit directly on top of the TV.
- Do not cover or place the unit in enclosed spaces to prevent excessive temperature build up.
- Do not place the unit in direct sunlight, or near heat sources.
- Depending on the use environment, the temperature of the unit may increase slightly. This is not a malfunction.
- Keep the unit away from strong magnetic objects.
- Do not place any object containing water or other liquids on the unit. In the event that liquid should enter the cabinet, unplug the unit immediately and contact the retailer or service centre approved by SHARP immediately.
- Do not remove the unit cabinet. Touching parts inside the cabinet could result in electric shock and/ or damage to the unit. For service and adjustment inside the cabinet, call a qualified dealer or service centre approved by SHARP.
- Be sure to remove a disc and videotape, and unplug the AC power cord from the outlet before carrying the unit.

Nonuse Periods

Location and Handling

- When the unit is not being used, switch the unit to the Standby mode.
- When left unused for a long period of time, the unit should be unplugged from the household AC outlet.
- Do not place the unit in direct sunlight, or near heat sources.

Copy Protection

This unit supports Macrovision copy protection.

On DVD discs that include a copy protection code, if the contents of the DVD disc are copied using this unit, the copy protection code prevents the DVD or videotape copy from playing normally.

U.S. Patent Nos. 4,631,603; 4,577,216; 4,819,098; 4,907,093; 5,315,448; and 6,516,132.

This product incorporates copyright protection technology that is protected by U.S. patents and other intellectual property rights. Use of this copyright protection technology must be authorized by Macrovision, and is intended for home and other limited viewing uses only unless otherwise authorized by Macrovision. Reverse engineering or disassembly is prohibited.

Notice for progressive scan outputs

Consumers should note that not all high definition television sets are fully compatible with this product and may cause artifacts to be displayed in the picture. In case of picture problems with 525p progressive scan output, it is recommended that the user switch the connection to the 'standard definition' output. If there are questions regarding your TV set compatibility with this model 525p DVD recorder, please contact our customer service center.

No Fingers or Other Objects Inside

Do not put your fingers or objects on the disc tray or in the cassette compartment.

Warning of Dew Formation

Moisture may form inside the unit under the following conditions:

- Immediately after a heater is turned on.
- In a steamy or humid room.
- When the unit is suddenly moved from a cold to warm environment.

If moisture forms inside the unit, it may not operate properly or damage the videotape. In such case, turn on the power and wait for more than two hours for the moisture to evaporate.

Manufactured under license from Dolby Laboratories. "Dolby" and the double-D symbol are trademarks of Dolby Laboratories.

"DTS" and "DTS Digital Out" are trademarks of Digital Theater Systems, Inc.

 is a trademark of DVD Format/Logo Licensing Corporation.

Dolby Digital Recording

"Dolby® Digital Recording enables consumers to record high-quality video with stereo sound on recordable DVD discs. The technology, when utilized instead of PCM recording, also saves recordable disc space, allowing for higher video resolution or extended recording time on each DVD. DVDs created using Dolby Digital Recording will play back on all DVD-Video players."

Note:

This is true when the players are compatible with actual recordable DVD discs.

Before you start

Precautions (cont'd)

Others

It is the intent of SHARP that this product be used in full compliance with the copyright laws of the United States and that prior permission be obtained from copyright owners whenever necessary.

"Licensed under one or more of U.S. Pat. 4,972,484, 5,214,678, 5,323,396, 5,530,655, 5,539,829, 5,544,247, 5,606,618, 5,610,985, 5,740,317, 5,777,992, 5,878,080, or 5,960,037."

Maintenance

SERVICING

1. Please refer to relevant topics in the Troubleshooting on pages 98-101 before returning the product.
2. Do not attempt to service this unit yourself. Instead, unplug it and contact a SHARP Authorized Service Center for inspection. (See **CONSUMER LIMITED WARRANTY** at the end of this manual.)
3. Be sure the service technician uses authorized replacement parts or their equivalents. Unauthorized parts may cause fire, electrical shock, or other hazards.
4. Following any service or repair, be sure the service technician performs safety checks to certify that this unit is in safe operating order.

CLEANING THE CABINET

- Use a soft cloth slightly moistened with a mild detergent solution. Do not use a solution containing alcohol, spirits, ammonia or abrasive.

CLEANING DISCS

- When a disc becomes dirty, clean it with a cleaning cloth. Wipe the disc from the center out. Do not wipe in a circular motion.
- Do not use solvents such as benzene, thinner, commercially available cleaners, detergent, abrasive cleaning agents or antistatic spray intended for analogue records.

RECOMMENDED MEASURES FOR OPTIMUM PICTURE EXCELLENCE

This unit is a precision device constructed using extremely accurate technology.

- The disc cannot be played if the disc drive component is worn out or if the internal pickup lens is dirty.
- If this unit still does not perform properly although you refer to the relevant sections and to Troubleshooting on pages 98-101, the laser optical pickup unit may be dirty. Consult a SHARP Authorized Service Center for inspection and cleaning of the laser optical pickup unit.

DISC HANDLING

- When you handle a disc, hold it by its edge and try not to touch the surface of the disc.
- Always store a disc in its protective case when it is not used.

AUTO HEAD CLEANING

- Automatically cleans video heads as you insert or remove a videotape, so you can see a clear picture.
- Playback picture may become blurred or interrupted while the TV program reception is clear. Dirt accumulated on the video heads after a long period of use, or the usage of rental or worn videotape can cause this problem. If a streaky or snowy picture appears during playback, the video heads in your unit may need to be cleaned.

1. Please visit your local Audio/Video store and purchase a good quality VHS Video Head Cleaner.
2. If a Video Head Cleaner does not solve the problem, please call our help line mentioned on page 104 to locate a SHARP Authorized Service Center.

Supplied Accessory

- Remote control with two "AA" size batteries
- Round Coaxial cable
- Audio/Video cables
- Operation Manual
- Quick Use Guide

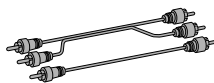
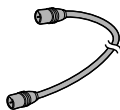

Before you start

Table of contents

Before you start	2	Search	56
Precautions	2	Title/Chapter search	56
Table of contents	6	Track search	57
Features	7	Time search	57
Symbols in this operation manual	7	Repeat/Random/Program playback	58
Functional overview	8	Repeat playback	58
Installing batteries in the remote control	10	Random playback	59
Using a remote control	10	Program playback	59
The VCR/DVD recorder Switching	10	Selecting a format of audio and video	60
Setting/Disc/CD menus	11	Switching audio soundtracks	60
DISPLAY menu	12	Switching subtitles	61
Connections	14	Switching camera angles	62
Connection to a TV	14	Visual Noise Reduction	62
Connection to a cable box or satellite box	15	Editing	63
Connection to an Audio System	16	Information on disc editing	63
Getting started	17	Guide to a Title List	63
Easy DVD recording	17	Editing discs in Video mode	63
Channel setting	19	Editing discs in VR mode	64
Getting channels automatically	19	Editing DVD-RW discs in Video mode	65
Adding/Deleting channels	20	Deleting titles	65
Selecting the TV Stereo or SAP	21	Putting names on titles	66
Setting the clock	22	Setting or clearing chapter markers	68
Auto Clock Setting	22	Editing DVD-RW discs in VR mode (Original) ..	69
Manual Clock Setting	23	Deleting titles	69
Setting the Daylight Saving Time	24	Setting titles to protect	70
Selecting the TV aspect ratio	25	Releasing titles from protecting	71
Recording	26	Editing DVD-RW discs in VR mode (Playlist) ..	72
Information on DVD recording	26	Deleting titles	72
Information	26	Deleting parts of titles	73
Recordable disc	26	Putting names on titles	74
Recording speed	26	Setting or clearing chapter markers	76
Restrictions on recording	27	Setting pictures for thumbnails	78
Information on copy control	27	Dividing a title	79
Making discs playable on other DVD player (Finalize) ..	27	Combining titles	80
Formatting a disc	28	Adding titles to a Playlist	81
Choosing the recording format of a blank disc	28	Deleting a Playlist	82
Reformatting a disc	29	Editing DVD-R discs	83
Auto Chapter	30	Deleting titles	83
Recording Audio Select (XP)	31	Putting names on titles	84
Basic recording	32	Changing the Setting menu	86
Checking the recording picture and sound quality ..	33	Tour of the Setting menu	86
One-touch Timer Recording	34	Language setting	87
Timer Recording	35	Display setting	89
Hints for Timer Recording	39	Audio setting	91
Settings for an external source	40	Settings for Parental lock level	93
Connection to an external source	40	VCR functions	95
Recording from an external source	41	Playback	95
Setting a disc to protect	41	Recording and One-touch Timer Recording ..	95
Dubbing Mode	42	Recording	95
Finalizing the discs	44	One-touch Timer Recording	96
Auto finalize	45	Search	96
Disc Playback	46	Index search	96
Information on DVD playback	46	Time search	97
Guide to displays	46	Other operations	97
Basic playback	47	Others	98
Playback	47	Troubleshooting	98
Playing back discs using the disc menu	49	RF converter output	101
Playing back discs using the title menu	50	Language code	102
Special playback	51	Glossary	103
Resume playback	51	Specifications	104
Fast forward / Fast reverse	51	Service Information (For the U.S.)	104
Skipping TV commercials during playback	52	Español	105
Pause	52		
Step by step playback	53		
Slow forward / Slow reverse playback	53		
Zoom	54		
Marker Setup	55		

Before you start

Features

This unit not only plays back DVDs, CDs and VHS tapes but also offers features for you to record on DVD discs and edit them after that. The following features are offered with this unit.

Recording

DVD MODE VCR MODE

This unit is compatible with both DVD-RW, which is rewritable repeatedly, and DVD-R, which is available for one time recording only. Also, this unit allows you to record to the videotape. You can choose either one for your convenience.

Recording up to 8 programs:

You can program the unit to record up to 8 programs within a month in advance. Daily or weekly program recordings are also available.

One-touch Timer Recording:

You can easily set recording time as you prefer. Every time **REC/OTR** on the remote control or on the front panel is pressed during recording, the recording time will be increased by 30 minutes up to 8 hours. The recording automatically stops when it reached to the recording time you set.

Dubbing mode:

You can copy a DVD disc to a videotape or copy a videotape to a DVD disc. This function will be possible only if the DVD disc or a videotape is not copy protected.

You cannot record on a videotape when its erase-protection tab is removed.

Left channel stereo recording:

This unit can record the Left channel monaural sound as Left and Right channel sound automatically.

DVD MODE

REC MONITOR:

You can confirm the picture and the sound quality for recording of the current recording speed which you set. If you want to change the recording speed, press **REC MODE** to select a desired recording speed.

Automatic Chapter marker setting:

You can mark each title of recording with chapter markers as you set in setting menu before recording.

Automatic Title menu making (Video mode):

The unit makes title menus automatically when finalizing the disc.

Automatic Playlist making (VR mode):

A Playlist will be prepared from an Original, so that you can edit titles on a Playlist as you prefer. An Original is kept as it is.

Automatic finalizing (Video mode):

The unit can finalize discs automatically after finishing all Timer Recordings or when the disc runs out recordable space.

Playback

DVD MODE

Theater quality sound at your home:

When connecting the unit to an amplifier or a decoder which is compatible with Dolby Digital or DTS, you can experience the theater quality sound environment.

Quick search for what you want to watch:

You can easily find the part you want to watch using title, chapter or time search functions.

Start playback from Original and Playlist (VR mode):

You can play back titles from either the Original or the Playlist.

VCR MODE

Quick search for what you want to watch:

You can easily find the part you want to watch using the Index search/Time search functions. An index mark will be assigned at the beginning of each recordings you make. For Time search function, you can go to a specific point on a videotape by entering the exact amount of time you wish to skip.

Editing

DVD MODE

Deleting titles:

You can delete titles which you do not need anymore.

Making your own Playlist (VR mode):

With the Original remains as it is, you can edit titles on various Playlist as you prefer.

- Putting names on titles.
- Setting pictures for thumbnails.
- Setting/clearing chapter markers.
- Dividing/Combining titles.
- Deleting parts of titles, etc.

Protecting titles (VR mode):

You can prevent accidental editing or title erasing with protect function.

Compatibility

DVD MODE

Playback of discs recorded in Video mode on a other DVD player (Video mode):

Discs recorded in Video mode can be played back on other DVD players, including computer DVD drives compatible with DVD-Video playback*. You will need to finalize the discs recorded in Video mode to play them back on other DVD players.

* DVD-Video Format (Video mode) is a new format for recording on DVD-RW/R-R discs that was approved by the DVD Forum in 2000. Adoption of this format is optional for manufactures of DVD playback devices, and there are DVD-Video players, DVD-ROM drives or other DVD playback devices that do not play back DVD-RW/R-R discs recorded in the DVD-Video Format.

Others

Progressive scan system

Unlike conventional interlace scanning, the progressive scan system provides less flickering and higher resolution images than the traditional scanning system does.

Symbols in this operation manual

To show what recording speed or disc type applies to each function, the following symbols appear at the beginning of each operating item.

Symbol	Description
	Available to DVD-Video discs
	Available to DVD-RW in Video mode
	Available to DVD-RW in VR mode
	Available to DVD-R in Video mode
	*Available to DVD+RW discs
	*Available to DVD+R discs
	Available to Audio CDs
	Available to CD-RW/-R discs with MP3 files
	Available to VHS tapes Use only VHS tapes marked with this unit.
	Indicates that you need to select the DVD mode by pressing DVD on the remote control before proceeding next step.
	Indicates that you need to select the VCR mode by pressing VCR on the remote control before proceeding next step.

* Some DVD+RW/+R discs may not be operated properly because the unit conforms to the discs recorded in DVD-RW/-R format.

Before you start

Functional overview

Front Panel

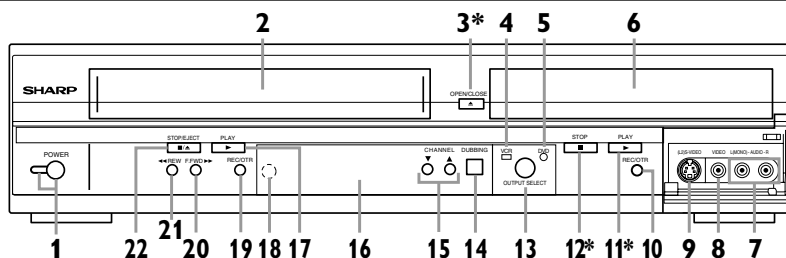

(*) The unit can also be turned on by pressing these buttons.

1. **POWER button / indicator (DVD/VCR)**
Press to turn on and off the unit.
Red LED lights up when power is on.
2. **Cassette compartment (VCR)**
Insert a videotape here.
3. **OPEN/CLOSE ▲ button (DVD)***
Press to open or close the disc tray.
4. **VCR indicator**
Appears when the VCR output mode is selected.
5. **DVD indicator**
Appears when the DVD output mode is selected.
6. **Disc tray (DVD)**
Place a disc when it is opened.
7. **AUDIO INPUT jacks (LINE2) (DVD/VCR)**
Use to connect external equipment with standard audio cables.
8. **VIDEO INPUT jack (LINE2) (DVD/VCR)**
Use to connect external equipment with a standard video cable.
9. **S-VIDEO INPUT jack (LINE2) (DVD/VCR)**
Use to connect the S-Video output of external equipment with an S-Video cable.
10. **REC/OTR button (DVD)**
Press once to start recording.
Press repeatedly to start a One-Touch timer Recording.
11. **PLAY ► button (DVD)***
Press to start or resume playback.
12. **STOP ■ button (DVD)***
Press to stop playback or recording.
Press to stop the proceeding timer recording in DVD.
13. **OUTPUT SELECT button (DVD/VCR)**
Press to select the component you wish to operate.
14. **DUBBING button (DVD/VCR)**
Press to start VCR to DVD (DVD to VCR) duplication which you set in the setting menu.
15. **CHANNEL ▼ / ▲ buttons (DVD/VCR)**
Press to change the channel up and down.
16. **Display**
Shows various information and messages.
17. **PLAY ► button (VCR)**
Press to start playback.
18. **Remote control sensor (DVD/VCR)**
Receive signals from your remote control so that you can control the unit from a distance.
19. **REC/OTR button (VCR)**
Press once to start a recording.
Press repeatedly to start a One-Touch timer Recording.
20. **F.FWD ►► button (VCR)**
Press to rapidly advance the videotape, or view the picture rapidly in forward during playback (Forward Search).
21. **REW ◀◀ button (VCR)**
Press to rewind the videotape, or to view the picture rapidly in reverse during the playback mode (Rewind Search).
22. **STOP/EJECT ■/▲ button (VCR)**
EJECT ▲ button - Press to remove the videotape from the cassette compartment when the power is on or off.
STOP ■ button - Press to stop videotape playback or recording.
Press to stop the proceeding timer recording in VCR.

Rear Panel

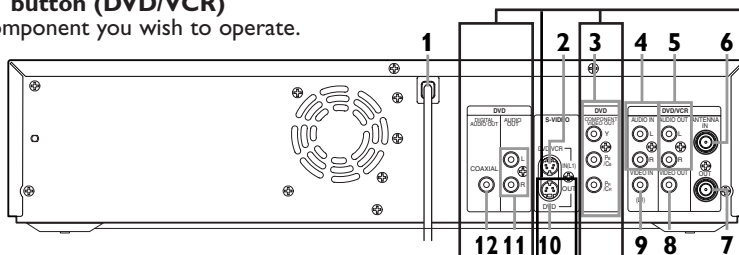

1. **AC Power Cord (DVD/VCR)**
Connect to a standard AC outlet to supply power to this unit.
2. **S-VIDEO INPUT jack (LINE1) (DVD/VCR)**
Use to connect the S-Video output of external equipment with an S-Video cable.
3. **COMPONENT VIDEO OUTPUT jacks (DVD only)**
Use to connect a TV monitor with component video inputs with component video cables.
4. **AUDIO INPUT jacks (LINE1) (DVD/VCR)**
Use to connect external equipment with standard audio cables.
5. **AUDIO OUTPUT jacks (DVD/VCR)**
Use to connect a TV monitor, AV receiver or other equipment with standard audio cables.
6. **TV ANTENNA IN jack (DVD/VCR)**
Use to connect an antenna.
7. **TV ANTENNA OUT jack (DVD/VCR)**
Use to connect an antenna cable to pass the signal from the TV ANTENNA IN to your TV monitor.
8. **VIDEO OUTPUT jack (DVD/VCR)**
Use to connect a TV monitor, AV receiver or other equipment with a standard video cable.
9. **VIDEO INPUT jack (LINE1) (DVD/VCR)**
Use to connect external equipment with a standard video cable.
10. **S-VIDEO OUTPUT jack (DVD only)**
Use to connect the S-Video input of a TV monitor, AV receiver or other equipment with an S-Video cable.
11. **AUDIO OUTPUT jacks (DVD only)**
Use to connect a TV monitor, AV receiver or other equipment with standard audio cables.
12. **COAXIAL DIGITAL AUDIO OUTPUT jack (DVD only)**
Use to connect an AV receiver, Dolby Digital decoder, DTS decoder or other equipment with a coaxial digital input jack with a digital coaxial cable.

• These jacks are useful only in DVD mode.

Note

Do not touch the inner pins of the jacks on the rear panel. Electrostatic discharge may cause permanent damage to the unit.

Remote Control

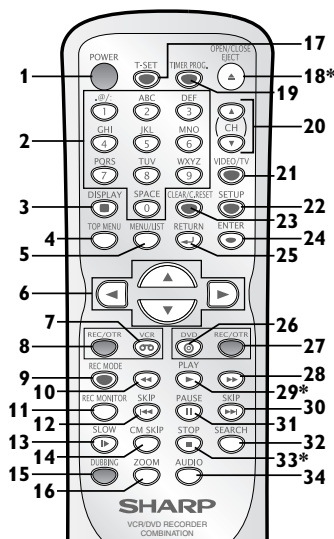

(*) In DVD mode, the unit can also be turned on by pressing these buttons.

1. **POWER button (DVD/VCR)**
Press to turn on and off the unit.
2. **Number buttons (DVD/VCR)**
Press to select channel numbers. Press to select a title/chapter/track on display or a TV channel. Press to enter values for the settings in the setting menu.
3. **DISPLAY button (DVD/VCR)**
Press to display the On-screen display.
4. **TOP MENU button (DVD)**
Press to display the top menu.
5. **MENU/LIST button (DVD)**
Press to display the Disc menu. Press to change Original and Playlist on the TV screen. (VR mode only)
6. **Cursor ▲ / ▼ / ◀ / ▶ buttons (DVD/VCR)**
Press to select items or settings.
7. **VCR button**
Press to activate the remote control in VCR mode. (Refer to page 10)
Press to select the VCR output mode.
8. **REC/OTR button (VCR)**
Press to activate the remote control in VCR mode. (Refer to page 10)
Press once to start a recording. Press repeatedly to start a One-Touch timer Recording.
9. **REC MODE button (DVD/VCR)**
Press to change the recording speed.
10. **◀◀ button (DVD/VCR)**
• DVD mode
During playback, press to play back in fast reverse.
Or when playback is paused, press to play back in slow reverse.
• VCR mode
Press to rewind the videotape or to view the picture rapidly in reverse during the playback mode.
11. **REC MONITOR button (DVD)**
Press to check the video and audio signals for recording.
12. **SKIP ◀◀ button (DVD)**
During playback, press to skip to the previous chapter or track. Or when playback is paused, press to play back in reverse step by step.
13. **SLOW ▶▶ button (VCR)**
During playback, press to view the videotape in slow motion.
14. **CM SKIP button (DVD)**
During playback, press to skip to the 30-second advanced point.
15. **DUBBING button (DVD/VCR)**
Press to start VCR to DVD (DVD to VCR) duplication which you set in the setting menu.
16. **ZOOM button (DVD)**
During playback, press to enlarge the picture on the screen.
17. **T-SET button**
Press to set the unit in the timer standby mode. In the timer standby mode, press to cancel the mode and to turn the unit on.
18. **OPEN/CLOSE EJECT ▲ button ***
• DVD mode
Press to open or close the disc tray.
• VCR mode
Press to remove the videotape from the cassette compartment when the power is on or off.
19. **TIMER PROG. button (DVD/VCR)**
Press to display the timer program setting menu.
20. **CH ▲ / ▼ buttons (DVD/VCR)**
• DVD mode
Press to change the channel up and down.
• VCR mode
Press to change the channel up and down.
Press to adjust the tracking during playback or in slow motion of the videotape. Also while playback is in still mode, you can adjust the picture blurred vertically.
21. **VIDEO/TV button (DVD/VCR)**
Press to select VIDEO or TV position.
22. **SETUP button (DVD/VCR)**
Press to display the setting menu.
23. **CLEAR/C.RESET button (DVD/VCR)**
Press to clear the program once entered in the timer recording setting menu
• DVD mode
Press to clear the password entered, to cancel the programming for CD, to clear the highlighted marker number in the marker setup mode, etc.
• VCR mode
Press to reset the tape counter.
24. **ENTER button (DVD/VCR)**
Press to confirm or select menu items.
25. **RETURN ↵ button (DVD/VCR)**
Press to return to the previously displayed menu screen.
26. **DVD button**
Press to activate the remote control in DVD mode. (Refer to page 10)
Press to select the DVD output mode.
27. **REC/OTR button (DVD)**
Press to activate the remote control in DVD mode. (Refer to page 10)
Press once to start a recording. Press repeatedly to start a One-Touch timer Recording.
28. **▶▶ button (DVD/VCR)**
• DVD mode
During playback, press to play back in fast forward.
Or when playback is paused, press to play back slow forward.
• VCR mode
Press to rapidly advance the videotape or view the picture rapidly in forward during playback.
29. **PLAY ▶ button ***
(DVD/VCR)
Press to start or resume playback.
30. **SKIP ▶▶ button (DVD)**
During playback, press to skip to the next chapter or track. Or when playback is paused, press to play back in forward step by step.
31. **PAUSE || button (DVD/VCR)**
Press to pause playback or recording.
32. **SEARCH button (VCR)**
Press to call up the index or time search menu.
33. **STOP ■ button ***
(DVD/VCR)
Press to stop playback or recording.
34. **AUDIO button (VCR)**
During playback a HiFi videotape, press to change the AUDIO OUT setting "HiFi" and "MONO".

Before you start

Functional overview (cont'd)

Installing batteries in the remote control

Install two "AA" size batteries (supplied), matching their polarity to those indicated inside battery compartment of the remote control.

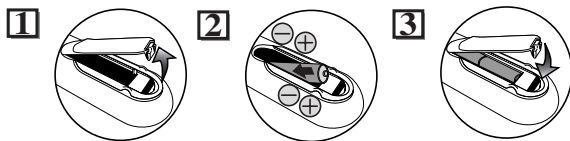

Note

Incorrect use of batteries can result in hazards such as leakage and bursting. Please follow the instruction below.

- Do not mix new and old batteries together.
- Do not use different kinds of batteries together. Although they may look similar, different batteries may have different voltages.
- Make sure that the plus and minus ends of each battery match the indications in the battery compartment.
- Remove batteries from equipment that is not going to be used for a month or more.
- When disposing of used batteries, please comply with governmental regulations or public rules for environmental protection that apply in your country or area.
- Do not recharge, short-circuit, heat, burn or disassemble batteries.

Using a remote control

Keep in mind the following when using the remote control:

- Make sure that there is no obstacle between the remote control and the remote sensor of the unit.
- Remote operation may become unreliable if strong sunlight or fluorescent light is on the remote sensor of the unit.
- Remote control for different devices can interfere with each other. Avoid using remote control for other equipment located close to the unit.
- Replace the batteries when you notice a fall-off of the operating range of the remote control.
- The maximum operable range as follows;

Beeline: approximately 23 feet (7m)

Either side of center: approximately 16 feet (5m) within 30 degrees

Above: approximately 16 feet (5m) within 15 degrees

Below: approximately 10 feet (3m) within 30 degrees

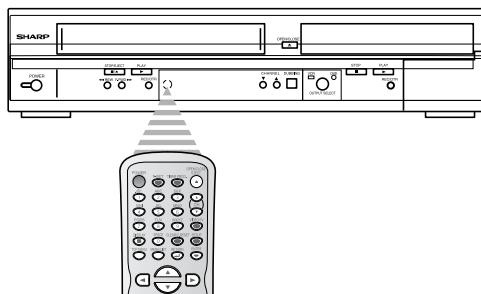

The VCR/DVD recorder Switching

Because this product is a combination of a VCR and a DVD recorder, you must select first which component you wish to operate with **OUTPUT SELECT**.

VCR MODE

Press **VCR** on the remote control.
(Verify that the VCR indicator is lit.)

DVD MODE

Press **DVD** on the remote control.
(Verify that the DVD indicator is lit.)

Note

- Pressing only **OUTPUT SELECT** on the front panel **DOES NOT** switch the mode of the remote control. You **MUST** select the correct mode on the remote control.
- Pressing **REC/OTR** (DVD) or **REC/OTR** (VCR) on the remote control switches immediately it's respective mode so that you can start recording directly on the appropriate media.

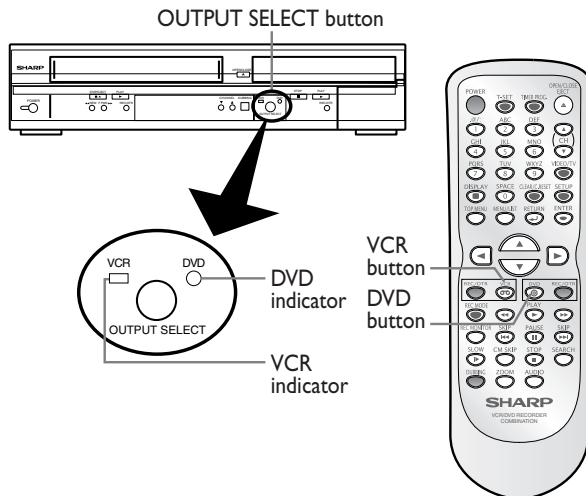

Before you start

Functional overview (cont'd)



Guide to Displays on-screen menu

This unit uses the following on-screen menu for most operations: Easy Setting Menu, Advanced Setting Menu, Title List, and DISPLAY menu. They allow you to change the playback status of the disc during playback. The DISPLAY menu also gives you information on the playback status of the disc or a videotape.

Setting/Disc/CD menus

Press **SETUP** to display Easy Setting Menu or Advanced Setting Menu. Choose either Menu using **Cursor** ▲ / ▼, then press **ENTER** to display it.

These menus allow you to perform all main functions and change important settings.

Easy Setting Menu consists of the setting menus frequently needed. Items with  mark indicate such setting menus. This operation manual explains operation procedures using Advanced Setting Menu screen. However, you can skip several steps in Advanced Setting Menu by choosing Easy Setting Menu for the items with  mark. The steps which can be skipped are specified next to  mark.

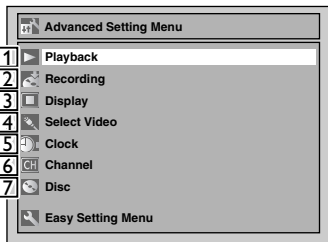
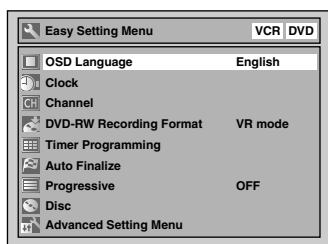

1. Playback:

To set up the unit to play back discs as you prefer.

2. Recording:

To set up the unit to record on discs or tapes as you prefer.

3. Display:

To set up the OSD screen and the front display of the unit as you prefer.

4. Select Video:

To choose a line input to record on DVD discs or tapes from other video equipment.

5. Clock:

To set up the clock of the unit.

6. Channel:

To adjust the channel setting of the unit as you prefer.

7. Disc / CD Playback Mode:

“Disc” is available only when a DVD-RW and a DVD-R only in Video mode disc is inserted into the unit. When a DVD-Video disc (commercially available), a new DVD-R disc or a finalized DVD-R disc is inserted into the unit, you cannot select “Disc”. “CD Playback Mode” is available only when an Audio CD disc, a CD-RW/-R disc with MP3 is inserted into the unit.

Screen for DVD-RW, DVD-R (Video mode):



Screen for DVD-RW (VR mode):

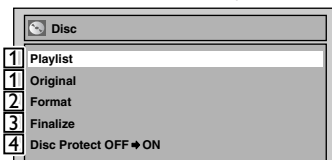

1. Title List / Playlist / Original:

Turns on a Title List, Playlist or Original, which shows the recorded titles on the disc.

2. Format (DVD-RW only):

Allows you to erase all of the recorded content on the disc. The disc will be completely blank.

- Erased content cannot be retrieved.
- A DVD-RW disc formatted with this unit cannot be used on other DVD recorders for recording.
- If you want to use a disc formatted with this unit on another DVD recorder, you have to reformat the disc on that recorder.

3. Finalize / Undo Finalize:

Allows you to finalize a disc with titles recorded with this unit. Undo Finalize reverses the finalized condition to the original, unfinalized one.

- In Video mode, you cannot Undo Finalize DVD-RW discs finalized by machines manufactured by other companies and any DVD-R discs. Some of our recorder models may not be able to Undo Finalize DVD-RW discs finalized by this unit.
- In VR mode, you can Undo Finalize any DVD-RW discs, including the ones finalized by machines manufactured by other companies.
- If you protect a disc by setting Disc Protect ON after finalizing it, you cannot use other editing functions (Playlist, Original, Format, and Undo Finalize).

4. Disc Protect (VR mode only):

Allows you to protect a disc from accidental editing or recording.

Screen for Audio CD:

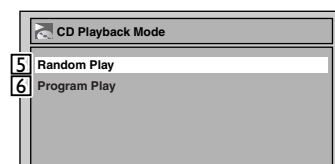

5. Random Play:

To activate the random playback feature.

6. Program Play (Audio CD):

To activate the programmed playback feature.

Note

- This is an example screen only for explanation. Displayed items are depending on the disc you inserted.

Before you start

Functional overview (cont'd)

DISPLAY menu

DVD mode



Press **DISPLAY** to call up the display menu. This menu will give you the information on the disc. Some operations are available while disc is played back.

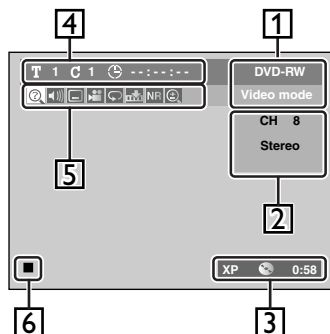

1. Indicates a disc type and a format mode.
Note:
In some descriptions on this manual, only one disc type is indicated as an example.
2. Indicates a current channel number and an audio status of the program.
3. Indicates a recording speed and possible recording time left.
4. Indicates a title number, chapter number, and the time elapsed of disc playback.

5. Each icon means:
 - : Search
 - : Audio
 - : Subtitle
 - : Angle (except VR mode)
 - : Repeat
 - : Marker
 - : Noise Reduction
 - : Zoom
6. Indicates current disc status.

Note

- This is an example screen only for explanation. Displayed items are depending on the actual mode.
- Display function is not available when the disc is not inserted.

VCR mode



Press **DISPLAY** to call up the display menu.

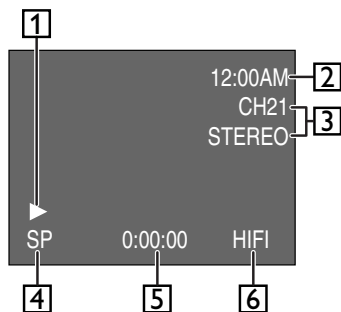

1. Indicates current video status.
2. Indicates the current time.
3. Indicates a current channel number and an audio status of the program.
4. Indicates a recording or playing speed.
5. Indicates a Tape Counter.
6. Audio status of the current playing back the videotape.

Note

- This is an example screen only for explanation. Displayed items are depending on the actual mode.

Functional overview (cont'd)

Front Panel Display Guide

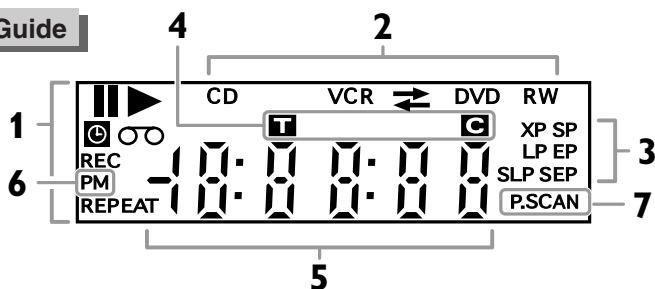

1. Current status of the unit

- : Appears when a disc or a videotape play is paused.
- : Appears when playing back a disc or a videotape.
- : Appears when the timer programming or OTR has been set and is proceeding. Flashes when all Timer Recording have been finished.
- REC** : Appears during recording process. Flashes when a recording pauses.
- REPEAT** : Appears during repeat playback (disc playback only).
- : Appears when a videotape is in the unit.

2. Disc type and Current status of the unit

- CD** : Appears when an audio CD is on the disc tray.
- DVD** : Appears when a DVD disc is on the disc tray. Appears when the timer recording is proceeding in DVD.

Appears when DVD is in the timer recording standby mode. Flashes when a program cannot be performed for some reasons.

- DVD R** : Appears when a DVD-R disc is on the disc tray.
- DVD RW** : Appears when a DVD-RW disc is on the disc tray.
- VCR** : Appears when the timer recording is proceeding in VCR. Appears when VCR is in the timer recording standby mode. Flashes when a program cannot be performed for some reasons.
- VCR→DVD** : Appears during VCR to DVD duplication process.
- VCR←DVD** : Appears during DVD to VCR duplication process.

3. Recording speed

Indicates the recording speed of the disc or a videotape.

4. Title/Track and Chapter mark

- : Appears when indicating a title/track number.
- : Appears when indicating a chapter number.

5. Displays the following

- Played-back time/remaining time
- Current title/chapter/track number
- Recording time
- Clock
- Channel number
- VCR tape counter
- Remaining time for a one-touch timer recording

6. PM

Appears in the afternoon with the clock display.

7. P.SCAN

Appears when the progressive scan system is activated.

- During Timer Recording or timer standby mode on one component, , **REC** mark (during Timer Recording), **DVD**, **VCR** indicator will disappear when the unit switches to the other component. However, the function indicated by each mark is still working. (It does not mean the cancellation of Timer Recording or timer standby mode.)

Display message



Appears when the disc tray is opening.



Appears when a disc is loaded on the disc tray.



Appears when the disc tray is closing.



Appears when data is being recorded on a disc.

Note

• Time display during recording/playback

The recording time and playback time of this unit will display about 0.1% faster than the real recording/playback time. When broadcasting images, 29.9 frames are sent per second. This unit calculates 30 frames as one second. For this reason, time will display about 0.1% faster. For example, if you record for 1 hour, in reality there will be 1 hour of recorded material. However, the time display on this unit will be "60 min. X 0.999 = 59.94 min. = 59 min. 56 sec.".

Connections

Connection to a TV

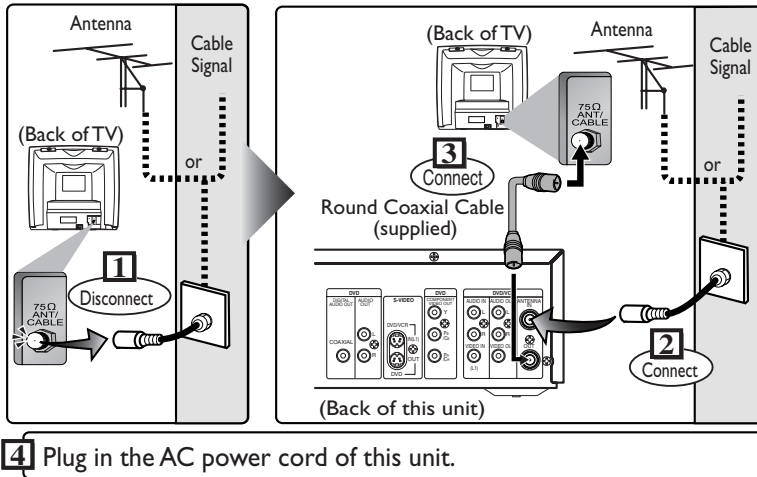

Make one of the following connections, depending on the capabilities of the equipment you possess.

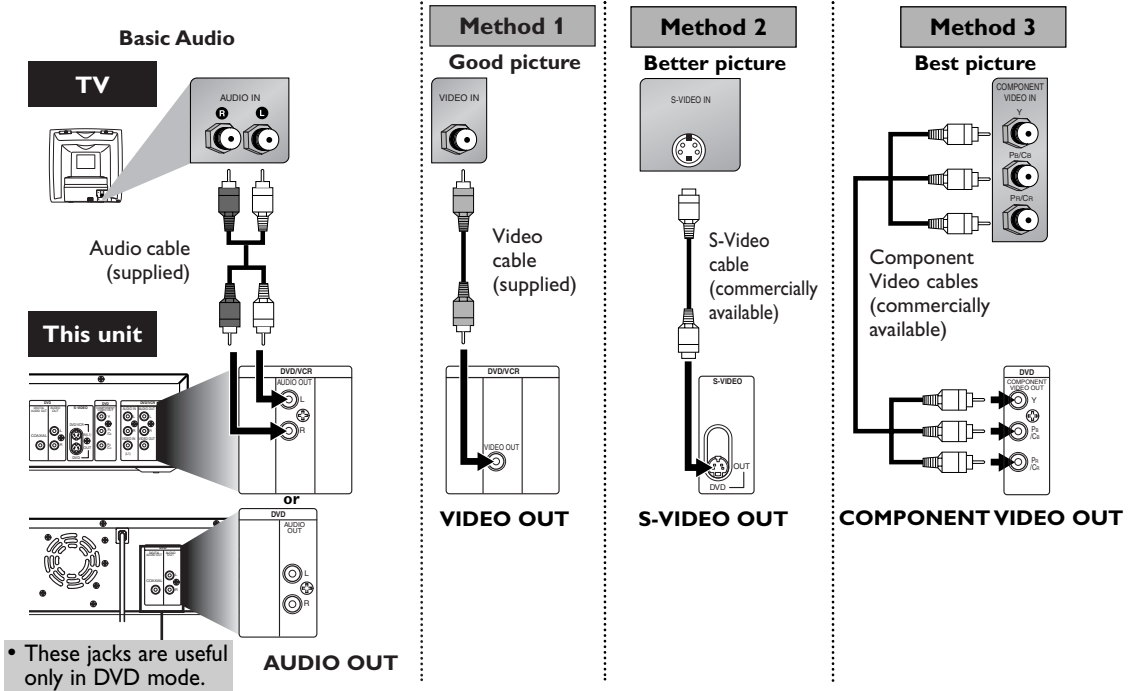

Note

- Connect this unit directly to the TV. If the Audio/Video cables are connected to a VCR, pictures may be distorted due to the copy protection system.
- Method 2 and method 3 are only useful in DVD mode.
- Although you can view images when using the connection Method 1 and 2 while progressive scan is activated, they are in interlace mode.

If your TV is compatible with progressive scan (525p / 480p) and you want to enjoy that high quality picture;

You must select the connection Method 3 above and progressive scan mode. To set the mode, press **SETUP** and set "Progressive" to "ON" on the Easy Setting Menu, or on the "Playback" sub menu of the Advanced Setting Menu. Then press **ENTER**. "PSCAN" will appear on the display of this unit.

If your TV is not compatible with progressive scan;

Use this unit in interlace mode. Make sure that no "PSCAN" is on the display of this unit. If not, press **SETUP** and set "Progressive" to "OFF" on the Easy Setting Menu, or on the "Playback" sub menu of the Advanced Setting Menu. Then press **ENTER**. "PSCAN" on the display of this unit will disappear.

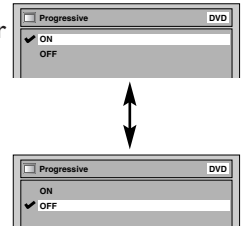

Connections

Connection to a cable box or satellite box

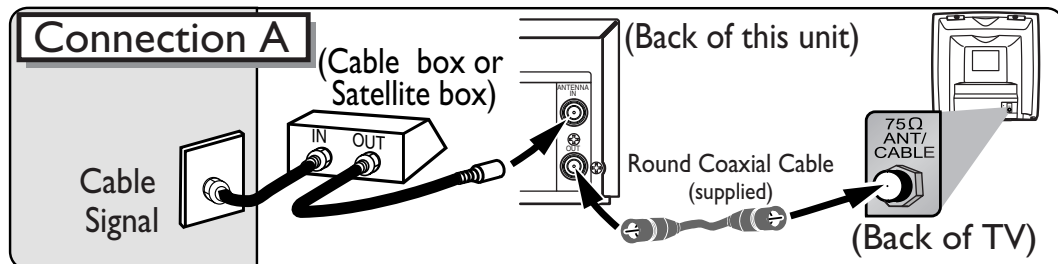

Select this connection when you want to view or record a scrambled channel. With this connection, channels cannot be changed on this unit. You can view or record ONLY the channels you have selected on the cable box or the satellite box.

- While you are recording, only the recorded channel can be viewed.

To select channels of the cable box or satellite box

- 1) Turn on this unit by pressing **POWER**. The "POWER" indicator on the front panel will appear. Then, press **CHANNEL** to select channel 3 or 4 (the same channel as the output channel of the cable box or satellite box).
 - If noise appears on the TV screen, press **VIDEO/TV** on the remote control.
 - If you use the channel 4, you will need to change this unit's RF output to channel 4.
 - Refer to "RF converter output" on page I01.
- 2) At the TV, select channel 3 or 4 (the same channel as you have selected at STEP 1)).
- 3) At the cable box or satellite box, select the channel you want to view or record.

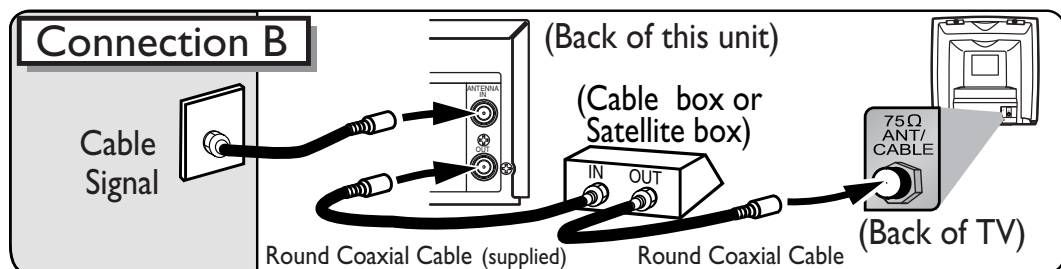

Select this connection when you want to change channels on this unit. With this connection, you may watch one channel while recording another.

- You may not view or record a scrambled channel.

To select channels of the cable box or satellite box

- 1) At the cable box or satellite box, select channel 3 or 4 (the same channel as this unit's RF output channel.)
 - Refer to "RF converter output" on page I01.
- 2) At the TV, select the same channel as the output channel (3 or 4) of the cable box or satellite box.
- 3) Turn on this unit by pressing **POWER**. The "POWER" indicator on the front panel will appear. Then, select the channel you want to view or record.
 - If noise appears on the TV screen, press **VIDEO/TV** on the remote control.

To play back a DVD disc or a videotape

Follow the STEPs 1) to 2) above, to playback a DVD disc or a videotape.

- Refer to "Playback" on pages 47-48, 95.

To view one channel while recording another

- 1) While you are recording on this unit, press **VIDEO/TV**.
- 2) At the cable box or satellite box, select the channel you want to view.

Connections

Connection to an Audio System

- When you change the connections, all devices should be turned off.
- Refer to the operation manual accompanying external devices for more information.

Method 1

Stereo system

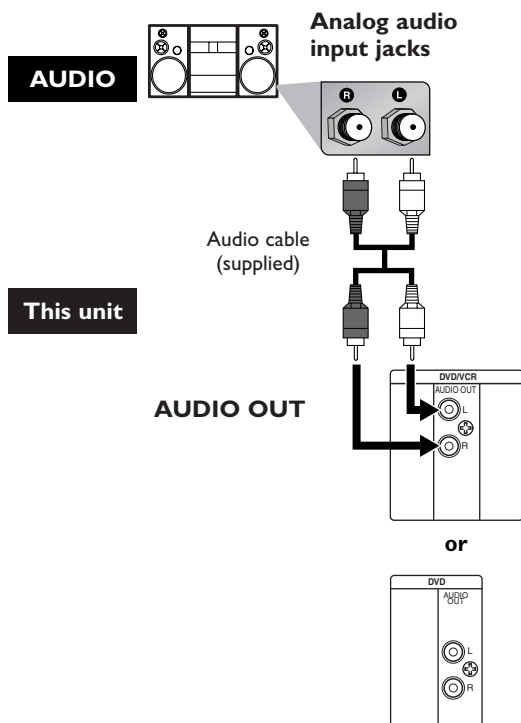

Method 2

Dolby Digital decoder, DTS decoder, MD deck or DAT deck

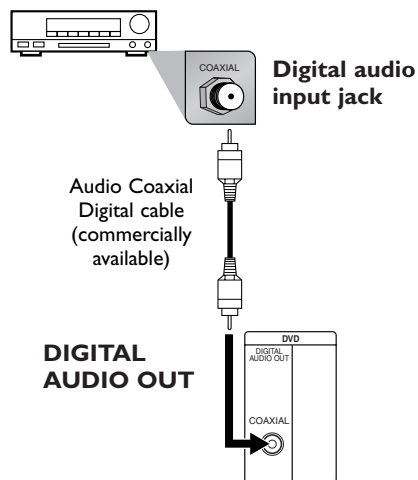

Connection	Setting	SETUP>Advanced Setting Menu >Playback >Digital Out >		
		PCM	Dolby Digital	DTS
If output is Dolby Digital encoded audio, connect to a Dolby Digital decoder.		-	Stream	OFF
If output is DTS encoded audio, connect to the DTS decoder.		-	PCM	ON
If output is encoded audio for both Dolby Digital and DTS, connect to the decoder which encodes multiple audio sources.		-	Stream	ON
Connecting to an MD deck or DAT deck.		-	PCM	OFF
If not connected to any external devices.		-	PCM	OFF

* To complete these settings, refer to pages 91-92.

Note

- By connecting this unit to a Multi-channel Dolby Digital decoder, you can enjoy high-quality Dolby Digital 5.1 channel surround sound as heard in the movie theaters.
- The audio source on a disc in a Dolby Digital 5.1 channel surround format cannot be recorded as digital sound by an MD or DAT deck.
- By connecting this unit to the DTS decoder, you can enjoy 5.1 channel Surround System which reproduces the original sound as truthfully as possible. 5.1 channel Surround System is developed by the Digital Theater System Inc.
- Playing back a DVD using incorrect settings may generate noise distortion and may also damage the speakers.

Getting started

Easy DVD recording

The following will help you to understand easily how to record on DVD discs. Make sure batteries are in the remote control and you have connected this unit and the TV correctly.

Step 1: Choose a disc type

There are several types of recordable DVD discs to choose from. Choose a recordable DVD disc type based on your playback/recording/editing needs. See "DVD disc types" at the bottom of this page for more information on the differences among various compatible media.

This unit can record on the following type of discs.

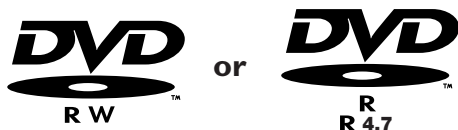

For example, when you want to record repeatedly on the same disc or when you want to edit the disc after recording, select the rewritable DVD-RW type disc.

When you want to save recordings without any alteration, a non-rewritable DVD-R can be your choice.

Step 2: Insert a blank disc

Remote Control

-  **1** Turn on the unit.
-  **2** Select the DVD mode.
-  **3** Open the disc tray.
-  **4** Insert a recordable disc you wish to record.
-  **5** Close the disc tray.

This operation may take a while to be recognized.

DVD disc types

☆☆☆ : Most suitable. ☆☆☆ : Can be used. ☆ : Some functions are limited. — : Cannot be used.

You want to	DVD-RW VR	DVD-RW Video	DVD-R Video
Record TV programs	☆☆☆	☆☆☆	☆☆
Reuse by deleting unwanted contents	☆☆☆	☆☆	—
Edit recorded contents	☆☆☆	☆	☆
Edit/Record from connected equipment	☆☆☆	☆☆☆	☆☆☆
Copy discs for distribution	☆☆ ^{*1}	☆☆☆	☆☆☆
Play on other DVD equipment	☆☆ ^{*1}	☆☆☆	☆☆☆

Features	DVD-RW VR	DVD-RW Video	DVD-R Video
Recording			
Rewritable?	Yes	Yes	No
Can create chapters at fixed intervals (auto.)	Yes	Yes	Yes
Can create chapters wherever you like (manual)	Yes	No	No
Can record 16:9 size pictures	Yes	Yes	Yes
Can record Copy-Once programs	Yes	No	No
Editing			
Can perform basic edit functions	Yes	Yes	Yes
Can perform advanced edit functions (Playlist edit)	Yes	No	No

^{*1} DVD-RW (VR mode) can only be played on DVD equipment that is VR compatible.

Note

For details of the above functions and implied restrictions, see the explanations inside this operation manual.

Format the disc

Insert the disc in the unit. Then, format the disc from the setting menu. Video format (Video mode) or Video recording format (VR mode) will be available depending on the inserted disc type.

Formatting is only necessary to prepare the disc for recording. Details are on pages 28-29.

When you format a disc, the entire contents on that disc will be erased.

- The unit automatically starts formatting when an unused disc is inserted.

Getting started

Easy DVD recording (Cont'd)

Step 3: Select the recording speed

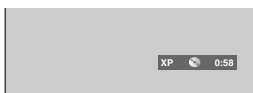
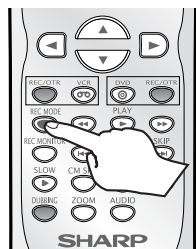

Step 4: Select the desired channel

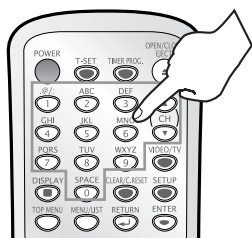

Step 5: Record to DVD discs

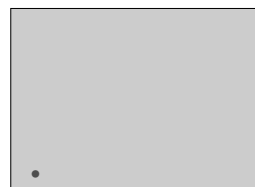
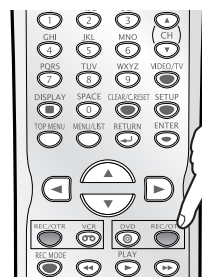

Hint 1: Play back the recorded contents

You can select the title you want to play back from a displayed menu and immediately start playback. Recorded contents are easily accessible, with simple procedure of choosing a title on a chapter on the menu screen.

What are titles and chapters?

The contents of a DVD disc are generally divided into titles. Titles may be further divided into chapters.

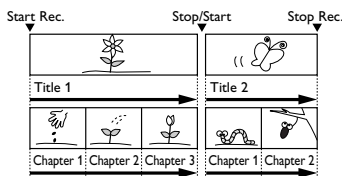

Hint 2: Edit the recorded disc

You will find editing discs is easy. This unit offers convenient editing functions which are possible only with DVD-RW/-R discs.

Title List offers the following editing functions.

- Putting names on titles
 - Setting pictures for thumbnails
 - Setting/clearing chapter markers
 - Deleting parts of titles or scenes
- (Possible editing functions depend on the recording format and editing method.)

Original and Playlist (VR mode)

You can edit the contents on a Playlist without changing the original recordings. A Playlist does not take up much disc space.

What "Original" or "Playlist" is for?

Throughout this operation manual, you will find *Original* and *Playlist* to refer to the original content and the edited version.

- **Original** content refers to what's originally recorded on the disc.
- **Playlist** content refers to the edited version of the original content.

Finalizing a Disc

- You need to record in Video mode and finalize the disc to play it back on other players.
- Once you finalize a disc recorded in Video mode, you cannot record or edit any information on the disc.
- Discs recorded in VR mode can still be edited after finalization.

Step 6: Stop the Record

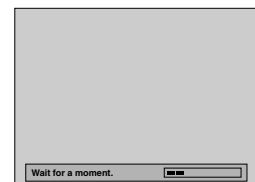
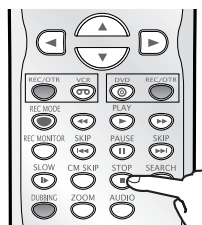

Appears only DVD-RW in VR mode.



This operation may take a while to be completed.

Getting started

Channel setting

Getting channels automatically



Right after the purchase of the unit and whenever you move to a new area, we recommend available channels in your area be stored using "Auto Preset" in the Channel Preset of the setting menu.

1
Press **POWER** to turn on the unit.

2
Turn on the TV and be sure to select the input to which the unit is connected.

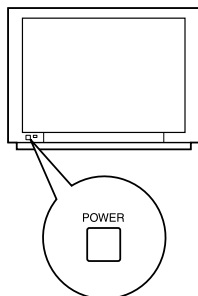

3
Press **SETUP**.
Easy Setting Menu or Advanced Setting Menu will appear.

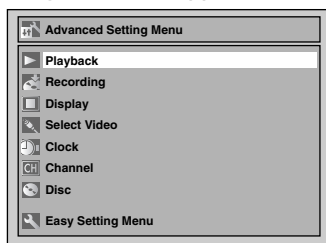

4
Select "Channel" using Cursor \blacktriangle / \blacktriangledown , then press **ENTER**.

Channel menu will appear.

Screen for Advanced Setting Menu:

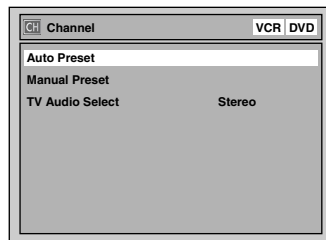

5
Select "Auto Preset" using Cursor \blacktriangle / \blacktriangledown , then press **ENTER**.

The unit will start getting channels available in your area.

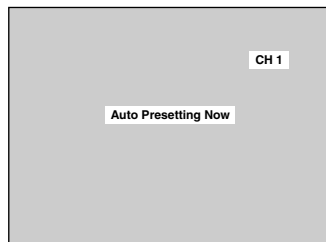

Wait for several minutes to finish channel scanning.

6
Press **SETUP** to exit.

• You can select only the channels memorized in this unit by using **CHANNEL** \blacktriangle / \blacktriangledown on the front panel or **CH** \blacktriangle / \blacktriangledown on the remote control.

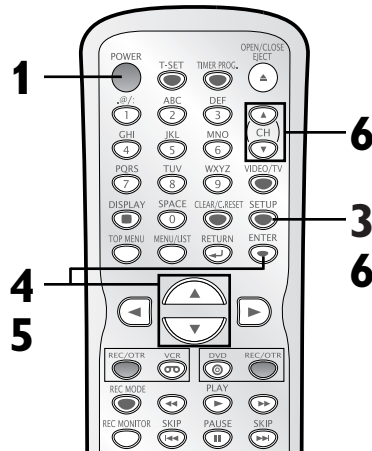

To select a channel

You can select a channel by directly entering channel number using the **Number buttons** on the remote control.

Notes for using the Number buttons:

- When selecting cable channels which are larger than 99, enter channel numbers as a three-digit number (For example: 117, press **1, 1, 7**).
- You must precede single-digit channel numbers with a zero (For example: 02, 03, 04 and so on).
- You can select the line input mode ("L1" or "L2"). To select, press **0, 0, 1**. To select "L2", press **0, 0, 2**. Details are on page 41.

Note

- You cannot change the channel when one of the components of the unit (VCR or DVD) is in the recording, OTR or Timer Recording mode.
- If the auto presetting is canceled during presetting, some of the channels not yet preset may not be received.
- The selection will depend on how you receive the TV channels.

To cancel the auto presetting during scanning:

Press **RETURN** \leftarrow or **SETUP** to cancel.

Getting started

Channel setting (cont'd)

Adding/Deleting channels

The channels you no longer receive or seldom watch can be deleted from the memory. You can also add channels manually into memory.

1

Press SETUP.

Easy Setting Menu or Advanced Setting Menu will appear.

2

Select "Channel" using Cursor ▲ / ▼, then press ENTER.

Channel menu will appear.

Screen for Advanced Setting Menu:

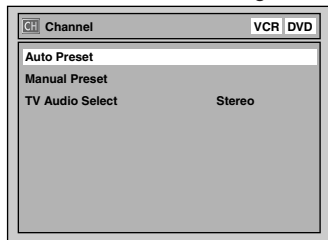

3

Select "Manual Preset" using Cursor ▲ / ▼, then press ENTER.

Manual Preset menu will appear.

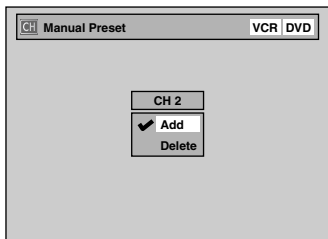

4

Select the channel number to add or delete.

Press **Cursor** ◀ or **CH** ▼ to move to a smaller channel number.

Press **Cursor** ▶ or **CH** ▲ to move to a larger channel number.

• Press **Cursor** ◀ / ▶ to move through the channels one by one, including the ones not in the channel memory, while press **CH** ▲ / ▼ to move through the channels only in the channel memory.

Press the **Number buttons** to select a channel number directly.

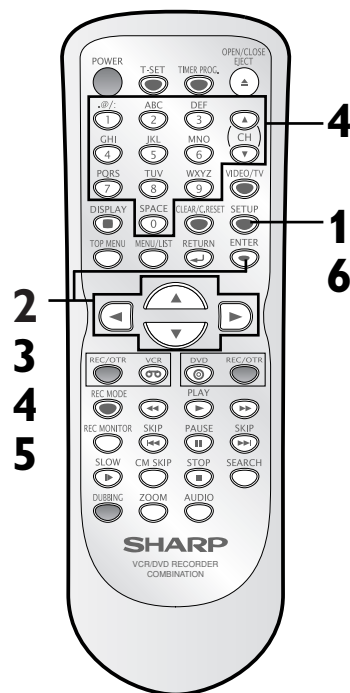

5

Select "Add" or "Delete" using Cursor ▲ / ▼, then press ENTER.

The channel number will be added or deleted from a channel memory. Then the next channel number will appear so that you can continue adding or deleting channels.

6

Press SETUP to exit.

Getting started

Selecting the TV Stereo or SAP

You can select an audio channel to output from TV.

1
Press **SETUP**.

Easy Setting Menu or Advanced Setting Menu will appear. If Advanced Setting Menu is displayed, proceed to STEP 3.

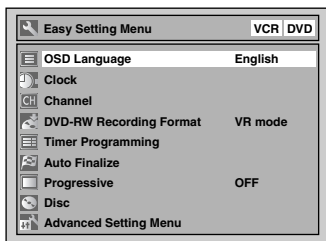

2
Select **“Advanced Setting Menu”** using **Cursor ▲ / ▼**, then press **ENTER**.

Advanced Setting Menu will appear.

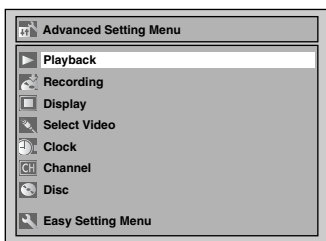

3
Select **“Channel”** using **Cursor ▲ / ▼**, then press **ENTER**.

Channel menu will appear.

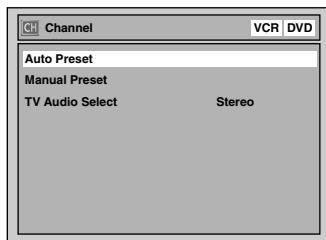

4
Select **“TV Audio Select”** using **Cursor ▲ / ▼**, then press **ENTER**.

Option window will appear.

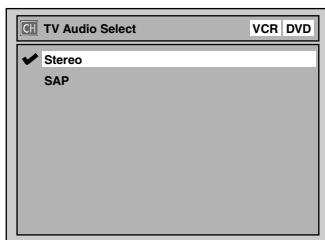

The default is **“Stereo”**.

5
Select **“Stereo”** or **“SAP”** using **Cursor ▲ / ▼**, then press **ENTER**.

Stereo:
Outputs main-audio.
SAP(Secondary Audio Program):
Outputs Sub-audio.

Refer to the item in **“Glossary”** on page 103 for more information.

6
Press **SETUP** to exit.

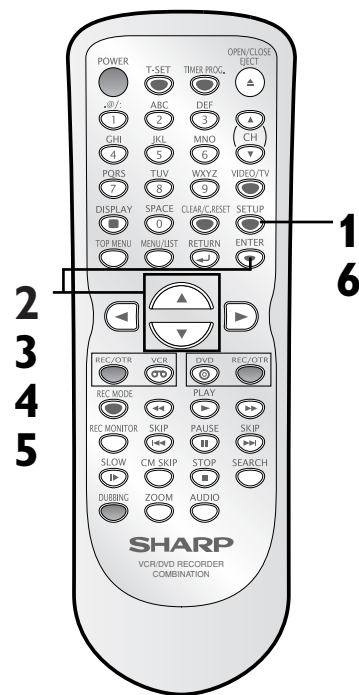

Notes on TV channel audio

- If you want to record a TV program available in second audio or stereo on a DVD-RW/-R or video tape, you have to select either Stereo or SAP in the Channel Preset screen beforehand. Refer to the following table to check an appropriate setting.

Selected audio	Broadcast audio	Disc (Videotape) recording	Audio output
Stereo	STEREO+SAP	STEREO	STEREO
	STEREO	STEREO	STEREO
	MONO+SAP	MONO	MONO
	MONO	MONO	MONO
SAP	STEREO+SAP	SAP	SAP
	STEREO	STEREO	STEREO
	MONO+SAP	SAP	SAP
	MONO	MONO	MONO

- You can only play back the disc in second audio if a TV program is available in second audio and you set **“TV Audio Select”** to **“SAP”**.

Getting started

Setting the clock

Set the correct time before using Timer Recording. If a Public Broadcasting Service (PBS) station is available in your area, follow the Auto Clock Setting below. If not, follow the Manual Clock Setting on pages 23.

Auto Clock Setting

Make sure:

- The antenna/CATV connections are correct.
- If this unit is connected to a Cable Box or Satellite Box, select the local PBS station to set the clock automatically.

1

Press **SETUP**.

Easy Setting Menu or Advanced Setting Menu will appear. If Advanced Setting Menu is displayed, proceed to STEP 3.

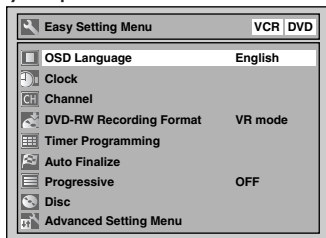

2

Select “Advanced Setting Menu” using Cursor \blacktriangle / \blacktriangledown , then press **ENTER**.

Advanced Setting Menu will appear.

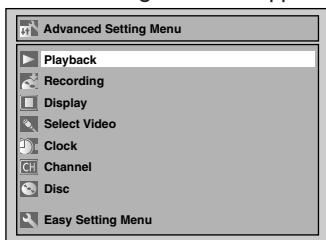

3

Select “Clock” using Cursor \blacktriangle / \blacktriangledown , then press **ENTER**.

Clock menu will appear.

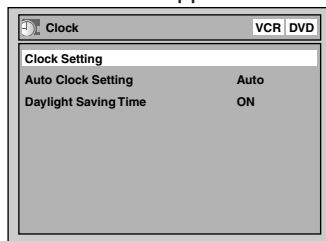

4

Select “Auto Clock Setting” using Cursor \blacktriangle / \blacktriangledown , then press **ENTER**.

Option window will appear.

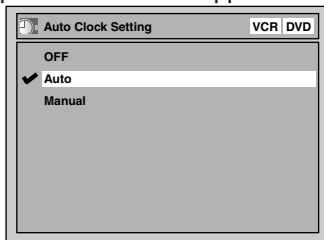

The default is “Auto”.

5

• If you do not know the PBS channel number in your area, select “Auto” using Cursor \blacktriangle / \blacktriangledown , then press **ENTER**.

The setting will be activated.

• If you know the PBS channel number in your area, select “Manual” using Cursor \blacktriangle / \blacktriangledown , then press **ENTER**.

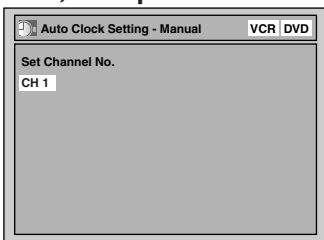

Enter the PBS channel number using the Number buttons or Cursor \blacktriangle / \blacktriangledown , then press **ENTER**.

The setting will be activated.

• If you want to set the clock manually and cancel the auto clock setting function, select “OFF” using Cursor \blacktriangle / \blacktriangledown , then press **ENTER**.

The auto clock setting function will be canceled.

6

Press **SETUP** to exit.

7

Press **POWER** to turn off the unit.

This unit will search for the clock time only when the power is off. Leave it off for several minutes to give this unit time to set the clock on the front display panel.

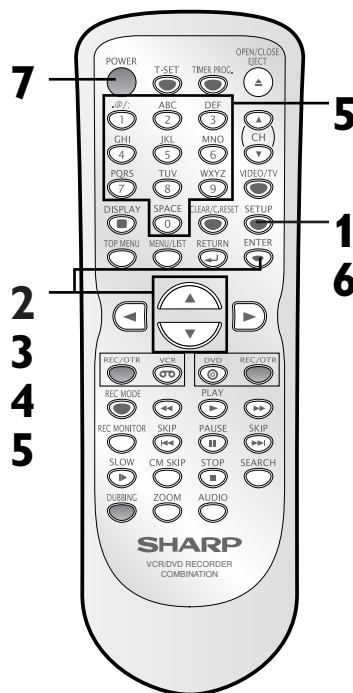

Note

- The clock may set itself automatically after you connect the antenna/CATV signal to this unit and plug in the power cord. In this case, the current time will appear on the front panel display.
- If the current time is not displayed or the displayed clock time is not correct, set the clock manually.

Getting started

Setting the clock (cont'd)

Manual Clock Setting



- 1** Press **SETUP**.
Easy Setting Menu or Advanced Setting Menu will appear.
If Easy Setting Menu is displayed, proceed to STEP 3.

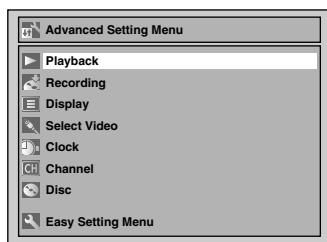

- 2** Select **"Clock"** using **Cursor** \blacktriangle / \blacktriangledown , then press **ENTER**.
Clock menu will appear.

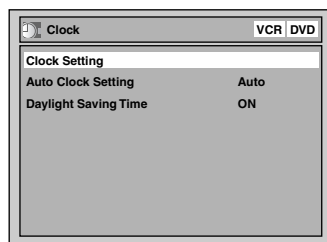

- 3** When entering from Easy Setting Menu, select **"Clock"** using **Cursor** \blacktriangle / \blacktriangledown , then press **ENTER**. When entering from **Advanced Setting Menu**, select **"Clock Setting"** using **Cursor** \blacktriangle / \blacktriangledown , then press **ENTER**.
Clock Setting window will appear.

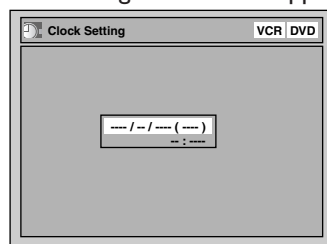

- Press **ENTER** again.
Default date will appear.

- 4** Enter the date (month / day / year) using **Cursor** \blacktriangle / \blacktriangledown .
Press **Cursor** \blacktriangleleft / \blacktriangleright to move the cursor.

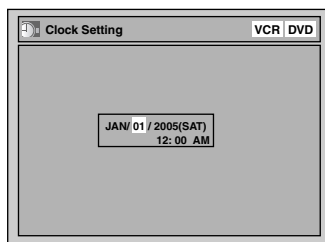

- 5** Enter the time (hour / minute) using **Cursor** \blacktriangle / \blacktriangledown , then press **Cursor** \blacktriangleleft / \blacktriangleright .
A cursor will move on AM or PM.

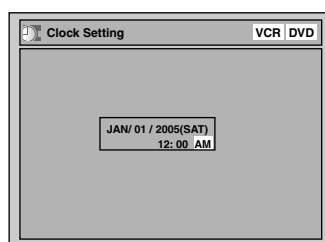

- 6** Press **Cursor** \blacktriangle / \blacktriangledown to select **AM** or **PM**, then press **ENTER**.
Clock menu will appear, then the settings will be activated.
Although seconds are not displayed, they will be counted from zero.

Screen for Advanced Setting Menu:

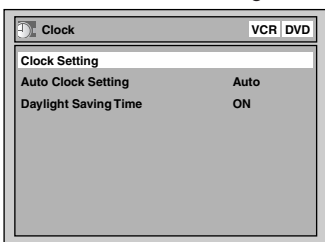

- 7** Press **SETUP** to exit.

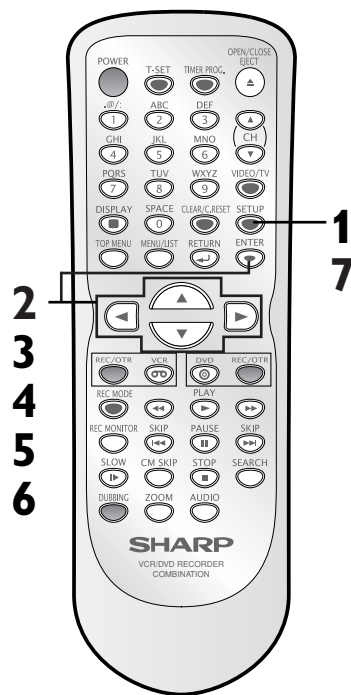

Note

- Your clock setting will be lost if either there is a power failure or this unit has been unplugged for more than 1 minute.

Getting started

Setting the clock (cont'd)

Setting the Daylight Saving Time

When Daylight Saving Time is ON, the unit clock will automatically move forward 1 hour on the first Sunday in April and move back 1 hour on the last Sunday in October.

1
Press **SETUP**.

Easy Setting Menu or Advanced Setting Menu will appear. If Advanced Setting Menu is displayed, proceed to STEP 3.

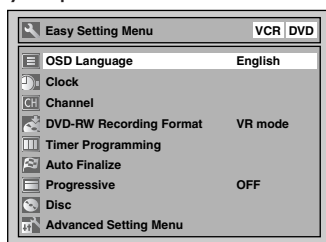

2
Select **“Advanced Setting Menu”** using **Cursor ▲ / ▼**, then press **ENTER**.

Advanced Setting Menu will appear.

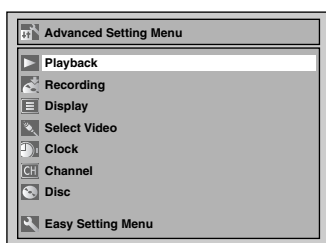

3
Select **“Clock”** using **Cursor ▲ / ▼**, then press **ENTER**.
Clock menu will appear.

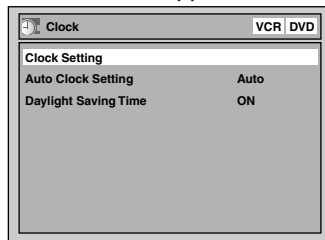

4
Select **“Daylight Saving Time”** using **Cursor ▲ / ▼**, then press **ENTER**.
Option window will appear.

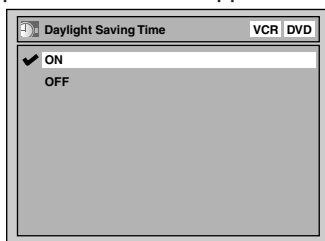

The default is “ON”.

5
Select **“ON”** or **“OFF”** using **Cursor ▲ / ▼**, then press **ENTER**.

Choose “ON” if you are currently observing the daylight saving time.

6
Press **SETUP** to exit.

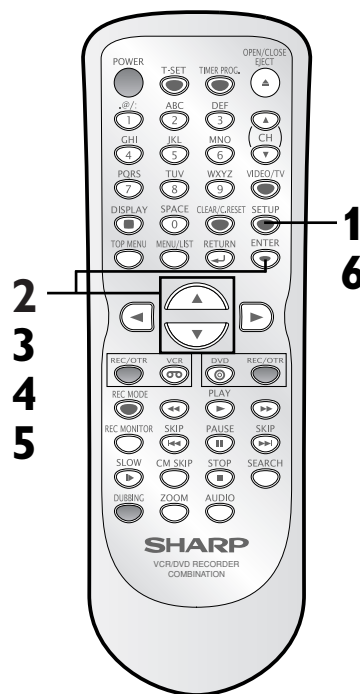

Getting started

Selecting the TV aspect ratio

You can select the TV aspect ratio to match the formats of what you are playing back on the unit and your TV screen (4:3 standard or 16:9 widescreen TV).

1

Press **SETUP**.

Easy Setting Menu or Advanced Setting Menu will appear. If Advanced Setting Menu is displayed, proceed to STEP 3.

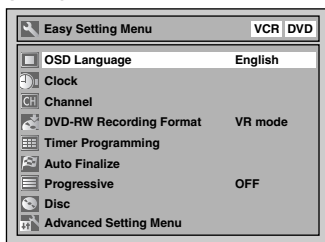

2

Select **“Advanced Setting Menu”** using **Cursor ▲ / ▼**, then press **ENTER**.

Advanced Setting Menu will appear.

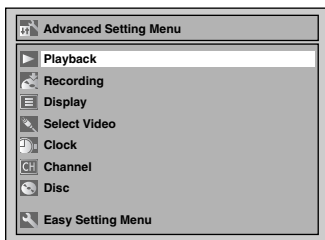

3

Select **“Playback”** using **Cursor ▲ / ▼**, then press **ENTER**.

Playback menu will appear.

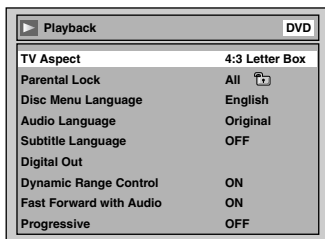

4

Select **“TV Aspect”** using **Cursor ▲ / ▼**, then press **ENTER**.

Option window will appear.

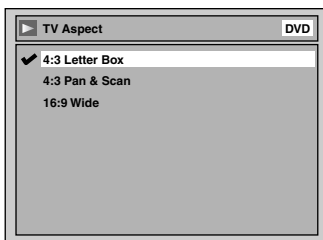

The default is **“4:3 Letter Box”**.

Refer to the **Note** on this page below.

5

Select a desired option using **Cursor ▲ / ▼**, then press **ENTER**.

6

Press **SETUP** to exit.

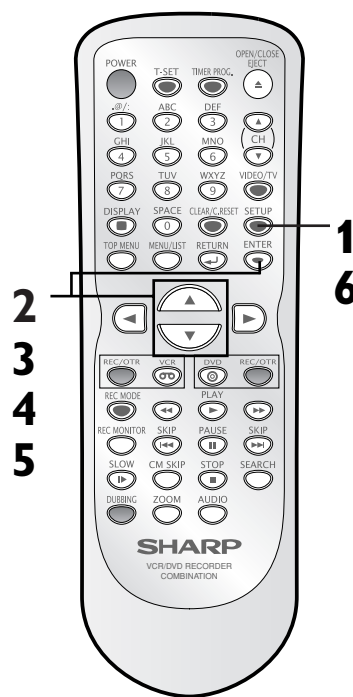

Note

If you have a standard TV:
Select **“4:3 Letter Box”**, for a full length picture with black bars on the top and bottom of the screen. Select **“4:3 Pan & Scan”** for a full height picture with both sides trimmed.



If you have a widescreen TV:
Select **“16:9 Wide”**.

Recording

Information on DVD recording

Information

This unit can record on DVD-RW and DVD-R discs. DVD-RW discs allow you to record programs repeatedly, and the recorded contents can be erased. DVD-R discs allow you to record programs only once, and the recorded contents cannot be erased. You can record programs on DVD-R discs only in Video mode, while recording format for DVD-RW discs can be either Video mode or VR mode.

Logo	Attributes
	8 cm/12 cm, single-sided, single layer disc Approx. max. recording time (SEP mode): 600 minutes (4.7GB) (for 12 cm) 180 minutes (1.4GB) (for 8 cm)
	8 cm/12 cm, single-sided, single layer disc Approx. max. recording time (SEP mode): 600 minutes (4.7GB) (for 12 cm) 180 minutes (1.4GB) (for 8 cm)

Recordable disc





- Discs which can be used with this recorder:
DVD-R: up to 8x (4x disc is recommended)
DVD-RW: 2x and 4x (2x disc is recommended)
- Discs tested and proven to be compatible with this recorder:
MAXELL DVD-R **TDK DVD-RW 2x**
JVC DVD-RW 4x **MITSUBISHI DVD-R 8x**

About Video mode and VR (Video Recording) mode

Video mode is the same recording format as DVD-Video discs purchased locally and played back on most DVD players. To play back the contents recorded in this mode on other DVD players, you will need to finalize them (see page 44). However, you can play back record additional materials or edit discs recorded in Video mode with this unit without finalization.

VR (Video Recording) mode is a basic recording format for DVD-RW. You can record and edit repeatedly.

DVD players with **RW COMPATIBLE** are capable of playing back DVD-RW recorded in VR mode.

Disc type	Disc format	Functions
	 Video mode	Playback, limited recording, limited editing
DVD-RW	 VR mode	Playback, recording, Original/Playlist editing
	 Video mode	Playback, limited recording, limited editing
DVD-R		

Recording speed

You can select a recording speed among 6 options. The recording time will depend on the recording speed you select as follows.

Discs recorded in SLP or SEP on this unit may not be played back on other DVD recorders or DVD players.

Disc Size	Recording speed	Recording time *	Video/Sound Quality
8 cm Disc	XP	18 min	☆☆☆☆☆☆
	SP	36 min	☆☆☆☆☆☆
	LP	72 min	☆☆☆☆
	EP	108 min	☆☆☆
	SLP	144 min	☆☆
	SEP	180 min	☆
12 cm Disc	XP	60 min	☆☆☆☆☆☆
	SP	120 min	☆☆☆☆☆☆
	LP	240 min	☆☆☆☆
	EP	360 min	☆☆☆
	SLP	480 min	☆☆
	SEP	600 min	☆

- The actual recording time may deviate from the time listed above.
- The audio and video quality is getting poorer as the recording time becomes longer.
- Each time **REC MODE** is pressed, recording time will change and be displayed.

Recording

Information on DVD recording (cont'd)





Restrictions on recording

You cannot record copy-protected materials using this unit. Copy-protected materials includes DVD-Video discs and some satellite broadcasts. If copy-protected material is encountered during a recording, recording will be paused or stop automatically and an error message will be displayed on screen.

When recording a TV broadcast or through an external input, you can display copy control information on screen.

Information on copy control

Some satellite broadcasts include copy-protected information. For their recording, refer to the following.

Disc type / format	Copy-free	Copy-once	Copy-prohibited
 ver.1.1, 1.2	☆	—	—
 ver.1.1, 1.2 CPRM compatible	☆	☆	—
 ver.1.1, 1.2	☆	—	—
 ver.1.1, 1.2 CPRM compatible	☆	—	—
 ver.2.0	☆	—	—

☆ Recordable
— Not Recordable

What is “CPRM”?

(Content Protection for Recordable Media)
This is a format used to record copy-once programs. By recording coded data on the area of DVD discs that ordinary writing software cannot write, it prevents copy-once programs from being recorded repeatedly on different media. This unit is CPRM compatible, which means that you can record copy-once broadcast programs, but then you cannot make a copy of those recordings. CPRM recordings can only be made on DVD-RW discs formatted in VR mode, and CPRM recordings can only be played back on players that are compatible with CPRM.

Note

- This recorder cannot record on CD-RW or CD-R discs.
- DVD-RW/-R and CD-RW/-R discs recorded on a personal computer or a DVD or CD recorder may not be played back if the disc is damaged or dirty or if there is dirt or condensation on the player's lens.
- If you record on a disc using a personal computer, there are cases in which it may not be played back because of the settings of the application software used to create the disc even if it is recorded in a compatible format. (Check with the software publisher for more detailed information.)
- Discs recorded in Video mode on this unit cannot record any additional materials using other DVD recorders.
- A DVD-RW disc formatted with this unit cannot be used on other DVD recorders.
- Since the recording is made by the variable bit rate (VBR) method, the actual remaining time for recording may be a little bit shorter than the remaining time displayed on the OSD depending on the picture you are recording.

Making discs playable on other DVD player (Finalize)

After recording, you must finalize disc in order to play back on any other unit. (Refer to page 44.)

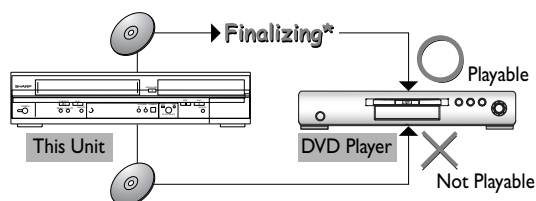

* You cannot finalize discs in other DVD recorders.

After finalizing:

- Once DVD-RW/-R (Video mode) is finalized, you cannot record additional materials or edit.
- You can record additional materials on or edit the finalized DVD-RW (VR mode).
- When DVD-RW/-R (Video mode) is finalized, title menu will be created automatically.

Finalize discs recorded on this unit in order to play them back on other DVD players.

Recording

Formatting a disc

Choosing the recording format of a blank disc



When inserting a blank disc, the unit starts to initialize it automatically.

After that, you can record on the disc with a recording format selected in the setting menu.

1



Press **SETUP**.

Easy Setting Menu or Advanced Setting Menu will appear.

If Easy Setting Menu is displayed, proceed to STEP 3.

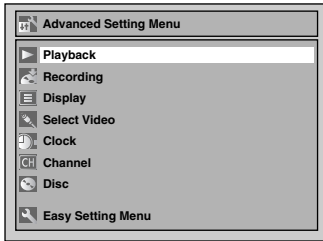

2

Select **“Recording”** using **Cursor ▲ / ▼**, then press **ENTER**.

Recording menu will appear.

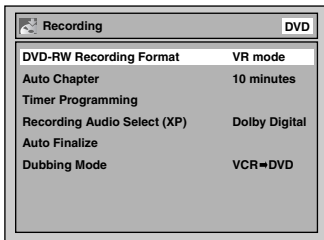

3

Select **“DVD-RW Recording Format”** using **Cursor ▲ / ▼**, then press **ENTER**.

Option window will appear.

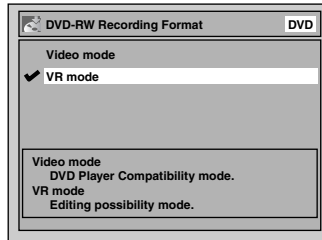

The default is **“VR mode”**.

4

Select **“Video mode”** or **“VR mode”** using **Cursor ▲ / ▼**, then press **ENTER**.

The recording mode will be set.

5

Press **SETUP** to exit.

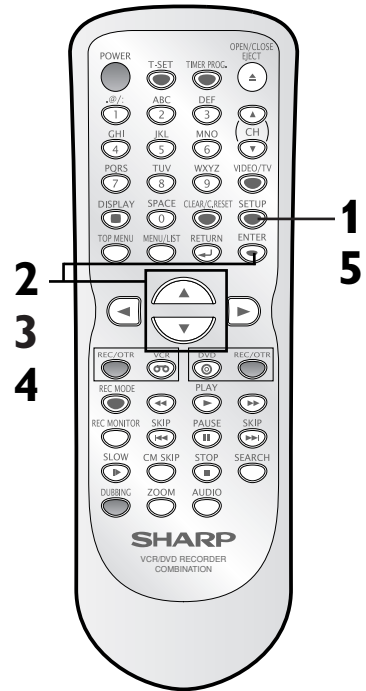

Note

- The recording format setting is effective only for DVD-RW discs. You cannot change the recording format for a DVD-R disc. DVD-R discs will always be in Video mode.
- **You cannot mix two formats on one DVD-RW disc. When you load a disc once recorded before, the recording format cannot be changed even if you change it in the setting menu.**
- When inserting a blank DVD+RW or DVD+R disc, the error message (“Disc Error”) will appear. **This unit is not compatible with a DVD+RW/+R disc for recording.**
- Playlist will be created automatically when recording on DVD-RW in VR mode.

Recording

Formatting a disc (cont'd)

Reformatting a disc



VR mode is the default recording format for DVD-RW. You can change it to Video mode from the setting menu.

1

Press **SETUP**.

Easy Setting Menu or Advanced Setting Menu will appear.

2

Select **"Disc"** using **Cursor ▲ / ▼**, then press **ENTER**.

Disc menu will appear.

Screen for VR mode Disc menu:

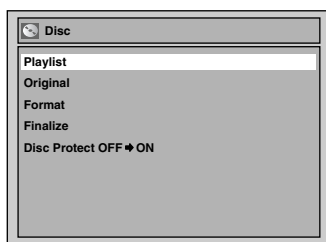

3

Select **"Format"** using **Cursor ▲ / ▼**, then press **ENTER**.

Confirmation window will appear.

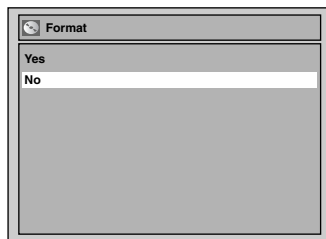

4

Select **"Yes"** using **Cursor ▲ / ▼**, then press **ENTER**.

Final confirmation window will appear.

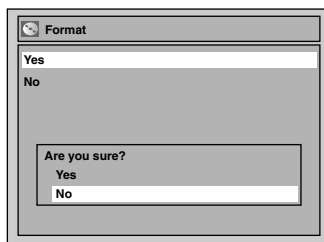

5

Select **"Yes"** using **Cursor ▲ / ▼**, then press **ENTER**.

Formatting will start.

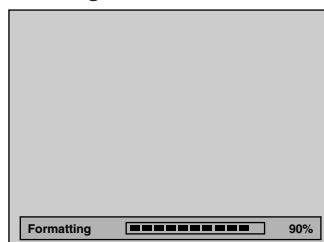

6

Formatting is complete.

"100%" will be indicated.

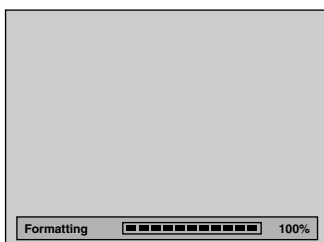

This operation may take a while to be completed.

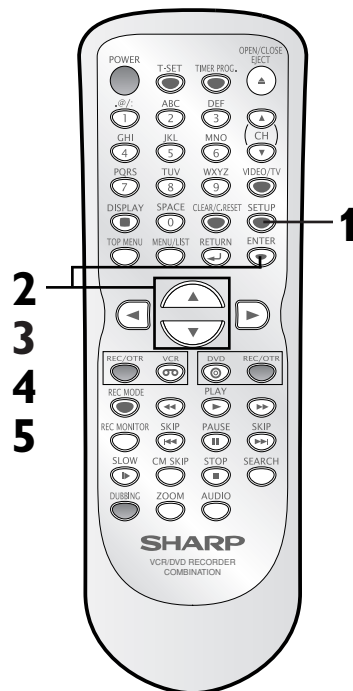

Note

- When you reformat the disc, all contents of the disc will be erased.
- If you want to cancel reformatting at STEP 4 or 5, select "No".
- A disc once formatted with this unit cannot be used on other DVD recorders.

Recording

Auto Chapter



You can set specific time interval for chapter marks.

1

Press **SETUP**.

Easy Setting Menu or Advanced Setting Menu will appear. If Advanced Setting Menu is displayed, proceed to STEP 3.

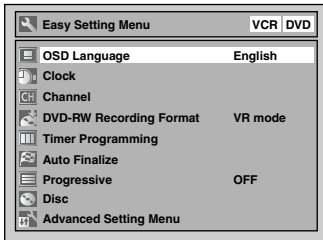

2

Select “Advanced Setting Menu” using **Cursor ▲ / ▼**, then press **ENTER**.

Advanced Setting Menu will appear.

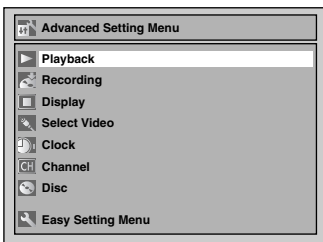

3

Select “Recording” using **Cursor ▲ / ▼**, then press **ENTER**.

Recording menu will appear.

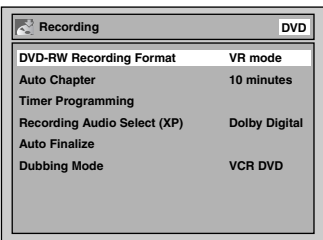

4

Select “Auto Chapter” using **Cursor ▲ / ▼**, then press **ENTER**.

Option window will appear.

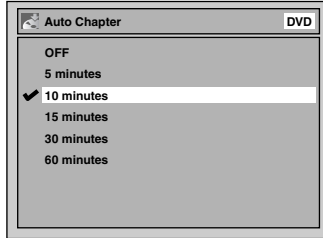

The default is “10 minutes”.

5

Select a desired time option using **Cursor ▲ / ▼**, then press **ENTER**.

Chapter marks will be put as you specified.

6

Press **SETUP** to exit.

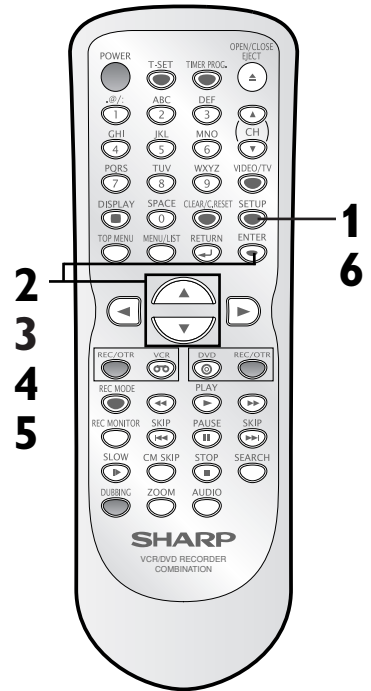

Note

- The interval for auto chapter marks may slightly deviate from the one you specified on the Auto chapter screen in Video mode.
- A blank chapter may be created depending on the remaining time of the disc.

Recording

Recording Audio Select (XP)



You can enjoy high quality sound recording. This function works only when the recording speed is set at XP.

1

Press SETUP.

Easy Setting Menu or Advanced Setting Menu will appear. If Advanced Setting Menu is displayed, proceed to STEP 3.

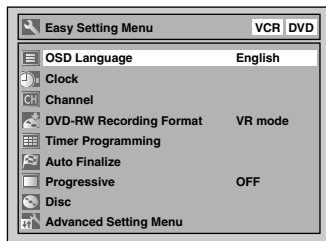

2

Select “Advanced Setting Menu” using Cursor ▲ / ▼, then press ENTER.

Advanced Setting Menu will appear.

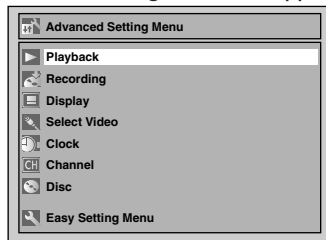

3

Select “Recording” using Cursor ▲ / ▼, then press ENTER.

Recording menu will appear.

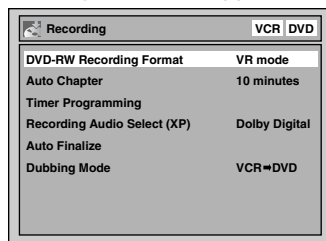

4

Select “Recording Audio Select (XP)” using Cursor ▲ / ▼, then press ENTER.

Option window will appear.

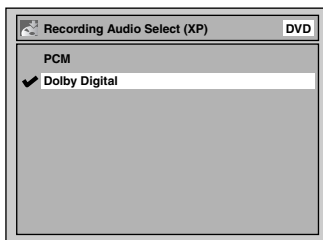

The default is “Dolby Digital”.

5

Select “PCM” or “Dolby Digital” using Cursor ▲ / ▼, then press ENTER.

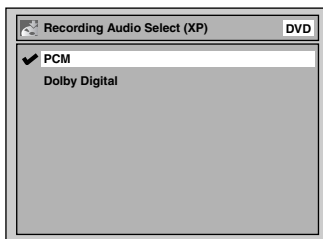

PCM:

Records PCM audio for the best quality sound.

Dolby Digital:

Records Dolby Digital audio for good quality sound.

6

Press SETUP to exit.

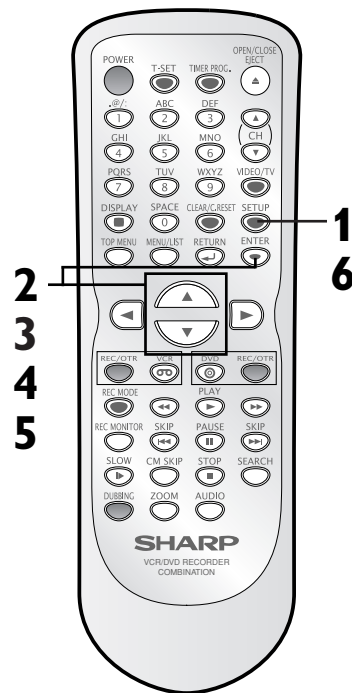

Note

- “PCM” stands for Pulse Code Modulation. It changes analog sound to digital sound without compressing audio data.
- When the recording speed is set at other than XP, the unit records “Dolby Digital” audio automatically even if you selected “PCM”.

Recording

Basic recording



Follow steps below to record TV programs.

press first.

1

Turn on the unit and load a recordable disc.

Make sure that the TV input is set on the unit.

This operation may take a while to be recognized.

2

Select a recording speed using REC MODE.



Refer to "Recording speed" on page 26.

3

Make sure that the recording format is set to the desired mode.

Refer to "Formatting a disc" on pages 28-29.

When a DVD-RW disc is loaded:

You can choose Video mode or VR mode from the setting menu. The default is "VR mode". Refer to "Choosing the recording format of a blank disc" on page 28.

When a DVD-R disc is loaded:

DVD-R discs will be always in Video mode.

4

Select a desired channel to record using CH ▲ / ▼ or the Number buttons.



5

Press REC/OTR to start recording.

"●" mark will be displayed for 5 seconds.

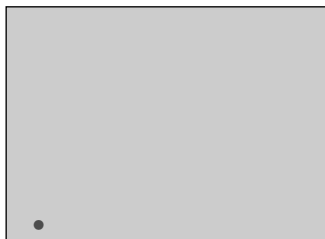

To pause the recording, press **PAUSE II**. Press **REC/OTR** or **PAUSE II** to restart the recording.

6

Press STOP ■ to stop the recording.

This operation may take a while to be completed.

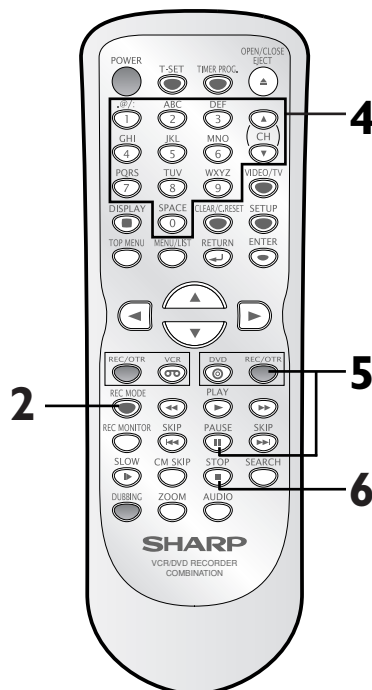

Note

- Recording starts immediately after you press **REC/OTR** and continues until the disc is full or you stop recording.
- When the clock setting has not been made, the space for a date and time of title names in the Original or Playlist will be blank.
- When you record a TV program broadcasted in both Stereo and SAP audio on a DVD-RW/-R, you have to select the TV channel audio (Stereo or SAP) beforehand. Only the selected channel audio will be recorded. Refer to "Selecting the TV Stereo or SAP" on page 21 for more details.
- **You cannot mix two formats on one DVD-RW disc.**
When you load a disc once recorded before, the recording format cannot be changed even if you change it in the setting menu.
- You cannot change the recording speed during the REC pause mode.
- You can change channels during the REC pause mode.

Recording

Basic recording (cont'd)

Checking the recording picture and sound quality



You can confirm the recording picture and the sound quality for the recording speed you have selected before attempting to record on a DVD disc.



1

While the unit is in stop mode or recording mode with a DVD disc to record inserted, press **REC MONITOR**.

The TV program will be on the screen in the same picture and sound quality as it will be for the recording speed you have selected.



If you want to change the recording speed, press **REC MODE** repeatedly.

The recording speed will be changed as you press the button as shown below. Refer to "Recording speed" on page 26.

- You cannot change the recording speed during recording.

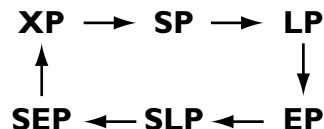

2

Press **REC MONITOR** again to exit.

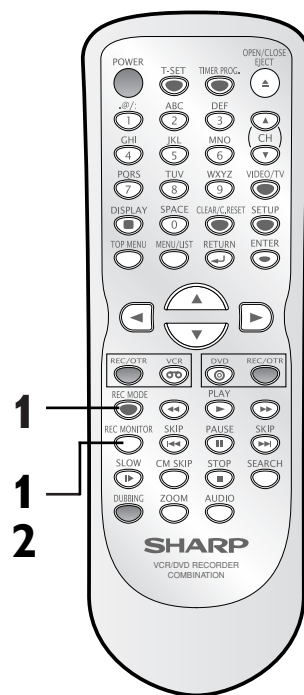

Note

- If you press **REC MONITOR** while receiving the bilingual broadcast, the sound to be recorded is output.

Recording

One-touch Timer Recording



This is a simple way to set the recording time in blocks of 30 minutes. Check that the disc has enough recordable space for the time you set.

After finishing the recording, the recorder automatically goes into standby.



1
Turn on the unit and load a recordable disc.

Make sure that the TV input is set on the unit.

This operation may take a while to be recognized.

2
Select a recording speed using **REC MODE**. Refer to "Recording speed" on page 26.

3
Make sure that the recording format is set to the desired mode. Refer to "Formatting a disc" on pages 28-29.

When a DVD-RW disc is loaded:
You can choose Video mode or VR mode from the setting menu. The default is "VR mode". Refer to "Choosing the recording format of a blank disc" on page 28.

When a DVD-R disc is loaded:
DVD-R discs will always be in Video mode.

4
Select a desired channel to record using **CH ▲ / ▼** or the **Number** buttons.

5
Press **REC/OTR**, then press **REC/OTR** repeatedly to select a desired recording time.

Recording time appears on the TV screen (30 minutes to 8 hours). Recording will start.

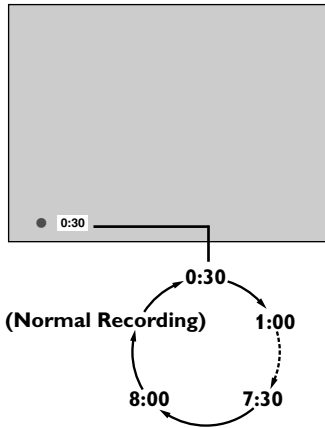

When the unit reaches the specified time, it will be turned off automatically.

To change the recording time during the One-touch Timer Recording, press **REC/OTR** repeatedly until the desired time appear.

To cancel the One-touch Timer Recording within the specified time, press **STOP ■**.

This operation may take a while to be completed.

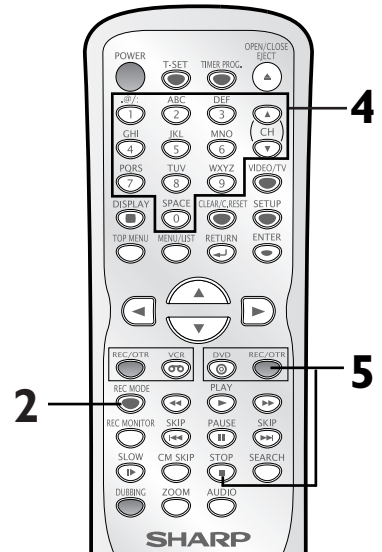

Note

- The remaining recording time will appear on the display panel during an One-touch Timer Recording. Press **DISPLAY** to see it on the TV screen.
- You cannot pause a One-touch Timer Recording.
- Unlike a Timer Recording, you can perform the following operations during a One-touch Timer Recording.
 - Turning off the power.
 - Using **REC/OTR, STOP ■**.
- The unit will be turned off automatically under the following conditions.
 - 1) No space remained on the disc.
 - 2) When a power failure occurs.
- If OTR is finished in DVD during playback or REC mode in VCR, the DVD will be in stop mode and the VCR keeps the current mode.
- When OTR is finished and the power is turned off, the unit will switch to the standby mode automatically if a Timer Recording has been programmed. Press **T-SET** to cancel the standby mode for using the unit continuously.

Recording

Timer Recording



You can program the unit to record up to 8 programs, within a month in advance. Daily or weekly program recordings are also available.

- Be sure to set the clock before programming a timer recording.
- Insert a recordable disc or a videotape with an erase-protection tab.

1 SKIP 2

Press **SETUP**.

Easy Setting Menu or Advanced Setting Menu will appear. If Easy Setting Menu is displayed, proceed to STEP 3.

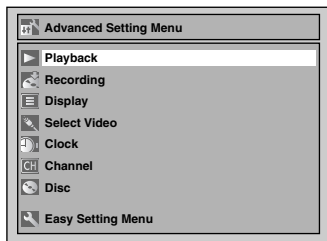

2

Select "Recording" using **Cursor ▲ / ▼**, then press **ENTER**.

Recording menu will appear.

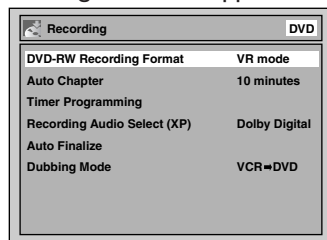

3

Select "Timer Programming" using **Cursor ▲ / ▼**, then press **ENTER**.

Timer Programming list will appear.

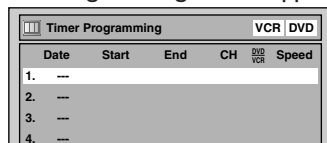

4

Select the program which is not set up using **Cursor ▲ / ▼**, then press **ENTER**.

5

Enter a date or a routine option for **Timer Programming** using **Cursor ▲ / ▼**.

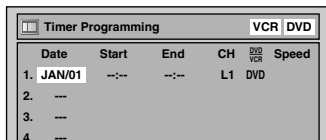

e.g. January 1st

Cursor ▲ changes date. **Cursor ▼** will give you routine option as described.

6

Enter the time to start and to end using **Cursor ▲ / ▼**, then press **Cursor ►**.

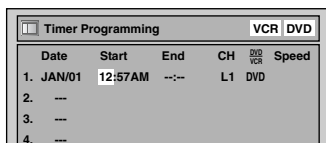

7

Select the channel number to record using **Cursor ▲ / ▼**, then press **Cursor ►**.

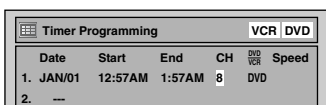

To record from external input, select L1 or L2.

8

Select a recording media using **Cursor ▲ / ▼**, then press **ENTER**.

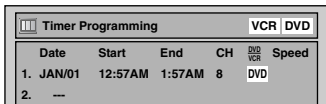

You can choose the timer programming menu by pressing **TIMER PROG**. In this case, continue with STEP 4.

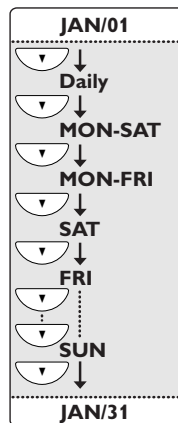
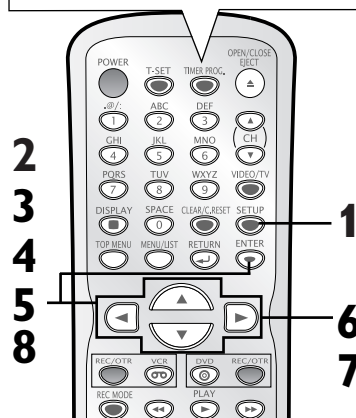

Note

- If you have not set the clock yet: A clock setting window will appear after STEP 3. Continue with the STEP 3 in "Auto Clock Setting" on page 22 or "Manual Clock Setting" on page 23 before setting a timer programming.
- Press **Cursor ◀ / ▶** on move the cursor to the left and the right on the timer programming menu.

Recording

Timer Recording (cont'd)

9

Select a recording speed using Cursor \blacktriangle / \blacktriangledown .

Timer Programming						VCR	DVD
Date	Start	End	CH	$\frac{DVD}{VCR}$	Speed		
1. JAN01	12:57AM	1:57AM	8	DVD	SP		
2.	---						

Refer to "Recording speed" on page 26. If you choose Auto, the unit automatically selects the best recording speed to make the best quality picture according to the remaining disc space.

- This function works only on the Program 1 in the DVD recording.
- The recording may be cut short, when the available recording space of the disc is too limited.

10

Press **ENTER** when all information required is entered.

- Your program setting will be stored.
- To set another program, repeat STEPS 4 to 10.
 - To exit, press **TIMER PROG.** or **SETUP**.
 - When programs are overlapped, "Overlap" and the overlapped program number will appear on the display.

11

Press **T-SET** to turn off.

- The unit will be set in the timer standby mode. Ⓢ indicator will appear on the front display.
- Also the DVD or VCR indicates in the display window which you set.



- After this step, the available functions for the other component will be limited to a playback and basic recording. You can not use **SETUP** or change output mode under such conditions.

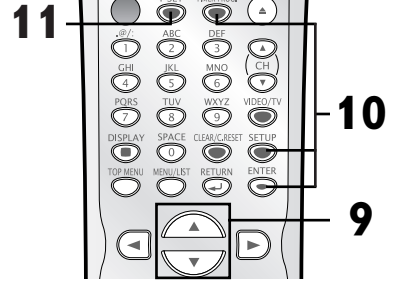

Canceling, or correcting the timer programming information during the timer standby mode

1

Press **T-SET** so that Ⓢ indicator disappears from the front display.

2

Press **TIMER PROG.** Timer Programming list will appear.

Timer Programming						VCR	DVD
Date	Start	End	CH	$\frac{DVD}{VCR}$	Speed		
1. JAN01	12:57AM	1:57AM	8	DVD	SP		
2.	---						

3

Check the information on the list you will need.

4

To clear the timer programming, select the program using Cursor \blacktriangle / \blacktriangledown . Then, press **CLEAR/C.RESET**.

To correct the timer programming, select the program using Cursor \blacktriangle / \blacktriangledown . Then, press **ENTER**. Next, correct the timer programming by using Cursor \blacktriangle / \blacktriangledown / \blackleftarrow / \blackrightarrow . Finally, press **ENTER** again.

5

Press **TIMER PROG.** to exit.

6

Press **T-SET** to return to the timer standby mode.

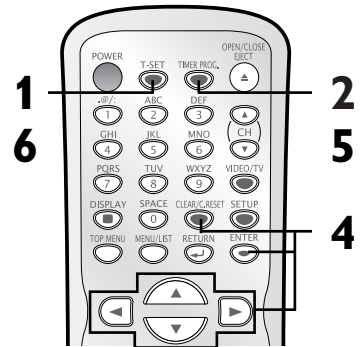

Note

- To confirm the timer programming, press **POWER** first and then **TIME PROG.** when the unit is in timer standby mode. Or, press **TIME PROG.** while using the side of the unit that is free from Timer Recording (either DVD or VCR). You cannot select any programs for correction or add new programs while the unit is in timer standby mode.
- When all the Timer Recording is completed, the Ⓢ indicator flashes. To play or eject the recorded disc (or the videotape), press **T-SET** or **POWER** first and then press **PLAY** \blacktriangleright or **OPEN/CLOSE** \blacktriangle (or **STOP/EJECT** \blacksquare / \blacktriangle).
- The unit will be turned on automatically before the recording time.

To stop the Timer Recording in progress

Press **STOP** \blacksquare to stop the disc recording or **STOP/EJECT** \blacksquare / \blacktriangle to stop the videotape recording on the front panel of the main unit. **STOP** \blacksquare on the remote control is not effective.

Recording

Timer Recording (cont'd)

If the timer program did not complete correctly, the error number appears on the timer programming list.

Date	Start	End	CH	Disc	Speed
* JAN/01	12:57AM	1:57AM	8	DVD	E22
2.	---	---	---	---	---
3.	---	---	---	---	---

Error number will appear

Each error number means:

E1-22	Recording error other than below	E36	Already finalized Video format disc
E23-24	Unrecordable disc	E40	Some portion has not been recorded because of program overlapping. Recording did not start at the start time. No videotape is inserted. Videotape ran out during recording.
E25-28	Copy prohibited program		
E29	Disc protected		
E30	Disc full		
E31-32	Already 99 titles recorded		
E33	Already 999 chapters recorded		
E34	No space for Control information	E41	Power failed
E35	PCA full		
		E42	No disc when recording

Note

- A program with the error number is highlighted in gray of the asterisked line in the timer programming list.
- Once the timer programming list with error indication is displayed, the program line(s) with error will be cleared only after the programs are canceled and reset to the timer standby mode.
- The current recording program will be highlighted in red.

Explanation on the front panel indicator during Timer Recording

<p>(CLOCK) mark</p>	Lights off	<ul style="list-style-type: none"> - An OTR is completed, and there is no other timer recordings in standby. - The timer standby mode is cancelled by pressing T-SET. - POWER is pressed during timer standby, and the component that is not in timer standby mode is turned on.
	Lights on	<ul style="list-style-type: none"> - The unit entered into the timer standby mode. - A Timer Recording or an OTR has started. - When this indicator is on, you cannot use SET UP.
	Flashing	<ul style="list-style-type: none"> - All timer recordings are completed.
<p>VCR mark</p>	Lights off	<ul style="list-style-type: none"> - All VCR Timer Recordings are completed, and there is no other timer recordings in standby. - A VCR Timer Recording is cancelled by pressing STOP/EJECT on the unit. - The VCR timer standby mode is cancelled by pressing T-SET. - POWER is pressed during VCR timer standby, and the unit switched to the DVD mode.
	Lights on	<ul style="list-style-type: none"> - The VCR entered into the timer standby mode.
	Flashing	<ul style="list-style-type: none"> - The VCR entered into the timer standby mode when no tape or a tape without an erase protection tap is in the unit. - The tape runs out during Timer Recording.
<p>DVD mark</p>	Lights off	<ul style="list-style-type: none"> - All DVD Timer Recordings are completed, and there is no other timer recordings in standby. - The DVD timer standby mode is cancelled by pressing T-SET.only momentarily. - POWER is pressed during DVD timer standby, and the unit switched to the VCR mode.
	Lights on	<ul style="list-style-type: none"> - The DVD entered into the timer standby mode.
	Flashing	<ul style="list-style-type: none"> - The DVD entered into the timer standby mode when no disc or an unrecordable disc is in the unit. - The disc runs out of the space during Timer Recording.

Note

- If the end of programmed time in DVD and a start of programmed time in VCR are the same, the indicator of the front panel may not be switched from DVD to VCR automatically. However, the Timer Recording for VCR is in progress normally. In such case, press **OUTPUT SELECT** on the front panel or **VCR** on the remote control to activate the display. This is not a malfunction.



Recording

Timer recording (cont'd)

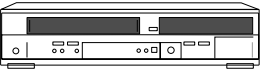
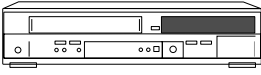
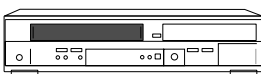
Notes on Timer Recording

<p>Both DVD and VCR</p> 	<ul style="list-style-type: none"> • If there is a power failure or the unit has been unplugged for more than 1 minute, the clock setting and all timer settings will be lost. • If a programmed start and end time are the same, the recording will be set for 24 hours automatically. • If a start time is earlier and an end time is later than the current time, the recording will start right after you press T-SET.
<p>DVD</p> 	<ul style="list-style-type: none"> • If a disc becomes full during timer recording, the unit turns itself off. In such case, press T-SET. Insert a new disc. And then press T-SET again to resume the timer recording.
<p>VCR</p> 	<ul style="list-style-type: none"> • If a tape reaches the end during timer recording, the unit automatically ejects the tape. In such case, insert a new tape to resume the timer recording.

Limited Functions during Timer Recording

Timer Recording is in Standby	
<p>Cancelling the Timer standby mode.</p>	<ul style="list-style-type: none"> • Press T-SET.
<p>Both DVD and VCR</p> 	<ul style="list-style-type: none"> • You cannot use any functions for either component (even after a timer recording on one component has already began).
<p>Either DVD or VCR</p>  <p>OR</p> 	<ul style="list-style-type: none"> • You cannot change output mode or use SETUP while the other component is in timer standby. • You can turn on the side of the unit that is not in timer standby by pressing POWER, however you cannot use SETUP or change output mode. You only can play or make a basic recording while the other component is in timer standby.

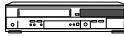
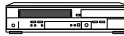
Timer Recording is in progress	
<p>Cancelling the Timer Recording.</p>	<ul style="list-style-type: none"> • Press STOP ■ on the front panel of the Timer Recording side (VCR or DVD).
<p>Both DVD and VCR</p> 	<ul style="list-style-type: none"> • The timer recording cannot be performed in DVD and VCR at the same time. If you make two programmings with the same channel and time in both components, the program with a lower program number will be recorded.
<p>Either DVD or VCR</p> <p>OR</p>  	<ul style="list-style-type: none"> • You cannot change channels.

Other Situations

<ul style="list-style-type: none"> • If a basic recording or an OTR is in progress on one component (e.g.VCR) and the timer recording set for the other component (e.g. DVD) is about to begin, the unit automatically switches to the programmed channel 2 minutes before the programmed starting time, and the recording in progress (for VCR) will be cancelled UNLESS their recording channels are the same. If their recording channels are the same, the timer recording (for DVD) will start without cancelling the recording currently in progress (on the VCR). In this case, a recording of the same channel will be made on both DVD and VCR.

Timer recording (cont'd)

Hints for Timer Recording

The priority of overlapped settings

This unit prioritizes recording as follows if the timer programmings are overlapped.
A Timer Recording of lower priority will be canceled, start from the middle or stop on the way.
Check the overlapped timer programmings and change the priority if necessary.

■ A programming set first has priority

- When the starting time is same:
A program with a lower program number (PROG. 1) has priority.

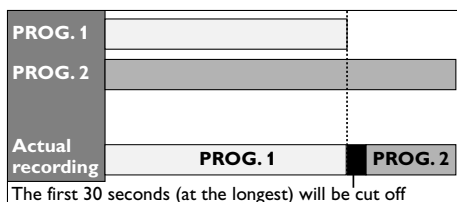

- When some programmings have been made around the ending time of the program currently being recorded:
A program with a lower program number (PROG. 2) has priority.

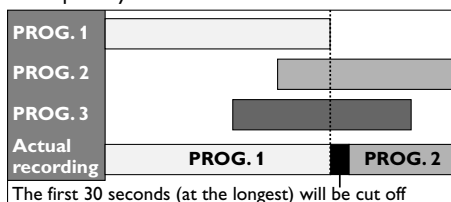

- When the recording time is partially overlapped:
PROG. 1 will start after PROG. 2 is completed.

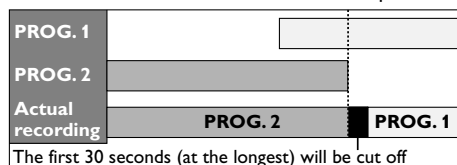

- When the recording time is entirely overlapped:
PROG. 1 will not be recorded.

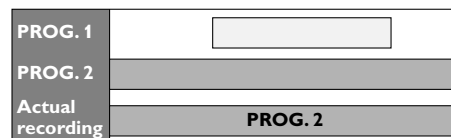

Note for DVD recording

- When the recording time of two programs are overlapped, or the ending time of a program and the starting time of another is same, the first 30 seconds (at the longest) of the subsequent program will be cut off.
- If the cut-off portion reaches 1 minute or more, this program will be displayed with error number E40 on the Timer Programming list.

- When the ending time of the programming currently being recorded and the starting time of the subsequent program are same:
If PROG. 1 is recorded on a DVD, the beginning of the PROG. 2 may be cut off.
The amount of time cut off differs depending on the recording media. For example, if both PROG. 1 and PROG. 2 are recorded on a DVD, the first 30 seconds (at the longest) of PROG. 2 will be cut off.

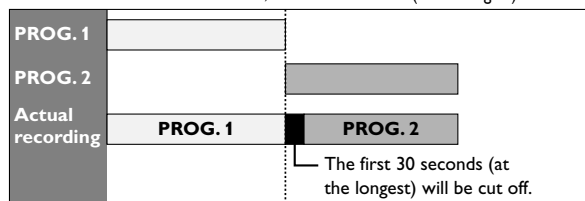

Recording

Settings for an external source

Connection to an external source



Connect the external source properly to the unit by using input jacks either LINE2 (Front) or LINE1 (Rear). When connecting an external equipment of monaural output to this unit, use AUDIO L jack of LINE1 (Rear) or LINE2 (Front).

Use commercially available S-Video or Video cable and an Audio cable for this type of connection.

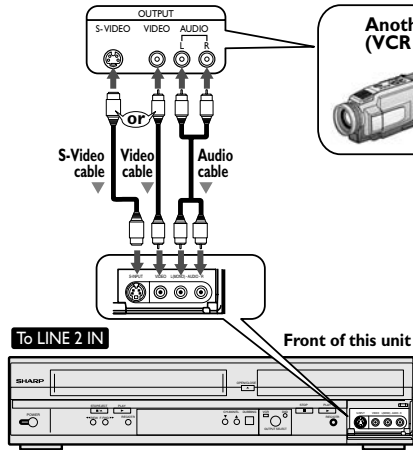

1. Press **SETUP**.

Easy Setting Menu or Advanced Setting Menu will appear. If Advanced Setting Menu is displayed, proceed to STEP 3.

2. Select “Advanced Setting Menu” using **Cursor ▲ / ▼**, then press **ENTER**.

Advanced Setting Menu will appear.

3. Select “Select Video” using **Cursor ▲ / ▼**, then press **ENTER**.

Select Video menu will appear.

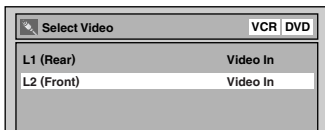

4. Select “L2 (Front)” using **Cursor ▲ / ▼**, then press **ENTER**.

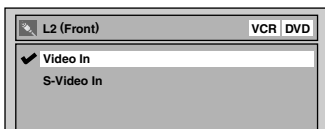

5. Select the input jack type to connect using **Cursor ▲ / ▼**, then press **ENTER**.

If you want to use S-VIDEO INPUT, select “S-Video In”. If you want to use VIDEO INPUT (Composite), select “Video In”.

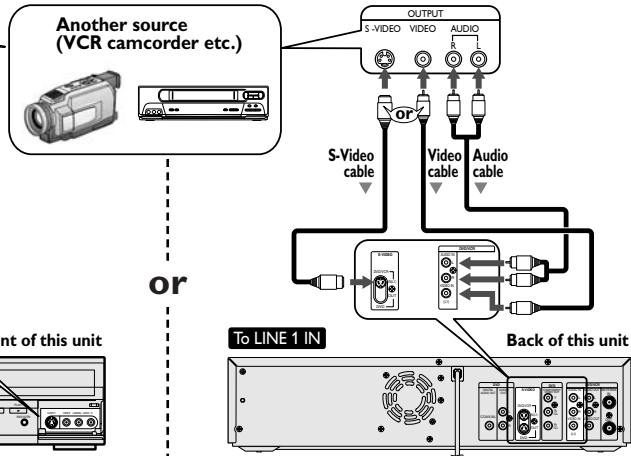
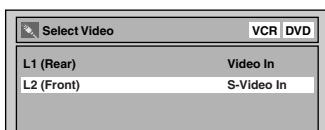

1. Press **SETUP**.

Easy Setting Menu or Advanced Setting Menu will appear. If Advanced Setting Menu is displayed, proceed to STEP 3.

2. Select “Advanced Setting Menu” using **Cursor ▲ / ▼**, then press **ENTER**.

Advanced Setting Menu will appear.

3. Select “Select Video” using **Cursor ▲ / ▼**, then press **ENTER**.

Select Video menu will appear.

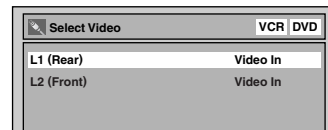

4. Select “L1 (Rear)” using **Cursor ▲ / ▼**, then press **ENTER**.

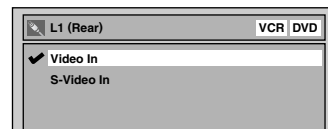

5. Select the input jack type to connect using **Cursor ▲ / ▼**, then press **ENTER**.

If you want to use S-VIDEO INPUT, select “S-Video In”. If you want to use VIDEO INPUT (Composite), select “Video In”.

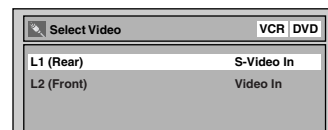

Recording

Settings for an external source (cont'd)

Recording from an external source



Before recording from an external source, see the instructions for the connection on page 40.

1. Turn on the TV and the unit, and be sure to select the input of the TV to which the unit is connected.

2. When you want to record to the disc: press first.

Press OPEN/CLOSE EJECT to open the disc tray, then place the disc to record.

3. Press OPEN/CLOSE EJECT to close the disc tray.

This operation may take a while to be recognized.

When you want to record to a videotape: press first.

Insert the videotape with an erase-protection tab into the cassette compartment.

4. Select the input of the unit which the external equipment is connected (L2 or L1).

- To use the input jacks on the back of this unit, select "L1" position by pressing 0, 0, 1 on the remote control or CH / .
- To use the input jacks on the front of this unit, select "L2" position by pressing 0, 0, 2 on the remote control or CH / .

5. Select a recording speed by using REC MODE. Refer to "Recording speed" on page 26 for DVD or page 95 for VCR.

DVD mode XP → SP → LP → EP → SLP → SEP VCR mode SP ↔ SLP

6. Press REC/OTR to start recording.

7. Press Play on the external source to record from.

8. For disc: Press STOP to stop recording.

This operation may take a while to be completed.

For videotape: Press STOP/EJECT on the unit to stop recording.

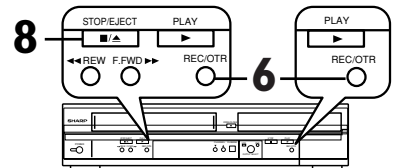
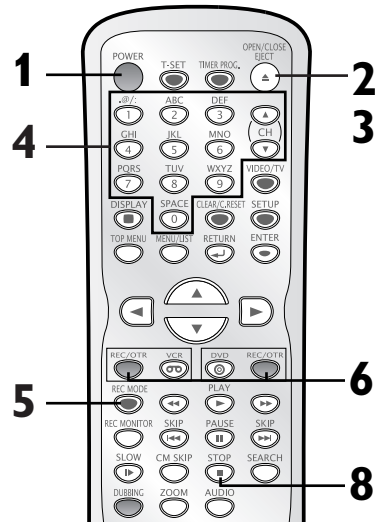

Setting a disc to protect



To prevent accidental recording, editing or erasing of the titles, you can protect them from Disc menu.

1

Press **SETUP**.

Easy Setting Menu or Advanced Setting Menu will appear.

2

Select "Disc" using Cursor / , then press **ENTER**.

Disc menu will appear.

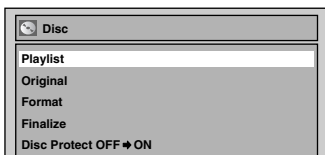

3

Select "Disc Protect OFF → ON" using Cursor / , then press **ENTER**.

Option window will appear.

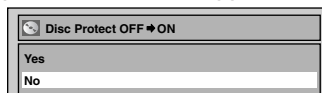

4

Select "Yes" using Cursor / , then press **ENTER**.

The disc will be protected.



This operation may take a while to be completed.

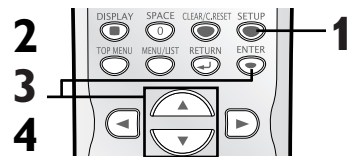

Note

- The Disc Protect setting is available only for a DVD-RW disc recorded in VR mode.
- You can select only Disc Protect off when a protected disc is inserted.

To cancel the disc protect:

- When you insert a protected disc in this unit, "Disc Protect ON → OFF" will appear.

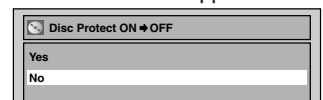

To cancel the protection setting for the disc, select "Disc Protect ON → OFF" at STEP 3, then select "Yes".

Recording

Dubbing Mode



You can copy a DVD disc to a videotape or copy a videotape to a DVD disc. This function will be possible only if the DVD disc or the videotape is not copy protected. Before starting this function, prepare for the recording on the DVD-RW/-R disc or the videotape. Refer to pages 32-33, 95.

Make sure:

- Insert a recordable disc and a videotape with an erase-protection tab.

Note for recording to a videotape:

- The videotape's erase-protection tab is intact.
- The remaining time of the videotape is long enough.

Note for recording to a disc:

- Make sure that the disc is recordable. Refer to pages 26-27.

1

Press **SETUP** to display setting menu.

Easy Setting Menu or Advanced Setting Menu will appear. If Advanced Setting Menu is displayed, proceed to STEP 3.

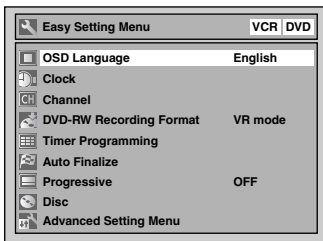

2

Select “Advanced Setting Menu” using **Cursor ▲ / ▼**, then press **ENTER**.

Advanced Setting Menu will appear.

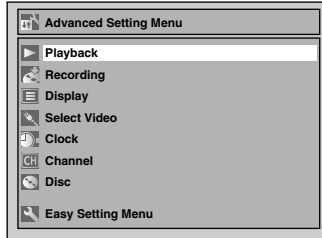

3

Select “Recording” using **Cursor ▲ / ▼**, then press **ENTER**.

Recording menu will appear.

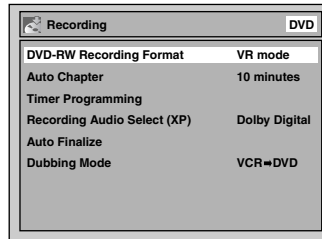

4

Select “Dubbing Mode” using **Cursor ▲ / ▼**, then press **ENTER**.

Option window will appear.

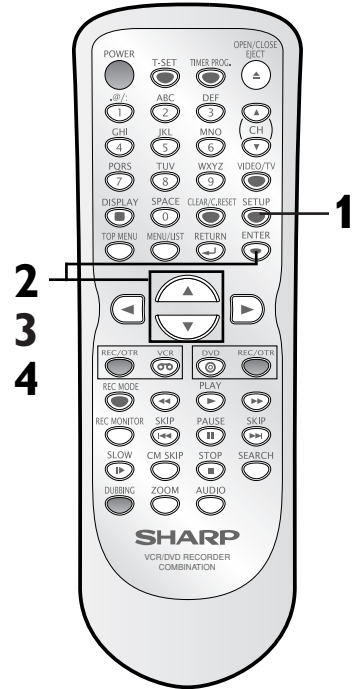
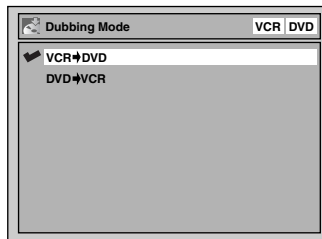

Note

For VCR to DVD duplication:

- After starting VCR to DVD duplication, the picture may be distorted because of the auto tracking function. This is not a malfunction. Be advised to play back the videotape until the picture is stabilized, then set the starting point which you wish to start recording, and start VCR to DVD duplication.

Recording

Dubbing Mode (cont'd)

VCR to DVD

5-a

Select "VCR → DVD" using Cursor ▲ / ▼, then press ENTER.

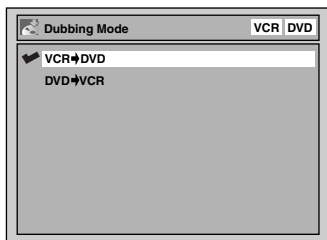

6-a

Press **SETUP** to exit Setting menu.



Select a recording speed using **REC MODE**.

7-a



Press **PLAY** ► on the unit, and then press **PAUSE** ■■ at the point you wish to start recording.

- Since it takes about a few seconds before the actual dubbing begins, please allow extra 5 seconds when selecting the starting point.

8-a

Press **DUBBING**.
VCR to DVD duplication will start.

9-a

Press **STOP** ■ on the unit or **STOP** ■ on the remote control to stop the recording.

DVD to VCR

5-b

Select "DVD → VCR" using Cursor ▲ / ▼, then press ENTER.

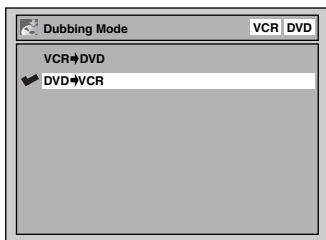

6-b

Press **SETUP** to exit Setting menu.



Select a recording speed using **REC MODE**.

7-b



Press **PLAY** ► on the unit, and then press **PAUSE** ■■ at the point you wish to start recording.

8-b

Press **DUBBING**.
DVD to VCR duplication will start.

9-b

Press **STOP/EJECT** ■/▲ on the unit or **STOP** ■ on the remote control to stop the recording.

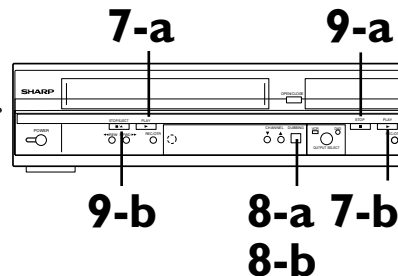
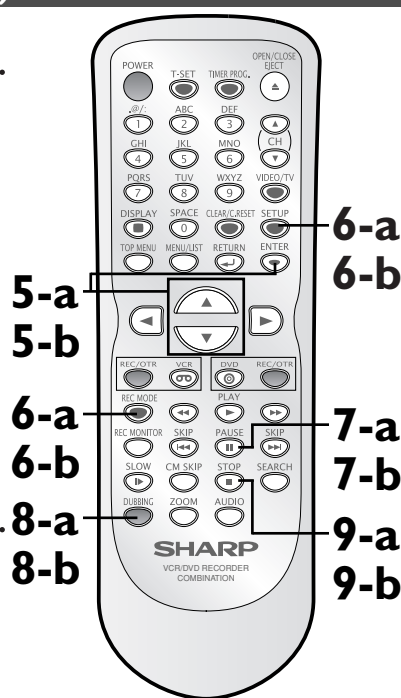

Note

- When you turn off the unit after setting the Dubbing Mode to **DVD → VCR**, the setting will be set to **VCR → DVD** automatically.
 - Dubbing Mode is available only if the videotape or disc is not copy protected.
 - You cannot change the output mode during VCR to DVD or DVD to VCR duplication.
- For DVD to VCR duplication:**
- Only the Audio CDs can be copied to a videotape. You cannot copy MP3 files to a videotape.
- For VCR to DVD duplication:**
- The playback sound mode is followed by the setting of VCR playback sound mode on page 97. Set the playback sound mode to which you wish to record to the DVD.

Recording

Finalizing the discs



You will need to finalize the discs recorded in Video mode to play them back on other DVD players. Finalizing may take several minutes up to an hour. (It can take up to 15 minutes for a disc recorded in Video mode and 60 minutes for a disc recorded in VR mode.) A shorter recording period on the disc will require a longer time period for finalization. Do not unplug the power cord during finalization. Details are on pages 26-27.

1

Press **SETUP**.

Easy Setting Menu or Advanced Setting Menu will appear.

2

Select “Disc” using Cursor \blacktriangle / \blacktriangledown , then press **ENTER**.

Disc menu will appear.

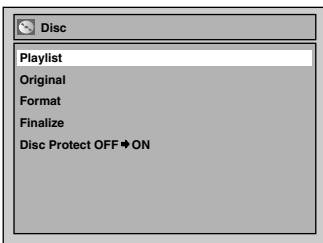

3

Select “Finalize” using Cursor \blacktriangle / \blacktriangledown , then press **ENTER**.

Confirmation window will appear.

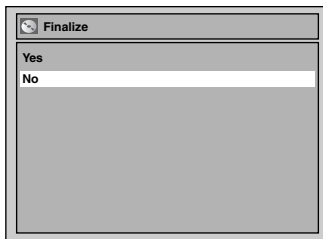

4

Select “Yes” using Cursor \blacktriangle / \blacktriangledown , then press **ENTER**.

Finalizing will start.



To cancel finalizing... (DVD-RW only)

- To cancel finalizing at STEP 4, press **STOP** \blacksquare , select “YES”, then press **ENTER**. Finalizing is canceled and the unit will be in stop mode.

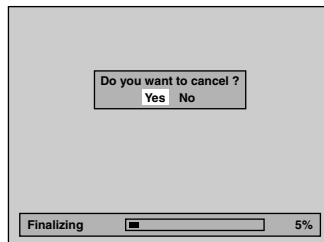

- If \odot appear when pressing **STOP** \blacksquare , you cannot cancel finalizing because the finalizing has progressed to a certain point.
- When selecting “No” and press **ENTER** or **RETURN** \leftarrow , finalizing will be continued.
- You cannot cancel finalizing the DVD-R disc once it has started.

This operation may take a while to be completed.

5

Finalizing is complete.

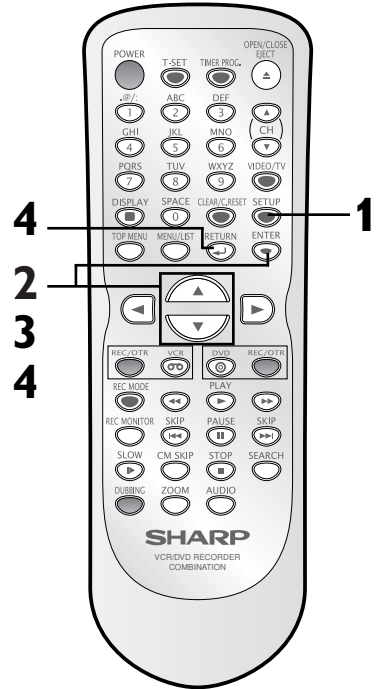
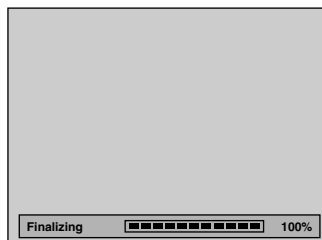

Note

- Finalizing discs in Video mode automatically creates title menus.
- Once you have finalized a disc recorded in Video mode, you can not edit or record anything else on that disc. Discs recorded in VR mode can still be recorded and edited on this unit even after finalization.
- When you insert a DVD-RW disc finalized with this unit, “Undo Finalize” will appear instead of “Finalize”.

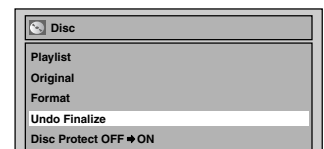

To reverse the finalization of the disc, select “Undo Finalize” at STEP 3.

* **DO NOT** power off during finalization. This will result in malfunction.

Auto finalize



You can finalize discs automatically using Auto Finalize function. This function automatically finalizes discs after all Timer Recordings are completed or when the disc space runs out. This function is available only for DVD-RW/-R recorded in Video mode.

1



Press **SETUP**.

Easy Setting Menu or Advanced Setting Menu will appear. If Easy Menu is displayed, proceed to STEP 3.

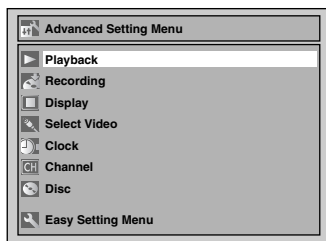

2

Select **“Recording”** using Cursor **▲ / ▼**, then press **ENTER**.

Recording menu will appear.

3

Select **“Auto Finalize”** using Cursor **▲ / ▼**, then press **ENTER**.

Option window will appear.

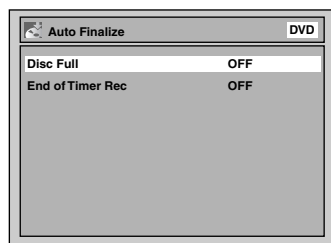

4

Select **“Disc Full”** or **“End of Timer Rec”** using Cursor

▲ / ▼, then press **ENTER**.

Option window will appear.

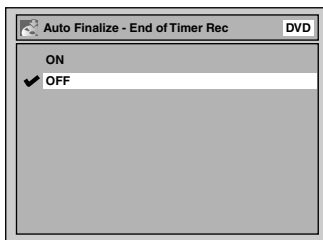
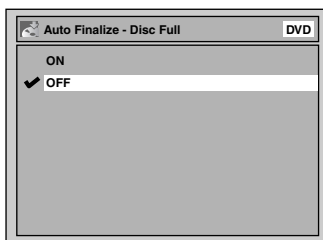

5

Select **“ON”** using Cursor

▲ / ▼, then press **ENTER**.

Your setting will be activated.

6

Press **SETUP** to exit.

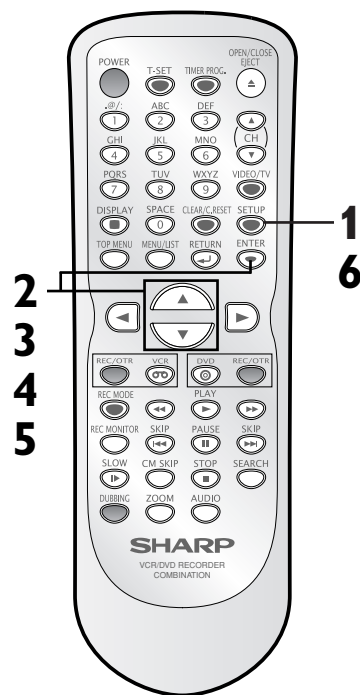

Note

- Auto Finalize function is not available for discs recorded in VR mode.

Disc Playback

Information on DVD playback

Before you attempt to play back DVD discs, read the following information.

Playable discs

This unit is compatible with the following discs. To play back a DVD, make sure that it meets the requirements for Region Codes and Color Systems as described below. Discs with the following logos can be played back on the unit. Other Disc types are not guaranteed to be played back.

Disc	Logo
DVD VIDEO	
DVD-RW (VIDEO/VR mode)	
DVD-R (VIDEO mode)	
*DVD+RW	
*DVD+R	
CD-DA (AUDIO CD)	
CD-RW (CD-DA FORMAT, MP3 files)	
CD-R (CD-DA FORMAT, MP3 files)	

* Some DVD+RW/+R discs may not be operated properly because the unit conforms to the discs recorded in DVD-RW/-R format.

Color systems

DVDs are recorded in different color systems throughout the world. The most common color system is NTSC (which is used primarily in the United States and Canada). This unit uses NTSC. You must use DVDs recorded in the NTSC system. You cannot play back DVDs recorded in other color systems.

Region codes

This unit has been designed to play back DVD discs with Region One (1). DVDs must be labeled for ALL regions or for Region 1. You cannot play back DVDs labeled for other regions. Look for the symbols below on your DVDs. If these region symbols are not on your DVD, you cannot play back the DVD on this unit. The number inside the globe refers to region of the world. A DVD labeled for a specific region can only be played back on a DVD recorder with the same region code.



Hints for DVD playback

The contents of DVD disc are generally divided into titles. Titles may be further subdivided into chapters.

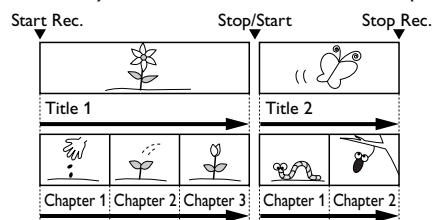

Guide to displays

press first.

Press **DISPLAY** to call up the display menu. This menu will give you the information on the disc currently played back. Some operations are available during disc playback.



- Indicates a disc type and a format mode.
Note: In some descriptions on this manual, only one disc type is indicated as an example.
- Indicates a current channel number and an audio status of the program.
- Indicates a recording speed and possible recording time left.
- Indicates a title number, chapter number, and the time elapsed of disc playback.
- Each icon means:
 - : Search
 - : Audio
 - : Subtitle
 - : Angle (except VR mode)
 - : Repeat
 - : Marker
 - : Noise Reduction
 - : Zoom
- Indicates current disc status.

Note

- This is an example screen only for explanation. Displayed items are depending on the actual mode.

Disc Playback

Basic playback

Playback



1

Press **POWER** on the remote control or the front panel of the unit.

When you are playing back a DVD, turn on the TV and be sure to select the input to which the unit is connected.

2

Press **OPEN/CLOSE EJECT** ▲ to open the disc tray. The disc tray will open.

3

Place the disc on the disc tray with its label facing up and make sure to align the disc to the disc tray guide.

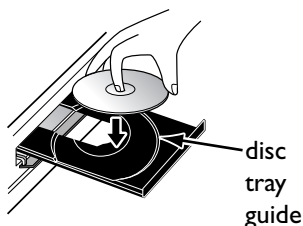

4

Press **OPEN/CLOSE EJECT** ▲ to close the disc tray.

The unit may take a while to recognize the disc type.

5

Press **TOP MENU** to display the title menu.

You can change "Original" or "Playlist" of VR mode using **MENU/LIST**.

Screen for DVD-RW/-R in Video mode:

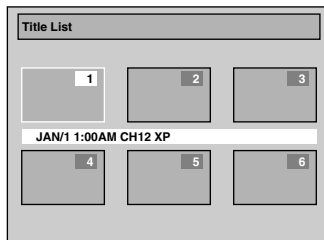

Screen for DVD-RW in VR mode:

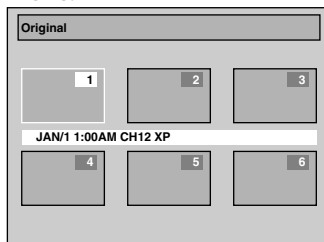

↕ **MENU/LIST** button

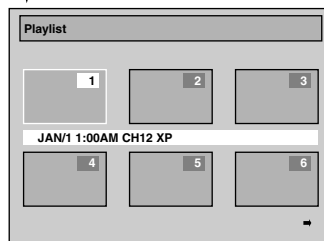

6

Select a desired title using **Cursor** ▲ / ▼ / ◀ / ▶, then press **ENTER**. Playback will start.

7

Press **STOP** ■ to stop playback.

To eject the disc, press **OPEN/CLOSE EJECT** ▲ to open the disc tray, then remove the disc before turning off the unit.

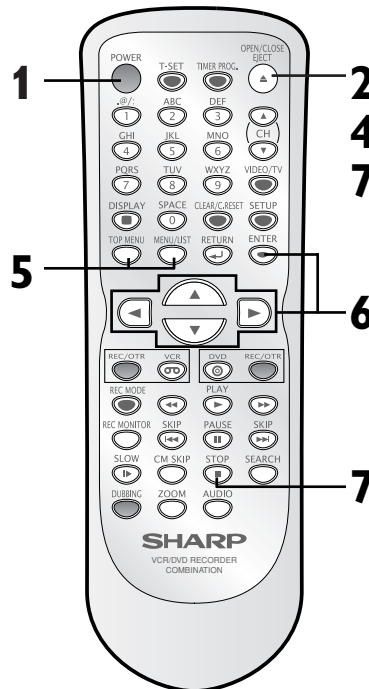

Note

- For DVD-RW (Video mode), DVD-R (Video mode), and DVD+R discs which are already finalized and DVD+RW discs, a Title Menu will be displayed instead of thumbnails.

Screen for the Disc finalized on this unit:

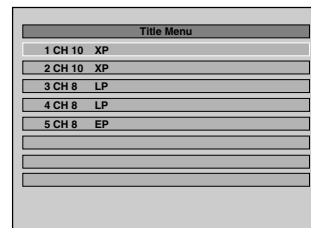

- You can resume playback from the point you stopped playback (Resume playback). Refer to page 51 for details about resume playback.
- Some discs may start playback automatically.

Disc Playback

Basic playback (cont'd)



press first.

1

Press **POWER** on the remote control or the front panel of the unit.

When you are playing back a DVD, turn on the TV and be sure to select the input to which the unit is connected.

2

Press **OPEN/CLOSE EJECT** to open the disc tray. The disc tray will open.

3

Place the disc on the disc tray with its label facing up and make sure to align the disc to the disc tray guide.

4

Press **PLAY** to start playback. Playback will start.

If you are playing back a DVD-Video, a menu may appear. Refer to page 49 for details about a disc menu.

5

Press **STOP** to stop playback.

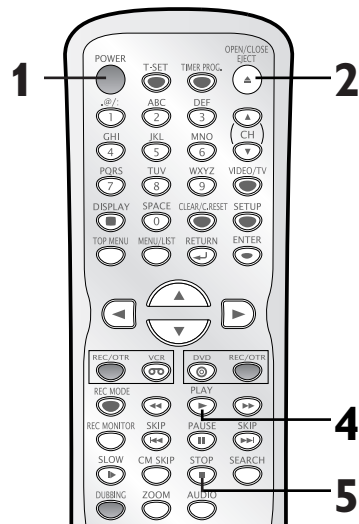

Note

- Some discs may start playback or bring up the File List automatically.

For MP3 playback

1

In stop mode, press **TOP MENU** to call up the File List.

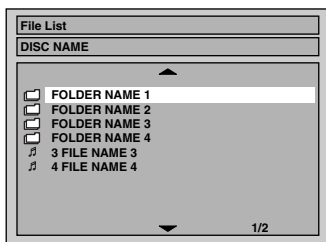

- To exit the File List, press **TOP MENU** again.

2

Press **Cursor** to select a desired folder (group) or track, then press **ENTER**.

When selecting track:

Playback will start.

When selecting the folder:

The files in folder will appear.

Press **Cursor** to select the track or file you want, then press **ENTER**.

- Press **PLAY** , **ENTER** or **Cursor** to move to the lower hierarchies.
- Press **Cursor** or **RETURN** to move back to the previous hierarchy.
- Press **STOP** to return to the first item.

Hints for MP3 files:

- Folders are known as Groups, files are known as Tracks.
- Folders are accompanied by icon.
- MP3 files are accompanied by icon. Playback will start from the selected track and go to the next one in turn.
- The unit can recognize up to 255 groups (or folders) and tracks.
- The name of group and track can be displayed in up to 29 characters. Unrecognizable characters will be replaced with asterisks.
- If there are no files in the folder, "No Files" will be displayed.
- For MP3 file recorded in Variable Bit Rate (VBR), the unit may not display the actual elapsed time.

This unit recommends the files recorded under the following circumstances:

<Applicable MP3 files>

- Sampling frequency: 44.1kHz or 48kHz.
- Constant bit rate: 112kbps - 320kbps.

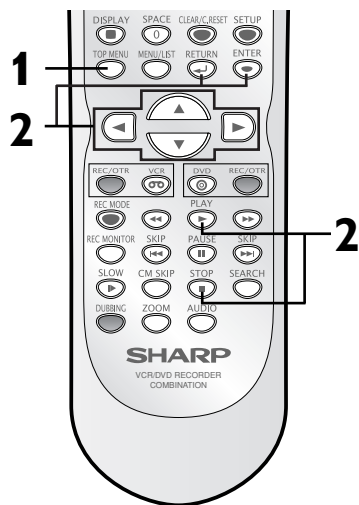

Note

- The audio source of MP3 files cannot be recorded as digital sound by an MD or DAT deck.
- Files whose extension is other than ".mp3(MP3)" will not appear in the File List.
- Some unplayable folders or tracks may appear in the File List due to the recording status.

Disc Playback

Basic playback (cont'd)

Playing back discs using the disc menu



A DVD disc contains a disc menu that describes the contents or allows you to customize the playback. For example, the menu may offer choices for subtitle languages, special features, or chapter selection.

Some discs display them automatically when you start playback. For others, they only appear when you press **MENU/LIST**.

press first.

1

Press MENU/LIST.

The DVD main menu will appear.

If the feature is not available, may appear on the TV screen.



2

Select an item using Cursor \blacktriangle / \blacktriangledown / \blacktriangleleft / \blacktriangleright , then press ENTER to confirm.

Continue this step to set up all the features you want or to start playing back the disc from the menu.

MENU/LIST button:

Displays a DVD disc menu. It may be the same with the "Title menu".

Cursor \blacktriangle / \blacktriangledown / \blacktriangleleft / \blacktriangleright buttons:

Moves the cursor on the screen.

ENTER button:

Selects the currently highlighted menu option.

Number buttons:

Selects a numbered menu option (available only on certain discs). (Press **ENTER** after.)

3

Press MENU/LIST to exit.

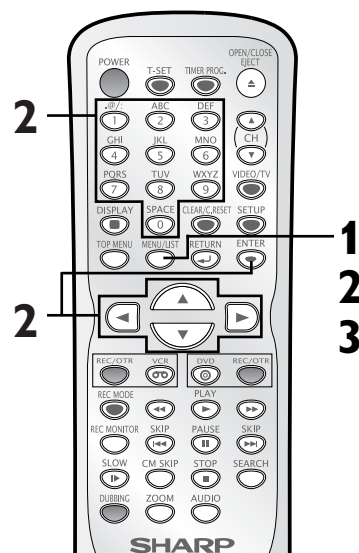

Note

- Menus vary among discs. Refer to the information accompanying the disc for details.

Disc Playback

Basic playback (cont'd)

Playing back discs using the title menu



Some DVDs have a title menu, which lists the titles available on them. It helps you to start playback of a specific title.

press first.

1

Press **TOP MENU**.

The title menu will appear.

If the feature is not available, may appear on the TV screen.

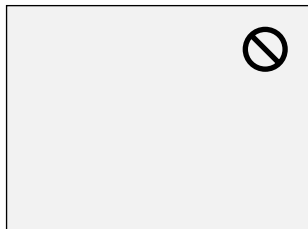

2

Select a title to play back using **Cursor** , then press **ENTER**.

Playback will begin at the title you selected.

TOP MENU button:

Displays the "Title menu" of a DVD disc.

Cursor button:

Moves the cursor on the screen.

ENTER button:

Selects the currently highlighted menu option.

Number buttons:

Selects a numbered menu option (available only on certain discs). (Press **ENTER** after.)

3

Press **TOP MENU** to exit.

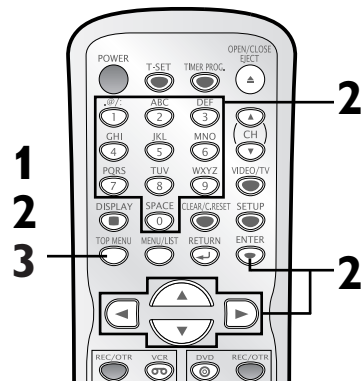

Note

- The **TOP MENU** button will not always be active with all DVDs.
- Menus vary among discs. Refer to the information accompanying the disc for details.

Disc Playback

Special playback

Resume playback



You can resume playback from where you stopped it last time.

**1**

During playback, press **STOP** ■.

The resume message will appear.

**2**

Press **PLAY** ►.

Within a few seconds, playback will resume from the point at which it stopped last. You can resume playback at the same point even if you turn off the unit.

To cancel resuming and start disc playback from the beginning, press **STOP** ■ again while the playback is stopped.

Fast forward / Fast reverse

**1**

During playback, press ►► or ◀◀.

Every time you press ►► or ◀◀, approximate speed will be changed as follows. For DVD discs, sound will be output during x1.5 fast forward only if you set "Fast Forward with Audio" to "ON" at the "Playback" setting in the setting menu.

Fast forward or fast reverse playback across titles (for DVD discs) or tracks (for MP3) is not possible.

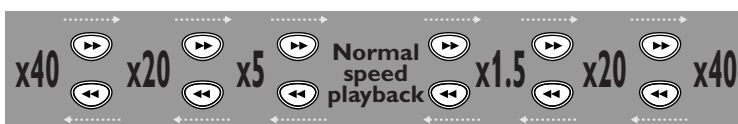

For Audio CDs, approximate speed is fixed at x8 with sound.

For MP3 files, approximate speed is fixed at x16.

To return to the normal playback, press **PLAY** ►.

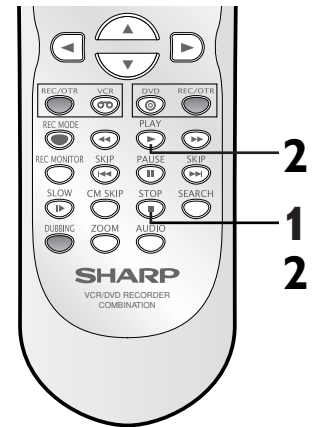
**Note**

- For MP3 file, playback will resume from the beginning of the track which you stopped playing back.

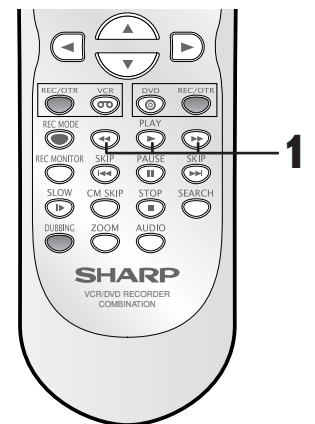
**Note**

- Forward/reverse speed will be indicated with icons as follows.

Forward (Approx. Speed)	
x1.5:	►►
x20:	►►►
x40:	►►►►
Reverse (Approx. Speed)	
x5:	◀◀
x20:	◀◀◀
x40:	◀◀◀◀

Disc Playback

Special playback (cont'd)

Skipping TV commercials during playback



You can skip TV commercials by pressing **CM SKIP** in order to enjoy the recorded programs without interruption.



e.g. Press **CM SKIP** once.

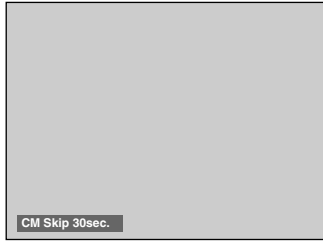

(forwarding 30 seconds.)



Playback will restart automatically.

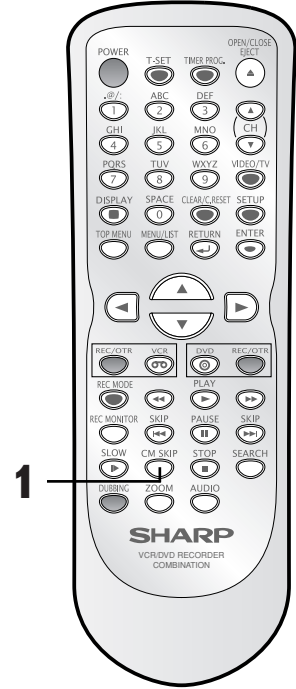

1

During playback, press **CM SKIP**.

Normal playback will start at 30-second advanced point from where you press **CM SKIP**. Every time you press **CM SKIP**, the playback starting point will be extended by 30 seconds ahead. You can press up to 6 times (180 seconds).

Pause



2

Press **PLAY** to resume playback.

1

During playback, press **PAUSE II**.

Playback will pause and sound will be muted.

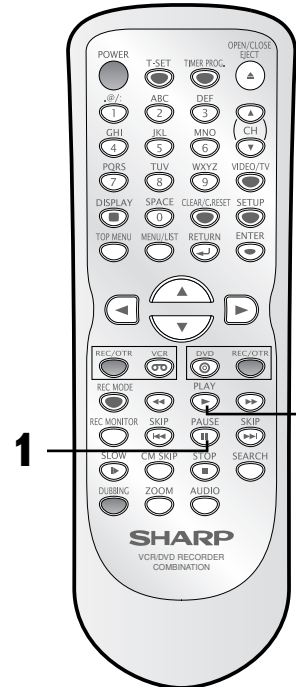
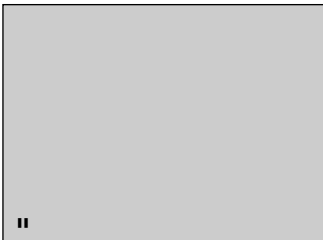

Disc Playback

Special playback (cont'd)

Step by step playback



1

During playback, press **PAUSE II**.

Playback will be paused and sound will be muted.

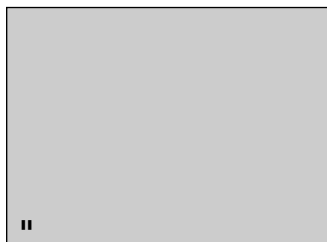

2

Press **SKIP ►►** repeatedly.

The playback will advance one frame (or step) at a time when you press **SKIP ►►**. The sound will be muted.

To play back step by step backward:

Press **SKIP ◄◄** repeatedly.

Every time you press the button, the playback will go backward by one frame at a time.

3

Press **PLAY ►** to resume playback.

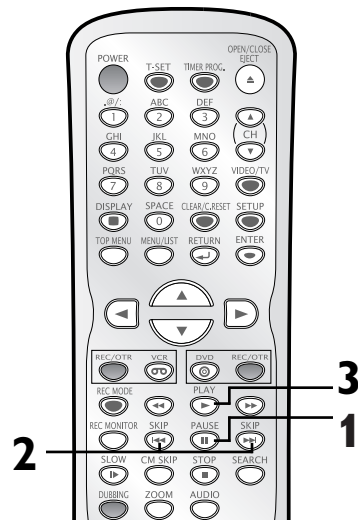

Slow forward / Slow reverse playback



1

During playback, press **PAUSE II**, then press **►►** or **◄◄**.

Every time you press **►►** or **◄◄**, approximate speed will change as follows. (The sound will remain muted.)

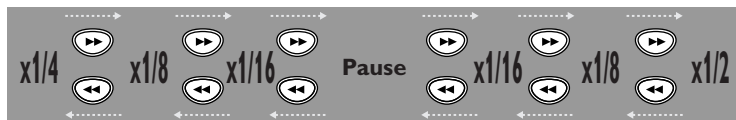

To return to the normal playback, press **PLAY ►**.

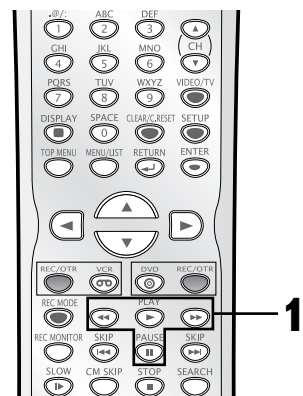

Note

• Forward/reverse speed will be indicated with icons as follows.

Forward (Approx. Speed)

x1/16: ►►►

x1/8: ►►►►

x1/2: ►►►►►

Reverse (Approx. Speed)

x1/16: ◄◄◄

x1/8: ◄◄◄◄

x1/4: ◄◄◄◄◄

Disc Playback

Special playback (cont'd)

Zoom



press first.

1

During playback, press **ZOOM**.

Zoom menu will appear.

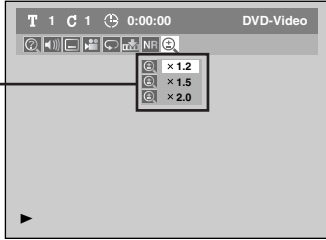

There are four options (x1.0, x1.2, x1.5 and x2.0), which will be displayed excluding the current zoom rate.

2

Select a desired zoom factor to zoom using **Cursor ▲ / ▼**, then press **ENTER**.

The zoom area will be displayed.

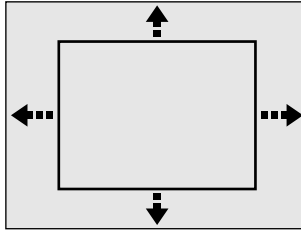

3

Select a desired zoom position using **Cursor ▲ / ▼ / ◀ / ▶**, then press **ENTER**.

The zoom playback will start.

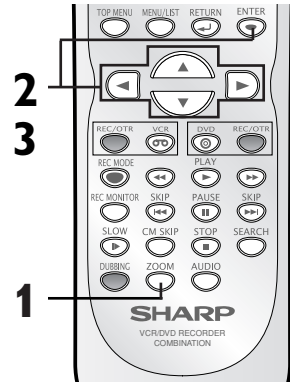

Note

- When selecting a smaller factor than the current one, the zoom area will not be displayed.
- To remove the zoom menu, press **ZOOM** again at STEP 1.
- To cancel the zoom function, select x1.0 using **Cursor ▲ / ▼**, then press **ENTER**.

Disc Playback

Special playback (cont'd)

Marker Setup



press first.

This feature allows you to assign a specific point on a disc to be called back later.

1

During playback, press **DISPLAY**.

The display menu will appear.

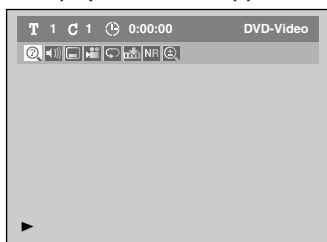

2

Select icon using **Cursor** / , then press **ENTER**. Marker Setting menu will appear.

Screen for DVD:

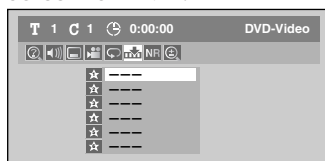

Screen for Audio CD:

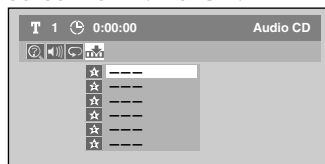

3

Select a desired marker number using **Cursor** / . When it reaches the desired point, press **ENTER**.

4

To return to the marker later, select the desired marker number using **Cursor** / , then press **ENTER**.

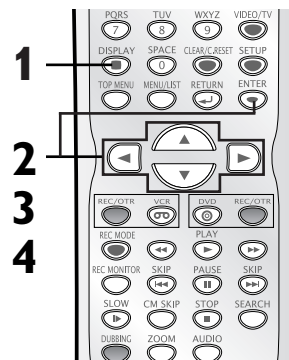

Note

- To clear a marker, select the marker number to be cleared, then press **CLEAR/C.RESET**.
- You can mark up to 6 points.
- All markers will be erased if you perform the following operations;
 - Opening the disc tray.
 - Turning off the power.
 - making additional recording.
 - Changing the mode between Original and Playlist (VR mode).

Disc Playback

Search

Title/Chapter search



Using SKIP ◀◀ / ▶▶

1

During playback, press **SKIP ▶▶** to skip the current title or chapter and move to the next.

To go back to the beginning of the current title or chapter, press **SKIP ◀◀**. Press it repeatedly to go to the previous titles or chapters.

Using DISPLAY

1

During playback, press **DISPLAY**.

The display menu will appear.

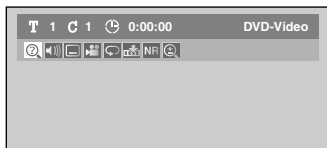

2

Select **?** icon using **Cursor ◀ / ▶**, then press **ENTER**.

The title number next to **T** will be highlighted.

Title:

Enter a desired title number to search using **Cursor ▲ / ▼** or the **Number** buttons, then press **ENTER**.

Title search will start.

Chapter:

To move to **C** for chapter, press **Cursor ▶**.

Enter a desired chapter number to search using **Cursor ▲ / ▼** or the **Number** buttons, then press **ENTER**.

Chapter search will start.

Note

- In search mode display, total numbers of each search contents (title/chapter/time) are shown as a denominator.

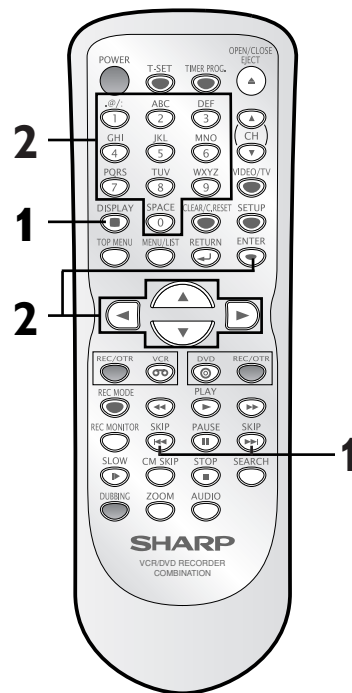
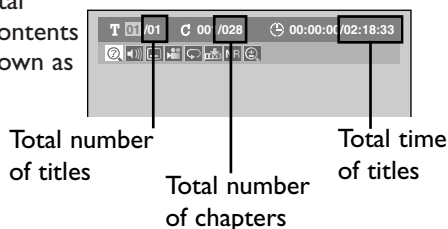

Disc Playback

Search (cont'd)

Track search



press first.

Using SKIP /

1

During playback, press **SKIP** to skip the current track and move to the next. To go back to the beginning of the current track, press **SKIP** . Press it repeatedly to go to the previous tracks.

Using DISPLAY

1

During playback, press **DISPLAY**.

The display menu will appear.

Screen for Audio CD:



Screen for MP3:



2

Select icon using **Cursor** / , then press **ENTER**.

The track number next to **T** will be highlighted.

3

Enter a desired track number to search using **Cursor** / or the **Number** buttons, then press **ENTER**. Track search will start.

Time search



press first.

1

During playback, press **DISPLAY**.

Display menu will appear.

Screen for DVD:

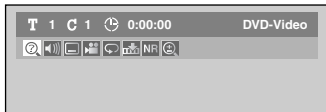

Screen for Audio CD:

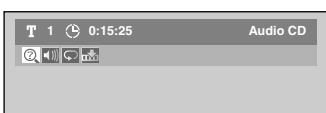

2

Select icon using **Cursor** / , then press **ENTER**.

The number next to **T** will be highlighted.

To move to the clock icon , press **Cursor** .

When time search is not available “- - - - - / - - - - -” (“0:00:00/0:00:00” for Audio CD) is displayed instead of time count.

3

Enter a desired time to search using **Cursor** / or the **Number** buttons, then press **ENTER**. Time search will start.

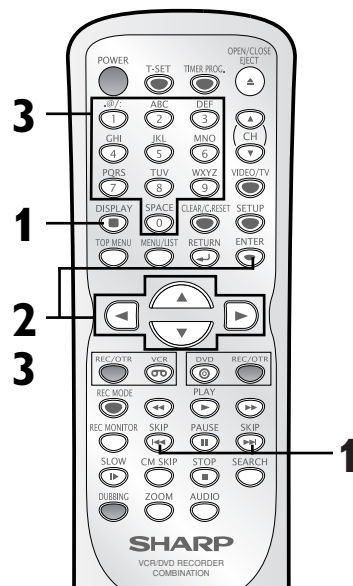

Note

- During Audio CD playback you can enter a track number directly using the **Number buttons** for Track search without displaying the menu.
- For Audio CDs and MP3, Track search is not available for programmed or random playback.

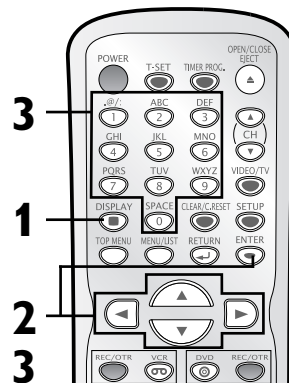

Note

- Time search function is available only within the same track or title.

Disc Playback

Repeat/Random/Program playback

Repeat playback



1

During playback, press **DISPLAY**.

Display menu will appear.

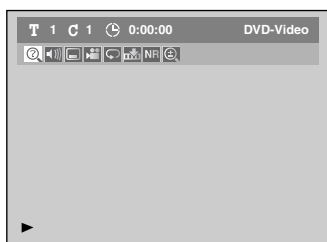

2

Select icon using **Cursor** **◀/▶**, then press **ENTER**.

Repeat menu will appear.

Screen for DVD:

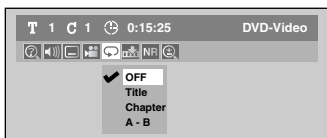

Screen for Audio CD:

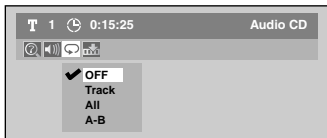

Screen for MP3:

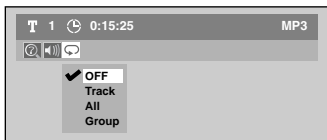

3

Select a desired option for repeat playback using **Cursor** **▲/▼**, then press **ENTER**.

The selected repeat playback will start.

Title:

The current title will be played back repeatedly (DVD only).

Chapter:

The current chapter will be played back repeatedly (DVD only).

All:

The current disc will be played back repeatedly (DVD-RW (VR mode), Audio CD and MP3 only).

A-B:

The A-B point will be played back repeatedly.

When pressing **ENTER** while A-B is highlighted, the unit becomes ready for the input.

Press **ENTER** again to decide the starting point (A).

Press **ENTER** again to select the ending point (B) (DVD and Audio CD only).

Track:

The current track will be played back repeatedly (Audio CD and MP3 only).

Group:

The current group will be played back repeatedly (MP3 only).

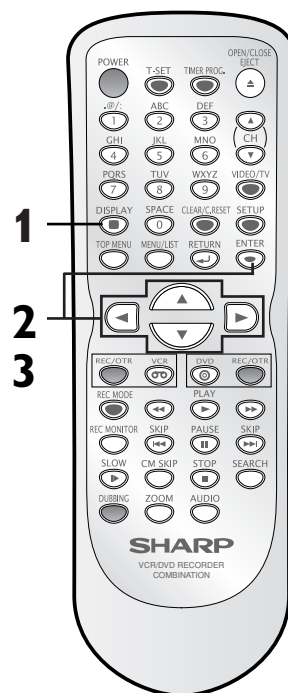

Note

- The A-B Repeat playback can only be set within the current title (for DVDs), or current track (for Audio CDs).
- To cancel the repeat playback, select OFF at STEP 2. The repeat setting will be also cleared when you stop playback.
- You cannot select "Group" for repeat playback during the random playback of MP3 file.

Disc Playback

Repeat/Random/Program playback (cont'd)

Random playback



With this function, you can play back a disc randomly instead of playing back in the original order.

1

Press **SETUP**.

Easy Setting Menu or Advanced Setting Menu will appear.

2

Select "CD Playback Mode" using Cursor **▲** / **▼**, then press **ENTER**.

CD Playback Mode menu will appear. Screen for Audio CD:

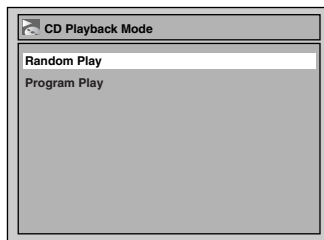

3

Select "Random Play" using Cursor **▲** / **▼**, then press **ENTER**. Random playback will start.

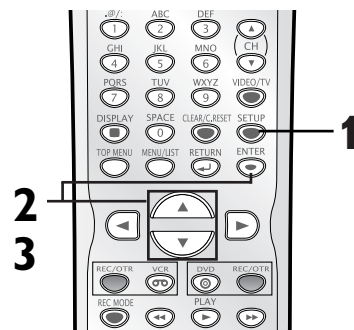

Note

- To cancel random playback, press **STOP** **■** twice during random playback. "Playmode OFF" appears on the screen.

Program playback



You can program a playback sequence in your desired order.

1

Press **SETUP**.

Easy Setting Menu or Advanced Setting Menu will appear.

2

Select "CD Playback Mode" using Cursor **▲** / **▼**, then press **ENTER**.

CD Playback Mode menu will appear.

Screen for Audio CD:

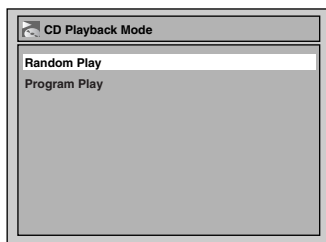

3

Select "Program Play" using Cursor **▲** / **▼**, then press **ENTER**.

Program Play list will appear.

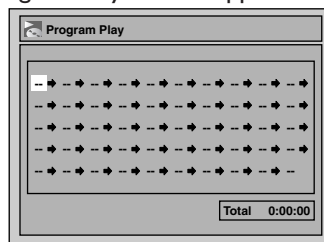

4

Select a desired track using Cursor **▲** / **▼** or the Number buttons, then press **ENTER** or Cursor **▶**.

A cursor will move to next.

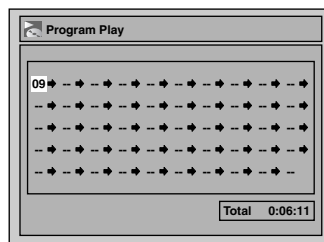

5

Press **PLAY** **▶** to start program playback. Program playback will start.

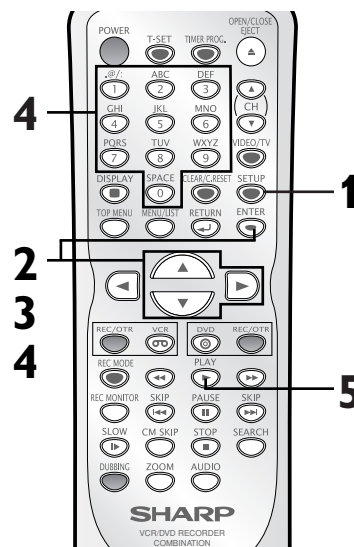

Note

- To erase tracks you selected, press **CLEAR/C.RESET**.
- You can make program settings up to 50.
- To cancel program playback, press **STOP** **■** twice during program playback. "Playmode OFF" appears on the screen.
- You may also select a desired track using the **Number buttons** at STEP 4.

Disc Playback

Selecting a format of audio and video

You can select a desired audio and video format. Selections depend on the contents of the disc you are playing back.

Switching audio soundtracks



When playing back a DVD-Video disc recorded with two or more soundtracks (these are often in different languages), you can switch between them during playback.

On DVD-RW discs recorded in VR mode, you can switch to main (L), sub audio (R) or a mix of both (L/R).



1

During playback, press **DISPLAY**.

Display menu will appear.

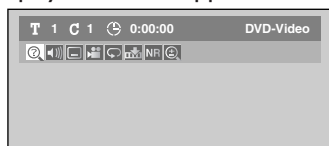

2

Select icon using **Cursor** ◀ / ▶, then press **ENTER**.

Audio menu will appear.

Screen for DVD-Video:

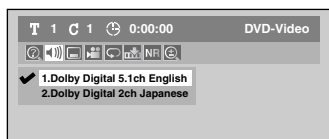

Screen for DVD-RW VR mode:

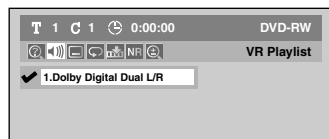

3

Select a desired audio soundtrack using **Cursor** ▲ / ▼, then press **ENTER**.

Audio soundtrack will change.

Screen for DVD-RW VR mode:

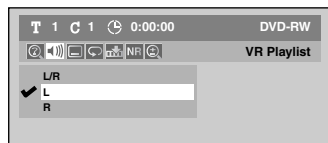

4

Select a desired audio channel using **Cursor** ▲ / ▼, then press **ENTER**.

Audio channel will change.

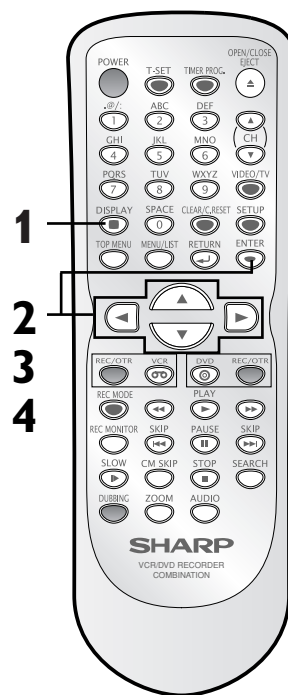

Note

- Some discs will only allow you to change the soundtrack from the disc's menu. Press **TOP MENU** or **MENU/LIST** to display the disc's menu.
- On DVD-RW discs recorded in VR mode with both main and sub audio, you can switch to main (L), sub audio (R) or a mix of both (L/R).
- This unit **CANNOT** record in both stereo and SAP (Secondary Audio Program) at the same time.

Disc Playback

Selecting a format of audio and video (cont'd)



When playing back Audio CDs or MP3 files, you can switch among stereo, the left channel only and the right channel only.



1

During playback, press **DISPLAY**.

Display menu will appear.

Screen for Audio CD:



2

Select icon using **Cursor** ◀ / ▶, then press **ENTER**.

Audio menu will appear.

3

Select a desired audio channel using **Cursor** ▲ / ▼, then press **ENTER**.

Audio channel will change.

Screen for Audio CD:

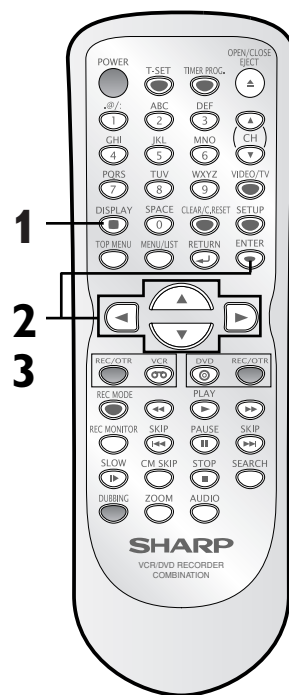
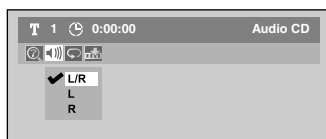

Switching subtitles



Many DVD Video discs have subtitles in one or more languages – they usually tell you which subtitle languages are available. You can switch subtitle languages anytime during playback.



1

During playback, press **DISPLAY**.

Display menu will appear.

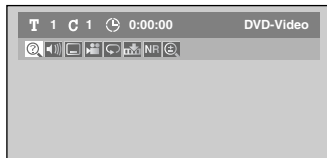

2

Select icon using **Cursor** ◀ / ▶, then press **ENTER**.

Subtitle menu will appear.

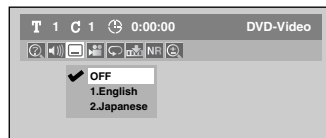

3

Select a desired subtitle language using **Cursor** ▲ / ▼, then press **ENTER**.

Subtitles will be displayed in the selected language.

When selecting “OFF”, subtitles will disappear.

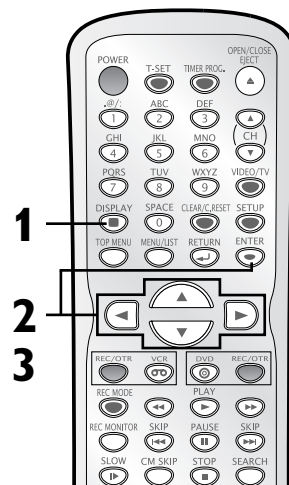

Note

- Some discs will only allow you to change subtitles from the disc menu. Press **TOP MENU** or **MENU/LIST** to display the disc menu.
- If a 4-digit language code appears in the subtitle menu at STEP 2, please refer to the Language code on page 102.

Disc Playback

Selecting a format of audio and video (cont'd)

Switching camera angles



Some DVD Video discs feature scenes shot from two or more angles. The disc package should be marked with an angle icon if it contains multi-angle scenes.



1

During playback, press **DISPLAY**.

Display menu will appear.

Screen for DVD:

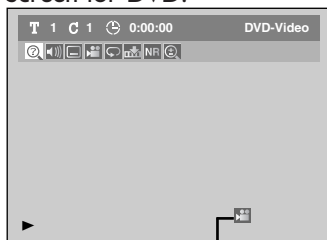

Angle icon appears when different camera angles are available.

2

Select icon using **Cursor** ◀ / ▶, then press **ENTER**.

Angle will switch each time you press **ENTER**.

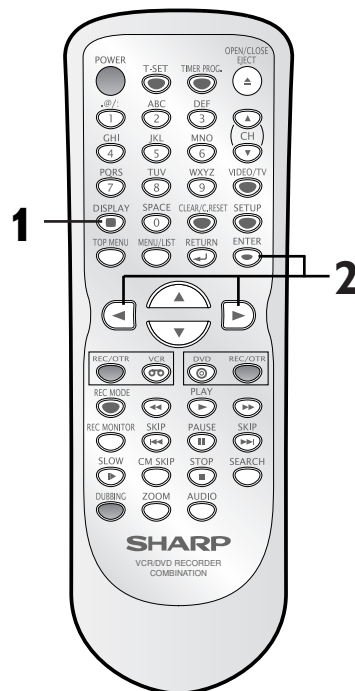

Visual Noise Reduction



1

During playback, press **DISPLAY**.

Display menu will appear.

Screen for DVD:

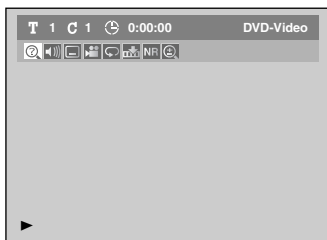

Screen for DVD:

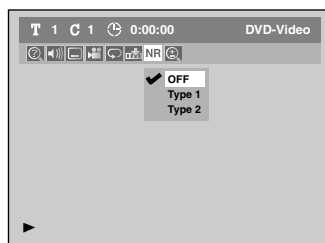

3

Select a desired option using **Cursor** ▲ / ▼, then press **ENTER**.

Your setting will be activated.

This function reduces visual noise. When playing back discs recorded in long time mode such as SLP or SEP mode, select "Type 1" or "Type 2". ("Type 2" is more effective.)

When playing back discs with a few noises such as DVD-Video discs, select "OFF".

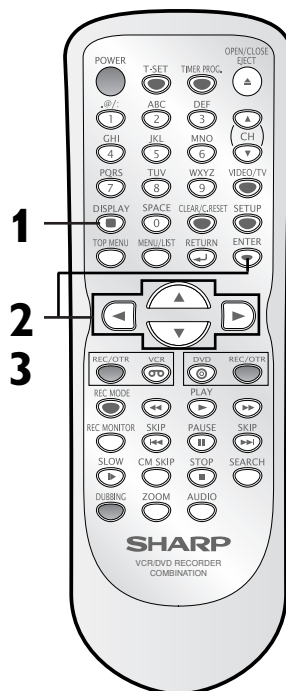

Guide to a Title List

Title List allows you to check the titles recorded on the disc easily. You can choose a title to play back from this screen and easily edit the titles as you prefer.

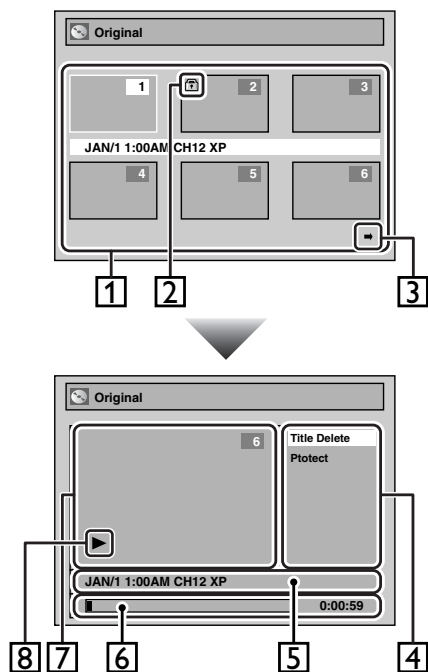

1. Titles recorded on the disc can be selected for editing by pressing **ENTER** with the Cursor on the title.
2. Protect icon, which appears when the title has been protected (Original title only).
3. The arrow icon, which means the Title List has a next or a previous page. Press **Cursor** ◀ / ▶ or **SKIP** ◀◀ / ▶▶ by following direction of the icon.
4. The menus for selecting function for editing titles. The available menus depends on the disc type and the format type. An unavailable item is grayed out.
5. The details of the title. Title name can be changed on the Playlist.
6. Time status bar of the title.
After exiting the edit mode, you can resume playback from that point you stopped for editing.
7. The thumbnail of the title selected from the Title List.
• The selected title will be played back automatically.
8. Playback status of the current disc.

Editing discs in Video mode

You can edit discs with Video mode for the following items. Be sure that once you edit titles, you cannot change them back to the original ones.

- Deleting titles (Refer to page 65)
- Putting names on titles (Refer to pages 66-67)
- Setting or clearing chapter markers (Refer to page 68)

Note

- Once a disc is finalized, editing the disc or recording to the disc will not be available. (Except DVD-RW discs in VR mode.)
- A playlist is not available for the DVD-R discs and DVD-RW discs in Video mode.

After you finish all editing, press **SETUP** to exit the editing mode. "Writing to Disc" appears momentarily. If you open the disc tray, or press **POWER** to turn off the unit, or when a recording error occurs after editing, "Writing to Disc" also appears.

Editing discs in VR mode

For discs with VR mode, you can use either “Original” menu or “Playlist” menu, which is created from the original for editing.

Editing original titles

The following items are available for editing of the original titles.

- Deleting titles (Refer to page 69)
- Setting titles to protect (Refer to page 70)
- Releasing titles from protecting (Refer to page 71)

Editing playlists

You can create a playlist from original titles, in order to edit as you prefer without losing original titles. The following items are available for editing on a Playlist.

- Deleting titles (Refer to page 72)
- Deleting parts of titles (Refer to pages 73-74)
- Putting names on titles (Refer to pages 74-75)
- Setting or clearing chapter markers (Refer to pages 76-77)
- Setting pictures for thumbnails (Refer to page 78)
- Dividing a title (Refer to page 79)
- Combining titles (Refer to page 80)
- Adding titles to a Playlist (Refer to page 81)
- Deleting a Playlist (Refer to page 82)

Note

- Once-edited original titles will not remain as recorded originally. When you want to leave the original as it is, edit the Playlist.

After you finish all editing, press **SETUP** to exit the editing mode. “Writing to Disc” appears momentarily. If you open the disc tray, or press **POWER** to turn off the unit, or when a recording error occurs after editing, “Writing to Disc” also appears.

Deleting titles



You can delete titles which you do not need anymore. Be advised that the titles once deleted cannot be recovered. In Video mode, recordable disc space of DVD-RW disc will increase when the last title on the Title List is deleted.

1
Press **SETUP**. Select “Disc” using **Cursor ▲ / ▼**, then press **ENTER**.
Disc menu will appear.

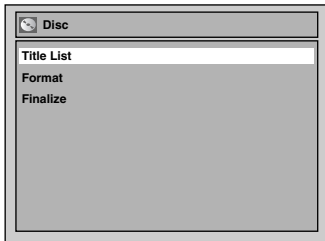

2
Select “Title List” using **Cursor ▲ / ▼**, then press **ENTER**.
Title List will appear.

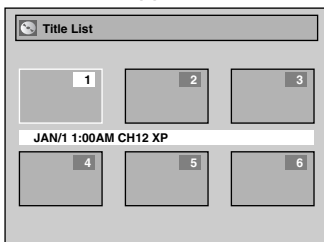

3
Select a desired title using **Cursor ▲ / ▼ / ◀ / ▶**, then press **ENTER**.
Edit menu will appear.

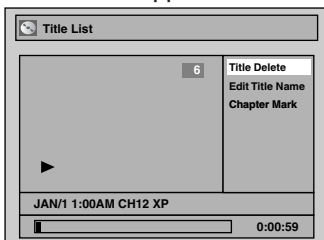

4
Select “Title Delete” using **Cursor ▲ / ▼**, then press **ENTER**.
Confirmation window will appear.

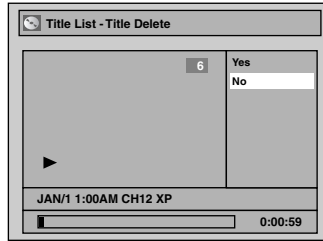

5
Select “Yes” using **Cursor ▲ / ▼**, then press **ENTER**.
Title will be deleted.

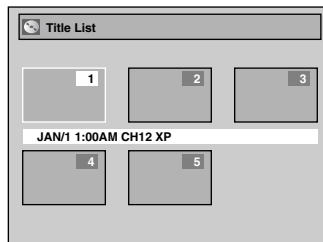

When the only one title is recorded, the Disc menu will not appear after this operation and the unit starts writing the data on the disc automatically.

6
Press **SETUP** to exit.
Writing the data on the disc will start momentarily.

This operation may take a while to be completed.

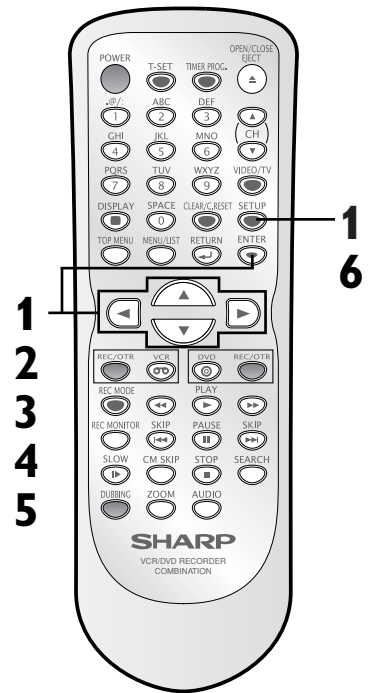

Editing

Editing DVD-RW discs in Video mode (cont'd)

Putting names on titles



You can name titles and change the names from this menu. The names you put on the titles will be displayed on a Title List.

1

Press **SETUP**. Select “Disc” using **Cursor** \blacktriangle / \blacktriangledown , then press **ENTER**.

Disc menu will appear.

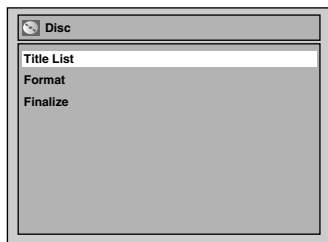

2

Select “Title List” using **Cursor** \blacktriangle / \blacktriangledown , then press **ENTER**.

Title List will appear.

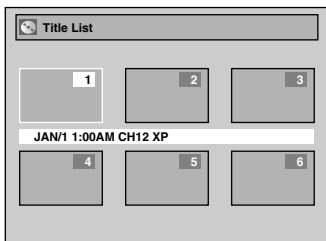

3

Select a desired title using **Cursor** \blacktriangle / \blacktriangledown / \blacktriangleleft / \blacktriangleright , then press **ENTER**.

Edit menu will appear.

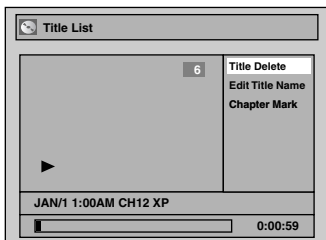

4

Select “Edit Title Name” using **Cursor** \blacktriangle / \blacktriangledown , then press **ENTER**.

A window for entering a title name will appear.

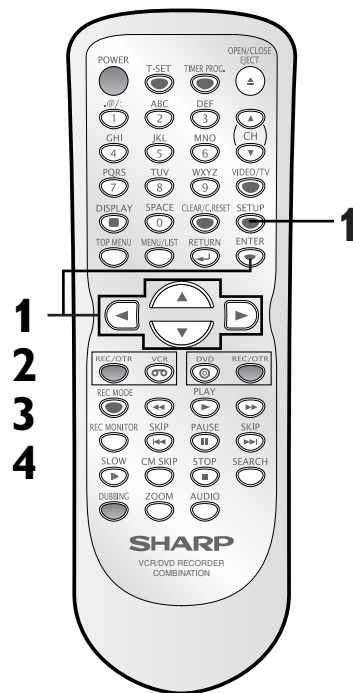
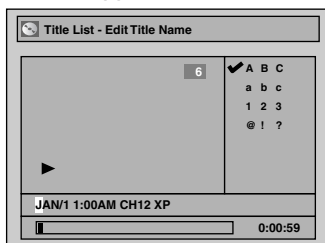

5

To enter a title name, follow the STEPs of “Guide to edit title name” on this page.

character set

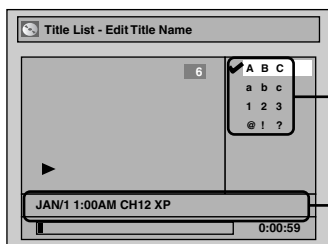

area for entering title names

When you finish entering a title name, press **ENTER**.

Confirmation window will appear.

6

Select “Yes” using **Cursor** **▲ / ▼**, then press **ENTER**.

The name you entered will be activated.

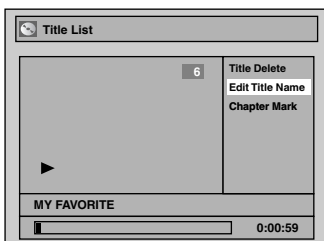

7

After this operation is completed, press **SETUP** to exit. Writing the data on the disc will start momentarily.

This operation may take a while to be completed.

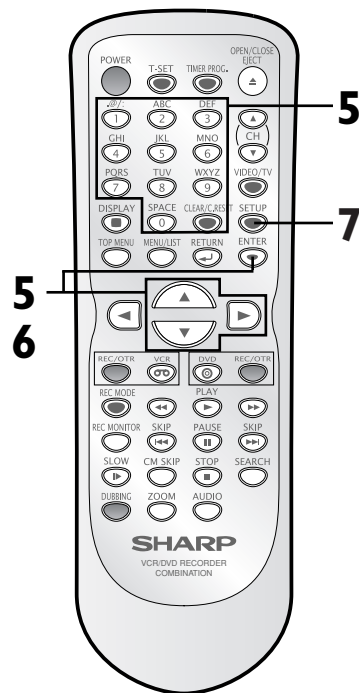

[Guide to edit title name]

[STEP1]: Select a desired character set using **Cursor** **▲ / ▼**, then press **ENTER**.

✓ A B C
a b c
1 2 3
@ ! ?

[STEP2]: Follow the list below, press the **Number** buttons repeatedly until the desired letter appears.

e.g. character set : A B C

Select Press	ABC	abc	123	@ ! ?
0	<space>	<space>	0	<space>
1	—	—	1	! " # \$ % & ' () * + , - . / : ; < = > ? @ [] ^ _ { }
2	A B C	a b c	2	—
3	D E F	d e f	3	—
4	G H I	g h i	4	—
5	J K L	j k l	5	—
6	M N O	m n o	6	—
7	P Q R S	p q r s	7	—
8	T U V	t u v	8	—
9	W X Y Z	w x y z	9	—

Note:
Undefined letters in a title name are shown by “*”. If you delete them, adjoining letters may change to “*” or other.

- Character set will be changed to the “@!?” automatically if you press 1 after you selected the “ABC” or “abc” mode.
- If you want to mix different character sets in one title, repeat STEP [1] and [2] above.
- To delete letters, press **CLEAR/C.RESET** repeatedly. Hold **CLEAR/C.RESET** to delete all letters.
- To go on to the next entering area for letters, press **Cursor** **▶**.
- You can enter up to 30 letters.

Editing

Editing DVD-RW discs in Video mode (cont'd)

Setting or clearing chapter markers



You can put chapter markers on each title and use them for the chapter search feature.

You can specify time interval for chapter markers for titles last more than 5 minutes.

1

Press **SETUP**. Select “Disc” using Cursor **▲ / ▼**, then press **ENTER**.

Disc menu will appear.

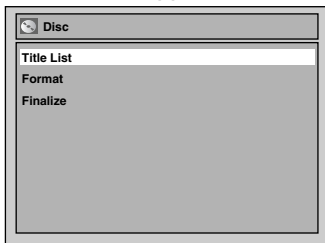

2

Select “Title List” using Cursor **▲ / ▼**, then press **ENTER**.

Title List will appear.

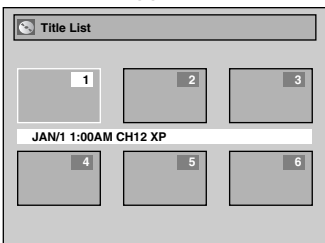

3

Select a desired title using Cursor **▲ / ▼ / ◀ / ▶**, then press **ENTER**.

Edit menu will appear.

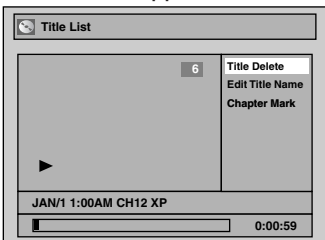

4

Select “Chapter Mark” using Cursor **▲ / ▼**, then press **ENTER**.

Option window will appear.

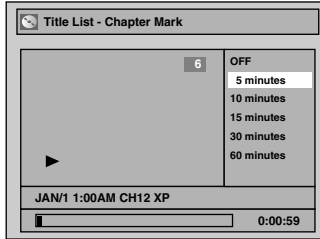

5

Select a desired time using Cursor **▲ / ▼**, then press **ENTER**.

Confirmation window will appear.

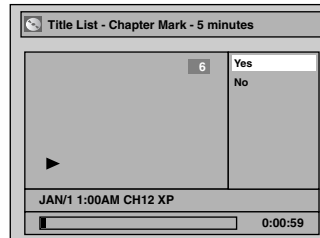

6

Select “Yes” using Cursor **▲ / ▼**, then press **ENTER**.

Chapter markers will be added. If you select “OFF” at STEP 5, all the chapter markers will be erased.

7

After this operation is completed, press **SETUP** to exit.

Writing the data on the disc will start momentarily.

This operation may take a while to be completed.

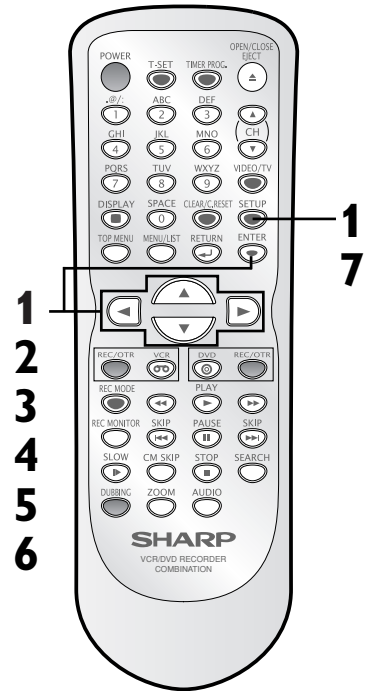

Note

- You cannot select a time interval for markers beyond a length of the title.
- The interval between markers may slightly deviate from the one specified at the STEP 5.
- A chapter marker may be delayed according to the recording content.

Deleting titles



When a title is deleted from an Original in VR mode, the recordable disc space will increase. Be advised that the titles once deleted cannot be recovered.

- 1** Press **SETUP**. Select “Disc” using **Cursor ▲ / ▼**, then press **ENTER**.
Disc menu will appear.



- 2** Select “Original” using **Cursor ▲ / ▼**, then press **ENTER**.
Original list will appear.

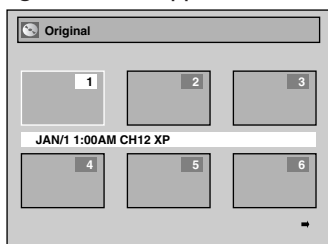

- 3** Select a desired title using **Cursor ▲ / ▼ / ◀ / ▶**, then press **ENTER**.
Edit menu will appear.

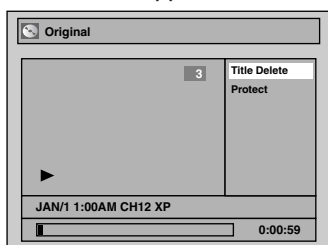

- 4** Select “Title Delete” using **Cursor ▲ / ▼**, then press **ENTER**.
Confirmation window will appear.

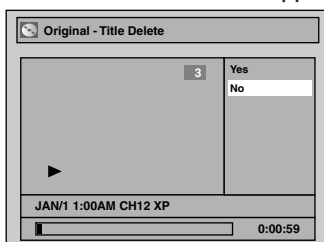

- 5** Select “Yes” using **Cursor ▲ / ▼**, then press **ENTER**.
Title will be deleted.

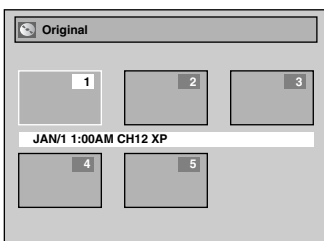

When the only one title is recorded, the Disc menu will not appear after this operation and the unit starts writing the data on the disc automatically.

- 6** After this operation is completed, press **SETUP** to exit.
Writing the data on the disc will start momentarily.

This operation may take a while to be completed.

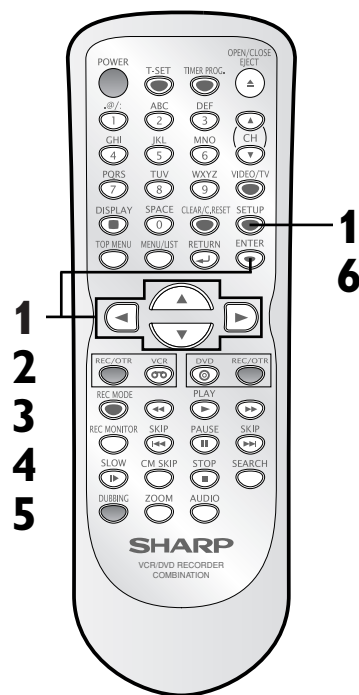

Note

- When a title is deleted from an Original, the title on the Playlist will be also deleted.

Editing

Editing DVD-RW discs in VR mode (Original) (cont'd)

Setting titles to protect



To prevent accidental editing or title erasing, you can protect the contents in the Original menu.

1
Press **SETUP**. Select “Disc” using Cursor **▲ / ▼**, then press **ENTER**.

Disc menu will appear.



2
Select “Original” using Cursor **▲ / ▼**, then press **ENTER**.

Original list will appear.

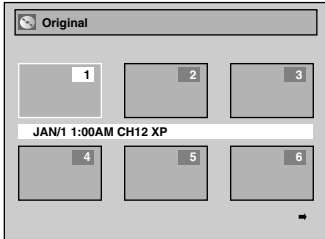

3
Select a desired title using Cursor **▲ / ▼ / ◀ / ▶**, then press **ENTER**.

Edit menu will appear.

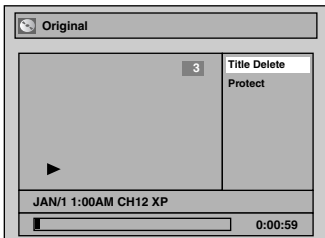

4
Select “Protect” using Cursor **▲ / ▼**, then press **ENTER**. Confirmation window will appear.

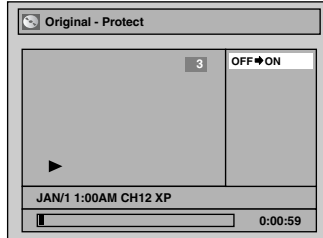

5
Confirm the indication “OFF → ON”. Press **ENTER**.

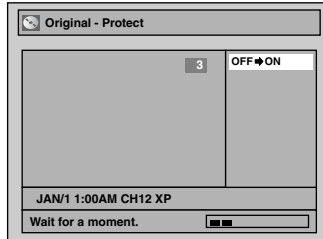

6
After this operation is completed, press **SETUP** to exit. Writing the data on the disc will start momentarily.

This operation may take a while to be completed.

To protect a whole disc (DVD-RW VR mode Only): Select “Disc Protect OFF → ON” from Disc menu, then select “Yes”. Refer to “Setting a disc to protect” on page 41.

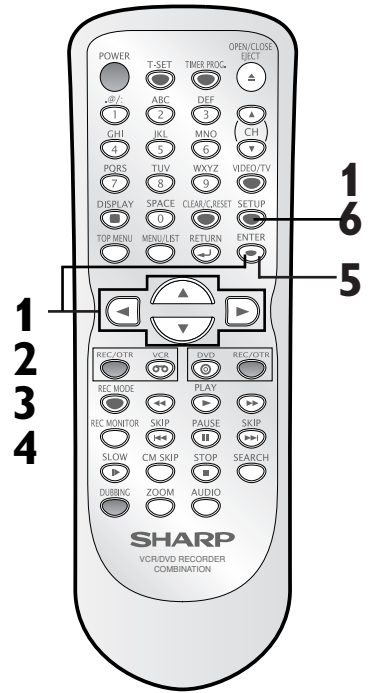

Note

- The protected title will be marked with a key icon on the Original.

Releasing titles from protecting



You can cancel the titles-protecting feature.

1
Press **SETUP**. Select “Disc” using **Cursor** \blacktriangle / \blacktriangledown , then press **ENTER**.
Disc menu will appear.

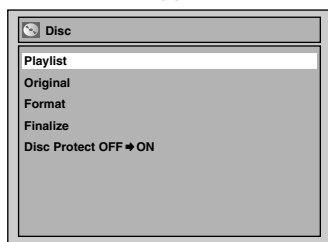

2
Select “Original” using **Cursor** \blacktriangle / \blacktriangledown , then press **ENTER**.
Original list will appear.

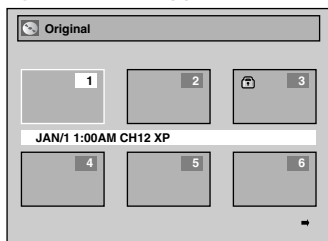

3
Select a desired title using **Cursor** \blacktriangle / \blacktriangledown / \blacktriangleleft / \blacktriangleright , then press **ENTER**.
Edit menu will appear.
“Protect” is already highlighted.

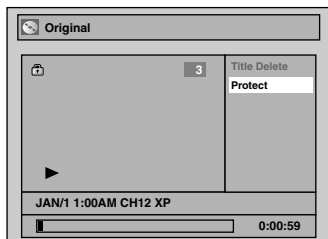

4
Press **ENTER**.
Confirmation window will appear.

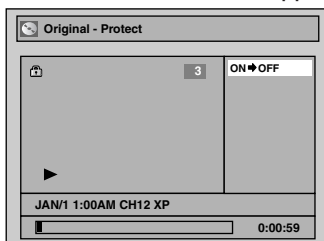

5
Confirm the indication “ON → OFF”. Press **ENTER**.

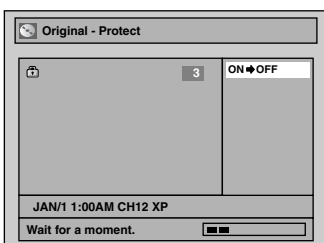

6
After this operation is completed, press **SETUP** to exit.
Writing the data on the disc will start momentarily.

This operation may take a while to be completed.

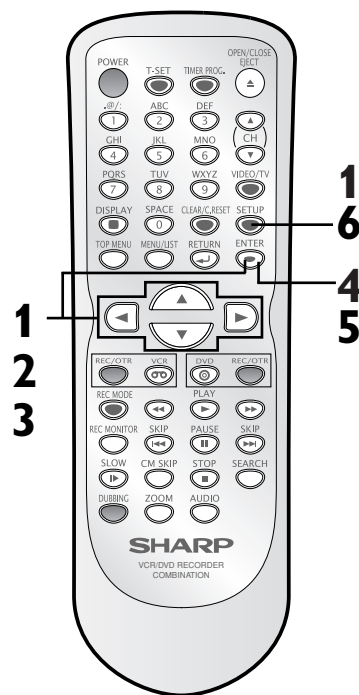

Editing

Editing DVD-RW discs in VR mode (Playlist)

Deleting titles



In VR mode, even if a title is deleted from a Playlist, the original title will remain on the Original. The recordable disc space will not increase.

1
Press **SETUP**. Select **"Disc"** using **Cursor ▲ / ▼**, then press **ENTER**.
Disc menu will appear.

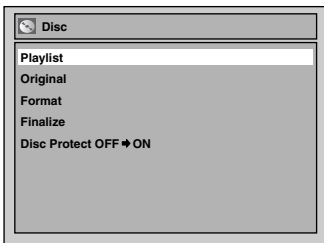

2
Select **"Playlist"** using **Cursor ▲ / ▼**, then press **ENTER**.
Playlist will appear.

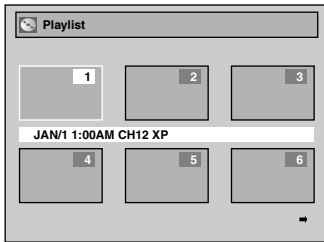

3
Select a desired title using **Cursor ▲ / ▼ / ◀ / ▶**, then press **ENTER**.
Edit menu will appear.

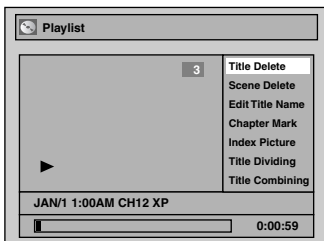

4
Select **"Title Delete"** using **Cursor ▲ / ▼**, then press **ENTER**.
Confirmation window will appear.

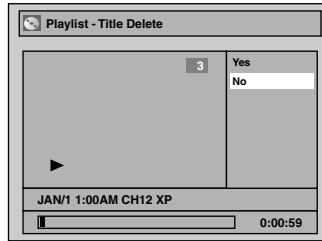

5
Select **"Yes"** using **Cursor ▲ / ▼**, then press **ENTER**.
Title will be deleted.

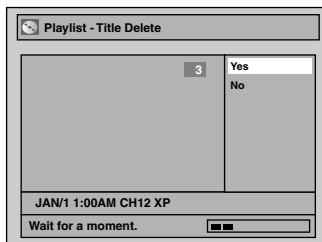

6
After this operation is completed, press **SETUP** to exit.
Writing the data on the disc will start momentarily.

This operation may take a while to be completed.

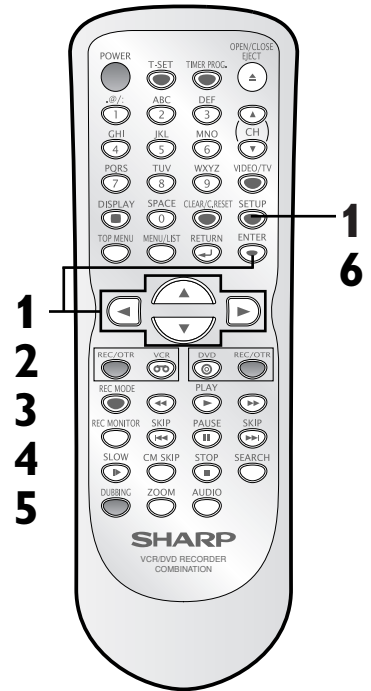

Deleting parts of titles



You can delete a specific part of a title.

Even if a part of a title is deleted from the Playlist, the original title will remain as it was, and the recordable disc space will not increase.

1 Press **SETUP**. Select **"Disc"** using **Cursor ▲ / ▼**, then press **ENTER**.
Disc menu will appear.



2 Select **"Playlist"** using **Cursor ▲ / ▼**, then press **ENTER**.
Playlist will appear.

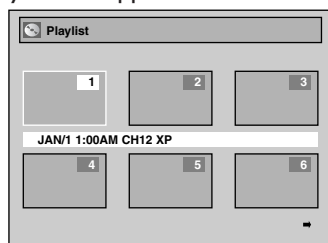

3 Select a desired title using **Cursor ▲ / ▼ / ◀ / ▶**, then press **ENTER**.
Edit menu will appear.

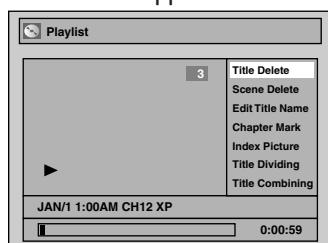

4

Select **"Scene Delete"** using **Cursor ▲ / ▼**, then press **ENTER**.
Option window will appear.

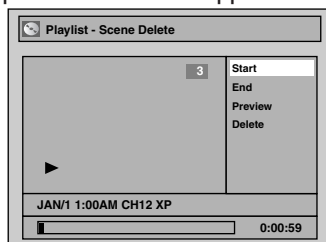

5

Use **SKIP ◀◀ / ▶▶**, **◀◀ / ▶▶**, **PLAY ▶**, and **PAUSE ||** to decide the start point, then press **ENTER**. Then use **SKIP ◀◀ / ▶▶**, **◀◀ / ▶▶**, **PLAY ▶**, and **PAUSE ||** again to move to the end point, and press **ENTER**. Press **ENTER** again to start the preview.

The cursor will move to "Preview."

You can check the preview by pressing **ENTER**.

The bar at the bottom of the screen indicates the total and the elapsed time of the title. The area selected for deletion will be indicated in red during the preview.

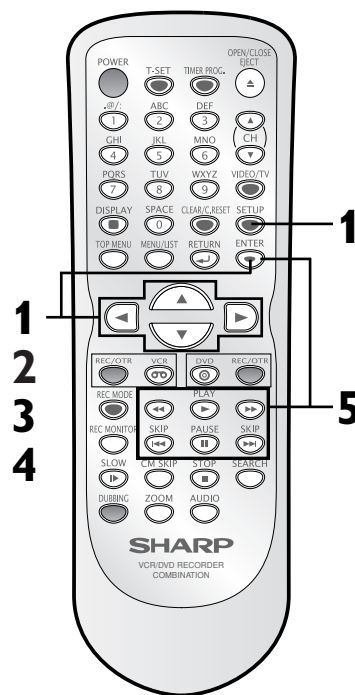

<Preview> Start point End point

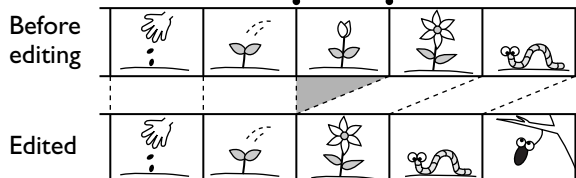

Editing

Editing DVD-RW discs in VR mode (Playlist) (cont'd)

6

Select "Delete" using Cursor ▲ / ▼, then press ENTER.

Confirmation window will appear.

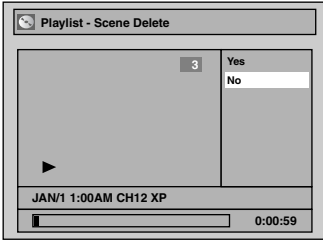

7

Select "Yes" using Cursor ▲ / ▼, then press ENTER.

Part of a title will be deleted.

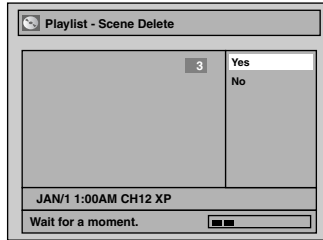

8

After this operation is completed, press SETUP to exit. Writing the data on the disc will start momentarily.

This operation may take a while to be completed.

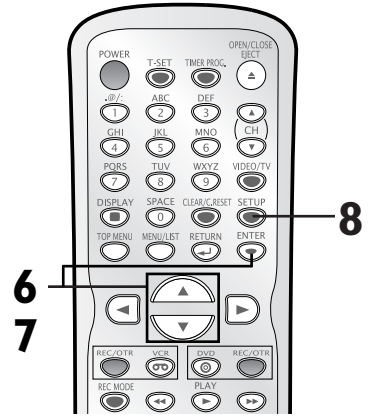

Note

- You cannot select "Scene Delete" when the number of chapter markers in the Original or Playlist exceeds 900.

Putting names on titles



You can name the titles and change the names from this menu.

The names you put on the titles will be displayed on a Title List.

1

Press SETUP. Select "Disc" using Cursor ▲ / ▼, then press ENTER.

Disc menu will appear.

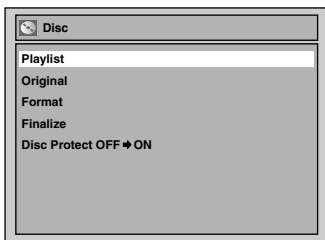

2

Select "Playlist" using Cursor ▲ / ▼, then press ENTER.

Playlist will appear.

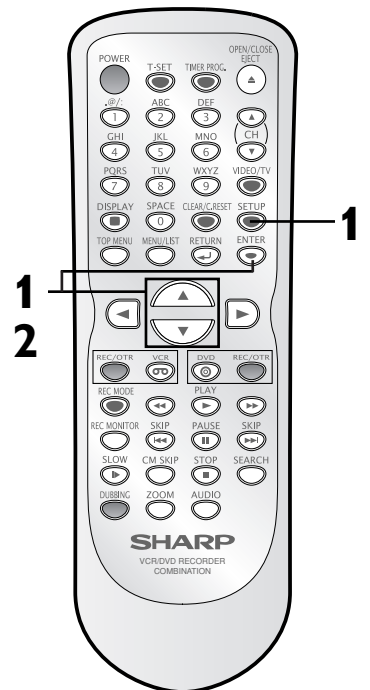
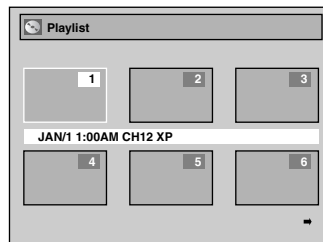

3

Select a desired title using **Cursor** ▲ / ▼ / ◀ / ▶, then press **ENTER**.

Edit menu will appear.

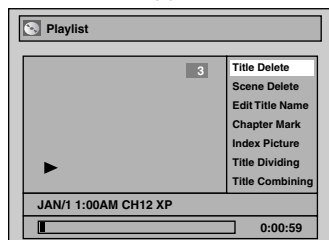

4

Select **“Edit Title Name”** using **Cursor** ▲ / ▼, then press **ENTER**.

A window for entering a title name will appear.

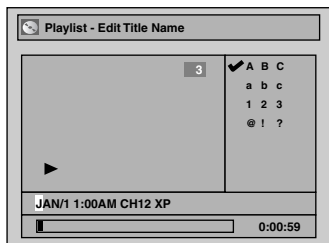

5

To enter a title name, follow the **STEPS** of **“Guide to edit title name”** on this page.

character set

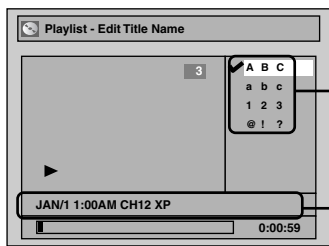

area for entering title names

When you finish entering a title name, press **ENTER**.

Confirmation window will appear.

6

Select **“Yes”** using **Cursor** ▲ / ▼, then press **ENTER**.

The name you entered will be activated.



7

After this operation is completed, press **SETUP** to exit.

Writing the data on the disc will start momentarily.

This operation may take a while to be completed.

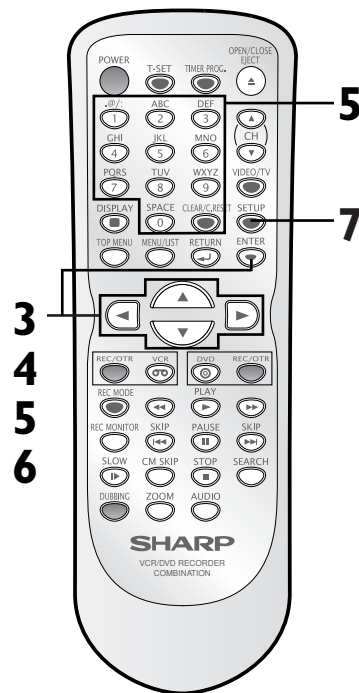

[Guide to edit title name]

[STEP1]: Select a desired character set using **Cursor** ▲ / ▼, then press **ENTER**.

✓ A B C
a b c
1 2 3
@ ! ?

[STEP2]: Follow the list below, press the **Number** buttons repeatedly until the desired letter appears.

e.g. character set : A B C

Select Press	ABC	abc	123	@ ! ?
0	<space>	<space>	0	<space>
1	—	—	1	! " # \$ % & ' () * + , - . / : ; < = > ? @ [] ^ _ { }
2	A B C	a b c	2	—
3	D E F	d e f	3	—
4	G H I	g h i	4	—
5	J K L	j k l	5	—
6	M N O	m n o	6	—
7	P Q R S	p q r s	7	—
8	T U V	t u v	8	—
9	W X Y Z	w x y z	9	—

Note: Undefined letters in a title name are shown by **“*”**. If you delete them, adjoining letters may change to **“*”** or other.

- Character set will be changed to the **“@!?”** automatically if you press **1** after you selected the **“ABC”** or **“abc”** mode.
- If you want to mix different character sets in one title, repeat **STEP [1]** and **[2]** above.
- To delete letters, press **CLEAR/C.RESET** repeatedly. Hold **CLEAR/C.RESET** to delete all letters.
- To go on to the next entering area for letters, press **Cursor** ▶.
- You can enter up to 30 letters.

Editing

Editing DVD-RW discs in VR mode (Playlist) (cont'd)

Setting or clearing chapter markers



You can put chapter markers on each title and can use them for the chapter search feature. You can put a chapter marker anywhere you want until the total number of the markers reaches 999.

1

Press **SETUP**. Select “Disc” using Cursor **▲ / ▼**, then press **ENTER**.

Disc menu will appear.

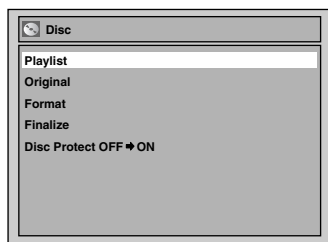

2

Select “Playlist” using Cursor **▲ / ▼**, then press **ENTER**.

Playlist will appear.

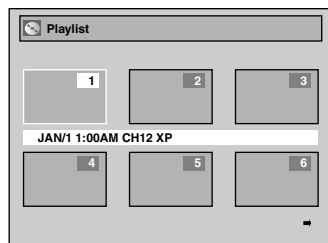

3

Select a desired title using Cursor **▲ / ▼ / ◀ / ▶**, then press **ENTER**.

Edit menu will appear.

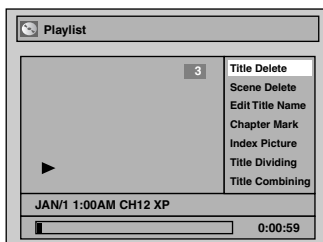

4

Select “Chapter Mark” using Cursor **▲ / ▼**, then press **ENTER**.

Option window will appear.

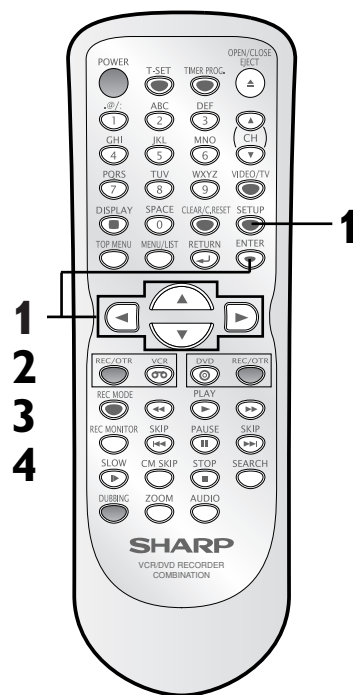
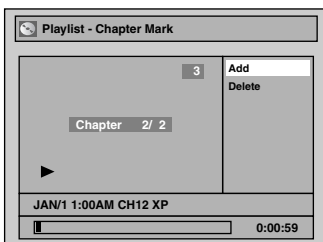

5

Use **SKIP** ◀◀ / ▶▶, ◀ / ▶, **PLAY** ▶, and **PAUSE** || to decide the point for a new chapter marker. Or, use **SKIP** ◀◀ / ▶▶ to decide a chapter marker that you will delete. Select **“Add”** or **“Delete”** accordingly using **Cursor** ▲ / ▼, then press **ENTER**.

Confirmation window will appear.

Screen for Add:

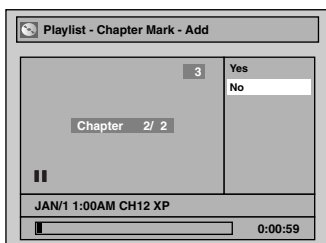

Screen for Delete:

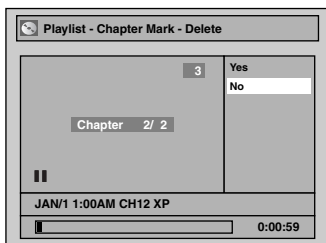

You cannot delete the first chapter of each title.

6

Select **“Yes”** using **Cursor** ▲ / ▼, then press **ENTER**.

A chapter marker will be added at the point you have decided.

Screen for Add:

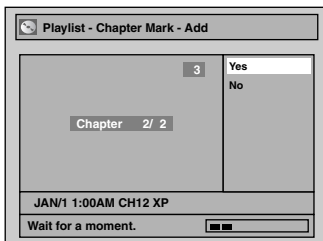

When you select **“Delete”** at **STEP 5**, the chapter marker you have selected will be deleted.

Screen for Delete:

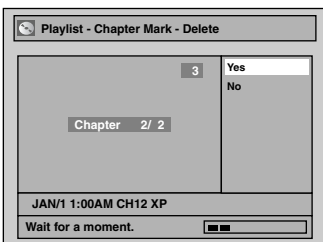

7

After this operation is completed, press SETUP to exit. Writing the data on the disc will start momentarily.

This operation may take a while to be completed.

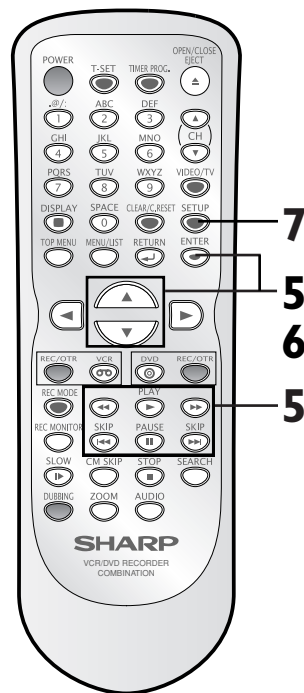

Editing DVD-RW discs in VR mode (Playlist) (cont'd)

Setting pictures for thumbnails



You can set an image picture to each title as thumbnail. It helps you remember the contents of the title during playback. The default setting chooses the first scene of each title as the thumbnail.

1

Press **SETUP**. Select “Disc” using **Cursor ▲ / ▼**, then press **ENTER**.

Disc menu will appear.

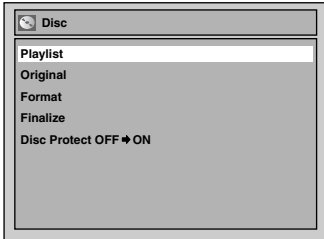

2

Select “Playlist” using **Cursor ▲ / ▼**, then press **ENTER**.

Playlist will appear.

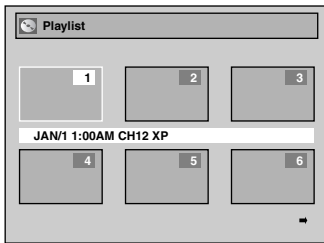

3

Select a desired title using **Cursor ▲ / ▼ / ◀ / ▶**, then press **ENTER**.

Edit menu will appear.

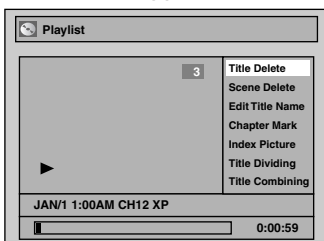

4

Select “Index Picture” using **Cursor ▲ / ▼**. Use **SKIP ◀◀ / ▶▶**, **◀◀ / ▶▶**, **PLAY ▶**, and **PAUSE II** to decide the picture you want to select as thumbnail. Then press **ENTER**.

Confirmation window will appear.



5

Select “Yes” using **Cursor ▲ / ▼**, then press **ENTER**.

A picture for thumbnail will be set.

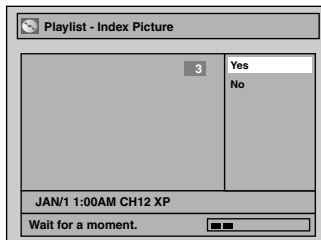

6

After this operation is completed, press **SETUP** to exit. Writing the data on the disc will start momentarily.

This operation may take a while to be completed.

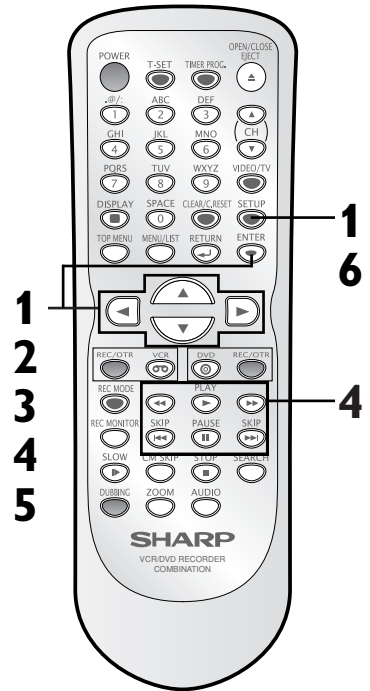

Note

- If a selected picture as thumbnail is deleted by deleting a part of a title, a default picture will automatically replace it.

Dividing a title



You can divide a title into two new titles.

1

Press **SETUP**. Select “Disc” using **Cursor** \blacktriangle / \blacktriangledown , then press **ENTER**.

Disc menu will appear.

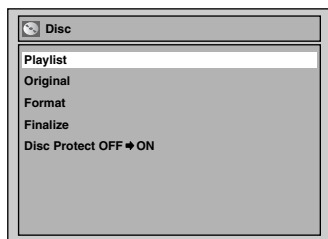

2

Select “Playlist” using **Cursor** \blacktriangle / \blacktriangledown , then press **ENTER**.

Playlist will appear.

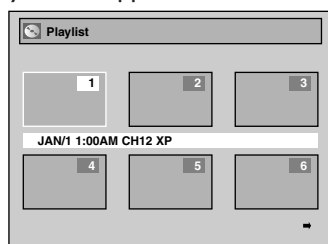

3

Select a desired title using **Cursor** \blacktriangle / \blacktriangledown / \blacktriangleleft / \blacktriangleright , then press **ENTER**.

Edit menu will appear.

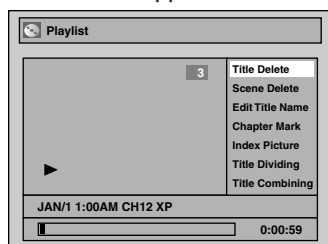

4

Use **SKIP** \blacktriangleleft / \blacktriangleright , \blacktriangleleft / \blacktriangleright , **PLAY** \blacktriangleright and **PAUSE** \parallel to decide the point at which you will divide the title.

Select “Title Dividing” using **Cursor** \blacktriangle / \blacktriangledown , then press **ENTER**.

Confirmation window will appear.

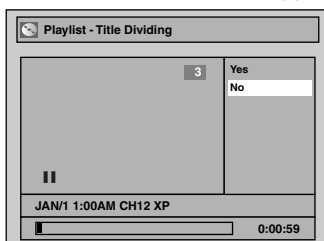

5

Select “Yes” using **Cursor** \blacktriangle / \blacktriangledown , then press **ENTER**.

The title will be divided into two new titles.

Both title names are identical, and index pictures are reset to the first scene of each title.

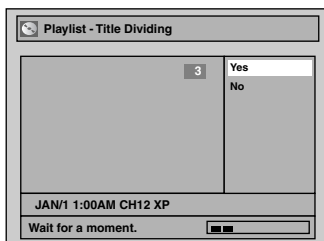

6

After this operation is completed, press **SETUP** to exit. Writing the data on the disc will start momentarily.

This operation may take a while to be completed.

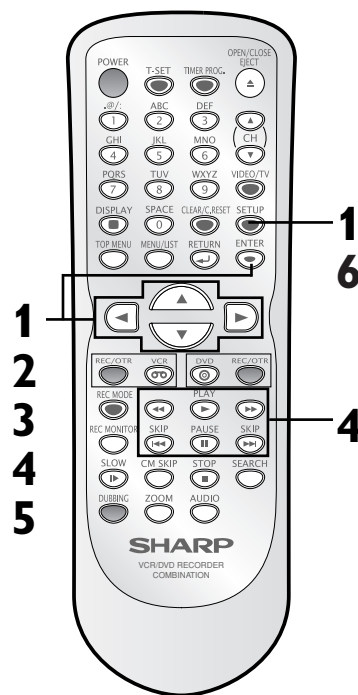

Note

- If a disc contains the maximum number of recording (99), you cannot divide any titles.
- You cannot divide the titles if the total number of the chapters have already reached 999.

Editing DVD-RW discs in VR mode (Playlist) (cont'd)

Combining titles



You can combine two titles into a single title.

1 Press **SETUP**. Select “Disc” using **Cursor** \blacktriangle / \blacktriangledown , then press **ENTER**.

Disc menu will appear.

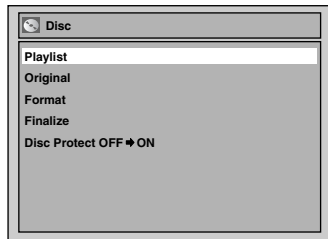

2 Select “Playlist” using **Cursor** \blacktriangle / \blacktriangledown , then press **ENTER**. Playlist will appear.

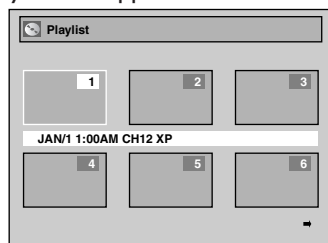

3 Select a desired title using **Cursor** \blacktriangle / \blacktriangledown / \blacktriangleleft / \blacktriangleright , then press **ENTER**.

Edit menu will appear.

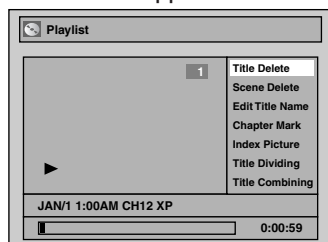

4 Select “Title Combining” using **Cursor** \blacktriangle / \blacktriangledown , then press **ENTER**.

Title Combining setting window will appear.

If you select the title 1 as the first title for Title Combining, it will be grayed out and the title 2 will be highlighted in yellow. If you select another title as the first title, the title 1 will be highlighted in yellow.

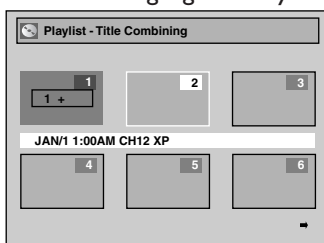

5 Select another title to combine using **Cursor** \blacktriangle / \blacktriangledown / \blacktriangleleft / \blacktriangleright , then press **ENTER**.

Confirmation window will appear.

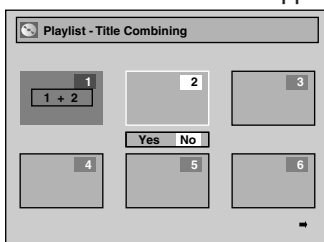

6 Select “Yes” using **Cursor** \blacktriangleleft / \blacktriangleright , then Press **ENTER**.

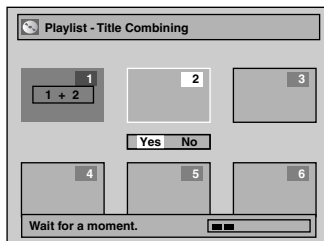

Two titles will be combined into a single title.

7 After this operation is completed, press **SETUP** to exit. Writing the data on the disc will start momentarily.

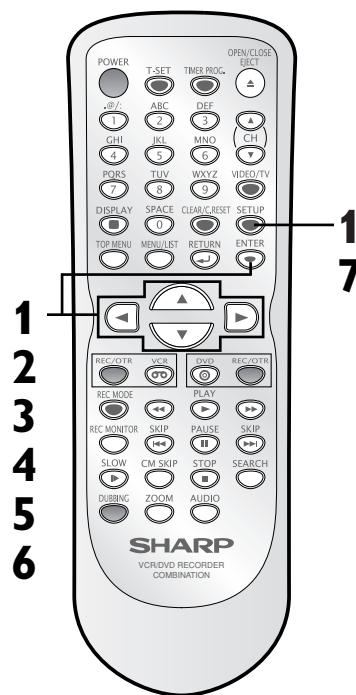

Note

- If either one of the two combined titles is deleted from the original list, the combined title in the Playlist is also deleted.
- The name of the title selected first will become the name of the combined title.
- The title selected first will be the first part of the combined title.

This operation may take a while to be completed.

Adding titles to a Playlist



You can add or delete a title on the Playlist as you prefer.

You can add up to 99 titles to a Playlist.

1 Press **SETUP**. Select “Disc” using Cursor **▲ / ▼**, then press **ENTER**.

Disc menu will appear.



2 Select “Playlist” using Cursor **▲ / ▼**, then press **ENTER**.

Playlist will appear.

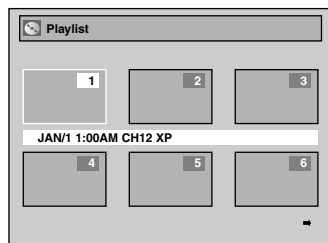

3 Use Cursor **▲ / ▼ / ◀ / ▶** to select “Add New Title” at the end of the titles. Then, press **ENTER**.

Original will appear.

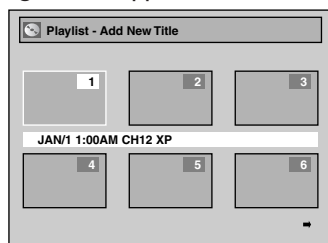

4 Select a desired title using Cursor **▲ / ▼ / ◀ / ▶**, then press **ENTER**.

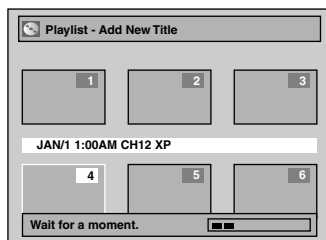

5 After this operation is completed, press **SETUP** to exit. Writing the data on the disc will start momentarily.

This operation may take a while to be completed.

To delete a title from Playlist, refer to “Deleting titles” on page 72.

To delete a Playlist, refer to “Deleting a Playlist” on page 82.

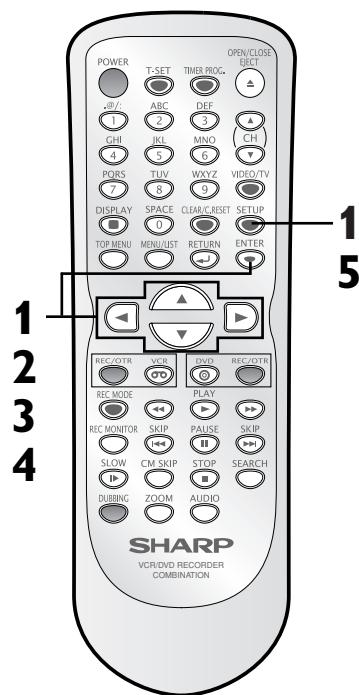

Note

- When a Playlist contains 99 titles or more, or 999 chapters or more, Add New Title cannot be selected.

Deleting a Playlist



A Playlist can be deleted if no longer needed.

1
Press **SETUP**. Select “Disc” using Cursor \blacktriangle / \blacktriangledown , then press **ENTER**.

Disc menu will appear.

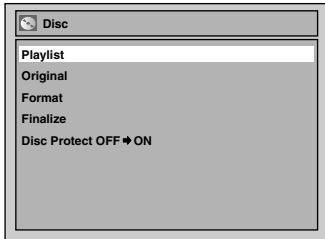

2
Select “Playlist” using Cursor \blacktriangle / \blacktriangledown , then press **ENTER**.

Playlist will appear.

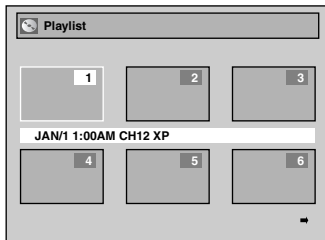

3
Use Cursor \blacktriangle / \blacktriangledown / \blacktriangleleft / \blacktriangleright to select “Add New Title” at the end of the titles. Then, select “Delete Playlist” using Cursor \blacktriangle / \blacktriangledown , then press **ENTER**.

Confirmation window will appear.

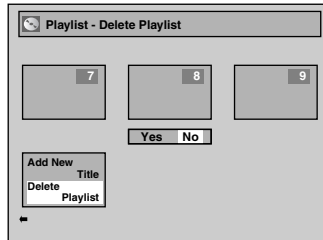

4
Select “Yes” using Cursor \blacktriangleleft / \blacktriangleright , then press **ENTER**.

A Playlist will be erased.

5
After this operation is completed, press **SETUP** to exit. Writing the data on the disc will start momentarily.

The unit will be in stop mode after exiting the Disc menu automatically.

This operation may take a while to be completed.

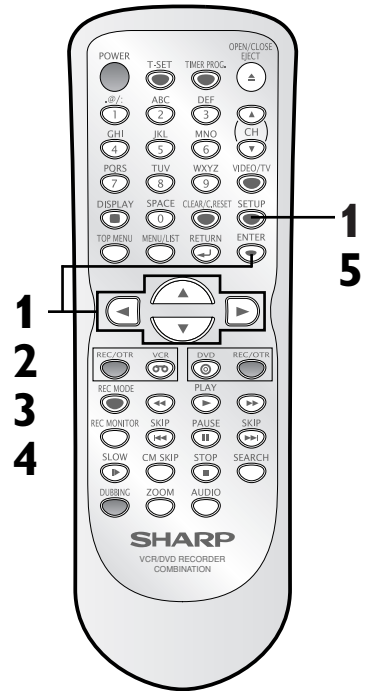

Note

- Deleting a Playlist will not increase the recordable disc space.

Deleting titles



You can delete titles which you no longer need. The recordable disc space will not change. The deleted titles cannot be recovered.

1 Press **SETUP**. Select **“Disc”** using **Cursor ▲ / ▼**, then press **ENTER**.

Disc menu will appear.

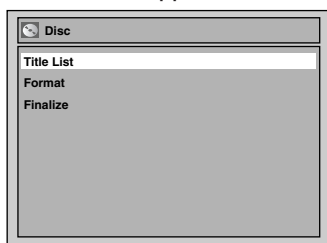

2 Select **“Title List”** using **Cursor ▲ / ▼**, then press **ENTER**.

Title List will appear.

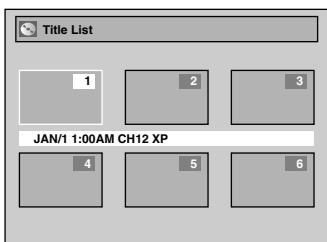

3 Select a desired title using **Cursor ▲ / ▼ / ◀ / ▶**, then press **ENTER**.

Edit menu will appear.

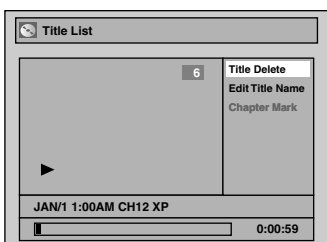

You cannot select **“Chapter Mark”**.

4 Select **“Title Delete”** using **Cursor ▲ / ▼**, then press **ENTER**.

Confirmation window will appear.

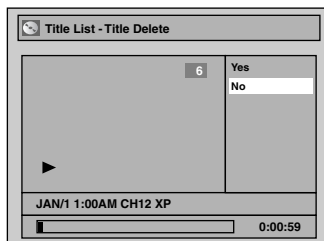

5 Select **“Yes”** using **Cursor ▲ / ▼**, then press **ENTER**.

Title will be deleted.

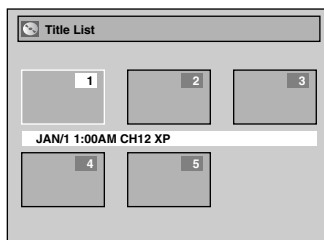

When the only one title is recorded, the Disc menu will not appear after this operation and the unit starts writing the data on the disc automatically.

6 After this operation is completed, press **SETUP** to exit. Writing the data on the disc will start momentarily.

This operation may take a while to be completed.

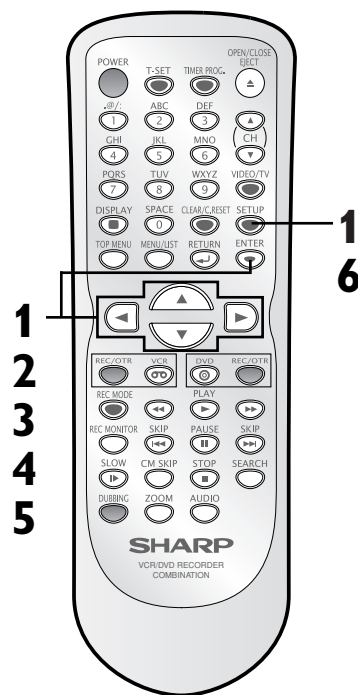

Editing

Editing DVD-R discs (cont'd)

Putting names on titles



You can name the titles and change the names from this menu. The names you put on the titles will be displayed on a Title List.

1

Press **SETUP**. Select “Disc” using Cursor **▲ / ▼**, then press **ENTER**.

Disc menu will appear.



2

Select “Title List” using Cursor **▲ / ▼**, then press **ENTER**.

Title List will appear.

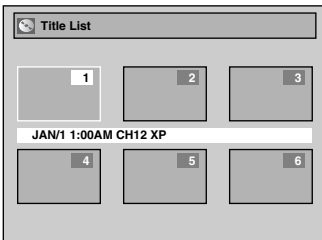

3

Select a desired title using Cursor **▲ / ▼ / ◀ / ▶**, then press **ENTER**.

Edit menu will appear.

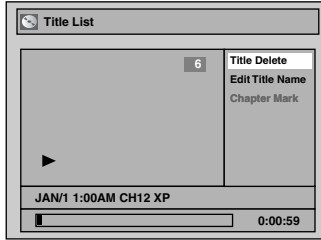

You cannot select “Chapter Mark”.

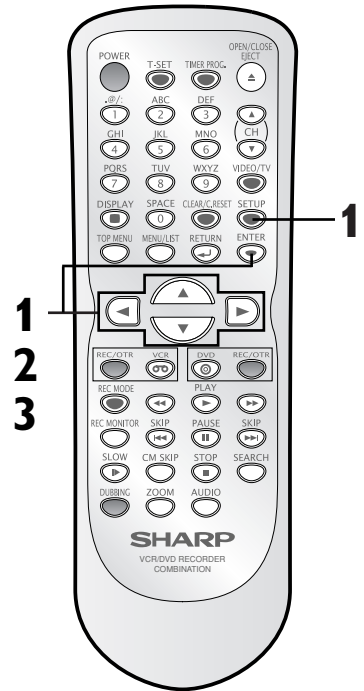

4

Select “Edit Title Name” using Cursor \blacktriangle / \blacktriangledown , then press **ENTER**.

A window for entering a title name will appear.

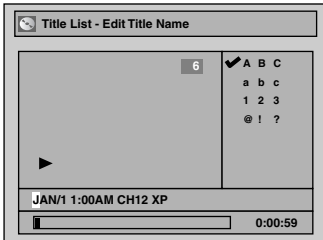

5

To enter a title name, follow the **STEPS** of “Guide to edit title name” on this page.

character set

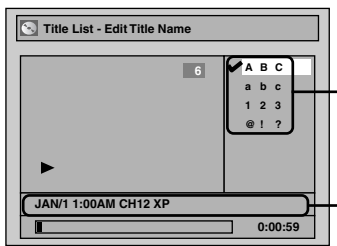

area for entering title names

When you finish entering a title name, press **ENTER**.

Confirmation window will appear.

6

Select “Yes” using Cursor \blacktriangle / \blacktriangledown , then press **ENTER**.

The name you entered will be activated.

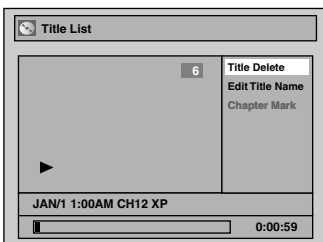

7

After this operation is completed, press **SETUP** to exit.

Writing the data on the disc will start momentarily.

This operation may take a while to be completed.

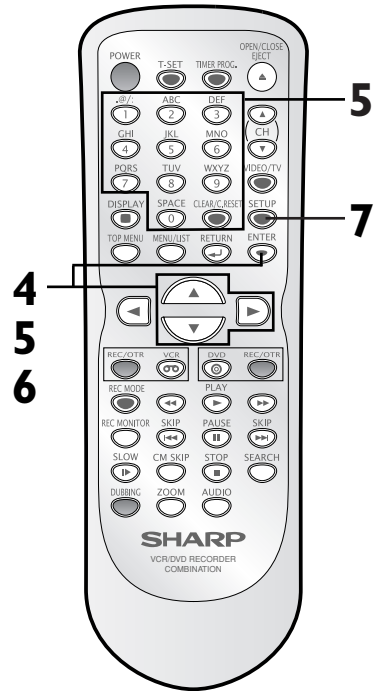

[Guide to edit title name]

[STEP1]: Select a desired character set using Cursor \blacktriangle / \blacktriangledown , then press **ENTER**.

A B C
a b c
1 2 3
@ ! ?

[STEP2]: Follow the list below, press the **Number** buttons repeatedly until the desired letter appears.

e.g. character set : A B C

Select Press	ABC	abc	123	@ ! ?
0	<space>	<space>	0	<space>
1	—	—	1	! " # \$ % & ' () * + , - . / : ; < = > ? @ [] ^ _ { }
2	ABC	abc	2	—
3	DEF	def	3	—
4	GHI	ghi	4	—
5	JKL	jkl	5	—
6	MNO	mno	6	—
7	PQRS	pqrs	7	—
8	TUV	tuv	8	—
9	WXYZ	wxyz	9	—

Note:

Undefined letters in a title name are shown by “*”. If you delete them, adjoining letters may change to “*” or other.

- Character set will be changed to the “@!?” automatically if you press 1 after you selected the “ABC” or “abc” mode.
- If you want to mix different character sets in one title, repeat STEP [1] and [2] above.
- To delete letters, press **CLEAR/C.RESET** repeatedly. Hold **CLEAR/C.RESET** to delete all letters.
- To go on to the next entering area for letters, press **Cursor** \blacktriangleright .
- You can enter up to 30 letters.

Changing the Setting menu

Tour of the Setting menu

The following table shows the items which you can change the settings and their default settings. Refer to the following table for your convenience.

Setting menu	Items (highlight is the default)	Contents	
1. Language setting ➡ Pages 87-88	Disc Menu Language	English French Spanish ⋮	Set the language for disc menu.
	Audio Language	Original English French ⋮	Set the language for audio.
	Subtitle Language	OFF English French ⋮	Set the language for subtitles.
2. Display setting ➡ Pages 89-90	OSD Language	English Français Español	Set the language for OSD (On-Screen Display).
	FL Dimmer	Auto Bright Dark	Set the brightness of front display.
	Screen Saver	OFF 5 minutes 10 minutes ⋮	Set the idling time before the screen saver starts.
3. Audio setting ➡ Pages 91-92	Digital Out	PCM 48kHz 96kHz	Set whether the sound recorded in 96kHz will be down sampled in 48kHz.
		Dolby Digital PCM Stream	Set the type of sound signal output from the digital audio output jack.
		DTS ON OFF	Set whether or not DTS signal will be output.
	Dynamic Range Control	ON OFF	Compress the range of sound volume.
	Fast Forward with Audio	ON OFF	Set whether or not to output sound during fast forward playback.
4. Parental setting ➡ Pages 93-94	Parental Lock	All level 8 to 1	Set the parental level for DVD playback.
	(Change password)	Enter the current four-digit password	Set and change the password.

Note

- If you change the settings in the setting menu, the information of contents stays on even after the power is switched off.
- An item which is not currently available is grayed out in setting menu.

Changing the Setting menu

Language setting

Press **STOP** ■ if you are playing back a disc.

1

Press **SETUP**.

Easy Setting Menu or Advanced Setting Menu will appear.
If Advanced Setting Menu is displayed, proceed to STEP 3.

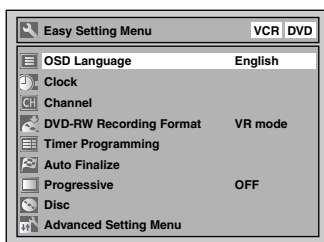

2

Select “Advanced Setting Menu” using Cursor ▲ / ▼, then press **ENTER**.

Advanced Setting Menu will appear.

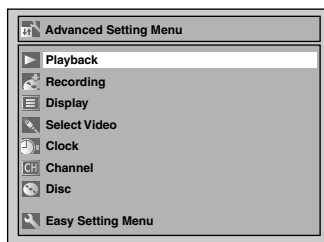

3

Select “Playback” using Cursor ▲ / ▼, then press **ENTER**.

Option window will appear.

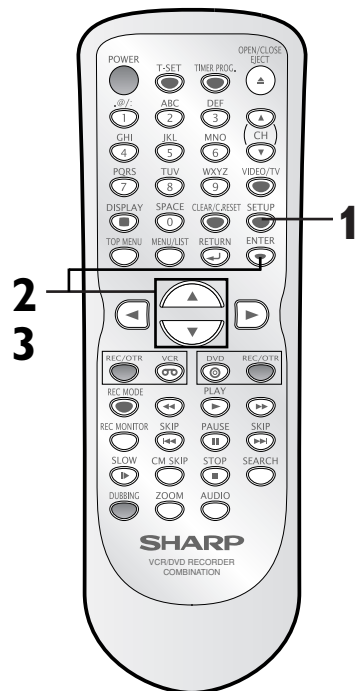
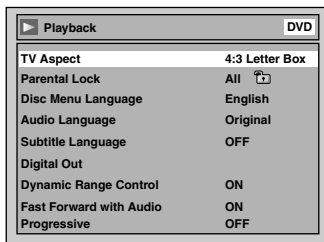

Note

- Only the languages supported by the disc can be selected.
- Audio Language setting may not be available on some discs.
- You can also change or switch off the subtitles on a DVD disc from the disc menu if it is available.

Changing the Setting menu

Language setting (cont'd)

4

Select a desired item using Cursor ▲ / ▼, then press ENTER.

Disc Menu Language (Default : English)

Set the language for Disc Menu.

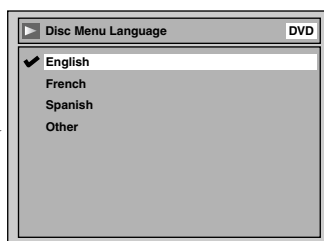
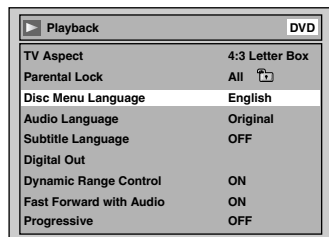

- Select a setting using Cursor ▲ / ▼, then press ENTER.

Your setting will be activated.

Audio Language (Default : Original)

Set the Audio language.

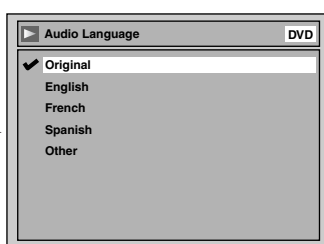
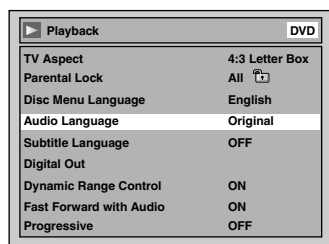

- Select a setting using Cursor ▲ / ▼, then press ENTER.

Your setting will be activated.

- When Original is selected, the audio language will be the disc's default language.

Subtitle Language (Default : OFF)

Set the Subtitle language.

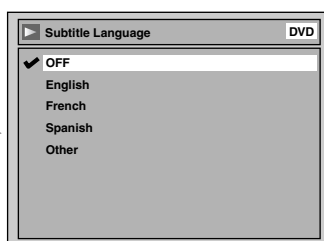
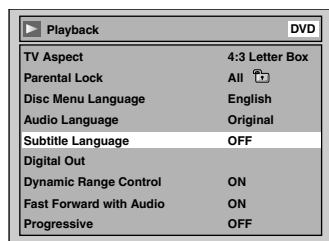

- Select a setting using Cursor ▲ / ▼, then press ENTER.

Your setting will be activated.

If "Other" is selected, press 4-digit code using the Number buttons.

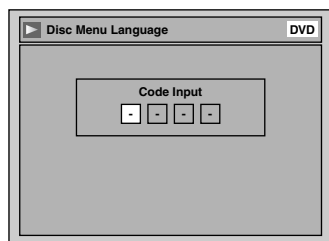

- When you finish entering the code, press ENTER. Refer to the language code table on page 102.

5

Press SETUP to exit.

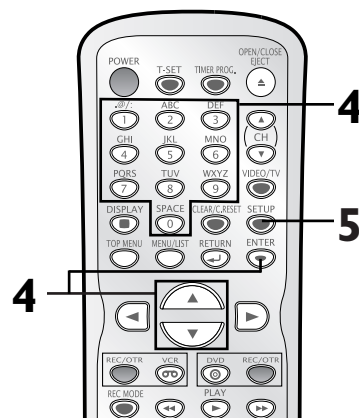

Changing the Setting menu

Display setting

Press **STOP** ■ if you are playing back a disc.

1

Press **SETUP**.

Easy Setting Menu or Advanced Setting Menu will appear.
If Advanced Setting Menu is displayed, proceed to STEP 3.

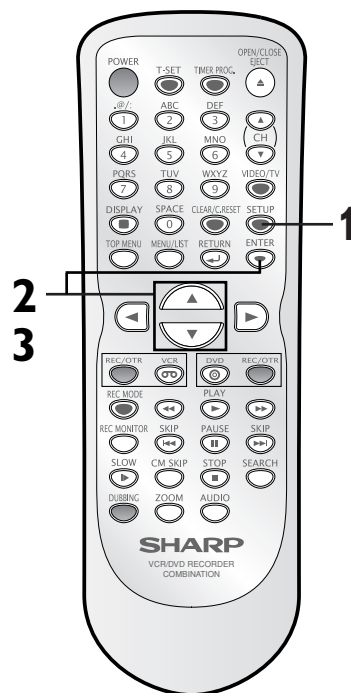
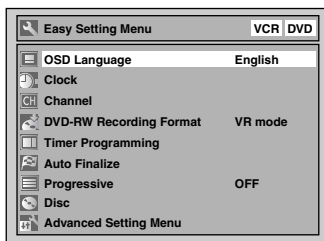

2

Select “Advanced Setting Menu” using Cursor ▲ / ▼, then press **ENTER**.

Advanced Setting Menu will appear.

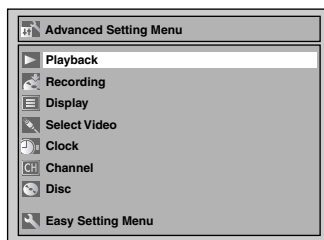

3

Select “Display” using Cursor ▲ / ▼, then press **ENTER**.

Option window will appear.

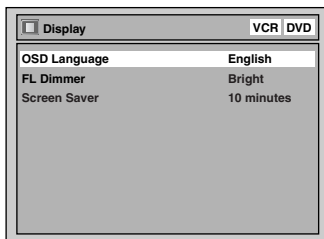

Changing the Setting menu

Display setting (cont'd)

4

Select a desired item using Cursor \blacktriangle / \blacktriangledown , then press ENTER.

OSD Language (Default : English) SKIP 2 and 3

Set the language for OSD (On-Screen Display).

You can also choose this setting from the Easy Setting Menu.

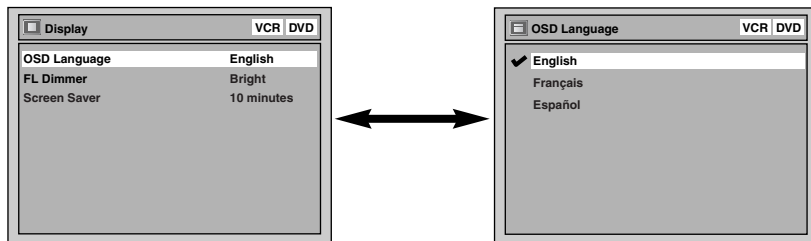

- Select a setting using Cursor \blacktriangle / \blacktriangledown , then press ENTER.

Your setting will be activated.

FL Dimmer (Default : Bright)

Set the brightness of front display.

You can choose one among "Auto", "Bright" and "Dark".

If "Auto" is selected, the display will be shown brighter when the power is on, and darker when the power is off.

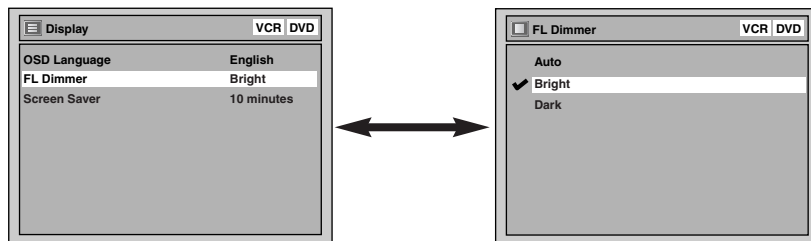

- Select a setting using Cursor \blacktriangle / \blacktriangledown , then press ENTER.

Your setting will be activated.

Screen Saver (Default : 10 minutes)

This feature displays simplified animation on the screen to prevent the screen of your TV from getting burned. Screen saver will be activated automatically when the unit is left untouched for a certain amount of time with some screens such as; Easy Setting Menu, Advanced Setting Menu or Timer Programming list displayed on the screen. You can set the idling time before the screen saver's activation. If you select "OFF", the screen saver is not effective.

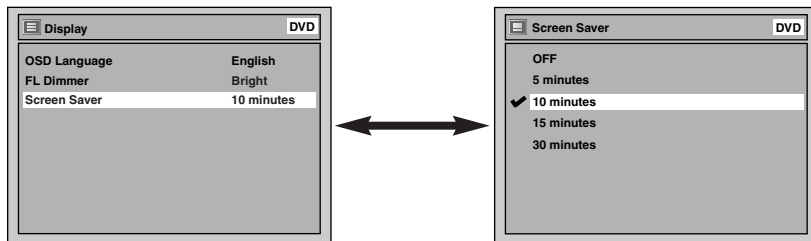

- Select a setting using Cursor \blacktriangle / \blacktriangledown , then press ENTER.

Your setting will be activated.

5

Press SETUP to exit.

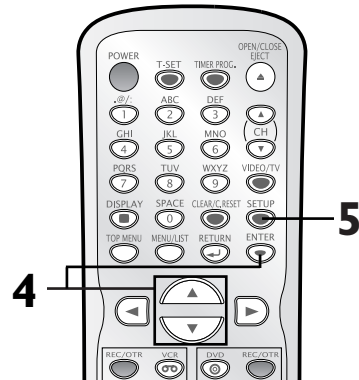

Changing the Setting menu

Audio setting

Choose the appropriate Audio settings for your equipment.

Press **STOP** ■ if you are playing back a disc.

1
Press **SETUP**.

Easy Setting Menu or Advanced Setting Menu will appear.
If Advanced Setting Menu is displayed, proceed to STEP 3.

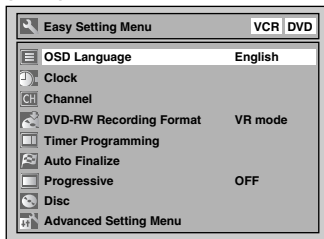

2
Select “Advanced Setting Menu” using Cursor ▲ / ▼, then press **ENTER**.

Advanced Setting Menu will appear.

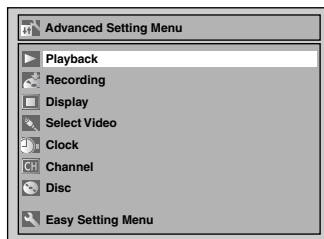

3
Select “Playback” using Cursor ▲ / ▼, then press **ENTER**.
Option window will appear.

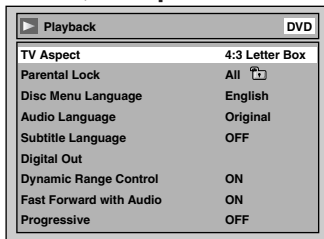

4
Select a desired item using Cursor ▲ / ▼, then press **ENTER**.

Digital Out

Set the digital audio output.

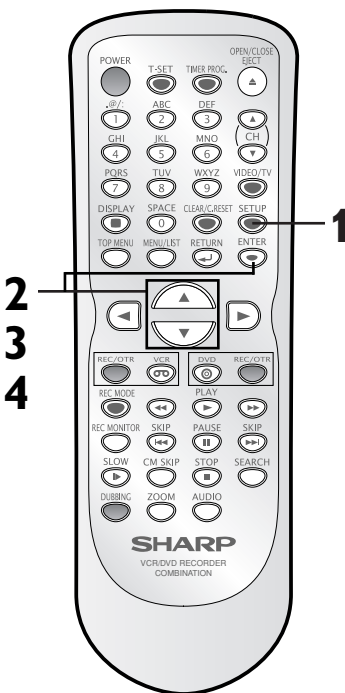
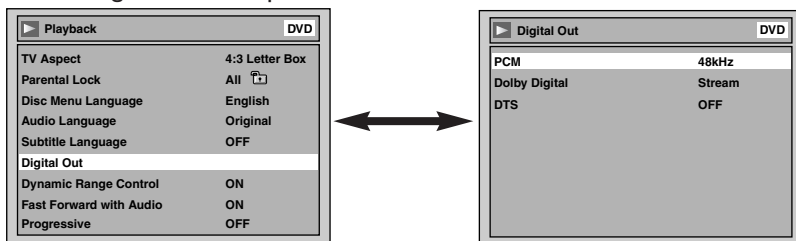

Note

- Dynamic Range Control function is available only on the discs which are recorded in the Dolby Digital format.

• Select a setting using Cursor ▲ / ▼, then press **ENTER**.

Option window will appear.
Proceed to STEP A, B or C.

Instructions continue on page 92

Changing the Setting menu

Audio setting (cont'd)

A Settings for PCM (Default : 48kHz)

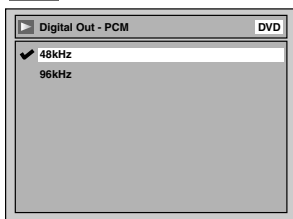

• Select a setting using Cursor ▲ / ▼, then press ENTER.

Your setting will be activated.

48kHz : If your amplifier/decoder is NOT compatible with 96kHz PCM, select "48kHz". 96kHz sound will be output in 48kHz.

96kHz : If your amplifier/decoder is compatible with 96kHz PCM, select "96kHz". 96kHz sound will be output.

Note
.....
When playing back disc with copyright protection

• Even if you select "96kHz", the sound will be down sampled at 48kHz.

B Settings for Dolby Digital (Default : Stream)

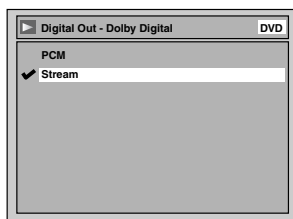

• Select a setting using Cursor ▲ / ▼, then press ENTER.

Your setting will be activated.

PCM : Convert the Dolby Digital into PCM (2 channel).

When your amplifier/decoder is NOT compatible with Dolby Digital, set to "PCM".

Stream : Outputs Dolby Digital signals.

When your amplifier/decoder is compatible with Dolby Digital, set to "Stream".

Note
.....
When playing back a DVD-RW disc recorded in VR mode

• If the audio on a disc is recorded in Dolby Digital format, set "Dolby Digital" to "PCM" so that you can switch to main (L), sub audio (R), or a mix of both (L/R) with your amplifier/decoder.

C Settings for DTS (Default : OFF)

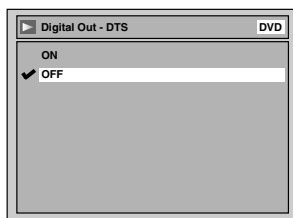

• Select a setting using Cursor ▲ / ▼, then press ENTER.

Your setting will be activated.

ON : Outputs DTS signals.

When your amplifier/decoder is compatible with DTS, set to "ON".

OFF : No DTS signal is output.

When your amplifier/decoder is NOT compatible with DTS, set to "OFF".

Dynamic Range Control (Default : ON)

Set to "ON" to compress the range between soft and loud sounds.

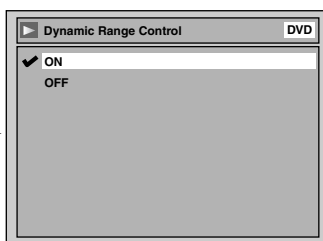
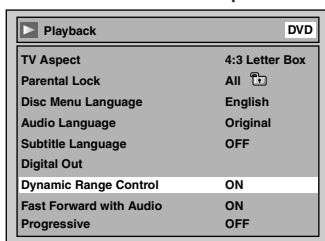

• Select a setting using Cursor ▲ / ▼, then press ENTER.

Your setting will be activated.

Fast Forward with Audio (Default : ON)

Set to "ON" to output the sound during playback in x1.5 fast forward.

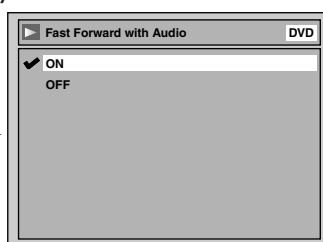
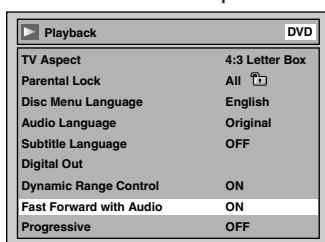

• Select a setting using Cursor ▲ / ▼, then press ENTER.

Your setting will be activated.

5

Press SETUP to exit.

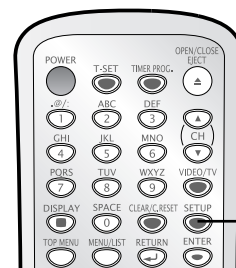

5

Changing the Setting menu

Settings for Parental lock level

Some DVD-Video discs feature a Parental Lock level. Playback will stop if the disc's general rating exceeds the level you set. It will require you to enter a password before the disc will be played back. This feature prevents your children from viewing inappropriate materials.

Press **STOP** ■ if you are playing back a disc.

1

Press **SETUP**.

Easy Setting Menu or Advanced Setting Menu will appear.
If Advanced Setting Menu is displayed, proceed to STEP 3.

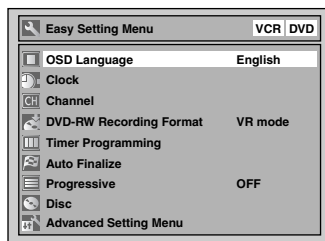

2

Select "Advanced Setting Menu" using Cursor ▲ / ▼, then press **ENTER**.

Advanced Setting Menu will appear.

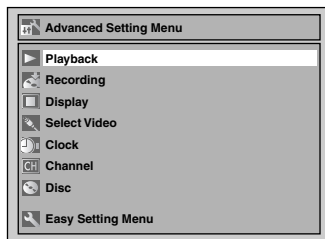

3

Select "Playback" using Cursor ▲ / ▼, then press **ENTER**.

Option window will appear.

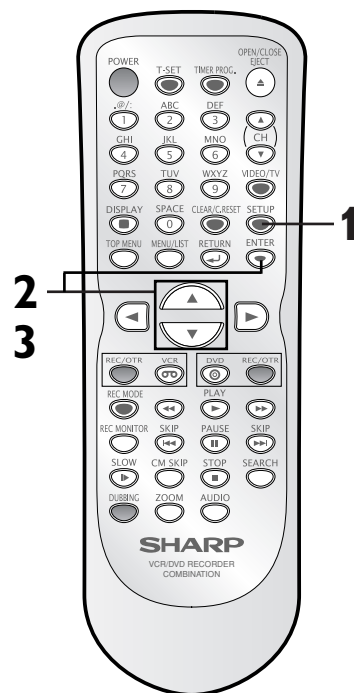
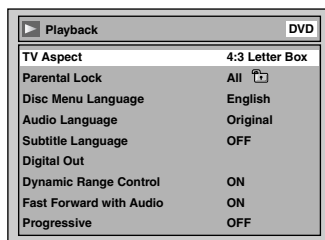

Note

- Parental lock function may not be available on some discs.
- For some DVDs, it may be difficult to find if they are compatible with parental lock. Be sure to check if the parental lock function operates in the way that you have set.
- Record the password in case you forget it.

Changing the Setting menu

Settings for Parental lock level (cont'd)

4

Select "Parental Lock" using Cursor \blacktriangle / \blacktriangledown , then press ENTER.

Parental Lock (Default :All)

Set the Parental Lock level.

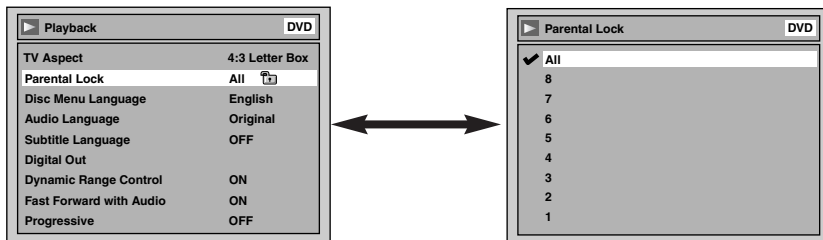

• Change the parental level using Cursor \blacktriangle / \blacktriangledown , then press ENTER.

Option window will appear. Proceed to STEP A or B.

A

A password has not been set yet

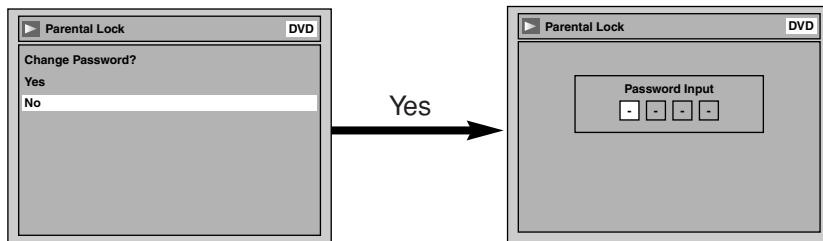

• Select "Yes" using Cursor \blacktriangle / \blacktriangledown , then enter a new password (except for 4, 7, 3, 7) using the Number buttons, then press ENTER.

Your setting will be activated.

• If you select "No", proceed to STEP 5.

B

A password has been set already

Change the password

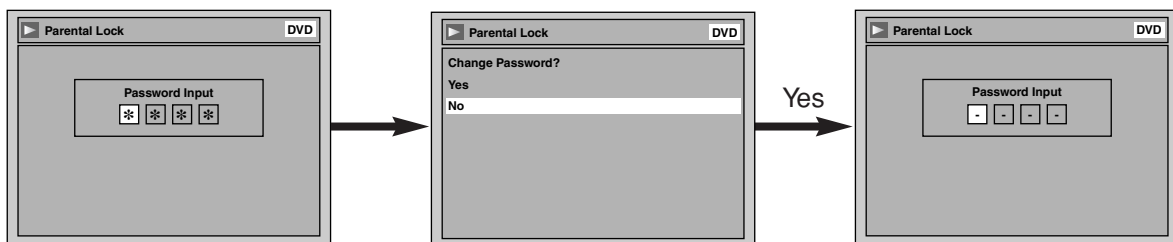

• Enter the current password using the Number buttons.

• If you want to change the password select "YES".
• If you don't need to change the password, select "No", and proceed to STEP 5.

• Select "Yes" using Cursor \blacktriangle / \blacktriangledown , then enter a new password (except for 4, 7, 3, 7) using the Number buttons, then press ENTER. Your setting will be activated.

5

Press SETUP to exit.

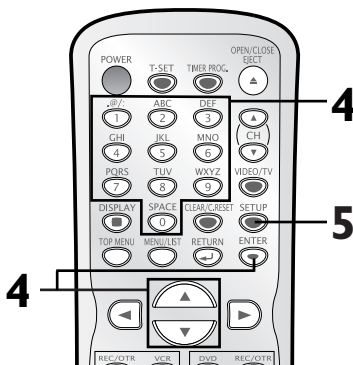

Note

• Press **CLEAR/C.RESET** to erase numbers entered incorrectly.
• When you forget the password or you want to clear all settings in Parental lock, enter 4, 7, 3, 7 using the Number buttons in input window at STEP B. Password will be cleared and parental levels will be set to All.

VCR functions

Playback



1

Press **POWER** on the remote control or the front panel of the unit.

When you are playing a videotape, turn the TV on and be sure to select the input to which the unit is connected.



2

Insert a prerecorded videotape, then press **PLAY** ► to begin playback.

3

During playback, press **PAUSE** II .

Playback will pause and sound will be muted.

4

Press **PLAY** ► to resume playback.

5

Press **STOP** ■ to stop playback.

6

Press **OPEN/CLOSE/EJECT** ▲ (or **STOP/EJECT** ■ / ▲ on the front panel of the unit) to eject the videotape.

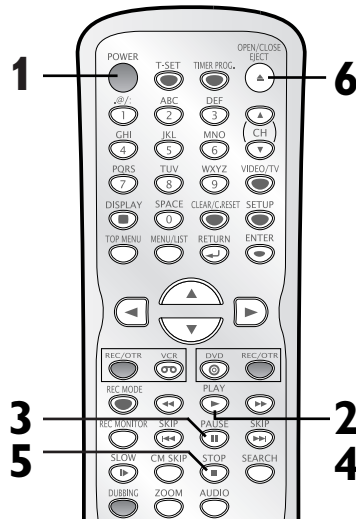

Note

- When a videotape without erase-protection tab is inserted, the unit will start playback automatically.
- Tracking will be automatically adjusted upon playback. To adjust the tracking manually, press **CHANNEL** ▲ / ▼ on the front panel of the unit or **CH** ▲ / ▼ on the remote control.

Recording and One-touch Timer Recording

Recording



Before recording, make sure:

- The desired channel is selected by pressing the **Number buttons** or **CH** ▲ / ▼ on the remote control or **CHANNEL** ▲ / ▼ on the front panel of the unit.
- A videotape with an erase-protection tab is in the unit.
- The desired recording speed is selected in SP (standard playback) or SLP (super long playback) mode by pressing **REC MODE** on the remote control.

Recording speed:

Tape speed	Recording/Playback Time		
Type of tape	T60	T120	T160
SP mode	1hour	2hours	2-2/3hours
SLP mode	3hours	6hours	8hours

- Stereo or SAP is selected. Refer to page 21.
- Refer to pages 35-39 for instructions on Timer Recording.



1

Press **REC/OTR** to begin the recording.

To temporarily stop recording or to resume it, press **PAUSE** II . After the unit has been in Pause mode for 5 minutes, it will stop automatically to protect the videotape and the video head from damage.

2

Press **STOP** ■ when the recording is completed.

Accidental erasure prevention

To prevent accidental recording on a recorded videotape, remove its erase-protection tab. To record on it later, cover the hole with cellophane tape.

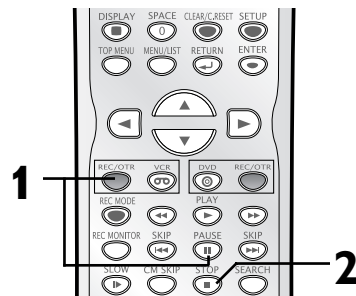
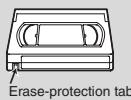

Note

- To view one channel while recording another
 - 1) While you are recording on one channel, press **VIDEO/TV**.
 - 2) At the cable box or satellite box, select the channel you want to view.
 If you have connected the unit to a cable box or satellite box, refer to "Connection to a cable box or satellite box" section on page 15.

VCR functions

Recording and One-touch Timer Recording (cont'd)

One-touch Timer Recording



This feature allows you to set the recording length simply by pressing **REC/OTR** on the remote control or the front panel of the unit.



1

During normal recording, press **REC/OTR** to begin one-touch timer recording.

You can select a fixed recording time by pressing **REC/OTR** repeatedly.

1

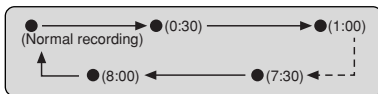
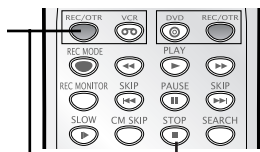

When one-touch timer recording is finished, the unit will turn off automatically.

To change the recording length during the one-touch timer recording, press **REC/OTR** repeatedly until the desired length appear.

To cancel the one-touch timer recording within the specified time, press **STOP**.

Note

- The remaining recording time will appear on the display panel during an one-touch timer recording. Press **DISPLAY** to see it on the TV screen.
- You cannot pause a one-touch timer recording.
- If OTR is finished in VCR during playback or REC mode in DVD, the VCR will be in STOP mode and the DVD keeps the current mode.
- Unlike a timer recording, you can perform the following operations during a one-touch timer recording.
 - Turning the power off.
 - Using **REC/OTR** or **STOP**.
- When OTR is finished and the power is turned off, the unit will switch to the standby mode automatically if a Timer Recording has been programmed. Press **T-SET** to cancel the standby mode for using the unit continuously.

Search

Index search



An index mark will be assigned at the beginning of each recording you make. You may skip to a specific marked point by following the steps below.



1

Press **SEARCH** so that the index search menu appears.

2

Enter the number of recordings you wish to skip using the Number buttons within 30 seconds.

INDEX SEARCH
03

3

Press **◀▶** to start index search.

If you want to go in the forward direction, press **▶▶**.

If you want to go in the reverse direction, press **◀◀**.

After index search, the VCR will play the videotape automatically.

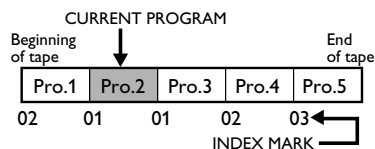

2

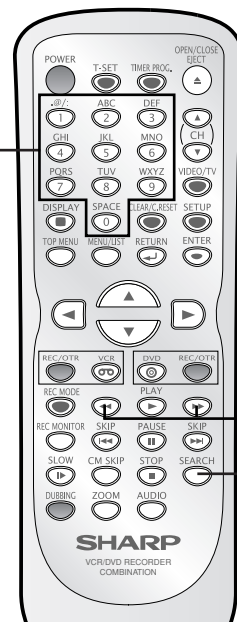

Note

- Every time a videotape is recorded, an index mark is written on the videotape.
- You can make the index mark up to 20.

VCR functions

Search (cont'd)

Time search



This feature allows you to go to a specific point on a videotape by entering the exact amount of time you wish to skip in order to reach the point.

press first.

1

Press **SEARCH** repeatedly so that the Time search menu appears.

2

Enter your desired time to skip using the **Number** buttons within **30** seconds.

You can set the time up to 9:59.

TIME SEARCH
2:50

3

Press **◀◀ / ▶▶** to start time search.

If you want to go in the forward direction, press **▶▶**.

If you want to go in the reverse direction, press **◀◀**.

After time search, the unit will play the videotape automatically.

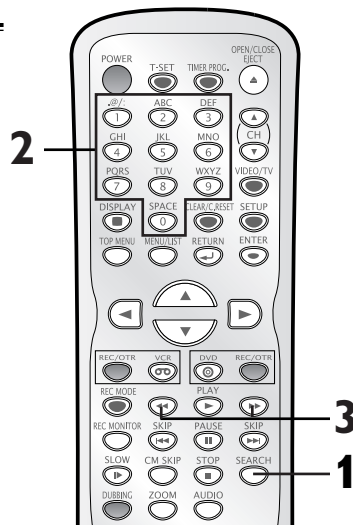

Note

- These functions are not available during recording.
- Press **STOP** to stop the search.
- If the end of the videotape is reached during a Search, this unit will cancel the search and rewind the videotape.

Other operations



press first.

Fast forward:

When the unit is in stop mode, press **▶▶** to fast forward the videotape.

Rewind:

When the unit is in stop mode, press **◀◀** to rewind the videotape.

To cue or review picture during playback (Picture Search):

Press **◀◀ / ▶▶** during playback.

Press it again and the unit will search in super high speed. (in the SLP mode only)

To freeze the picture on TV screen during playback (Still mode):

Press **PAUSE** . Each time you press the button, the picture will be forwarded by one frame.

- If the picture begins to vibrate vertically during the still mode, stabilize the picture by pressing **CHANNEL** / or **CH** / .
- If the picture is distorted or rolling vertically, adjust the vertical hold control on your TV, if equipped.

Counter Reset:

Press **CLEAR/C.RESET**.

To play back in slow motion:

Press **SLOW** during playback or the still mode.

- If the noise bars appear on the TV screen, you can reduce it by pressing **CHANNEL** / or **CH** / .

Automatic Rewind:

When a videotape is played or fast forwarded to its end, the videotape will rewind to the beginning, stop, and eject itself.

When you play back a videotape recorded in Hi-Fi stereo:

Press **AUDIO** on the remote control to select Hi-Fi or MONO for playback sound mode.

- If you have connected a stereo TV to this unit, select "Hi-Fi".
- If you have connected a monaural TV to this unit, select "MONO".

Your Selection	Hi-Fi		MONO
	L-channel	R-channel	
non Hi-Fi tapes	Monaural	Monaural	Monaural
Hi-Fi tapes recorded in Hi-Fi stereo	L	R	L+R
Hi-Fi tapes recorded main audio program	Main audio program	Main audio program	Main audio program
Hi-Fi tapes recorded second audio program	Second audio program	Second audio program	Second audio program

Note

- Still/Slow/Pause mode will be automatically canceled after 5 minutes to prevent damage to the videotape and the video head.
- To return to playback from the Picture Search/Still/Slow mode, press **PLAY** .

Troubleshooting

Before requesting service for this unit, check the table below for a possible cause of the problem you are experiencing. Some simple checks or a minor adjustment on your part may eliminate the problem and restore proper operation.

Symptom	Remedy
The power does not turn on.	<ul style="list-style-type: none"> • Check that the AC power cord is connected securely. • (In case of power failure) Check the breaker. • Press T-SET to cancel the timer standby mode.
There is no picture.	<ul style="list-style-type: none"> • Re-connect the connecting cord securely. • The connecting cords are damaged. • Check the connection to your TV (page 14). • Check the RF output channel when you view a TV program using RF connection. • Switch the input selector on your TV (such as to "LINE1") so that the signal from this unit appears on the TV screen.
TV program reception does not fill the screen.	<ul style="list-style-type: none"> • Try to set the channels with "Auto Preset" in the setting menu (page 19). • Select a channel of any TV program using CH ▲ / ▼ buttons. • Press VIDEO/TV if necessary.
TV program pictures are distorted.	<ul style="list-style-type: none"> • Adjust TV antenna. • Adjust the picture (see the TV's instruction manual). • Place the unit and TV farther apart. • Place the TV and any bunched antenna cables farther apart.
TV channels cannot be changed.	<ul style="list-style-type: none"> • Switch the input to TV. • Connect the antenna cable correctly (page 14).
Playback picture is distorted.	<ul style="list-style-type: none"> • Keep the equipment which may cause electrical disturbances, such as a cellular phone, away.
The playback picture or TV program from the equipment connected through the unit is distorted.	<ul style="list-style-type: none"> • If the playback picture output from a DVD player, VCR, or tuner goes through the unit before reaching your TV, the copy-protection signal applied to some programs could affect picture quality. Disconnect the playback equipment in question and connect it directly to your TV.
There is no sound.	<ul style="list-style-type: none"> • Re-connect all connections securely. • The connecting cord is damaged. • Check the connections to the amplifier input. • The input source setting on the amplifier is incorrect. • The unit is in pause mode or in Slow-motion Playback mode. • The unit is in fast forward or fast reverse mode.
The channel cannot be changed from the channel you are recording.	<ul style="list-style-type: none"> • Set the TV's input to "TV".
Nothing was recorded even though you set the timer setting correctly.	<ul style="list-style-type: none"> • There was a power failure during recording. • The internal clock of the unit stopped due to a power failure that lasted for more than 30 seconds. Reset the clock (pages 22-24). • Disconnect the AC power cord from the AC outlet, and connect it again. • The program contains copy protection signals that restricts copying. • The timer setting overlapped with another setting that was set later or has priority (page 39).
Timer recording is not completed or did not start from the beginning.	<ul style="list-style-type: none"> • The timer setting overlapped with another setting that was set later or has priority (page 39). • Disc space was not enough or tape reaches the end.
Timer recording is impossible.	<ul style="list-style-type: none"> • Make sure indicator appears on the front display of this unit. If not, press T-SET.
The remote control does not function.	<ul style="list-style-type: none"> • Batteries are weak. • There are obstacles between the remote control and the unit. • The remote control is far from the unit. • There are no batteries in the remote. • Turn on the unit. • The remote control is not pointed at the remote sensor on the unit. • Press DVD or VCR, whichever you need. Then, try again. • Press T-SET to cancel the timer standby mode. • If above remedies do not solve the problem, please call the Service Center for help.
The unit does not operate properly.	<ul style="list-style-type: none"> • When static electricity, etc., causes the unit to operate abnormally, unplug the unit and then plug it again.

Troubleshooting (cont'd)

Symptom	Remedy
There is no picture.	<ul style="list-style-type: none"> The Setup Display appears. Press SET UP or RETURN \leftarrow to turn off the display. Check if the INTERLACE/PROGRESSIVE mode is set correctly (page 14).
Picture noise appears.	<ul style="list-style-type: none"> The disc is dirty or flawed. If the picture output signal from the unit passes through your VCR before reaching your TV, or if you are connected to a combination TV/VIDEO player, the copy-protection signal applied to some DVD programs could affect picture quality. If you still experience this problem even when you connect the unit directly to your TV, try connecting the unit to your TV's S-VIDEO input.
There is no sound.	<ul style="list-style-type: none"> If the audio signal does not come through the DIGITAL AUDIO OUT (COAXIAL) jack, check the Audio Setup settings (page 16). The disc is dirty or flawed.
Sound is noisy.	<ul style="list-style-type: none"> The disc is dirty or flawed.
This unit does not play back the disc.	<ul style="list-style-type: none"> No disc is inserted. A blank disc is inserted. The disc is upside down. Insert the disc with the labeled side facing up. The disc is not correctly inserted. The unit cannot play back certain discs (such as a CD-ROM) (page 46). The region code on the DVD-Video does not match the ones on the unit (page 46). Moisture has condensed inside the unit. Remove the disc and leave the unit turned on for about two hours until the moisture evaporates (page 4). If the disc was recorded on another recorder, the unit cannot play back the disc unless it is finalized (page 44).
Playback image freezes for a second.	<ul style="list-style-type: none"> During the playback of two layered disc, picture may freeze for a moment when the 1st layer switches to the 2nd layer. This is not a malfunction.
The disc does not start playback from the beginning.	<ul style="list-style-type: none"> Resume playback was activated (page 51). Press STOP \blacksquare twice. You have inserted a disc whose Title menu or DVD menu automatically appears on the TV screen when it is inserted for the first time.
The unit starts playing back the disc automatically.	<ul style="list-style-type: none"> The DVD-Video features an auto playback function.
Some functions such as Stop, Search, or Slow-motion Playback cannot be performed.	<ul style="list-style-type: none"> Depending on the disc, you may not be able to do some of these operations. See the instruction manual supplied with the disc.
The language for the sound track cannot be changed.	<ul style="list-style-type: none"> Multilingual tracks are not recorded on DVD-RW or DVD-R being played back. The DVD-Video prohibits the changing of the language for the sound track. Try changing the language using the DVD-Video's menu.
The subtitle language cannot be changed or turned off.	<ul style="list-style-type: none"> Multilingual subtitle are not recorded on the DVD-Video. The DVD-Video prohibits changing of the subtitles. Try changing the subtitles using the DVD-Video's menu.
The angles cannot be changed.	<ul style="list-style-type: none"> Multi-angles are not recorded on the DVD-Video being played back. The angle-change operation is possible as long as the disc contains a multi-angle portion. Actual change can be performed when the portion has come up. The DVD-Video prohibits changing angles. Try changing the angles using the DVD-Video's menu.
Recording does not stop immediately after you press STOP \blacksquare .	<ul style="list-style-type: none"> It will take a few seconds for the unit to input disc data before recording can stop.
Recording does not start immediately after you press REC/OTR .	<ul style="list-style-type: none"> An unused DVD-RW or DVD-R was inserted. It takes a while for the unit to automatically format a DVD-RW.

Others

Troubleshooting (cont'd)

	Symptom	Remedy
DVD	The disc tray does not open when you press OPEN/CLOSE ▲.	<ul style="list-style-type: none"> It may take a few seconds for the disc tray to open after you have recorded or edited a disc. This is because the unit is adding disc data to the disc.
	“Repairing” appears on the display. 	<ul style="list-style-type: none"> If there is a power failure or unplugging during recording, finalizing, formatting or editing, a Repairing process will begin automatically soon after turning the unit on again. It may take several minutes up to about four hours.
VCR	Picture noise appears.	<ul style="list-style-type: none"> Head cleaning for VCR may be necessary. Refer to “AUTO HEAD CLEANING” (page 5). Adjust tracking control for better picture by pressing CHANNEL ▲/▼ on this unit or CH ▲/▼ while you are playing a videotape.
	The tape does not play.	<ul style="list-style-type: none"> No videotape is inserted.
	Recording does not start immediately after you press REC/OTR .	<ul style="list-style-type: none"> Make sure the videotape has a record tab when you record to a videotape. If needed, cover the hole with cellophane tape.
	The remote control does not function.	<ul style="list-style-type: none"> Check if a videotape is in this unit.
	The motor rotates even when playback / recording is stopped.	<ul style="list-style-type: none"> The motor may rotate for the duration of approximately 5 minutes for efficient operation. This is not a malfunction.

Error message	Cause	Solution
Disc Error — Please eject the disc. — Playback feature may not be available on this Disc.	Unplayable disc is inserted in the unit. The disc is upside down.	Insert the standardized disc which bears the marks on page 46. Insert the disc with the labeled side facing up.
Region Error — Please eject the disc. — Playback is not authorized in your region.	The region of the DVD-Video disc does not match the ones on the unit.	Insert the DVD-Video disc with region code 1 or ALL.
Parental Lock On — Please eject the disc. — The current selected parental level prohibits playback.	The current selected parental level in the setting menu prohibits playback.	Check the “Parental Lock” setting (pages 93-94).
Recording Error This program is not allowed to be recorded.	The recording function encountered a copy prohibited program.	You cannot record copy prohibited programs.
Recording Error This program is not recordable in Video mode.	You are trying to record a copy-once program on the DVD-RW disc in Video mode.	Set “DVD-RW Recording Format” to “VR mode” (page 28).
Recording Error Can not record on this disc.	You are trying to record on the disc which is unrecordable, or the disc status is unable to record. The disc is dirty. The disc is damaged.	Insert a recordable disc, and ensure the disc status satisfies the recording requirements (pages 26-27). Clean the disc with a cleaning cloth. Replace the disc.
Recording Error This program is not allowed to be recorded on this disc.	You are trying to record a copy-once program on the DVD-RW disc which is not compatible with CPRM.	Insert a ver.1.1 or 1.2 CPRM compatible DVD-RW disc.
Recording Error This disc is protected and not recordable.	You are trying to record on the protected disc.	Cancel the disc protect setting in the Disc setting menu (page 41).
Recording Error Disc is full. (No area for new recording)	You are trying to record on the disc with no recording space left.	Insert the recordable disc with enough recording space.

Troubleshooting (cont'd)

Error message	Cause	Solution
Recording Error You cannot record more than 99 titles on one disc. (The maximum is 99)	You are trying to record on the disc on which the number of recording titles already reached the maximum (99).	Delete unnecessary titles (pages 65, 69).
Recording Error You cannot record more than 999 chapters on one disc. (The maximum is 999)	You are trying to record on the VR mode DVD-RW disc on which the number of recording chapters already reached the maximum (999).	This unit cannot delete the original chapter. Delete unnecessary chapter marker using other DVD recorders. Delete unnecessary titles from the Original (page 69).
Recording Error You cannot record on this disc as Control Information is full.	This disc has no space to write the Control Information when recording or deleting contents. When editing has been repeatedly performed, the control Information area may become full even if the recording area still has enough space.	Delete unnecessary titles (pages 65, 69).
Recording Error You cannot record on the disc as Power Calibration Area is full.	When recordings are performed repeatedly on an unstable disc, this area may become full. Every time you insert a disc for recording, the disc's working area will be taken up. And if you repeat this frequently, it will be used up sooner and you may not be able to record full 99 titles.	Insert a new disc.
Recording Error This disc is already finalized.	You are trying to record on the disc already finalized.	Undo finalizing of the disc (page 44).

* If you are still having trouble with this unit after checking Troubleshooting, write down the error code and the error description, and call a SHARP Authorized Service Center for inspection. (See **Service Information** on page 104.)

RF converter output

You can watch the TV programs with the tuner of the unit. (Usually channel 3 or 4 of the TV is available for the RF converter setting.) Be sure to connect the unit to a TV using the Round Coaxial cable. Refer to page 14.

1
Select channel 3 on your TV.

2
Press **VIDEO/TV** on the remote control.

• If noise appears, change the RF output channel of the unit to CH 4 by pressing **VIDEO/TV** for 3 seconds. The RF output channel will alternate between CH3 and CH4 as follows.

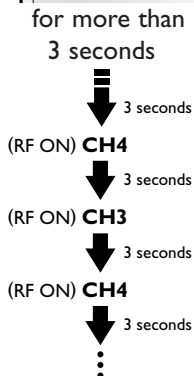
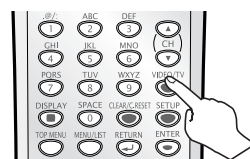

• Every time the RF output channel is changed, CH3 or CH4 will appear on the front panel display.

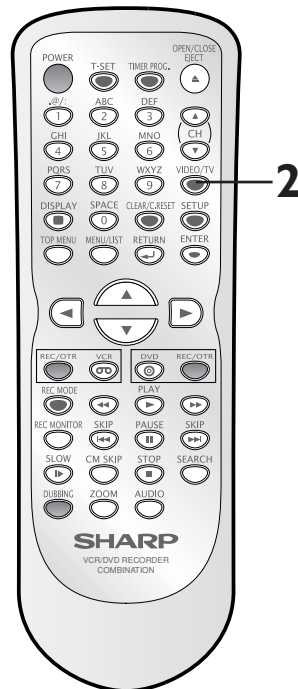

Others

Language code

Language	Code
(Afan) Oromo	6159
Abkhazian	4748
Afar	4747
Afrikaans	4752
Albanian	6563
Amharic	4759
Arabic	4764
Armenian	5471
Assamese	4765
Aymara	4771
Azerbaijani	4772
Bashkir	4847
Basque	5167
Bengali; Bangla	4860
Bhutani	5072
Bihari	4854
Bislama	4855
Breton	4864
Bulgarian	4853
Burmese	5971
Byelorussian	4851
Cambodian	5759
Catalan	4947
Chinese	7254
Corsican	4961
Croatian	5464
Czech	4965
Danish	5047
Dutch	6058
English	5160
Esperanto	5161
Estonian	5166
Faroese	5261
Fiji	5256
Finnish	5255
French	5264
Frisian	5271
Galician	5358
Georgian	5747
German	5051
Greek	5158
Greenlandic	5758
Guarani	5360
Gujarati	5367
Hausa	5447
Hebrew	5569

Language	Code
Hindi	5455
Hungarian	5467
Icelandic	5565
Indonesian	5560
Interlingua	5547
Interlingue	5551
Inupiak	5557
Irish	5347
Italian	5566
Japanese	5647
Javanese	5669
Kannada	5760
Kashmiri	5765
Kazakh	5757
Kinyarwanda	6469
Kirghiz	5771
Kirundi	6460
Korean	5761
Kurdish	5767
Laothian	5861
Latin	5847
Latvian; Lettish	5868
Lingala	5860
Lithuanian	5866
Macedonian	5957
Malagasy	5953
Malay	5965
Malayalam	5958
Maltese	5966
Maori	5955
Marathi	5964
Moldavian	5961
Mongolian	5960
Nauru	6047
Nepali	6051
Norwegian	6061
Occitan	6149
Oriya	6164
Panjabi	6247
Pashto; Pushto	6265
Persian	5247
Polish	6258
Portuguese	6266
Quechua	6367
Rhaeto-Romance	6459
Romanian	6461

Language	Code
Russian	6467
Samoan	6559
Sangho	6553
Sanskrit	6547
Scots Gaelic	5350
Serbian	6564
Serbo-Croatian	6554
Sesotho	6566
Setswana	6660
Shona	6560
Sindhi	6550
Singhalese	6555
Siswat	6565
Slovak	6557
Slovenian	6558
Somali	6561
Spanish	5165
Sundanese	6567
Swahili	6569
Swedish	6568
Tagalog	6658
Tajik	6653
Tamil	6647
Tatar	6666
Telugu	6651
Thai	6654
Tibetan	4861
Tigrinya	6655
Tonga	6661
Tsonga	6665
Turkish	6664
Turkmen	6657
Twì	6669
Ukrainian	6757
Urdu	6764
Uzbek	6772
Vietnamese	6855
Volapuk	6861
Welsh	4971
Wolof	6961
Xhosa	7054
Yiddish	5655
Yoruba	7161
Zulu	7267

Analog audio

An electrical signal that directly represents sound. In contrast, digital audio can be an electrical signal, but is an indirect representation of sound. See also Digital audio.

Aspect ratio

The width of a TV screen relative to its height. Conventional TVs are 4:3 (in other words, the screen is almost square); widescreen models are 16:9 (the screen is almost twice as wide as it is high).

Chapter

Just as a book is split up into several chapters, a title on a DVD disc is usually divided into chapters. See also Title.

Component video output

This is a video signal format that conveys each of three principal colors of light (red, blue and green) through different signal lines. This allows the viewers to experience picture colors as original as it is. There are several signal formats, including Y/PB/PR and Y/CB/CR.

**CPRM
(Content Protection for Recordable Media)**

This is a format used to record copy-once programs. By recording coded data on the area of DVD discs that ordinary writing software cannot write on, it prevents copy-once programs from being recorded repeatedly on different media.

Digital audio

An indirect representation of sound by numbers. During recording, the sound is measured at discrete intervals (44, 100 times a second for CD audio) by an analog-to-digital converter, generating a stream of numbers. On playback, a digital-to-analog converter generates an analog signal based on these numbers. See also Sampling frequency and Analog audio.

Dolby Digital

The system developed by Dolby Laboratories to compress digital sound. It offers you sound of stereo(2ch) or multi-channel audio (up to 5.1ch).

DTS (Digital Theater System)

DTS is a 5.1 channel surround sound system, but it is different from Dolby Digital. The formats were developed by Digital Theater System, Inc.

Finalize

To make recorded contents on DVD discs possible to be played back on DVD players. With this unit, it is possible to finalize DVD-RW/DVD-R discs.

MP3 (MPEG Audio Layer 3)

MP3 is a method of compressing files. You can copy MP3 files on CD-RW/-R discs from the computer and play back the files on this unit.

**PCM
(Pulse Code Modulation)**

PCM is a format that converts audio into digital data. It is mainly used for Audio CDs and DAT. This unit can play back sounds as realistic as possible by converting even compressed Dolby Digital and MPEG audio to PCM.

Playlist

From this list you can play back contents of a disc in your desired order or sequence. Also it allows to search a specific scene directly.

Progressive scan (480p)

A type of display that does not split each frame into fields, and instead scans directly through all the scanlines of each frame in order. Progressive scan provides less flickering and higher image resolution than traditional (480i) TV signals. Refer to page 14 for instructions on selective progressive scan mode.

Regions code

Regions associate discs and players with particular areas of the world. This unit will only play back discs that have compatible region codes. You can find the region code of your unit by looking at the rear panel. Some discs are compatible with more than one region (or all regions).

Sampling frequency

The rate which sound is measured by a specified interval to turn it into digital audio data. The numbers of sampling in one second defines as sampling frequency. The higher the rate, the better the sound quality is.

**SAP
(Secondary Audio Program)**

Sub-audio channel which is delivered separately from main-audio channel. This audio channel is used as an alternate in bilingual broadcasting.

S-Video output

It delivers independently each signal of color(C) and luminance(Y) to TV as video signals, so that higher-quality picture will be materialized.

Title (DVD only)

A collection of chapters on DVD disc. See also Chapter.

Track

Audio CDs use tracks to divide the content of a disc. The DVD equivalent is called a chapter. See also Chapter.

Others

Specifications

General

System	DVD-Video, DVD-RW/-R, CD-DA, CD-RW/-R, VHS Video Cassette Tape
VCR video heads	Four heads
Power requirements	AC120V, 60 Hz
Power consumption	30W (standby: 3.0W)
Weight	9.48 lbs (4.3 kg)
Dimensions (width x height x depth)	17 3/16" x 2 5/8" x 9 5/8" (435 x 99.5 x 260 mm)
Operating temperature	41F° to 104F° (5°C to 40°C)
Operating humidity	Under 80%
TV format	NTSC

Recording

Recording format	Video Recording format (DVD-RW only), Video format (DVD-RW, DVD-R)
Recordable discs	DVD-ReRecordable, DVD-Recordable

Video recording format

Sampling frequency	13.5MHz
Compression format	MPEG

Audio recording format

Sampling frequency	48kHz
Compression format	Dolby Digital

Tuner

Receivable channels

VHF	2-13ch
UHF	14-69ch
CATV	C1-C125ch

RF Converter

Built-in VHF converter

Converter output

VHF channel 3 or 4

Input/Output

VHF/UHF antenna input/output terminal

VHF/UHF set 75Ω

Video input

Input level
Jacks

Input 1 (rear), 2 (front)
1 Vp-p (75Ω)
RCA jack

Video output

Output level
Jacks

1 Vp-p (75Ω)
RCA jack

S-Video input

Y (luminance) - Input level
C (color) - Input level
Jacks

Input 1 (rear), 2 (front)
1 Vp-p (75Ω)
286 mVp-p (75Ω)
4 pin mini DIN

S-Video output

Y (luminance) - Output level
C (color) - Output level
Jacks

1 Vp-p (75Ω)
286 mVp-p (75Ω)
4 pin mini DIN

Component video output

Output level
Jacks

Y: 1.0 Vp-p (75Ω), Pb/Cb, Pr/Cr: 0.7 Vp-p (75Ω)
RCA jacks

Audio input

During audio input
Jacks

Input 1 (rear), 2 (front) L/R
2V rms (47kΩ)
RCA jacks

Audio output

During audio output
Jacks

Output 1,2 L/R
2V rms (47kΩ)
RCA jacks

Digital audio output

Output level
Jacks

500 mVp-p (75Ω)
RCA jack

Note: The specifications and design of this product are subject to change without notice.

Service Information (For the U.S.)

For the location of the nearest SHARP Authorized Service Center, or to obtain product literature, accessories, supplies or customer assistance, please call **1-800-BE-SHARP** (1-800-237-4277) or visit SHARP's website (<http://www.sharppusa.com>).

Precaciones

Para futura referencia, anote los números de modelo y de serie (indicados en la parte posterior esta unidad) en el espacio provisto.

No. de modelo: DV-RW550U

No. de serie: _____

AVISO: PARA REDUCIR EL RIESGO DE INCENDIO O ELECTROCHOQUE NO EXPONGA ESTE APARATO A LA HUMEDAD.

PRECAUCIÓN: PARA EVITAR DESCARGAS ELÉCTRICAS, HAGA QUE LA PALETA ANCHA DEL ENCHUFE COINCIDA CON LA RANURA ANCHA E INTRODÚZCALA HASTA EL FONDO.



PRECAUCION

PELIGRO DE DESCARGA ELECTRICA NO ABRIR DECLARACIÓN DE CONFORMIDAD



PRECAUCION:

TPARA REDUCIR EL RIESGO DE DESCARGA ELECTRICA, NO quite la cubierta. EL USUARIO NO DEBERA DAR NINGUN TIPO DE SERVICIO A NINGUNA PARTE INTERNA. DEBERA SER REALIZADO SOLO POR PERSONAL DE SERVICIO CALIFICADO.



Este símbolo previene al usuario del voltaje aislado dentro de la unidad que puede provocar descargas eléctricas peligrosas.



Este símbolo advierte al usuario que existen instrucciones de operación y de mantenimiento en la literatura incluida en esta unidad.

ADVERTENCIA—Las reglas de la FCC (Comisión Federal de Comunicaciones) estipulan que cualquier modificación o cambio a este equipo no aprobado expresamente por el fabricante podrá anular la autorización del usuario para operar este equipo.

Este dispositivo cumple con la Parte 15 de las reglas de la FCC (Comisión Federal de Comunicaciones). La operación se encuentra sujeta a las dos condiciones siguientes:

- (1) Este dispositivo no debería producir interferencias perjudiciales, y
- (2) este dispositivo debe aceptar cualquier interferencia recibida, incluyendo las que puedan producir una operación indeseable.

INFORMACION

Este equipo se ha sometido a todo tipo de pruebas y cumple con las normas establecidas para dispositivo digital de Clase B, de conformidad con la Parte 15 de las reglas de la FCC (Comisión Federal de Comunicaciones). Estas reglas están diseñadas para asegurar una protección razonable contra interferencias perjudiciales en las instalaciones residenciales. Este equipo genera, utiliza y puede emitir energía de radiofrecuencia y, si no se instala y utiliza debidamente, es decir, conforme a las instrucciones, podrían producirse interferencias perjudiciales en las radiocomunicaciones. Sin embargo, no se garantiza que estas interferencias no se produzcan en una instalación determinada. Si este equipo ocasiona interferencias en la recepción de radio o televisión, lo cual puede comprobarse con sólo apagar y encender el equipo, intente corregir el problema mediante una o una combinación de las siguientes medidas:

- Reoriente la antena receptora o cámbiela de lugar.
- Aumente la separación entre el equipo y el receptor.
- Enchufe el equipo a una toma de corriente situada en un circuito distinto del receptor.
- Consulte a su distribuidor o a un técnico experto en radio/televisión.

This Class B digital apparatus complies with Canadian ICES-003.

Cet appareil numérique de la classe B est conforme à la norme NMB-003 du Canada.

Este aparato digital de la Clase B cumple con la norma ICES-003 de Canadá.

Aviso al instalador del sistema CATV:

Este aviso tiene la finalidad de llamar la atención del instalador del sistema CATV para que tenga en cuenta el Artículo 820-40 de NEC, que ofrece instrucciones para realizar una conexión a tierra apropiada y, en particular, especifica que el cable de puesta a tierra deberá conectarse al sistema de puesta a tierra del edificio tan cerca del punto de entrada del cable como sea posible.

PRECAUCION:

ESTA UNIDAD HA SIDO CLASIFICADA COMO PRODUCTO CLASS 1 LASER.

EL USO DE MANDOS O AJUSTES O LA REALIZACION DE PROCEDIMIENTOS DISTINTOS DE LOS INDICADOS EN LA PRESENTE IMPLICA EL RIESGO DE EXPOSICION A UNA RADIACION PELIGROSA.

COMO LOS RAYOS LASER UTILIZADOS EN ESTA UNIDAD PUEDEN RESULTAR PERJUDICIALES PARA SUS OJOS, NO INTENTE DESARMAR EL GABINETE. SOLICITE EL SERVICIO UNICAMENTE A PERSONAL CUALIFICADO.

Importantes Medidas de Seguridad y Precauciones

- 1) Lea las instrucciones - Lea detenidamente todas las instrucciones de seguridad y operación antes de usar el producto.
- 2) Conserve las instrucciones - Conserve las instrucciones de seguridad y operación para consultas futuras.
- 3) Respete las advertencias - Observe estrictamente todas las advertencias impresas en el producto y las incluidas en el manual de instrucciones.
- 4) Siga las instrucciones - Siga todas las instrucciones de operación.
- 5) Limpieza - Desconecte el producto del tomacorriente mural antes de limpiarlo. No use limpiadores líquidos ni aerosol. Use un paño húmedo para la limpieza del producto.
- 6) Enchufes - No use enchufes no recomendados por el fabricante del producto, ya que podría ser peligroso.
- 7) Agua y humedad - No use este producto cerca del agua, por ejemplo, cerca de una bañera o lavamanos, cerca del fregadero de la cocina o lavandería, en un piso mojado, cerca de una piscina, etc.
- 8) Accesorios - No instale este producto en un carro, soporte, trípode o mesa inestables. El grabador de videocassettes podría caerse, causando serias lesiones a un niño o adulto, resultando también severamente dañado. Úselo sólo en un carro, soporte, trípode o mesa recomendados por el fabricante, o vendidos con el producto. Toda instalación del producto deberán hacerse de acuerdo a las instrucciones del fabricante, empleando los accesorios de instalación recomendados por el mismo.

- 9) La combinación de producto y carro debe ser movida con cuidado. Las detenciones bruscas, la fuerza excesiva y las superficies dispares harán que el producto y el carro se vuelquen.
- 10) Ventilación - El gabinete del producto tiene renuras y aberturas de ventilación que garantizan el funcionamiento confiable del producto, evitando que se recaliente. Estas aberturas no deberán ser bloquear las aberturas, nunca setúe el grabador de videocassettes encima de una cama, sofá, alfombra u otra superficie similar. El grabador de videocassettes no debe ser instalado en un mueble empujado, como una repisa para libros o bastidor, a menos que se pueda garantizar una ventilación adecuada, o cuando las instrucciones del fabricante así lo especifiquen.
- 11) Alimentación - Este grabador de videocassettes sólo debe ser operado mediante el tipo de fuente de alimentación especificado en la etiqueta indicadora. Si no seta seturo del tipo de fuente de alimentación que tiene en su casa, consulte a su distribuidor o a la compañía de electricidad local. En el caso de grabador de diseñados para funcionar a pilas o con otras fuentes de alimentación, consulte el manual de instrucciones respectivo.
- 12) Conexión a tierra o polarización - Este producto está equipado con una clavija polarizada de corriente alterna (una clavija que tiene una espiga más ancha que la otra). Esta clavija solamente podrá ser insertada en el tomacorriente en una sola dirección. Esta es una medida de seguridad. Si no pudiera insertar completamente la clavija en el tomacorriente, vuelva a intentarlo invirtiendo la clavija. Si aún no fuera posible insertar la clavija, tome contacto con un electricista para que repare su tomacorriente obsoleto. No modifique las características de seguridad de la clavija polarizada.
- 13) Protección del cable de alimentación - Los cables de alimentación deberán ser tendidos de manera tal que la probabilidad de que sean pisados o aplastados por otros objetos sea mínima. Preste especial atención a las clavijas de los cables, a los receptáculos, y al punto por donde salen del producto.
- 14) Conexión Tierra de una Antena Exterior: Si una antena exterior o sistema de cable es conectado al aparato de vídeo, asegúrese de que la antena o el cableado tenga conexión tierra para conseguir de esta manera una protección contra voltajes no deseados y cargas estáticas. El artículo 810 del Código de Electricidad Nacional ANSI/NFPA número 70, proporciona información acerca de la manera adecuada de conexiones a tierra de la estructura del mástil y la estructura soporte, sobre la unidad del cable del interior de cobre de antena, tamaño de los conductores tierra, ubi-

cación de la unidad de descarga de la antena, conexión a los electrodos tierra, y requerimientos de los electrodos tierra (Fig. A).

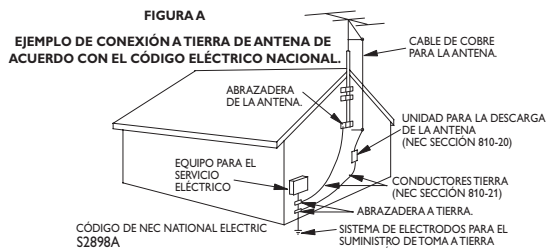

ADVERTENCIA SOBRE EL USO DE CARROS PORTÁTILES



- 15) Tormentas eléctricas - Como medida adicional de protección durante tormentas eléctricas, o cuando el producto permanezca sin uso durante períodos prolongados de tiempo, desconéctelo del tomoacorriente mural y desconecte la antena o sistema de cable. Esto evitará que el grabador de videocassettes resulte dañado por tormentas eléctricas o sobretensiones en la línea de alimentación.
- 16) Líneas de alimentación - Un antena exterior no debe ser instalada en la cercanía de líneas de alimentación aéreas ni de otros circuitos de potencial para iluminación eléctrica, o donde pueda caerse y hacer contacto con tales líneas o circuitos. Al instalar un sistema de antena exterior, enta mucho cuidado de no tocar tales líneas o circuitos de alimentación, ya que el contacto con ellos podría ser fatal.
- 17) Sobrecarga - No sobrecargue los tomacorrientes murales ni los cables de extensión, ya que esto podría causar incendios o descargas eléctricas.
- 18) Entrada de objetos y líquidos - Nunca introduzca objetos de ningún tipo por las aberturas de sete producto, ya que podría tocar peligrosos puntos de alta tensión o cortocircuitar partes, provocando incendios o descargas eléctricas. Nunca derrame ningún tipo de líquido sobre el producto.
- 19) Servicio - No intente reparar el producto usted mismo; al abrir o desmontar las cobiertas usted se expondrá a alta tensión y a otros peligros. Solicite todo servicio a personal calificado.
- 20) Daños que requieran reparación - En los siguientes casos, desconecte el producto del tomacorriente mural y llame a un técnico de servicio calificado:
 - a) Cuando el cable de alimentación o la clavija estén dañados,
 - b) Si se ha derramado líquido sobre la unidad, o si algún objeto ha caído dentro del producto,
 - c) Si el producto ha sido expuesto a la lluvia o al agua,
 - d) Cuando a pesar de haber sebuído las instrucciones de operación, el producto no funcione normalmente. Ajuste solamente los controles mencionados en el manual de instrucciones; el ajuste incorrecto de otros controles podrá causar daños a la unidad, la que por lo general requerirá de un prolongado trabajo de reparación (por un técnico calificado) para que sus condiciones normales de operación puedan ser restablecidas,
 - e) Si el producto se ha caído o si el gabinete se ha dañado.
 - f) Cuando el producto muestre un cambio notorio en su rendimiento.
- 21) Piezas de requesto - Cuando sea necesario reemplazar piezas, asegúrese de que el técnico de servicio emplee las piezas de requesto especificadas por el fabricante, o piezas que tengan las mismas características que las piezas originales. Las sustituciones no autorizadas podrán causar incendios, descargas eléctricas y otros problemas.
- 22) Revisión de seguridad - Al finalizar cualquier servicio de mantenimiento o reparación de este producto, solicítele al técnico que efectúe comprobaciones de seguridad para determinar si el producto se encuentra o no en condiciones óptimas de operación.
- 23) Calor - Este producto debe colocarse fuera del alcance de fuentes de calor tales como radiadores, rejillas de calefacción, estufas o cualquier otro producto destinado a producir calor, incluyendo los amplificadores.

Fácil grabación de DVD

Estas instrucciones le ayudarán a entender fácilmente cómo grabar discos DVD. Asegúrese que las pilas están en el mando a distancia y que ha conectado correctamente esta unidad y el TV.

Paso 1: Elija un tipo de disco

Puede elegir entre distintos tipos de discos DVD grabables. Elija un tipo de disco DVD grabable de acuerdo con sus necesidades de reproducción/grabación. Vea los "Tipos de disco DVD" en la parte inferior de esta página para más detalles sobre las diferencias entre los distintos medios compatibles.

Este grabador de DVD puede grabar los siguientes tipos de discos.



Por ejemplo, cuando desea grabar repetidamente en el mismo disco o cuando desea editar el disco después de grabar, seleccione el disco de tipo regrabable DVD-RW.

Cuando desea guardar grabaciones sin alterarlos, un DVD no regrabable DVD-R puede ser más conveniente.

Paso 2: Coloque un disco en blanco

Mando a distancia

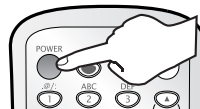

1 Para encender.



2 Seleccione el modo DVD.



3 Para abrir.

4

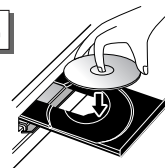

5 Para cerrar.

Cargando

Esta operación puede demorar en reconocerse.

Tipos de disco DVD

☆☆☆ : Más adecuado ☆☆☆ : Puede utilizar ☆ : Algunas funciones son limitadas — : No puede utilizar

Desea	DVD-RW VR	DVD-RW Video	DVD-R Video
Grabar programas de TV	☆☆☆	☆☆☆	☆☆
Volver a utilizar borrando partes no deseadas	☆☆☆	☆☆	—
Editar las grabaciones	☆☆☆	☆	☆
Editar/grabar de equipos conectados	☆☆☆	☆☆☆	☆☆☆
Copiar discos para distribución	☆☆ ^{*1}	☆☆☆	☆☆☆
Reproducir en otro equipo de DVD	☆☆ ^{*1}	☆☆☆	☆☆☆

Detalles	DVD-RW VR	DVD-RW Video	DVD-R Video
Grabación			
¿Regrabable?	Sí	Si	No
Puede crear capítulos a intervalos fijos (auto.)	Sí	Si	Si
Puede crear capítulos donde desee (manual)	Sí	No	No
Puede grabar imágenes de tamaño 16:9	Sí	Si	Si
Puede grabar un programa de Copia-una-vez	Sí	No	No
Edición			
Puede hacer funciones de edición básica	Sí	Si	Si
Puede hacer funciones de edición avanzadas (edición de lista a reproducir)	Sí	No	No

^{*1} El DVD-RW (modo VR) sólo puede reproducirse en equipos de DV compatibles con VR.

Nota

Para más detalles sobre las funciones anteriores y las limitaciones implícitas, lea las explicaciones en este manual.

Formato del disco

Coloque el disco en el grabador. Haga el formato del disco del menú Setting, existen los formatos de video (modo de Video) o de grabación de video (modo VR) según el tipo de disco colocado.

Esto es necesario para preparar el disco para grabación. Vea los detalles en las páginas 28-29.

Al formatear, todo el contenido de ese disco se borrarán.

- La unidad empieza a formatear automáticamente cuando se inserta un disco no usado.

Paso 3: Seleccione la velocidad de grabación

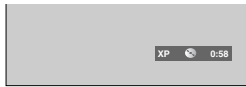
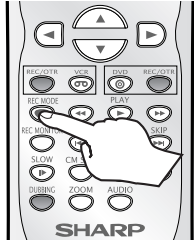

Paso 4: Seleccione el canal deseado

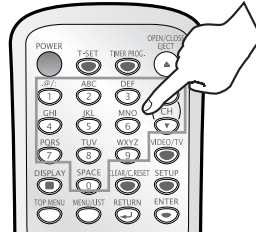

Paso 5: Grabe en discos DVD

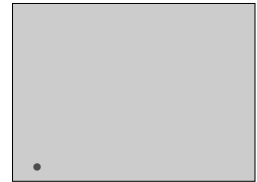
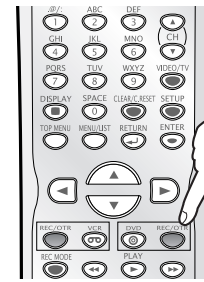

Sugerencia 1: Reproduzca el contenido grabado

Puede seleccionar el título que desea reproducir de un menú indicado y empiece a reproducir inmediatamente. El contenido grabado se puede acceder fácilmente con un simple procedimiento de elegir un título en un capítulo en la pantalla del menú.

¿Qué son títulos y capítulos?

El contenido de un disco DVD se divide generalmente en títulos. Los títulos pueden dividirse a su vez en capítulos.

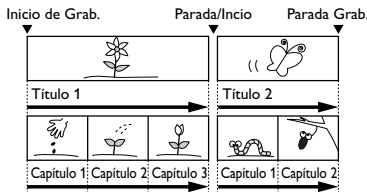

Sugerencia 2: Edite el disco grabado

La edición de discos es fácil. Esta unidad ofrece convenientes funciones de edición que sólo son posibles con discos DVD-RW/-R.

Puede editar lo siguiente de la lista de títulos.

- Poniendo nombres en títulos
- Seleccionando imágenes para índices
- Seleccionando/borrando marcadores de capítulos
- Borrado de partes de títulos o escenas

(Las funciones editables dependen del modo de grabación y forma de edición.)

Original y Playlist (modo VR)

Puede editar las grabaciones en la lista a reproducir sin cambiar las grabaciones originales. Cualquier lista a reproducir no ocupa mucho espacio en el disco.

¿Qué significa "Original" o "Playlist" ?

A lo largo de este manual encontrará *Original* y *Playlist* que se refieren a las grabaciones reales y la versión editada.

- La grabación **Original** se refiere a la grabación real en el disco.
- El **Playlist** se refiere a la versión editada del disco; cómo se va a reproducir la versión Original.

Finalización de un disco

- Para reproducir el disco en un reproductor DVD diferente, grade el disco en el modo de video y finalícelo.
- Después de finalizar un disco grabado en el modo de video, usted no podrá editar ninguna Información que se encuentre on este disco.
- Para un disco grabado en el modo VR, la edición podrá realizarse incluso después de la finalización.

Paso 6: Pare la grabación

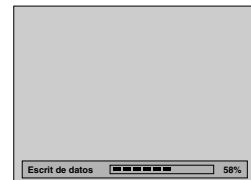
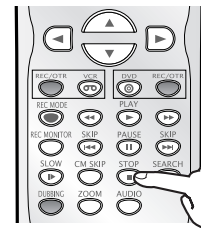

Aparece sólo en el modo DVD-RW VR



Esta operación puede demorar en completarse.

Reproducción con videgrabadora



1

Presione **POWER** en el mando a distancia o el panel frontal de la unidad.

Cuando reproduzca una cinta, conecte el TV y asegúrese de seleccionar la entrada donde se conecta la unidad.



2

Coloque una cinta pregrabada y presione **PLAY** ► para empezar la reproducción.

3

Durante la reproducción, presione **PAUSE** II.

Se hará una pausa de reproducción y se silenciará el sonido.

4

Presione **PLAY** ► para continuar la reproducción.

5

Presione **STOP** ■ para detener la reproducción.

6

Presione **STOP/EJECT** ■ / ▲ en el panel frontal de la unidad para expulsar la cinta.

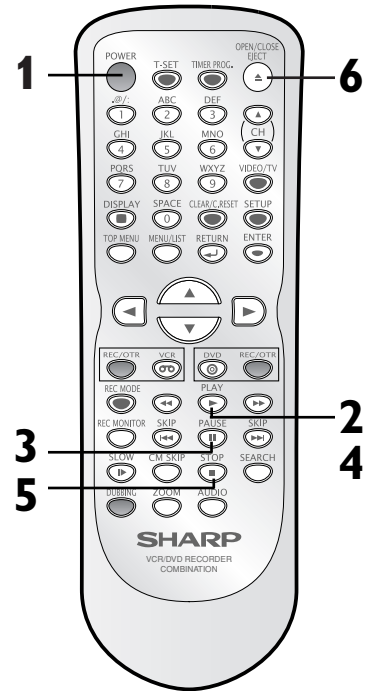

Nota

- Cuando se coloca una cinta sin la lengüeta de grabación, la unidad empezará a reproducir automáticamente.
- El seguimiento se ajustará automáticamente para la reproducción. Para ajustar manualmente el seguimiento, presione **CHANNEL** ▲ / ▼ en el panel frontal de la unidad o **CH** ▲ / ▼ en el mando a distancia.

Grabación y grabación con temporizador de un toque (VCR)

Grabación



Antes de grabar, asegúrese de que:

- Se seleccionó el canal deseado presionando **los botones numéricos** en el mando a distancia o **CHANNEL ▲ / ▼** en el panel frontal de la unidad.
- Hay una cinta con la lengüeta para grabación intacta en la unidad.
- Se seleccionó la velocidad de grabación deseada en SP (reproducción estándar) o SLP (reproducción de super larga duración) presionando **REC MODE** en el mando a distancia.

Velocidad de grabación:

Velocidad de la cinta	Tiempo de grabación/reproducción		
	T60	T120	T160
Modo SP	1 hora	2 horas	2-2/3 horas
Modo SLP	3 horas	6 horas	8 horas

- Se selecciona Estéreo o SAP.



1

Presione REC/OTR para empezar la grabación.

Para detener temporalmente la grabación o continuarla, presione **PAUSE II**. Después de que la unidad haya estado en el modo de pausa durante 5 minutos, se detendrá automáticamente para proteger al cinta y el cabezal de video contra cambios.

2

Presione STOP ■ cuando se complete la grabación.

Prevenición contra borrado accidental

Para evitar una grabación por accidente en un casete grabado, rompa la lengüeta de grabación. Para volver a grabar posteriormente, cubra el orificio con cinta adhesiva.

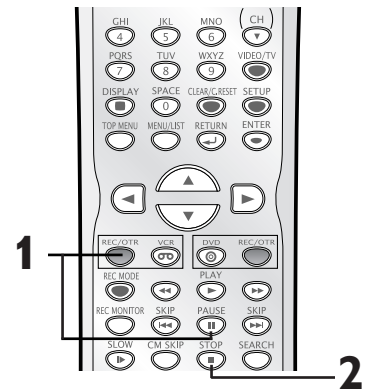

Nota

- Para ver un canal mientras graba en otro
 - 1) Mientras está grabando en la unidad, presione **VIDEO/TV**.
 - 2) En la caja de cable o caja de satélite, seleccione el canal que desea ver.
- Si se conectó la unidad a una caja de cable o caja de satélite, consulte la sección de "Connection to a cable box or satellite box" en la página 15.

Grabación con temporizador de un toque (OTR)



Esta función permite seleccionar la longitud de la grabación simplemente presionando **REC/OTR** en el mando a distancia o en el panel frontal de la unidad.



1

Durante la grabación normal, presione REC/OTR para empezar la grabación con temporizador de un toque. Puede seleccionar un tiempo de grabación determinado presionando repetidamente **REC/OTR**.

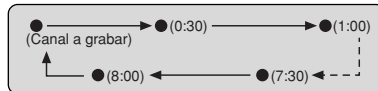

Cuando termina la grabación con temporizador de un toque, la unidad se desconectará automáticamente.

Para cambiar la longitud de tiempo durante la grabación con temporizador de un toque, presione repetidamente **[REC/OTR]** hasta que aparezca la longitud deseada.

Para cancelar la grabación con temporizador de un toque dentro del tiempo especificado, presione **STOP ■**.

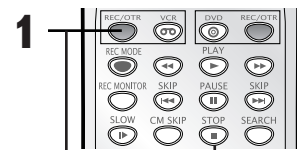

Nota

- El tiempo de grabación remanente aparecerá en la pantalla durante una grabación con temporizador de un toque. Presione **DISPLAY** para que aparezca en la pantalla de TV.
- No puede hacer una pausa en una grabación con temporizador de un toque.
- Si se termina el OTR en la videograbadora durante el modo de reproducción o REC en DVD, la videograbadora estará en el modo STOP y la DVD se mantiene en el modo actual.
- A diferencia de una grabación con temporizador, durante una grabación con temporizador de un toque usted puede realizar las operaciones siguientes.
 - Desconectar la alimentación.
 - Utilizar **REC/OTR** o **STOP ■**.

Note

CONSUMER LIMITED WARRANTY

(Valid for warranty service in the U.S. only)

SHARP ELECTRONICS CORPORATION warrants to the first consumer purchaser that this Sharp brand product (the "Product"), when shipped in its original container, will be free from defective workmanship and materials, and agrees that it will, at its option, either repair the defect or replace the defective Product or part thereof with a new or remanufactured equivalent at no charge to the purchaser for parts or labor for the period(s) set forth below.

This warranty does not apply to any appearance items of the Product nor to the additional excluded item(s) set forth below nor to any Product the exterior of which has been damaged or defaced, which has been subjected to improper voltage or other misuse, abnormal service or handling, or which has been altered or modified in design or construction.

In order to enforce the rights under this limited warranty, the purchaser should follow the steps set forth below and provide proof of purchase to the servicer.

The limited warranty described herein is in addition to whatever implied warranties may be granted to purchasers by law. ALL IMPLIED WARRANTIES INCLUDING THE WARRANTIES OF MERCHANTABILITY AND FITNESS FOR USE ARE LIMITED TO THE PERIOD(S) FROM THE DATE OF PURCHASE SET FORTH BELOW. Some states do not allow limitations on how long an implied warranty lasts, so the above limitation may not apply to you.

Neither the sales personnel of the seller nor any other person is authorized to make any warranties other than those described herein, or to extend the duration of any warranties beyond the time period described herein on behalf of Sharp.

The warranties described herein shall be the sole and exclusive warranties granted by Sharp and shall be the sole and exclusive remedy available to the purchaser. Correction of defects, in the manner and for the period of time described herein, shall constitute complete fulfillment of all liabilities and responsibilities of Sharp to the purchaser with respect to the Product, and shall constitute full satisfaction of all claims, whether based on contract, negligence, strict liability or otherwise. In no event shall Sharp be liable, or in any way responsible, for any damages or defects in the Product which were caused by repairs or attempted repairs performed by anyone other than an authorized servicer. Nor shall Sharp be liable or in any way responsible for any incidental or consequential economic or property damage. Some states do not allow the exclusion of incidental or consequential damages, so the above exclusion may not apply to you.

THIS WARRANTY GIVES YOU SPECIFIC LEGAL RIGHTS. YOU MAY ALSO HAVE OTHER RIGHTS WHICH VARY FROM STATE TO STATE.

Model Specific Section

Your Product Model Number & Description: DV-RW550U VCR/DVD Recorder Combination

(Be sure to have this information available when you need service for your Product.)

Warranty Period for this Product: One (1) year parts and ninety (90) days labor from date of purchase.

Additional Item(s) Excluded from warranty Coverage (if any): Non-rechargeable batteries.

Where to Obtain Service: Call Sharp Electronics corporation toll free at 1-800-BE-SHARP for instructions on how to obtain service on your VCR/DVD Recorder combination.

What to do to Obtain Service: Ship your product, prepaid, as per the instruction given by the Sharp representative at the toll free number (1-800-BE-SHARP). BE sure to have your proof of purchase available. Be sure to ship the product securely packaged and insured against shipping damage.

TO OBTAIN SUPPLY, ACCESSORY OR PRODUCT INFORMATION, GO TO OUR WEBSITE AT www.sharppusa.com OR CALL 1-800-BE-SHARP.

SHARP®

SHARP ELECTRONICS CORPORATION

Sharp Plaza, Mahwah, New Jersey 07430-2135

SHARP CORPORATION

Osaka, Japan

9HS1VMN20561
E9656UD★★★★★
1VMN20561

Printed in China