

SHARP®

LIQUID CRYSTAL DISPLAY CAMCORDER

MODEL
VL-NZ50U

■ OPERATION MANUAL ■

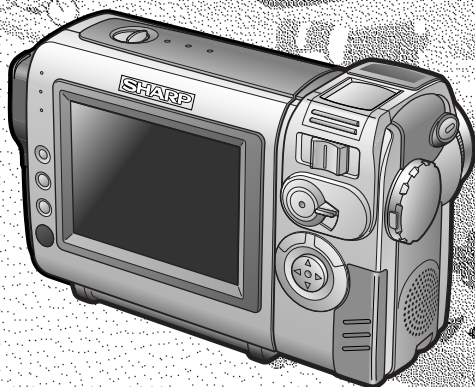

SHARP VIEWCAM

Mini **DV**

• The ^{Mini} DV logo is a trademark.

Please read this operation manual carefully before using the camcorder.

Important

For assistance in reporting the theft or loss of this product, record on the line below the model number and serial number which are located on the bottom of the unit. Please retain this information.

Model No.:

Serial No.:

• See page 57 for use of Demo mode.

Operation References

Preparation

Basic Operations

Useful Features

Advanced Features

Appendix

Thank you for purchasing this camcorder from SHARP.

The camcorder will enhance your home video enjoyment and allow you to capture those special moments. Please read this operation manual to familiarize yourself with the camcorder's features, so that you will get the most out of it. The video techniques section will help you fully enjoy the many features this camcorder offers, and expand your video world.

Important Information for Consumers in the U.S.

WARNING: TO REDUCE THE RISK OF FIRE OR ELECTRIC SHOCK, DO NOT EXPOSE THIS APPLIANCE TO RAIN OR MOISTURE.



CAUTION:
TO REDUCE THE RISK OF ELECTRIC SHOCK, DO NOT REMOVE COVER. NO USER-SERVICEABLE PARTS INSIDE. REFER SERVICING TO QUALIFIED SERVICE PERSONNEL.



This symbol warns the user of uninsulated voltage within the unit that can cause dangerous electric shocks.



This symbol alerts the user that there are important operating and maintenance instructions in the literature accompanying this unit.

CAUTION

(applies to the supplied AC adapter)

TO PREVENT ELECTRIC SHOCK, MATCH WIDE BLADE OF PLUG TO WIDE SLOT, FULLY INSERT.

CAUTION

If the AC adapter is misplaced or needs to be replaced, obtain the same type of adapter from a SHARP service center of your dealer.

PRODUCT DISPOSAL

This Product utilizes tin-lead solder, and a fluorescent lamp containing a small amount of mercury. Disposal of these materials may be regulated due to environmental considerations. For disposal or recycling information, please contact your local authorities or the Electronics Industries Alliance: www.eiae.org.

BATTERY DISPOSAL

CONTAINS LITHIUM-ION RECHARGEABLE BATTERY. MUST BE RECYCLED OR DISPOSED OF PROPERLY. CONTACT LOCAL AGENCIES FOR INFORMATION ON RECYCLING AND DISPOSAL PLANS IN YOUR AREA.

WARNING—FCC Regulations state that any unauthorized changes or modifications to this equipment not expressly approved by the manufacturer could void the user's authority to operate this equipment.

INFORMATION

This equipment has been tested and found to comply with the limits for a Class B digital device, pursuant to Part 15 of the FCC Rules. These limits are designed to provide reasonable protection against harmful interference in a residential installation. This equipment generates, uses, and can radiate radio frequency energy and, if not installed and used in accordance with the instructions, may cause harmful interference to radio communications. However, there is no guarantee that interference will not occur in a particular installation. If this equipment does cause harmful interference to radio or television reception, which can be determined by turning the equipment off and on, the user is encouraged to try to correct the interference by one or more of the following measures:

- Reorient or relocate the receiving antenna.
- Increase the separation between the equipment and receiver.
- Connect the equipment into an outlet on a circuit different from that to which the receiver is connected.
- Consult the dealer or an experienced radio/TV technician for help.

DECLARATION OF CONFORMITY

Sharp Camcorder

This device complies with Part 15 of the FCC Rules. Operation is subject to the following two conditions: (1) This device may not cause harmful interference, and (2) this device must accept any interference received, including interference that may cause undesired operation.

RESPONSIBLE PARTY:

SHARP ELECTRONICS CORPORATION
Sharp Plaza, Mahwah, New Jersey 07430
Phone: 1-800-BE-SHARP

CAUTION ON LITHIUM BATTERY (MEMORY BACKUP BATTERY)

If a battery is reversed (positive end where the negative end belongs and vice versa), it can overheat and rupture. This has happened when young children install batteries backwards. Warn children *not* to take out batteries or install them. *Parents should install the lithium battery in the camcorder.*

COPYRIGHT WARNING: It is the intent of SHARP that this unit be used in full compliance with the copyright laws of the United States and that prior permission be obtained from copyright owners whenever necessary.

NOTE

The camcorder's LCD panel is a very high technology product with more than 120,000 thin-film transistors*, giving you fine picture detail. Occasionally, a pixel may appear on the screen as a fixed point of blue, green, red, or black. Please note that this does not affect your camcorder's performance.

*Specifications are subject to change without notice.

IMPORTANT SAFEGUARDS

1. **Read Instructions**—All the safety and operating instructions should be read before the product is operated.
2. **Retain Instructions**—The safety and operating instructions should be retained for future reference.
3. **Heed Warnings**—All warnings on the product and in the operating instructions should be adhered to.
4. **Follow Instructions**—All operating and use instructions should be followed.
5. **Cleaning**—Unplug this product from the wall outlet before cleaning. Do not use liquid cleaners or aerosol cleaners. Use a damp cloth for cleaning.
6. **Attachments**—Do not use attachments not recommended by the product manufacturer as they may cause hazards.
7. **Water and Moisture**—Do not use this product near water—for example, near a bath tub, wash bowl, kitchen sink, or laundry tub; in a wet basement; or near a swimming pool; and the like.
8. **Accessories**—Do not place this product on an unstable cart, stand, tripod, bracket, or table. The product may fall, causing serious injury to a child or

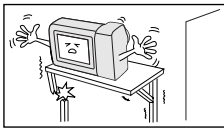

adult, and serious damage to the product. Use only with a cart, stand, tripod, bracket,

or table recommended by the manufacturer, or sold with the product. Any mounting of the product should follow the manufacturer's instructions, and should use a mounting accessory recommended by the manufacturer.

9. A product and cart combination should be moved with care. Quick stops, excessive force, and uneven surfaces may cause the product and cart combination to overturn.
10. **Ventilation**—Slots and openings in the cabinet are provided for ventilation and to ensure reliable operation of the product and to protect it from overheating, and these openings must not be blocked or covered. The openings



should never be blocked by placing the product on a bed, sofa, rug, or other similar surface. This product should not

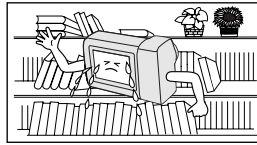

be placed in a built-in installation such as a bookcase or rack unless

proper ventilation is provided or the manufacturer's instructions have been adhered to.

11. **Power Sources**—This product should be operated only from the type of power source indicated on the marking label. If you are not sure of the type of power supply to your home, consult your product dealer or local power company. For products intended to operate from battery power, or other sources, refer to the operating instructions.
12. **Grounding or Polarization**—This product may be equipped with a polarized alternating-current line plug (a plug having one blade wider than the other). This plug will fit into the power outlet only one way. This is a safety feature. If you are unable to insert the plug fully into the outlet, try reversing the plug. If the plug should still fail to fit, contact your electrician to replace your obsolete outlet. Do not defeat the safety purpose of the polarized plug.
13. **Power-Cord Protection**—Power-supply cords should be routed so that they are not likely to be walked on or pinched by items placed upon or against them, paying particular attention to cords at plugs, convenience receptacles, and the point where they exit from the product.
14. **Lightning**—For added protection for this product during a lightning storm, or when it is left unattended and unused for long periods of time, unplug it from the wall outlet and disconnect the antenna or cable system. This will prevent damage to the product due to lightning and power-line surges.

-
15. Power Lines—An outside antenna system should not be located in the vicinity of overhead power lines or other electric light or power circuits, or where it can fall into such power lines or circuits. When installing an outside antenna system, extreme care should be taken to keep from touching such power lines or circuits as contact with them might be fatal.
 16. Overloading—Do not overload wall outlets, extension cords, or integral convenience receptacles as this can result in a risk of fire or electric shock.
 17. Object and Liquid Entry—Never push objects of any kind into this product

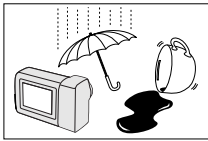

through openings as they may touch dangerous voltage points or short-out parts that could result in a fire or electric shock. Never spill liquid of any kind on the product.

18. Servicing—Do not attempt to service this product yourself as opening or removing covers may expose you to dangerous voltage or other hazards. Refer all servicing to qualified service personnel.
19. Damage Requiring Service—Unplug this product from the wall outlet and refer servicing to qualified service personnel under the following conditions:
 - a. When the power-supply cord or plug is damaged,
 - b. If liquid has been spilled, or objects have fallen into the product,
 - c. If the product has been exposed to rain or water,
 - d. If the product does not operate normally by following the operating instructions. Adjust only those controls that are covered by the operating instructions as an improper adjustment of other controls may result in damage and will often require extensive work by a qualified technician to restore the product to its normal operation,
 - e. If the product has been dropped or damaged in any way, and
 - f. When the product exhibits a distinct change in performance—this indicates a need for service.
20. Replacement Parts—When replacement parts are required, be sure the service technician has used replacement parts specified by the manufacturer or have the same characteristics as the original part. Unauthorized substitutions may result in fire, electric shock, or other hazards.
21. Safety Check—Upon completion of any service or repairs to this product, ask the service technician to perform safety checks to determine that the product is in proper operating condition.
22. Wall or Ceiling Mounting—The product should be mounted to a wall or ceiling only as recommended by the manufacturer.
23. Heat—The product should be situated away from heat sources such as radiators, heat registers, stoves, or other products (including amplifiers) that produce heat.

Quick Operation Guide

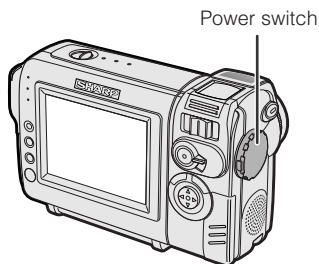

Please consult this operation manual further for details on these and other functions of your camcorder.

Attaching the Battery Pack



- 1 Make sure that the Power switch is set to OFF.



- 2 Align the  mark on the side of the battery pack with the  mark on the camcorder (1), and slide the battery pack in the direction of the arrow completely until it locks into place (2).

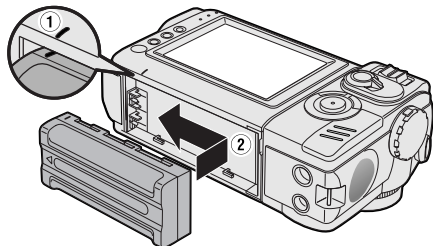

Charging the Battery Pack

- 1 Attach the battery pack on the camcorder, and make sure that the Power switch is set to OFF.
- 2 Plug the AC adapter into a power outlet (1), then insert the DC plug into the DC input jack (2).

- The charge indicator lights up.

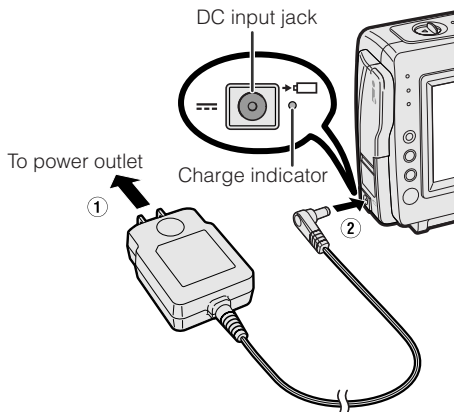

- The charge indicator turns off when the battery is charged.

- 3 Remove the DC plug from the DC input jack, then remove the AC adapter from the power outlet.

Inserting a Cassette

- 1 Attach the power source to the camcorder, then slide the cassette compartment door release and open the cassette compartment door.
 - After confirmation sound, the cassette holder extends and opens automatically.

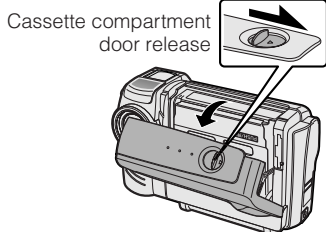

- 2 Insert a commercially available cassette fully with the window facing outwards, and with the erasure protect tab facing upwards.

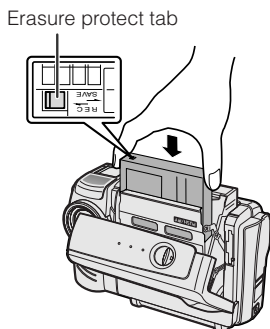

- 3 Press the **PUSH/押す** mark gently until the cassette holder clicks into place.
 - After confirmation sound, the cassette holder retracts automatically.

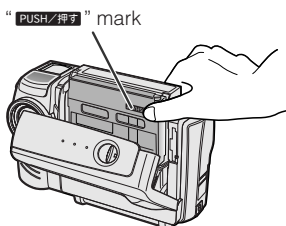

- 4 Wait for the cassette holder to fully retract. Close the compartment door by pressing the center until it clicks into place.

Tips on Recording Positions

To create images that are easy to watch during playback, try to record with an upright posture and steady hand to prevent a shaky image.

Holding the camcorder

Place your right thumb close to the REC START/STOP button and Power Zoom control. Place your left thumb on the thumb rest on the left side of the screen.

Basic posture

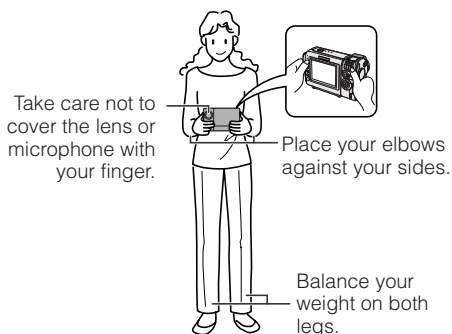

Shooting from a high angle

Turn the LCD monitor so that the screen faces downward.



Shooting from a low angle

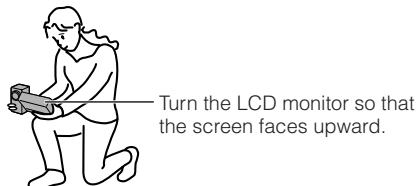

Quick Operation Guide

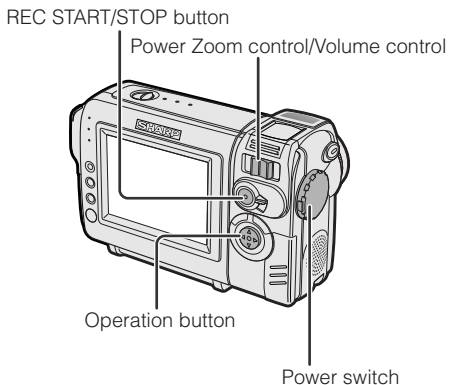

Easy Camera Recording

- 1 Insert a cassette into the camcorder.
- 2 Hold down the Lock button and set the Power switch to CAMERA.
 - The picture from the lens now displays.

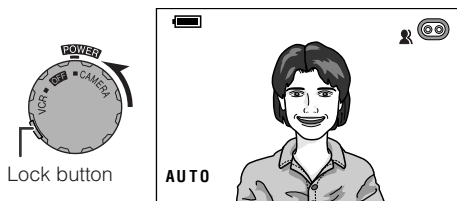

- 3 Press the REC START/STOP button to begin recording.

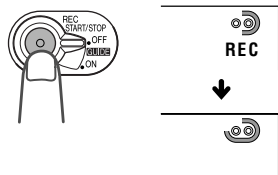

To pause recording

Press the REC START/STOP button again.

Zooming

Push the Power Zoom control to T (①) (telephoto) or W (②) (wide angle) side.

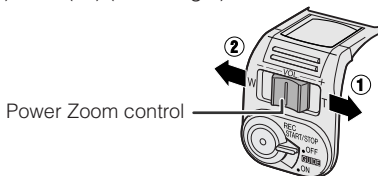

Playback

- 1 Hold down the Lock button and set the Power switch to VCR.
 - The picture from the lens now displays.
- 2 Press < (or >) on the Operation button to rewind (or fast forward) the tape to the desired point.

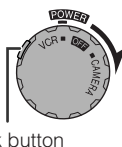

- 3 Press \blacktriangle to begin playback.



To stop playback

Press \blacktriangledown .

Volume Control

Push the Volume control to the + or - side to increase (①) or decrease (②) the volume.

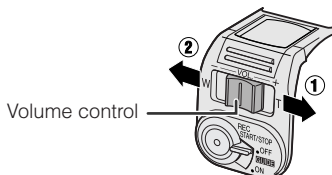

Precautions

- **When the camcorder is not in use, remember to remove the cassette tape, turn off the power, and disconnect the camcorder from the power source.**

- **Do not aim the lens at the sun.**

Do not allow direct sunlight to strike the camcorder lens or LCD monitor screen, whether or not recording is in progress, as it may damage the CCD sensor or LCD screen surface. Be particularly careful when recording outside.

- When shooting in dark places, avoid sudden brightly lit objects or light sources, such as the sun. Otherwise, the image may white out. Should this happen, point the lens in a different direction until the picture returns to normal.

- **Avoid magnetic sources.**

Using the camcorder near strong fluorescent lights, motors, televisions, or other magnetic sources may adversely affect recorded images.

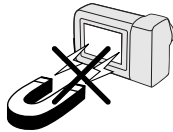

- **Using the camcorder near a broadcasting station or other powerful transmission source may cause buzzing or picture deterioration.**

- **Avoid shocks and dropping.**

Do not drop or otherwise subject the camcorder to hard shocks or strong vibrations. Bumping or striking the unit during recording will generate noise in the recorded image.

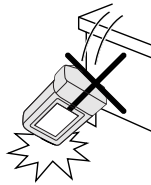

- **Avoid placing the camcorder in close proximity to lighting equipment.**

The heat from incandescent lights may deform the camcorder, or cause it to malfunction.

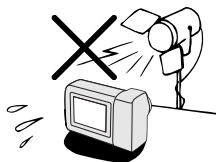

- **Always respect prohibitions or restrictions on the use of electronic equipment on commercial flights or in other sensitive areas.**

- **Be aware of the temperature and humidity.**

You can use your camcorder at 32°F to 104°F (0°C to +40°C), and at 30% to 80% relative humidity. Do not store the unit in an unventilated car in the summer, in direct sunlight, or near strong heat sources; this can result in severe damage to the unit casing and circuitry.



- **Avoid situations where water, sand, dust or other foreign matter could get on or inside the camcorder, and do not use or leave your camcorder in areas with excessive smoke, steam or moisture.**

Such environments can cause malfunctions or cause mildew to form on the lenses. Be sure to keep the unit in a well-ventilated location.

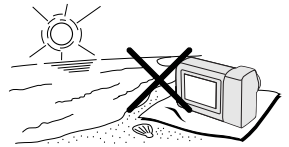



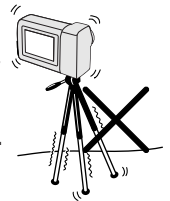



- **Some small, portable tripods may be difficult to attach and may not be sturdy enough to support your camcorder. Be sure to use only a strong, stable tripod.**

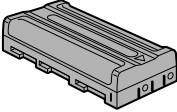
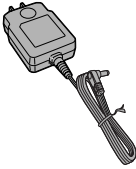

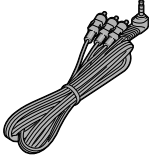
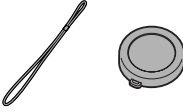
- **When using your camcorder in a cold environment, the LCD monitor screen often appears less bright immediately after the power is turned on. This is not a malfunction. To prevent the camcorder from becoming too cold, wrap it in a thick cloth (a blanket, etc.).**

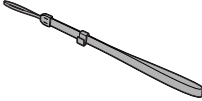
Supplied Accessories

 <p>Battery pack BT-L225□*</p>	 <p>AC adapter UADP-0339TAZZ*</p>	 <p>CR2025 type lithium battery</p>	 <p>Audio/video cable QCNW-1979TAZZ</p>
 <p>Lens cap GCOVH1296TASA</p>	 <p>Lens hood GCOVA1870TASA</p>	 <p>Wrist strap UBNDT0145TASA</p>	 <p>Tripod adapter GDAI-A001WJZZ</p>

* The part numbers for the AC adapter and battery pack supplied with this camcorder are valid only in the U.S. and Latin America. If this camcorder was purchased outside of these areas, the part numbers may be different. Please refer to the part numbers printed on the labels of the supplied AC adapter and battery pack.

Optional Accessories

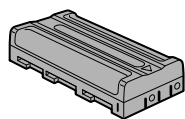

Standard-life
battery pack
BT-L225

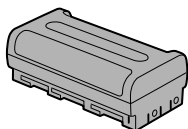

Extended-life
battery pack
BT-L445

Note:

- The listed model names are for U.S. accessories.

For optional and additional accessories, contact your local dealer, call the Sharp Accessories and Supply Center at 1-800-642-2122, or visit SHARP's website (<http://www.sharp-usa.com>).

Contents

<u>Operation References</u>	Part Names	1
	On-screen Display Index	4
	Warning Indicators	6

<u>Preparation</u>	Attaching and Removing the Battery Pack	7
	Charging the Battery Pack	8
	Powering the Camcorder from an AC Outlet	9
	Inserting and Removing a Cassette	10
	Installing the Lithium Battery	11
	Selecting the Language for the On-screen Display	12
	Setting the Date and Time	13
	Attaching the Lens Hood	14
	Attaching the Wrist Strap	14
	Using the Lens Cap	14
	Tips on Recording Positions	15

<u>Basic Operations</u>	Camera Recording	
	Easy Camera Recording in Full Auto Mode	16
	Zooming	17
	Auto Focus	17
	Macro Shots	17
	Remaining Recording Time Display	18
	Remaining Battery Power Display	18
	Playback	
	Playback	19
	Volume Control	19
	Video Search	20
	Still	20
	Watching Playback on a TV	21

<u>Useful Features</u>	Using the Menu Screens	22
	Camera Recording	
	Displaying the Recording Guide	23
	Setting the Digital Zoom	24
	Gamma Brightness Compensation	25
	Gain-up	26
	Fade In and Fade Out	27
	Quick Return	28
	Edit Search	28

Useful Features	Still Recording	29
	Attaching the Supplied Tripod Adapter	29
	Wide Screen (16:9)	30
	Digital Image Stabilization (DIS)	30
	Self Recording	31
	Recording in LP (Long Play Recording) Mode	32
	Selecting the 16-bit Audio Recording Mode	33

Playback

	Using the Remote Control (Not supplied)	34
	Displaying the Date and Time of Recording	35
	Gamma Playback	35
	Picture Effect Playback	36

Advanced Features**Camera Recording**

	Manual Focus	37
	Manual Exposure	38
	White Balance Lock	39
	Setting the Camcorder to Full Auto Mode	39
	Digital Picture Effects	40
	Scene Menu (Program AE)	41

Playback

	Using the Time Code	42
	Editing	43
	Editing with the DV Terminal (IEEE1394)	44
	Audio Dubbing Feature	45
	Selecting the Audio Playback Mode	47

Appendix

	Picture/Backlight Adjustments	48
	Turning off the Confirmation Sound	49
	Useful Information	50
	Demonstration Mode	57
	Before Requesting Service	58
	Specifications	60

• Guía de operación rápida en español	61
• Visualizaciones en pantalla en español	68
• Affichages sur écran en français	69

Operation References

Part Names

For details on the use of each part, refer to the page number indicated in brackets.

Front view

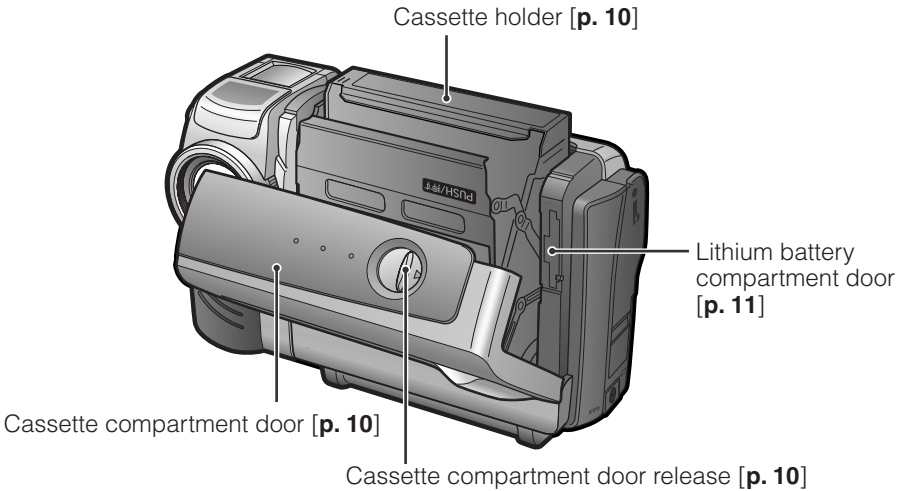
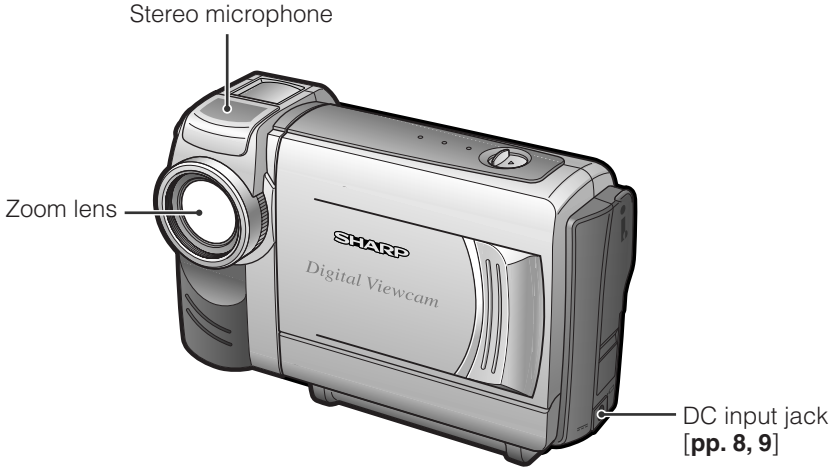

Rear view

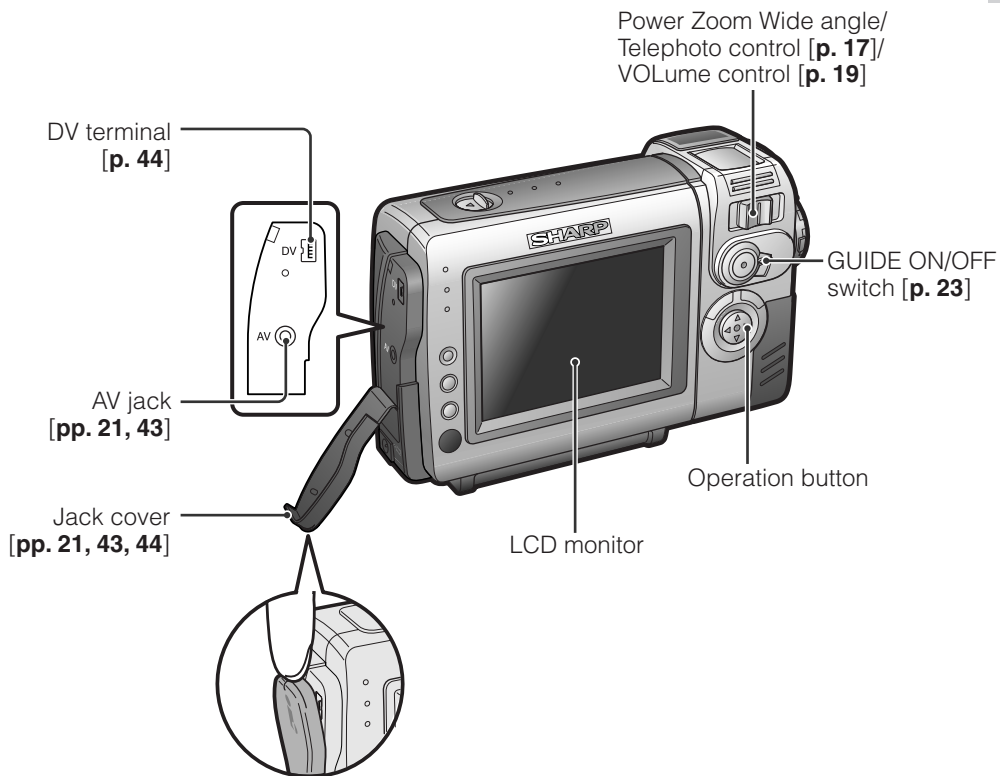

Operation References

Rear view

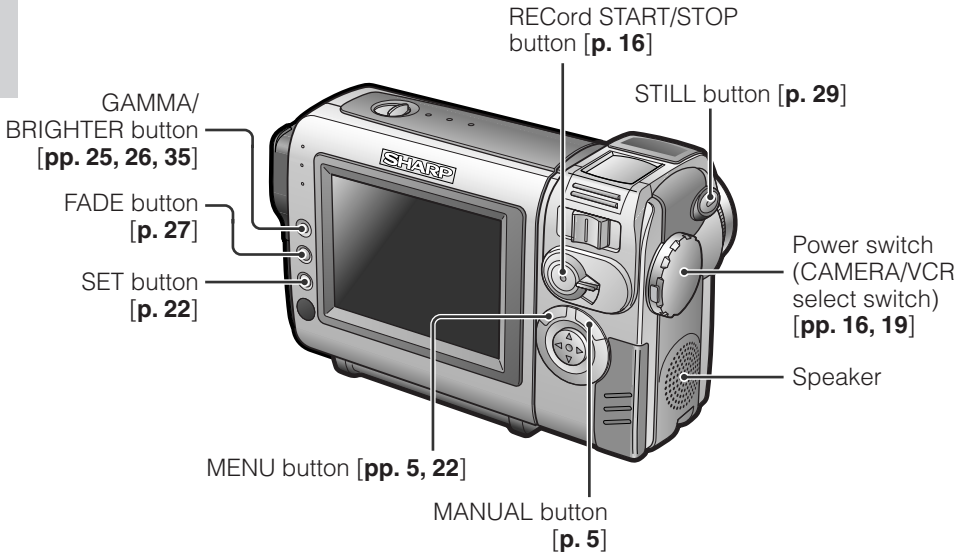

Bottom view

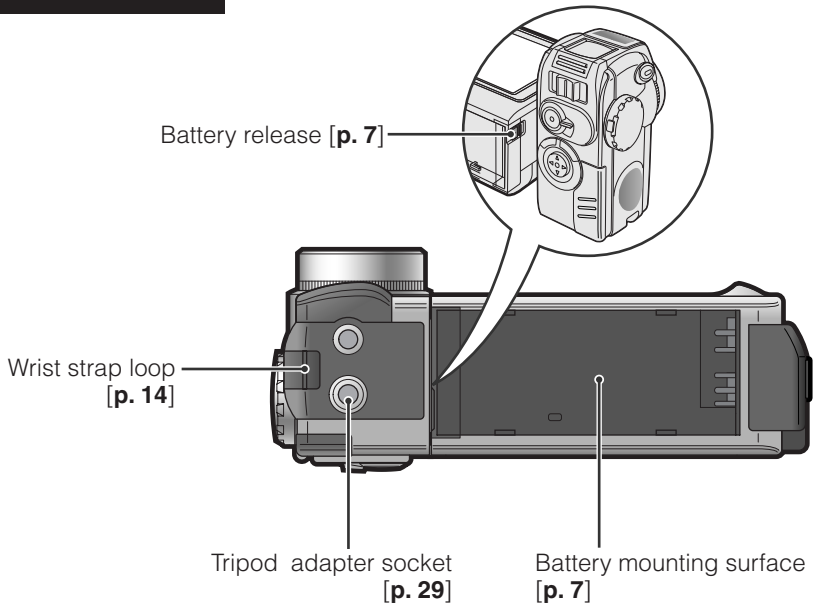

On-screen Display Index

For details on the use of each function, refer to the page number indicated.

CAMERA mode

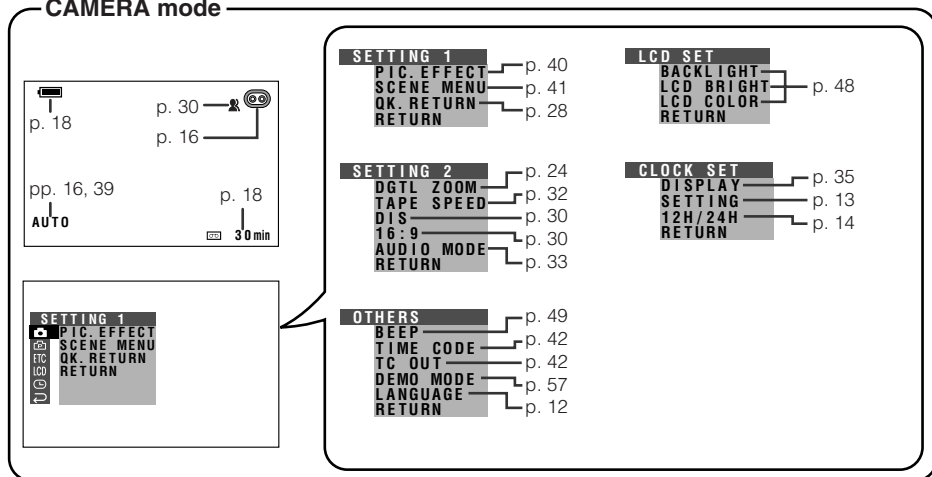

VCR mode

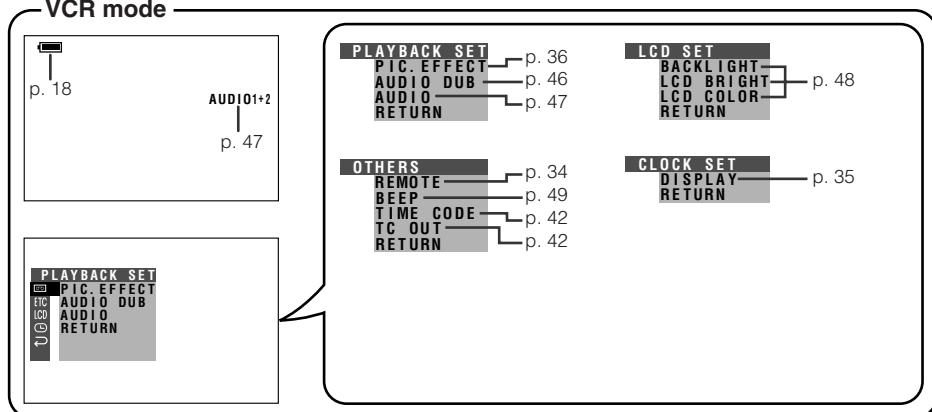

Note:

- See page 22 for procedures on how to display the desired screen.

Operation References

Manual screens

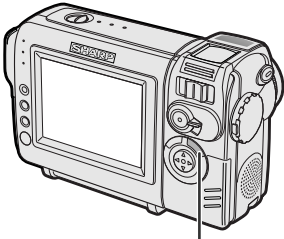

MANUAL button

Each time you press the MANUAL button, the screen changes as shown below.



On-screen indicators on/off

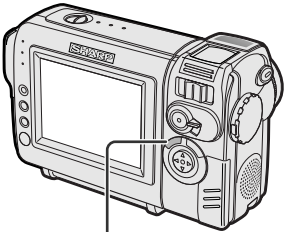

MENU button

Each time you press the MENU button, the screen changes as shown below.



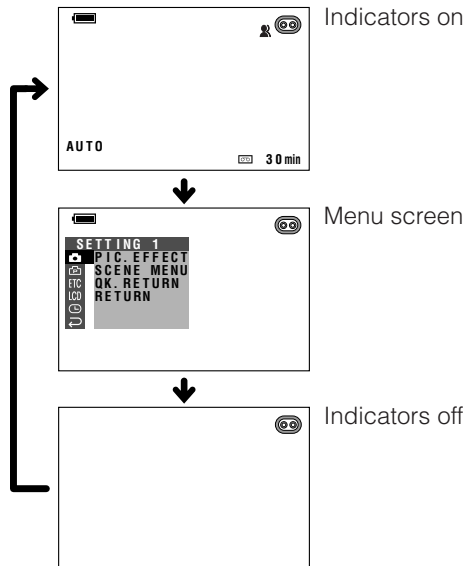



- The example screens shown are for CAMERA mode.

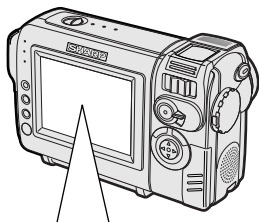

Warning Indicators

If a warning indicator appears on the screen, follow the specified instructions.



Displayed for the first 3 seconds	Displayed after 3 seconds	Description of warning
INSERT A CASSETTE.		There is no video cassette in the camcorder. Insert a cassette (see page 10).
EJECT THE CASSETTE.	EJECT THE CASSETTE.	The video cassette is defective and should be removed (see page 10).
CASSETTE NOT RECORDABLE.		The erasure protect tab on the video cassette has been slid to the record-protect position, preventing recording (see page 52).
THE TAPE ENDS SOON.		The tape is about to end. Prepare a new cassette (see page 10).
CHANGE THE CASSETTE.	TAPE END	The tape has reached the end. Replace it with a new cassette (see page 10).
BATTERY IS TOO LOW.		The battery is almost depleted. Replace it with a fully charged battery pack (see page 7).
DEW		Dew has formed inside the camcorder. Wait a few hours for the dew to dry away (see page 54). About 10 seconds after this warning appears, the camcorder automatically turns off.
		The video heads are clogged and should be cleaned (see page 55).
LAMP	LAMP	The fluorescent lamp behind the LCD monitor is close to the end of its service life. Call your local authorized Sharp dealer to have it replaced.

Note:

-  indicates a flashing display.

Preparation

Attaching and Removing the Battery Pack

Attaching

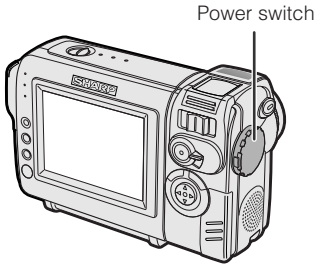

- 1 Make sure that the Power switch is set to OFF.



- 2 Align the mark on the side of the battery pack with the mark on the camcorder (1), and slide the battery pack in the direction of the arrow completely until it locks into place (2).

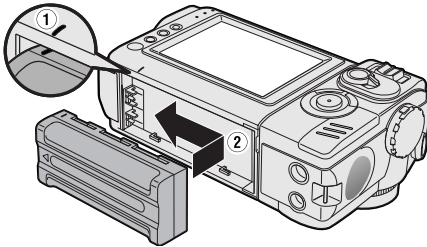

Removing

- 1 Make sure that the Power switch is set to OFF.
- 2 Rotate the monitor section of the camcorder (1), then press the battery release (2). Slide the battery pack in the direction of the arrow and take it out (3).

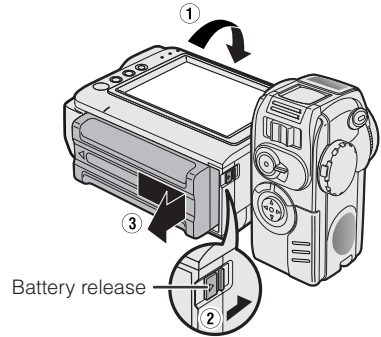

Cautions:

- **BEFORE REMOVING THE BATTERY PACK, ALWAYS STOP RECORDING OR PLAYBACK AND TURN THE POWER OFF.** Removing the battery pack while shooting or during playback may damage the tape by causing it to wrap around the video head drum.
- Remove the battery pack from the camcorder if you will not use the camcorder for a long period of time.
- Make sure that the battery pack is firmly attached during operation. If it is not, the battery pack may come off or camcorder operation may fall because of the poor contact pressure.
- To prevent damage to the battery pack when removing, be sure to firmly hold the battery pack while pressing the release.
- Use only SHARP model BT-L225 or BT-L445 battery packs with this camcorder. Use of other batteries may create a risk of fire or explosion.

Charging the Battery Pack

- 1 Attach the battery pack on the camcorder, and make sure that the Power switch is set to OFF.
- 2 Plug the AC adapter into a power outlet (①), then insert the DC plug into the DC input jack (②).
 - The charge indicator lights up.

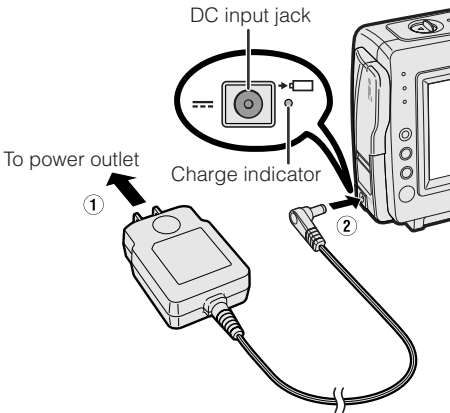

- The charge indicator turns off when the battery is charged.

- 3 Remove the DC plug from the DC input jack, then remove the AC adapter from the power outlet.

Charging time and maximum continuous recording and playback times

Battery pack	Charging time	Max. continuous recording time	Max. continuous playback time
BT-L225	approx. 2hr.	approx. 1hr. 30min.	approx. 1hr. 30min.
BT-L445	approx. 3hr. 30min.	approx. 3hr.	approx. 3hr.

Notes:

- Charge the battery pack between 50°F and 86°F (10°C and 30°C). The battery pack may not charge properly at temperatures too low or too high.
- The battery pack and charger become warm during charging. This is not a malfunction.
- Using the zoom (see page 17) and other functions or turning the power on and off frequently will increase power consumption. This may result in a decrease in the actual recording time compared to the maximum continuous recording time listed above.
- The charging time and recording time may vary depending on the ambient temperature and the condition of the battery pack.
- See page 53 for more information on using the battery pack.

Caution:

- Charge only SHARP model BT-L225 or BT-L445 battery packs. Other types of battery packs may burst, causing personal injury and damage.

Extending battery pack life

Even when the battery pack is not used, the capacity of the battery pack will naturally deteriorate over time. To limit the deterioration of the capacity, it is recommended to perform the following procedure at least once every six months:

- ① Fully charge the battery pack.
- ② Attach the battery pack to the camcorder, and set the Power switch to CAMERA without inserting a cassette. Allow the battery power to fully discharge by leaving it on the camcorder until the camcorder power automatically turns off.
- ③ Remove the battery pack and store it between 50°F and 68°F (10°C and 20°C).

Preparation

Powering the Camcorder from an AC Outlet

You can also power the camcorder from a power outlet by using the supplied AC adapter.

Caution:

- The supplied AC adapter is specially designed for use with this camcorder, and should not be used as a power supply for other camcorders.

- 1 Make sure that the Power switch is set to OFF.
- 2 Plug the AC adapter into a power outlet (①), then insert the DC plug into the DC input jack (②).
 - The camcorder is supplied power.

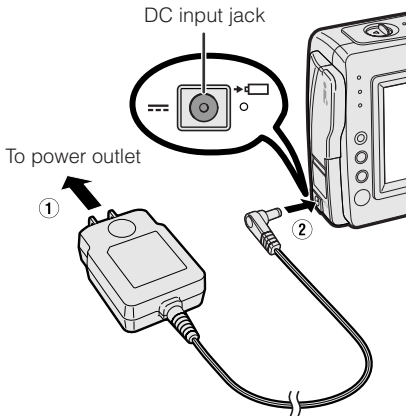

- 3 Hold down the Lock button and set the Power switch to CAMERA or VCR.

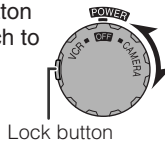

Note:

- When using the AC adapter to power the camcorder, the battery pack is not charged.

Cautions:

- **BEFORE REMOVING THE DC PLUG, ALWAYS STOP RECORDING OR PLAYBACK AND TURN THE POWER OFF.** Removing the DC plug while shooting or during playback may damage the tape by causing it to wrap around the video head drum.
- Disconnect the camcorder from the AC adapter if you will not use the camcorder for a long period of time.

Inserting and Removing a Cassette

Inserting

- 1 Attach the power source to the camcorder, then slide the cassette compartment door release and open the cassette compartment door.

- After confirmation sound, the cassette holder extends and opens automatically.

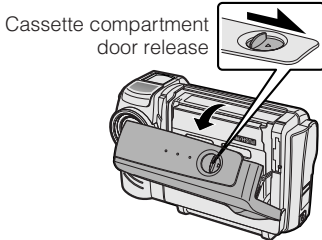

- 2 Insert a commercially available cassette fully with the window facing outwards, and with the erasure protect tab facing upwards.

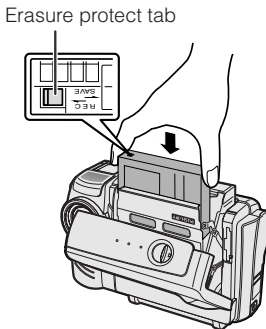

- 3 Press the **PUSH/押す** mark gently until the cassette holder clicks into place.

- After confirmation sound, the cassette holder retracts automatically.

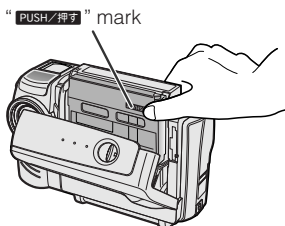

- 4 Wait for the cassette holder to fully retract. Close the compartment door by pressing the center until it clicks into place.

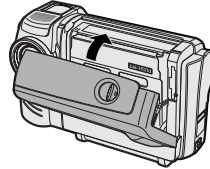

Removing

Perform step 1 above, then take out the cassette.

Cautions:

- Do not try to close the cassette compartment door while the cassette holder is extending or retracting.
- Be careful not to get your fingers caught in the cassette holder.
- Do not apply force to the cassette holder except when pressing the **PUSH/押す** mark to close it.
- Do not tilt the camcorder or hold it upside down when you are inserting or removing a cassette. It may damage the tape.
- Remove the cassette if you will not use the camcorder for a long period of time.
- If you do not correctly close the cassette holder in step 3, the cassette protection mechanism of the camcorder might eject the cassette. If this happens, repeat the insertion procedure.
- Do not attempt to pick up the camcorder by the cassette compartment door.

Notes:

- If the battery power is too low, you may not be able to eject the cassette. Replace the battery pack with a fully charged one.
- See page 52 for more information on the video cassette tapes intended for use with this camcorder.

Preparation

Installing the Lithium Battery

Installing

The supplied lithium battery is used to store the memory of the date and time settings.

- 1 Slide the cassette compartment door release and open the cassette compartment door.

Note:

- The cassette holder will extend and open when the camcorder is connected to a power source. Be sure to close the cassette holder before proceeding to the next step (see page 10).

- 2 Pull out the lithium battery holder using a pointed object such as the tip of a ballpoint pen.

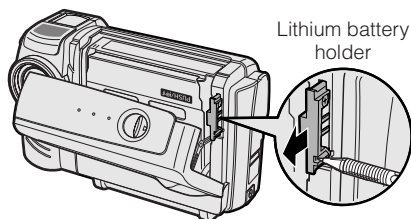

- 3 Insert the lithium battery into the battery holder with the + side of the battery facing the ⊕ side of the holder.

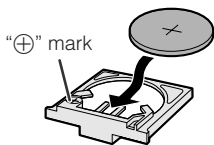

- 4 Push the battery holder back into position. Press the **PUSH/押す** mark gently, then close the cassette compartment door by pressing the center until it clicks into place.

Removing

Perform steps 1 and 2 above, then lift out the battery from the battery holder.

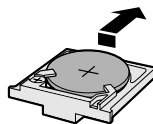

Notes on the Use of the Lithium battery

REPLACE BATTERY WITH TOSHIBA, MATSUSHITA OR HITACHI MAXELL TYPE CR2025 ONLY. USE OF A DIFFERENT BATTERY MAY PRESENT A RISK OF FIRE OR EXPLOSION.

WARNING KEEP THIS BATTERY AWAY FROM CHILDREN. IF SWALLOWED, CONSULT A PHYSICIAN IMMEDIATELY FOR EMERGENCY TREATMENT.

CAUTION BATTERY MAY EXPLODE IF MISUSED OR INSTALLED WITH POLARITY REVERSED. DO NOT RECHARGE, DISASSEMBLE OR DISPOSE OF IN FIRE.

- Do not short-circuit, recharge, disassemble, or heat the lithium battery.
- Should the lithium battery leak, wipe the battery compartment clean, and then insert a new battery.
- The lithium battery will last about one year under normal usage.

Selecting the Language for the On-screen Display

This camcorder allows you to choose English, French or Spanish as the on-screen display language.

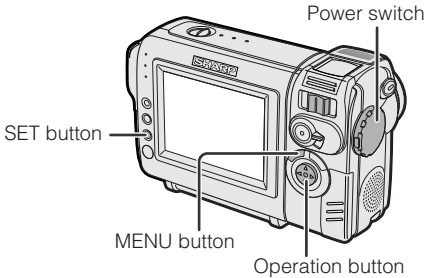

Setting

When using the camcorder for the first time, select your on-screen display language by following the steps below.

- 1 Hold down the Lock button and set the Power switch to CAMERA.
 - The language selection screen appears.
- 2 Press ∇ or Δ on the operation button to select the desired language, then press the SET button.

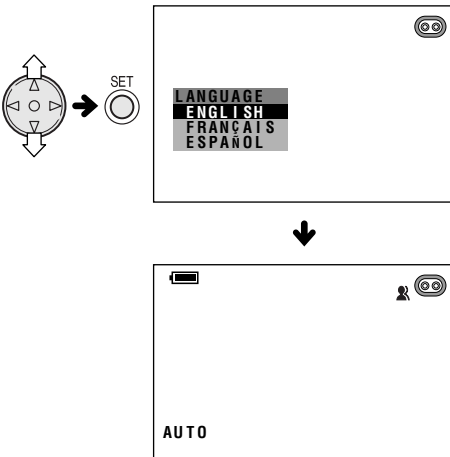

Changing

- 1 In CAMERA mode, press the MENU button until the menu screen appears.
- 2 Press ∇ or Δ on the operation button to select ETC, then press the SET button.
- 3 Press ∇ or Δ to select "LANGUAGE" ("LANGUE" or "IDIOMA"), then press the SET button.
 - The language selection screen appears.

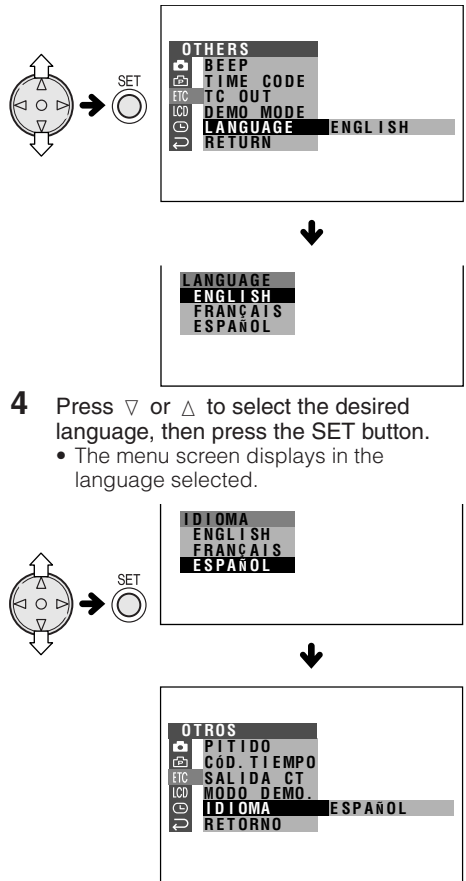

- 5 Press the MENU button to turn off the menu screen.

Note:

- The operation procedures in the following sections are based on using the English on-screen displays.

Setting the Date and Time

Example: Setting the date to June 2, 2003 (JUN. 2. 2003) and the time to 10:30 am (10:30 AM).

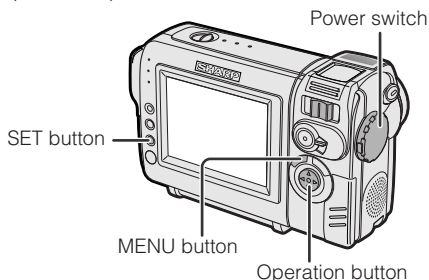

Note:

- Before performing the steps below, make sure that the lithium battery has been installed (see page 11).

1 Hold down the Lock button and set the Power switch to CAMERA.

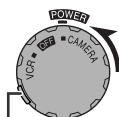

Lock button

2 Press the MENU button until the menu screen appears.

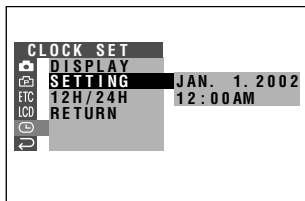

3 Press the SET button.



4 Press ∇ or Δ to select "JUN" (month), then press the SET button.



5 Press ∇ or Δ to select "2" (day), then press the SET button.



6 Press ∇ or Δ to select "2003" (year), then press the SET button.



7 Press ∇ or Δ to select "10 AM" (hour), then press the SET button.



8 Press ∇ or Δ to select "30" (minute), then press the SET button.

- The internal clock now starts operating.



9 Press the MENU button to turn off the menu screen.

Note:

- If the date and time have been set, the SETTING 1 screen (📷) appears in step 2. Select "SETTING" in the CLOCK SET screen (⏸) using the Operation button and SET button.

Changing to the 24-hour Time Mode

- After performing step 8 above, press ∇ or Δ to select "12H/24H", then press the SET button.

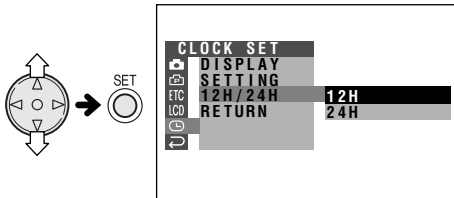

- Press ∇ or Δ to select "24H", then press the SET button.

12H/24H **24H**

- Press the MENU button to turn off the menu screen.

Notes:

- The date and time, once set, are internally recorded even when not displayed on the screen.
- The menu screen automatically turns off if no settings are made within five minutes.

Attaching the Lens Hood

When recording outdoors on a sunny day or in a location with bright lighting, attach the supplied lens hood to the camcorder. Turn the lens hood in the direction of the arrow to attach it.

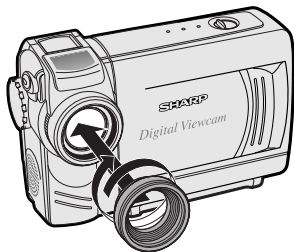

To remove it, turn it in the opposite direction.

Notes:

- The lens cap can still be attached on top of the lens hood.
- Filters and other accessories cannot be attached on the top of the lens hood.

Attaching the Wrist Strap

Attach the wrist strap to the wrist strap loop as shown below.

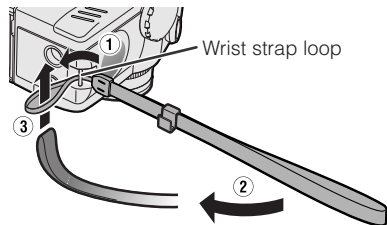

Caution:

- Do not swing the camcorder by the strap.

Using the Lens Cap

Attach the strap to the lens cap as shown below.

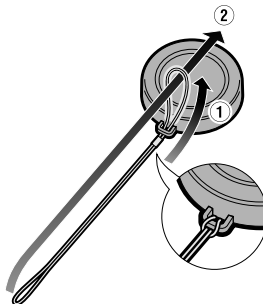

Attach the strap of the lens cap to the wrist strap as shown below.

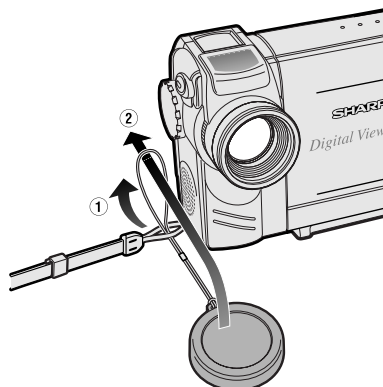

(Continued on the next page) **14**

Preparation

Always attach the lens cap over the lens when not using the camcorder.

Preparation

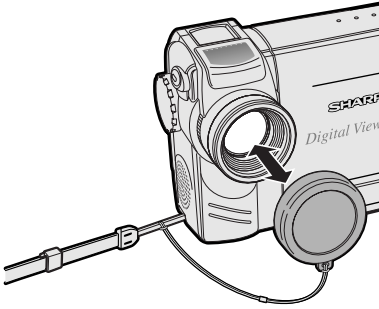

When recording, hang the lens cap on the wrist strap to keep the cap out of the way.

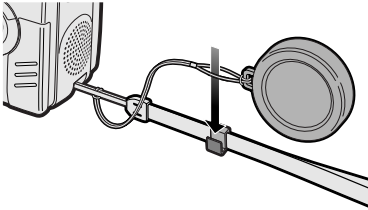

Tips on Recording Positions

To create images that are easy to watch during playback, try to record with an upright posture and steady hand to prevent a shaky image.

Holding the camcorder

Place your right thumb close to the REC START/STOP button and Power Zoom control. Place your left thumb on the thumb rest on the left side of the screen.

Basic posture

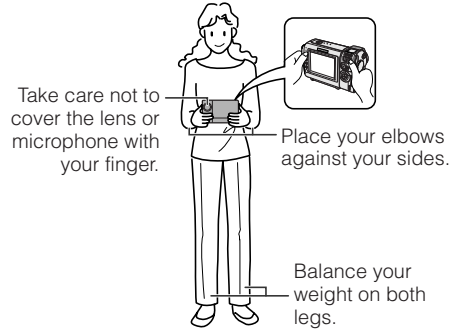

Shooting from a high angle

Turn the LCD monitor so that the screen faces downward.



Shooting from a low angle



Turn the LCD monitor so that the screen faces upward.

Basic Operations

Camera Recording

Easy Camera Recording in Full Auto Mode

- Before you start recording, perform the operations described on pages 7 through 15 to prepare your camcorder for recording.

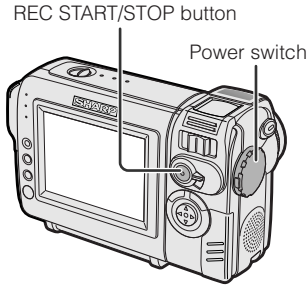

- 1 Remove the lens cap.
- 2 Hold down the Lock button and set the Power switch to CAMERA.
 - The picture from the lens now displays.
 - The camcorder is now ready to record (Recording Standby mode).

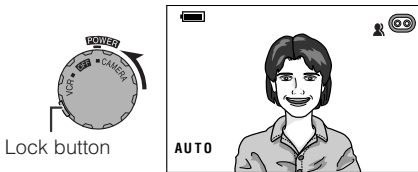

Note:

- If "AUTO" is not displayed at this time, set the camcorder to Full Auto mode (see page 39).

- 3 Press the REC START/STOP button to begin recording.

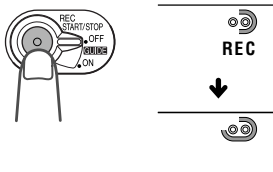

To pause recording

Press the REC START/STOP button again. Recording pauses, and the camcorder enters Recording Standby mode.

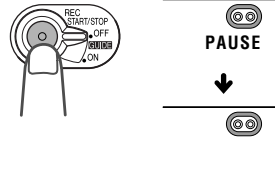

To turn the power off

Set the Power switch to OFF without pressing the Lock button.

Notes:

- Battery power is consumed in Recording Standby mode. Turn off the power if you will not be recording again soon.
- If the camcorder remains in Recording Standby mode for more than 5 minutes, the power will automatically turn off to save battery power and to protect the tape from being damaged. To resume recording, set the Power switch to OFF and then back to CAMERA. (The camcorder will make a confirmation sound when it is left in Recording Standby mode for about 4 minutes.)

Maximum continuous recording and actual recording times

Battery pack	Max. continuous recording time	Actual recording time
BT-L225	approx. 1hr. 30min.	approx. 50min.
BT-L445	approx. 3hr.	approx. 1hr. 40min.

Note:

- Using the zoom (see page 17) and other functions or turning the power on and off frequently will increase power consumption. This may result in a decrease in the actual recording time compared to the maximum continuous recording time listed above.

Basic Operations Camera Recording

Zooming

Zooming allows you to move visually closer to or farther from a subject without physically changing your position.

When using the optical zoom, you can enlarge the subject up to 10×.

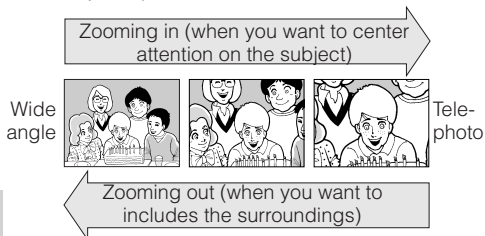

Zooming in

Push the Power Zoom control to the T (telephoto) side to get a close-up view (1).

Zooming out

Push the Power Zoom control to the W (wide angle) side to get a wide field of view (2).

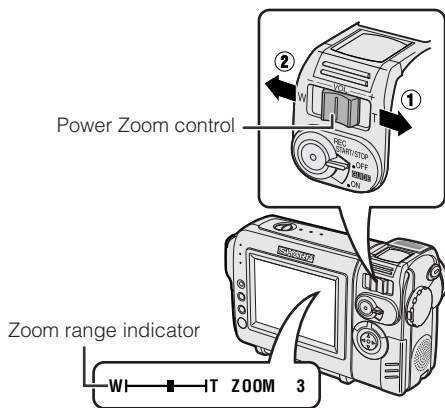

- The zoom range indicator shows you the current zoom setting.
- The zoom speed depends on how far you push the Power Zoom control.

Notes:

- The camcorder is unable to focus when zooming in on subjects within 5 feet (1.5 m). The camcorder will automatically zoom out until it is able to focus on the subject.
- See page 24 for how to use the digital zoom.

Auto Focus

The camcorder is preset to Auto Focus mode, which is designed to focus on most types of subjects. In Auto Focus mode, the camcorder automatically focuses on the subject in the center of the scene. Always keep the subject in the center of the scene.

Notes:

- If no subject is in the center of the scene, the focus area will expand and the subject nearest the center will be focused on.
- If no subject is displayed, the camcorder will automatically zoom out until a subject comes into the frame.
- Auto Focus may not work in the situations described on page 37. In these situations, use the manual focus function.

Macro Shots

This camcorder lets you shoot close-up images of small objects such as flowers and insects, or make title frames for your videos. When you want to record a magnified image of a subject which is within approximately 5 feet (1.5 m) of the camcorder, do not zoom in on it. Instead, zoom out all the way by pushing the Power Zoom control to the W side, and then move the camcorder closer to the subject until you obtain the desired angle of view. The camcorder will automatically focus on the subject when the lens is set for the widest angle.

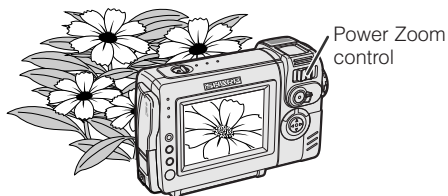

Note:

- When you are recording a macro shot, be sure that the subject receives sufficient illumination.

Remaining Recording Time Display

When the camcorder is recording, an on-screen indicator displays the approximate remaining tape time in minutes.

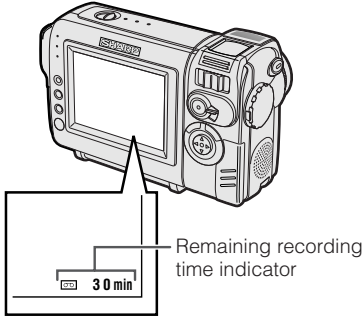

Notes:

- The remaining recording time indicator appears when the on-screen indicators turns on.
- The remaining recording time indicator appears 10 seconds after pressing the REC START/STOP button to begin recording.
- The remaining recording time indicator only shows the approximate time left. Also, it varies slightly depending on the length of tape used. (This function is based on the DVM60 tape standard.)

When the remaining recording time reaches 1 minute, a warning indicator will appear. Prepare a new cassette.

Warning indicator	Approx. remaining time
<p>THE TAPE ENDS SOON.</p> <p>↓</p> <p>TAPE END</p>	Less than 1 min.
<p>CHANGE THE CASSETTE.</p> <p>↓</p> <p>TAPE END</p>	The tape has reached the end.

Remaining Battery Power Display

When using the camcorder with the battery pack as the power source, the remaining battery power indicator is displayed. If the battery power becomes very low, a warning indicator appears. Replace the battery pack.

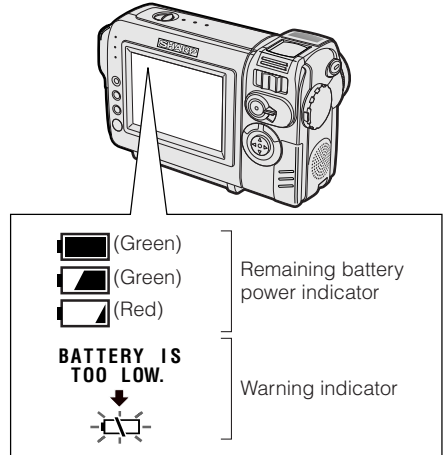

Notes:

- The remaining battery power indicator appears when the on-screen indicators turns on.
- Use the remaining battery power indicator only as an approximate indication.
- The remaining battery power indicator may change to either a higher or lower level if you set the Power switch to OFF and then back to CAMERA or VCR.
- In cold environments, the red remaining battery power indicator may appear sooner.
- Use of the zoom functions when the warning indicator is displayed may cause the camcorder to suddenly lose power.

Basic Operations

Playback

Playback

The LCD monitor screen functions as a handy playback monitor. Nothing needs to be connected, allowing instant on-screen playback with the sound through the built-in speaker.

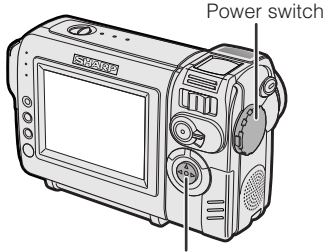

- 1 Hold down the Lock button and set the Power switch to VCR.

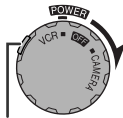

- 2 Press \triangleleft (or \triangleright) on the Operation button to rewind (or fast forward) the tape to the desired point.

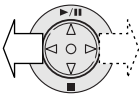

- 3 Press \triangle to begin playback.

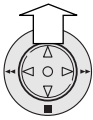

Note:

- If you press the REC START/STOP button in VCR mode, the “ Ⓢ ” mark appears and the camcorder enters Recording Standby mode. If you do not intend to record, press ∇ to turn the “ Ⓢ ” mark off, then press \triangle to begin playback. This will ensure your previous recording is not erased (see page 44).

To stop playback

Press ∇ .

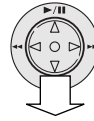

To turn the power off

Set the Power switch to OFF without pressing the Lock button.

Note:

- The tape is automatically rewound when playback reaches the end of the tape.

Volume Control

When the camcorder is in VCR mode, push the Volume control to the + or - side to increase (①) or decrease (②) the volume.

The volume level indicator will appear on the LCD screen during adjustment only. Once the Volume control is released, the volume level indicator will disappear shortly afterwards.

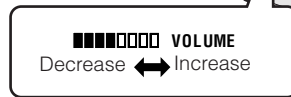
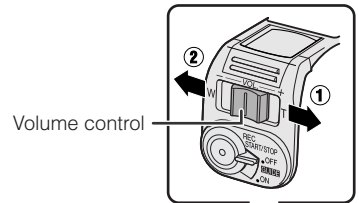

Speaker

Video Search

The video search function makes it easy to search for a desired scene on the tape.

Searching for a Scene Near the Current Tape Position

- 1 During playback, press \triangleright (or \triangleleft) on the Operation button.
 - The playback picture fast forwards (or reverses).

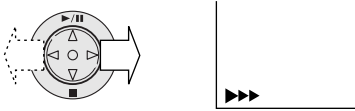

- 2 When you find the scene, press \triangle to return to normal playback.

Searching for a Scene Far from the Current Tape Position

- 1 During fast forward (or rewind), press and hold \triangleright (or \triangleleft) on the Operation button.
 - The fast forward (or rewind) picture displays.
- 2 If the scene is still rather far from the current tape position, release the Operation button to normal fast forward (or rewind).
- 3 Repeat steps 1 and 2 above until you find the scene.
- 4 Press \triangle to begin normal playback.

Notes:

- The sound is off during search.
- You may experience picture noise during search. This is not a malfunction.

Still

The still function allows you to pause playback.

During playback, press \triangle on the Operation button.

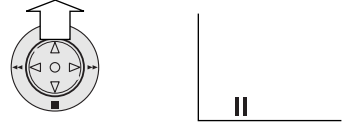

To return to normal playback, press \triangle again.

Notes:

- The sound is off in Still mode.
- To protect the tape, the camcorder automatically returns to normal playback if it is left in Still mode for more than 5 minutes.

Watching Playback on a TV

You can connect the camcorder to a TV to allow a larger audience to enjoy playback.

- 1 Open the jack cover on the camcorder (see page 2).

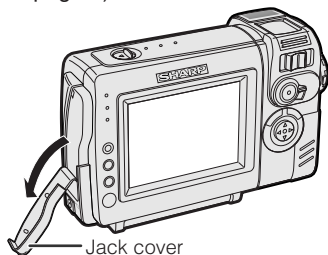

- 2 Connect the camcorder to your TV (or VCR) with the supplied audio/video cable, as shown.

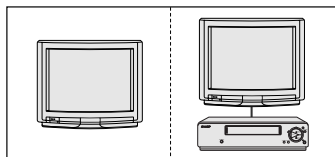

Yellow: To video input jack
White: To audio input (L) jack
Red: To audio input (R) jack

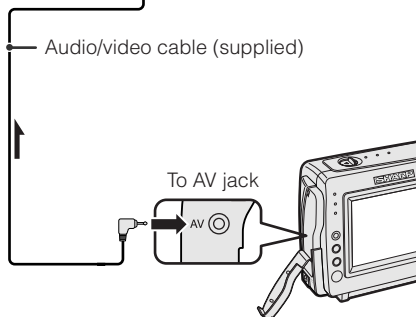

←: The arrow shows the signal flow.

Caution:

- Check that the camcorder, TV, VCR and other equipment to be used are turned off before making any connections. Picture noise or malfunction may occur if any of the above is left on while making a connection.

- 3 Turn on the TV and set it to the "AV" or "VIDEO" channel. (See the operation manual of your TV.)
 - When connecting to a TV via a VCR, turn on the VCR and set it to the "AV" or "LINE" input channel. Operate the TV as you normally do to view the signal from the VCR. (See the operation manuals of your TV and VCR.)
- 4 Set the Power switch on the camcorder to VCR, and begin playback (see page 19).

Notes:

- If your TV or VCR has only one audio input jack, use the white plug for the audio connection on the TV or VCR.
- Close the jack cover after use.

Useful Features

Using the Menu Screens

Use the menu screens to adjust the various camcorder settings.

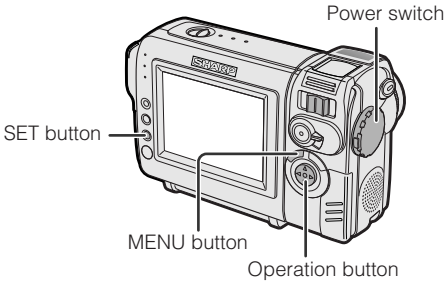

1 Set to the desired camcorder mode (CAMERA or VCR).

- See page 4 for the menu items you can select in each camcorder mode.
- Steps 2 to 5 show how to change the DGTL ZOOM menu setting in CAMERA mode.

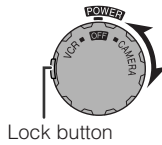

2 Press the MENU button until the menu screen appears.

Example

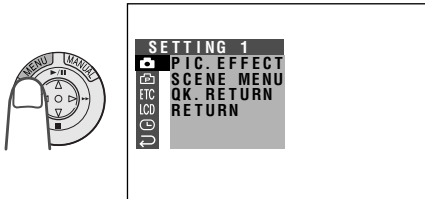

Note:

- The menu screen does not appear during recording.

3 Press ∇ or Δ on the Operation button to select the desired menu screen (r), then press the SET button.

Example



- You can press \triangleright , instead of the SET button.

4 Press ∇ or Δ to select the desired menu item (DGTL ZOOM), then press the SET button.

Example

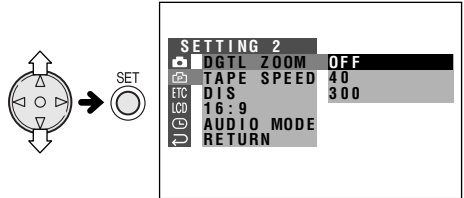

- You can press \triangleright , instead of the SET button.

5 Press ∇ or Δ to select the desired menu setting, then press the SET button.

DGTL ZOOM 40

- You can press \triangleright , instead of the SET button.
- To adjust another menu item, press ∇ or Δ to select "RETURN" and press the SET button, then perform steps 3 to 5.

To turn off the menu screen

Press the MENU button.

Notes:

- Certain menu items are common to all camcorder modes. If the BEEP menu item, for example, is set to "OFF" in CAMERA mode, it will be automatically set to "OFF" in VCR mode.
- The menu screen automatically turns off if no settings are made within five minutes.
- Items that are not selectable are grayed out.

Useful Features

Camera Recording

Displaying the Recording Guide

This function helps you decide on the size of the subject occupying the screen. Select one of five recording guides.

Types



Cross: A cross mark at the center of the screen for placing the subject at the center.



Focus: Focus brackets for guiding you to the focus area.

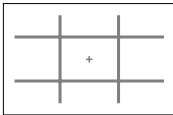

Landscape: Grid lines dividing the screen into 9 areas to help you with the horizontal and vertical composition.

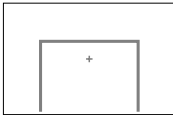

Snapshot: For capturing a small group of friends in a frame with surrounding background.

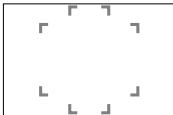

Portrait: Green frame fitting a full-body view and yellow frame fitting an upper-body view.

Turning on the recording guide

Set the GUIDE ON/OFF switch to ON.



Selecting the recording guide

Press ∇ or \triangle on the Operation button.

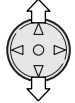

To turn off the recording guide

Set the GUIDE ON/OFF switch to OFF.



Note:

- When using manual focus, you cannot change the recording guide.

Setting the Digital Zoom

You can select three different zoom ranges: 1–10× (optical zoom), 10–40× (digital zoom) or 10–300× (digital zoom). The digital zoom allows you to record powerful close-up pictures with the same operation as normal zooming.

Notes:

- The digital zoom is in addition to the optical zoom giving a combined maximum zoom range of 1–300×.
- **As the image is enlarged digitally, the picture quality decreases when higher digital zoom settings are used.**

- 1 In CAMERA mode, press the MENU button until the menu screen appears.
- 2 Press ∇ or Δ on the operation button to select $\left[\text{D-ZOOM} \right]$, then press the SET button.
- 3 Press ∇ or Δ to select “DGTL ZOOM”, then press the SET button.

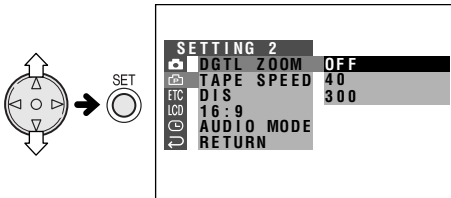

- 4 Press ∇ or Δ to select “40” or “300”, then press the SET button.

DGTL ZOOM 40

- 5 Press the MENU button to turn off the menu screen.

The “D” digital zoom indicator is displayed during digital zooming.

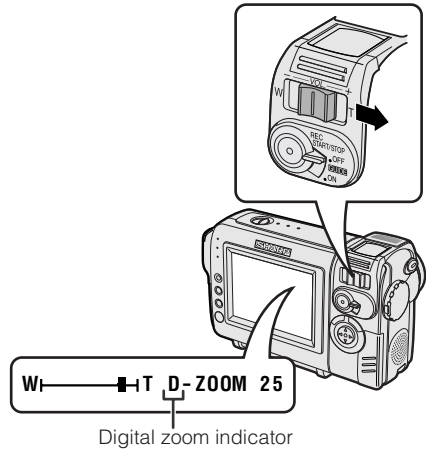

To use optical zoom only

Select “OFF” in step 4 above.

Useful features

Camera Recording

Gamma Brightness Compensation

When the subject is backlit, the image will appear dark if it is recorded normally. The gamma brightness compensation function improves the picture by increasing the brightness of the subject while leaving the brighter portion of the image unaffected.

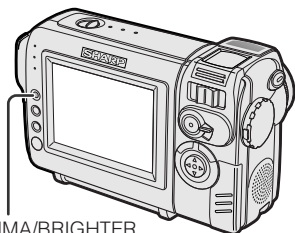

GAMMA/BRIGHTER button

In CAMERA mode, press the GAMMA/BRIGHTER button once.

- "GAMMA" appears, indicating that Gamma Brightness Compensation is now working.

GAMMA / BRIGHTER

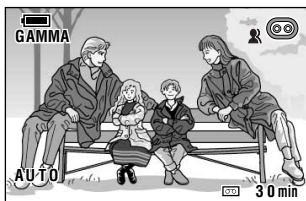
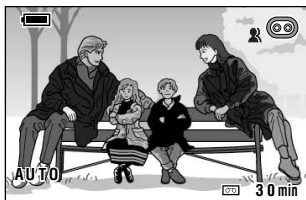

To obtain a brighter picture

Press the GAMMA/BRIGHTER button again.

- The  indicator appears.

GAMMA / BRIGHTER

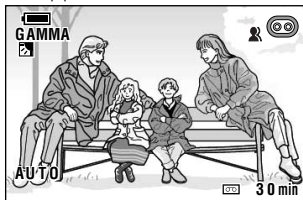

Note:

- When the  indicator is displayed, the background will become slightly brighter.

To cancel Gamma Brightness Compensation

Press the GAMMA/BRIGHTER button until "GAMMA" disappears.

Gain-up

When you are recording in a dark or poorly illuminated location, "LIGHT" is displayed on the screen. Use the gain-up function to record a brighter picture.

Note:

- At locations where lighting is adequate, "LIGHT" will not appear. The gain-up function cannot be used in this case.

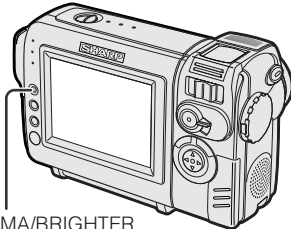

GAMMA/BRIGHTER button

In CAMERA mode, press the GAMMA/BRIGHTER button once.

- "GAMMA" appears, indicating that the gain-up function is now working.

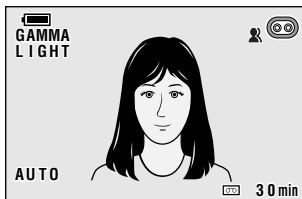
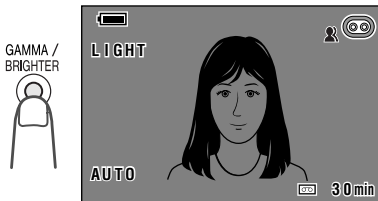

To obtain a brighter picture

Press the GAMMA/BRIGHTER button again.

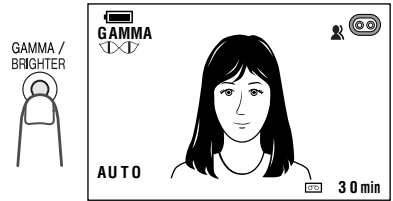

- The  indicator appears.



To cancel the gain-up function

Press the GAMMA/BRIGHTER button until "GAMMA" disappears.

Notes:

- You may experience some picture noise in Gain-up mode, which increases when the  displays.
- When the  indicator displays, you may get a shadow image behind a subject that is moving around a lot.
- Fine brightness adjustments are possible when using manual exposure (see page 38).
- Gain-up will cancel if you aim the camcorder in a bright location.

Useful Features

Camera Recording

Fade In and Fade Out

The fade function allows you to gradually bring the image and sound in or out at the beginning or end of a scene for creating scene transitions. This is especially effective in creating a dramatic change in scenery.

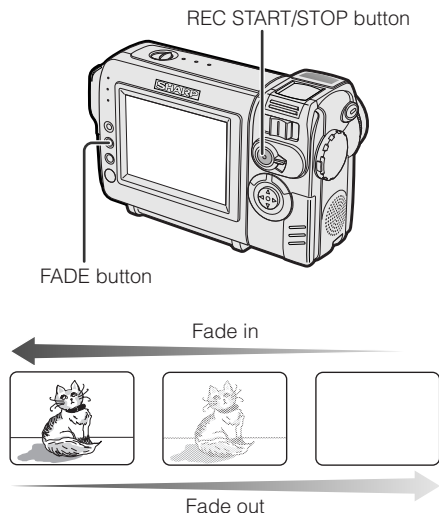

Using

- 1 In CAMERA mode, press the FADE button.
 - "FADE" appears.

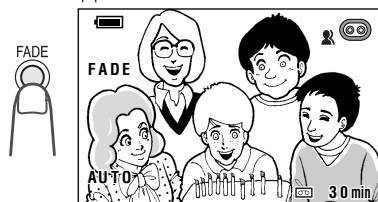

- 2 Press the REC START/STOP button to begin recording.

- The picture turns white, and the image and sound fade in.

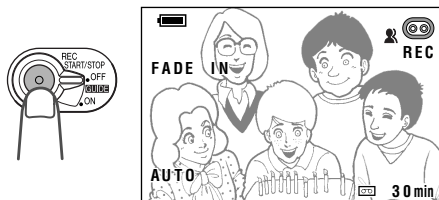

- 3 Press the REC START/STOP button at the point where you wish to stop recording.

- The image and sound fade out as the picture gradually turns white. The camcorder then returns to Recording Standby mode.

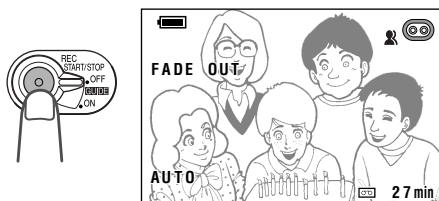

To cancel Fade mode

Press the FADE button again in Recording Standby mode.

To use Fade Out only

- 1 During camera recording, press the FADE button to display "FADE".
- 2 Press the REC START/STOP button at the point where you wish to stop recording.

Note:

- Fade mode automatically cancels after Fade Out.

Quick Return

If while playing back your tape you want to quickly return to the last recorded scene and start recording again, use the quick return function.

- 1 In Recording Standby mode, press the MENU button until the menu screen appears.
- 2 Press ∇ or Δ on the operation button to select , then press the SET button.
- 3 Press ∇ or Δ to select "QK. RETURN", then press the SET button.

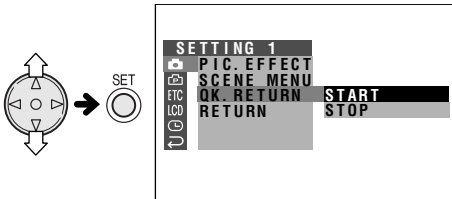

- 4 Press ∇ or Δ to select "START", then press the SET button.
 - "SEARCH" flashes, and the tape begins fast forwarding or rewinding to the end of the last recorded scene.



- When the tape reaches the end of the last recorded scene, "FINISHED" is displayed, and the camcorder enters Recording Standby mode.

- 5 Press the MENU button to turn off the menu screen.

Notes:

- To cancel the quick return function while "SEARCH" is flashing, press the SET button twice.
- Quick return will not work if you remove the cassette and reload it after recording or if nothing has been recorded since loading.

Edit Search

The edit search function lets you search, without switching from CAMERA mode to VCR mode, for the point on the tape where you wish to start recording next.

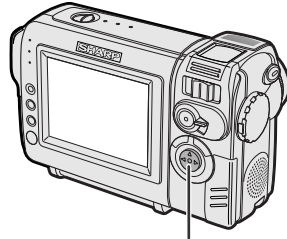

Operation button

- 1 In Recording Standby mode, press and hold down \triangleleft (reverse edit search) or \triangleright (forward edit search) on the Operation button.

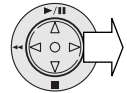
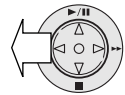

- 2 When you find the point where you want to begin recording, release the button.

Notes:

- The sound is off during search.
- Forward edit search is performed at the same speed as normal playback, and reverse edit search at 5.5 times the normal playback.
- You may experience picture noise during reverse edit search.

Still Recording

You can record continuous still images of subjects.

- 1 In Recording Standby mode, press the STILL button fully.
 - A still image of the subject is displayed.



- 2 Press the REC START/STOP button.
 - The still image of the subject will be recorded.



To pause recording

Press the REC START/STOP button.

To cancel the still image

Press the STILL button fully.

Notes:

- Still Recording can also be used during recording by pressing the STILL button fully.
- The picture quality in Still Recording function will be slightly lower than normal pictures.

Attaching the Supplied Tripod Adapter

Attach the supplied tripod adapter when using a tripod with the camcorder.

- 1 Align the tripod adapter with the tripod adapter socket on the bottom of the camcorder, then rotate as shown below.

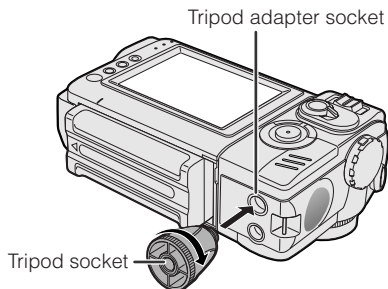

- 2 Attach tripod to tripod socket.





Note:

- You cannot use the supplied tripod adapter, if the alignment pin is not retractable.

Wide Screen (16:9)

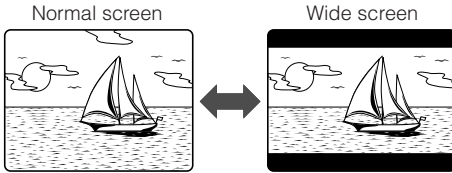
The wide screen function lets you record scenes with the wide-screen feel of a movie shown in a theater. The top and bottom of the picture are masked with black bands to produce an effective screen aspect ratio of 16:9.



- 1 In CAMERA mode, press the MENU button until the menu screen appears.
- 2 Press ∇ or Δ on the operation button to select , then press the SET button.
- 3 Press ∇ or Δ to select "16:9", then press the SET button.

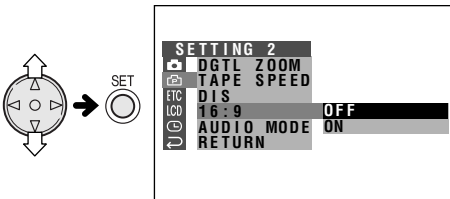

- 4 Press ∇ or Δ to select "ON", then press the SET button.
 - The picture is displayed with the top and bottom portions masked.

16:9 ON

- 5 Press the MENU button to turn off the menu screen.

To return to normal screen

Select "OFF" in step 4 above.

Digital Image Stabilization (DIS)

The digital image stabilization (DIS) function allows you to stabilize the image by electronically compensating for relatively minor image shaking that is often annoying in close-up shots.

- 1 In CAMERA mode, press the MENU button until the menu screen appears.
- 2 Press ∇ or Δ on the operation button to select , then press the SET button.
- 3 Press ∇ or Δ to select "DIS", then press the SET button.

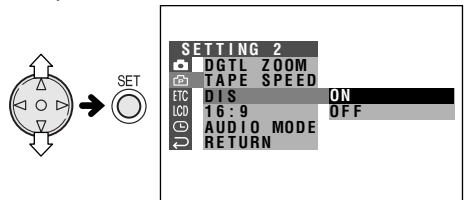

- 4 Press ∇ or Δ to select "ON", then press the SET button.

DIS ON

- 5 Press the MENU button to turn off the menu screen.
 - The DIS indicator only appears when the on-screen indicators are turned on.



To cancel DIS function

Select "OFF" in step 4 above. The  indicator will disappear.

Notes:

- The DIS function cannot compensate for excessive image shaking.
- When image shaking does not occur (e.g. when using the camcorder on a tripod), turn off the DIS function. The picture will appear more natural when the DIS function is off.

Useful Features

Camera Recording

Self Recording

Rotate the LCD monitor 180° vertically so that the screen faces the other way and the subject can monitor the shot while you are recording.

If the camcorder is steadied, you can record yourself in the scene by watching yourself on the LCD monitor.



- 1 Set the Power switch to CAMERA.
- 2 Rotate the monitor section 180° vertically.
 - A mirror image of the subject displays on the LCD monitor.

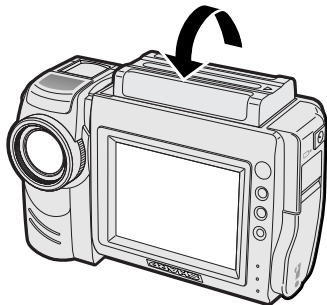

- 3 Press the REC START/STOP button to begin recording.

Cautions:

- Do not rotate the monitor section to the self recording position during recording or playback.
- **For recording in Self Recording mode, be sure to rotate the monitor section, NOT the lens section. If you hold the camcorder upside down with the lens at the bottom, the subject will be recorded upside down.**

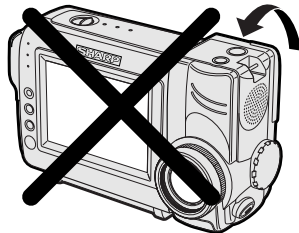

More Information on Self Recording

- The screen image automatically inverts when the monitor rotation is between 135° and 200°. When the monitor section is turned back to the normal position, the image returns to normal.
- You can play back images while the monitor is in the self recording position. Set the camcorder to VCR mode. The Operation button still retains its function as during normal playback, for example, Δ on the Operation button works as the Play button.

Recording in LP (Long Play Recording) Mode

This camcorder allows you to record in LP (Long Play Recording) mode for approximately 50% more recording time with the same picture quality as that in SP (Standard Play Recording) mode.

- 1 In CAMERA mode, press the MENU button until the menu screen appears.
- 2 Press ∇ or Δ on the operation button to select , then press the SET button.
- 3 Press ∇ or Δ to select "TAPE SPEED", then press the SET button.

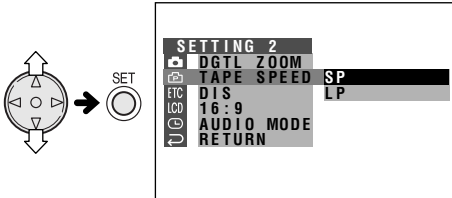

- 4 Press ∇ or Δ to select "LP", then press the SET button.

TAPE SPEED LP

- 5 Press the MENU button to turn off the menu screen.
 - The long play recording mode indicator only appears when the on-screen indicators are turned on.



Long play recording mode indicator

To return to SP mode

Select "SP" in step 4 above.

Notes on the use of LP mode

- To record in LP mode, be sure to use a Mini DV cassette labeled for use with LP mode.
- Frozen images, mosaic-pattern picture noise, audio interruptions or audio loss may occur in the following cases:
 - When using a tape which is not designated for use with LP mode.
 - When a tape recorded in LP mode under high temperature conditions is played back.
 - When a tape recorded in LP mode with the camcorder is played back on a Mini DV player or camcorder from another manufacturer.
 - When a tape recorded in LP mode is played back on a Mini DV player or camcorder without an LP function.
- Audio dubbing is not possible with LP mode recording.

Selecting the 16-bit Audio Recording Mode

The camcorder normally records audio in the 12-bit audio recording mode. For higher-quality audio recording, select the 16-bit audio recording mode.

- 1 In CAMERA mode, press the MENU button until the menu screen appears.
- 2 Press ∇ or Δ on the operation button to select , then press the SET button.
- 3 Press ∇ or Δ to select "AUDIO MODE", then press the SET button.

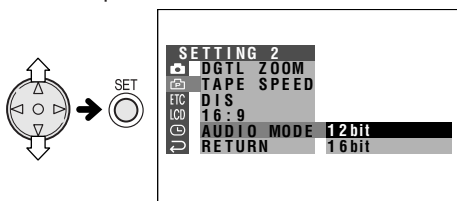

- 4 Press ∇ or Δ to select "16bit", then press the SET button.

AUDIO MODE 16 bit

- 5 Press the MENU button to turn off the menu screen.
 - The 16-bit audio recording mode indicator only appears when the on-screen indicators are turned on.

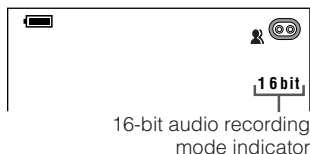

To return to 12-bit audio recording mode

Select "12bit" in step 4 above.

Note:

- When using Audio Dubbing with 16-bit audio recordings, both the dubbed and original sounds will be recorded in mono (see page 45).

Useful Features

Playback

Using the Remote Control (Not supplied)

The remote control (RRMCG0084TASA) is not supplied with this camcorder. Contact the nearest SHARP service center or your dealer for purchasing as a specified part.

Installing the Batteries

- 1 Open the battery compartment cover.
- 2 Insert the two commercially available AA (R6 or UM/SUM-3) batteries with the battery poles positioned as indicated.

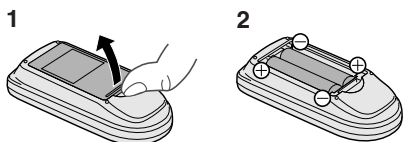

- 3 Place the cover.

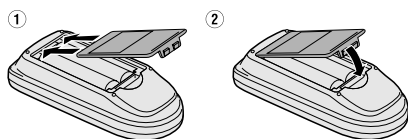

Activating

- 1 In VCR mode, press the MENU button until the menu screen appears.
- 2 Press ∇ or Δ on the operation button to select ETC, then press the SET button.
- 3 Press ∇ or Δ to select "REMOTE", then press the SET button.

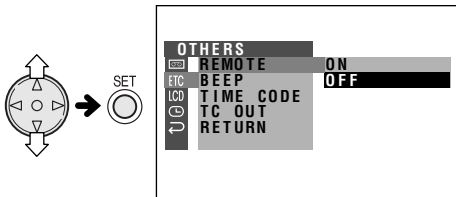

- 4 Press ∇ or Δ to select "ON", then press the SET button.

REMOTE ON

- 5 Press the MENU button to turn off the menu screen.

Operating

Aim the remote control at the remote sensor of the camcorder, and press the control buttons to operate.

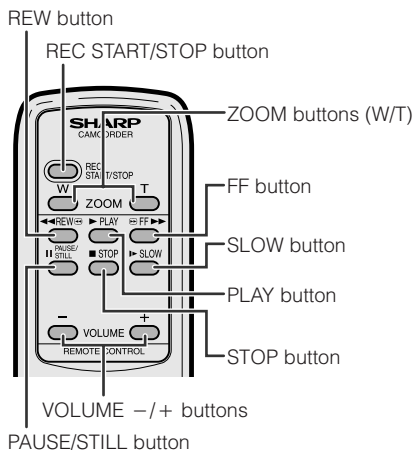
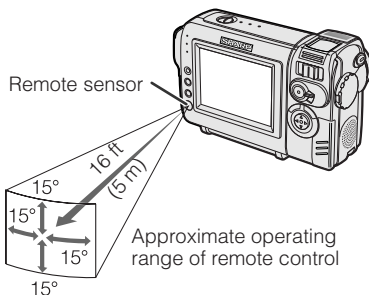

Notes:

- Do not use old and new batteries together or batteries of different brands together.
- Be careful not to expose the remote sensor to direct sunlight or strong interior lighting, as this may prevent the remote control from operating properly.
- Be sure that there are no obstacles between the remote control and the remote sensor.

Useful Features Playback

Displaying the Date and Time of Recording

Follow the procedure below to display the date, or both the date and time, of recording on the screen. You can display the date and time during both recording and playback.

- The example screens shown are for CAMERA mode.
- 1 Press the MENU button until the menu screen appears.
 - 2 Press ∇ or Δ on the operation button to select ☰ , then press the SET button.
 - 3 Press ∇ or Δ to select "DISPLAY", then press the SET button.

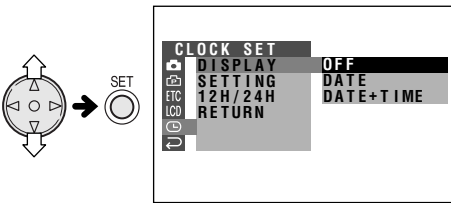

- 4 Press ∇ or Δ to select "DATE" or "DATE + TIME", then press the SET button.

DISPLAY **DATE+TIME**

- 5 Press the MENU button until the date (or date and time) displays.



Notes:

- **The date (or date and time) appears when the on-screen indicators are turned on.**
- Before recording, make sure that the date and time have been correctly set. If they have not been set, the display will be left blank when playing back the recording. (The display will also be left blank for unrecorded or damaged portions of the tape.)
- In VCR mode, the current date and time are displayed when the tape is not being played back.

Gamma Playback

The gamma playback function improves the playback picture in VCR mode by increasing the brightness of the subject while leaving the brighter portions of the image unaffected.

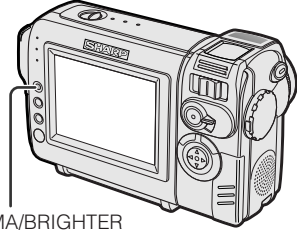

GAMMA/BRIGHTER button

During playback, press the GAMMA/BRIGHTER button once.

- "GAMMA1" appears, and the picture becomes brighter.

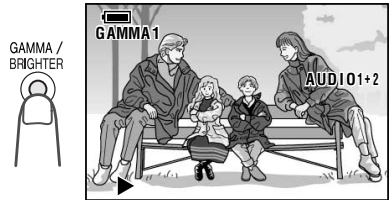

To obtain a brighter picture, press the GAMMA/BRIGHTER button again.

- "GAMMA2" appears.

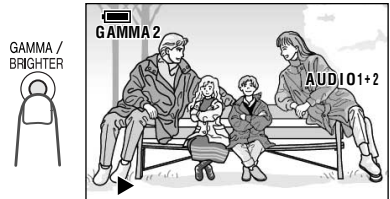

To cancel Gamma Playback

Press the GAMMA/BRIGHTER button until "GAMMA1" and "GAMMA2" disappear.

Note:

- **Gamma Playback has no effect during still playback.**

Picture Effect Playback

These picture effects let you play back images with a more dramatic effect.

Types

B/W: The picture is displayed in black-and-white.

SEPIA: The picture is displayed in sepia color similar to that of an old photograph.

SOLARI: The contrast of the subject is enhanced, creating a unique artistic image.

NEGA: The blacks and whites of the image are reversed and colors of the image are inverted.

BLUE: The picture is displayed with the effect of playback through a blue filter.

- 1 During playback, press the MENU button until the menu screen appears.
- 2 Press ∇ or Δ on the operation button to select , then press the SET button.
- 3 Press ∇ or Δ to select "PIC. EFFECT", then press the SET button.

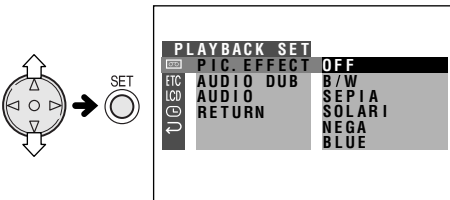

- 4 Press ∇ or Δ to select the desired picture effect, then press the SET button.

PIC. EFFECT B/W

- 5 Press the MENU button to turn off the menu screen.

To cancel Picture Effect Playback

Select "OFF" in step 4 above.

Note:









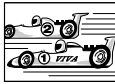

- Images in Picture Effect Playback mode cannot be transferred via DV cable to a personal computer.

Advanced Features

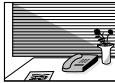
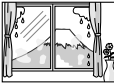
Camera Recording

Manual Focus

Auto Focus may not be able to focus on the subject in the situations shown below. In such situations, set the camcorder to Manual Focus mode and focus manually.

 Subject is too dark.	 Lack of contrast, e.g. snow scene.
 Fast-moving subject.	 Background is too bright.
 Subject has horizontal stripes.	 Subject is being shot through a dirty or wet window.
 Light reflects off the subject.	 Two subjects at different distances overlap in the same scene.
 Subject has fine, repeated patterns.	 Subjects at different distances appear in the center of the scene at the same time.
 Fast-speed shutter being used under fluorescent lighting.	

- In CAMERA mode, press the MANUAL button until the focus setting screen appears.



AUTO
MAN. FOCUS AUTO

- Adjust the Power Zoom control to frame the subject as you desire.

- Press Δ or ∇ to focus on the subject.
 Δ : To focus on a more distant subject
 ∇ : To focus on a closer subject



MF
MAN. FOCUS MANUAL

- Press the MANUAL button until the normal screen appears.
 - "MF" appears.



Manual focus indicator

To return to Auto Focus mode

Press the SET button while the focus setting screen is displayed.

Notes:

- The camcorder may not be able to focus correctly if the subject is closer than approximately 5 feet (1.5 m). Set the zoom control to wide angle, and try refocusing again.
- If the lens is dirty or fogged, the camcorder may not be able to focus correctly.
- When "MF" is displayed, you can manually adjust the focus by pressing ∇ or Δ , even if the focus setting screen is not displayed.

Manual Exposure

The camcorder is preset to Auto Exposure mode, which automatically selects the optimal aperture. However, when there is too much contrast in brightness between the subject and background, you may not be able to record a clear image. In this case, use the manual exposure function to correct the exposure level.

Background is too bright and subject too dark (backlit subject).

- Increase the exposure level to allow more light through the lens.

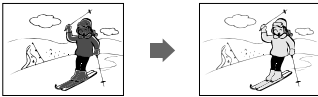

Subject is too bright against background.

- Decrease the exposure level to allow less light through the lens.



- 1 In CAMERA mode, press the MANUAL button until the exposure setting screen appears.



- 2 Press Δ or ∇ to select the desired exposure level.

- The number shown is the selected exposure level. The adjustment range is from -5 (least light) to $+5$ (most light).

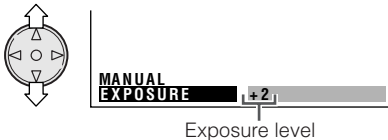

- 3 Press the MANUAL button until the normal screen appears.

To return to Auto Exposure mode

Press the SET button while the exposure setting screen is displayed.

Note:

- Manual Exposure mode will cancel if a scene setting is selected thereafter.

White Balance Lock

The color of the subject on the screen looks different depending on lighting conditions. Lock the White Balance if the Auto White Balance does not work properly.

- 1 In CAMERA mode, press the MANUAL button until the white balance setting screen appears.



- 2 Aim the lens at a white object.
 - Adjust the distance of the object so that the entire screen is white.

White paper or white cloth

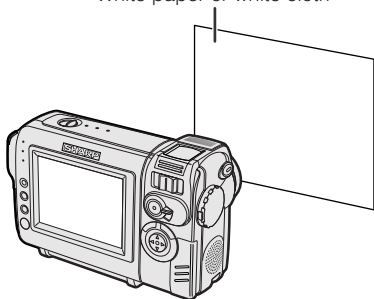

- 3 Press the SET button to set the white balance lock.
 - "LOCK" flashes during the locking procedure.



Note:

- If you move the camcorder while "LOCK" is flashing, "LOCK" may not stop flashing. If this occurs, press the SET button to cancel the procedure, and then repeat step 3.

- 4 Press the MANUAL button until the normal screen appears.

To return to Auto White Balance mode

Press the SET button while the white balance setting screen is displayed.

Note:

- White Balance setting will cancel if a scene setting is selected thereafter.

Setting the Camcorder to Full Auto mode

To easily record good-quality images, perform camera shooting in Full Auto mode. If "AUTO" is not displayed on the screen, the camcorder is in Manual mode. Perform the procedure below to cancel all manual settings and set the camcorder to Full Auto mode.

In CAMERA mode, press and hold down the MANUAL button for 2 second.

- "FULL AUTO" flashes, then stop flashing when the camcorder is set to Full Auto mode.



Digital Picture Effects

These digital picture effects let you record the subject with a more dramatic effect.

Types

B/W: To record in black-and-white.

SEPIA: To record in sepia color similar to that of an old photograph.

SOLARI: To record with enhanced contrast, creating a unique artistic image.

NEGA: To record a picture whose blacks and whites of the image are reversed and colors of the image are inverted.

BLUE: To record with the effect of recording through a blue filter.

- 1 In CAMERA mode, press the MENU button until the menu screen appears.
- 2 Press ∇ or Δ on the operation button to select , then press the SET button.
- 3 Press ∇ or Δ to select "PIC. EFFECT", then press the SET button.

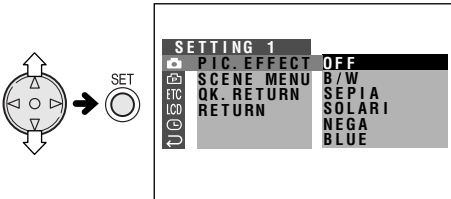

- 4 Press ∇ or Δ to select the desired digital picture effect, then press the SET button.

- The selected digital picture effect displays on the menu screen.

PIC. EFFECT B/W

- 5 Press the MENU button to turn off the menu screen.

To cancel the digital picture effect

Select "OFF" in step 4 above.

Note:

- Digital picture effects cannot be used when a still image is displayed.

Scene Menu (Program AE)

You can set the camcorder to the shooting mode that will create the best results for a specific situation. Just select one of four scene settings shown below. The camcorder will automatically set the exposure, white balance, and shutter speed to produce the optimum picture quality for the selected situation.

Types

SPORT: When you want to record a fast-moving subject.

SUNLIGHT: When the background is very bright.

DUSK: When you want to faithfully record the red of the setting sun, and the surrounding twilight.

PARTY: When the illumination is from a spotlight or candle.

- 1 In CAMERA mode, press the MENU button until the menu screen appears.
- 2 Press ∇ or Δ on the operation button to select , then press the SET button.
- 3 Press ∇ or Δ to select "SCENE MENU", then press the SET button.

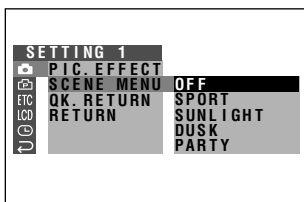
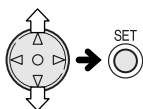

- 4 Press ∇ or Δ to select the scene setting that best fits the recording situation, then press the SET button.
 - The selected scene setting displays on the menu screen.

SCENE MENU SPORT

- 5 Press the MENU button to turn off the menu screen.
 - The selected scene setting indicator displays when the on-screen indicators are turned on.



Scene setting indicator

To cancel the scene setting

Select "OFF" in step 4 above.

Note:

- Scene settings cannot be used when displaying a still image.

Advanced Features

Playback

Using the Time Code

The time code shows the hour, minute and second of recording, and the frame number (1 frame = approx. 1/30 sec.). This is automatically recorded along with the subject when you are recording on the tape. You can display the time code on the screen as an accurate counter in both VCR and CAMERA modes.

Display format

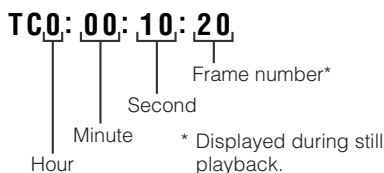

• The example screens shown are for VCR mode.

- 1 During playback or camera recording, press the MENU button until the menu screen appears.
- 2 Press ∇ or Δ on the operation button to select ETC, then press the SET button.
- 3 Press ∇ or Δ to select "TIME CODE", then press the SET button.

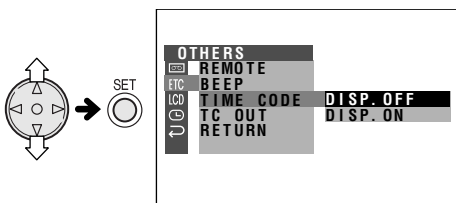

- 4 Press ∇ or Δ to select "DISP. ON", then press the SET button.

TIME CODE DISP. ON

- 5 Press the MENU button to turn off the menu screen.

• The time code appears when the on-screen indicators are turned on.

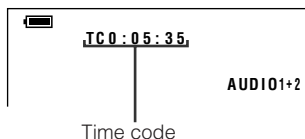

To turn off the time code

Select "DISP. OFF" in step 4 above.

Note:

• When the tape reaches an unrecorded section, the time code returns to zero (TC0:00:00). Once recorded, the time code cannot be changed.

Displaying the time code on a TV during playback

- 1 In VCR mode, press the MENU button until the menu screen appears.
- 2 Press ∇ or Δ on the operation button to select ETC, then press the SET button.
- 3 Press ∇ or Δ to select "TC OUT", then press the SET button.

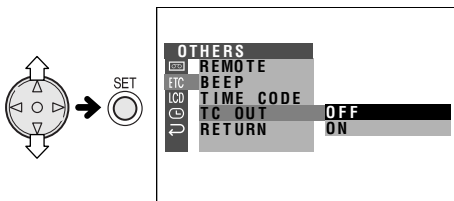

- 4 Press ∇ or Δ to select "ON", then press the SET button.

TC OUT ON

- 5 Press the MENU button to turn off the menu screen.

Editing

Video editing lets you refine your videos by removing unwanted sequences from your tape, or transposing one sequence with another. This camcorder lets you monitor the source program on the built-in LCD monitor without having to connect it to an external TV or video monitor.

Connect the camcorder to a VCR with the supplied audio/video cable, as shown.

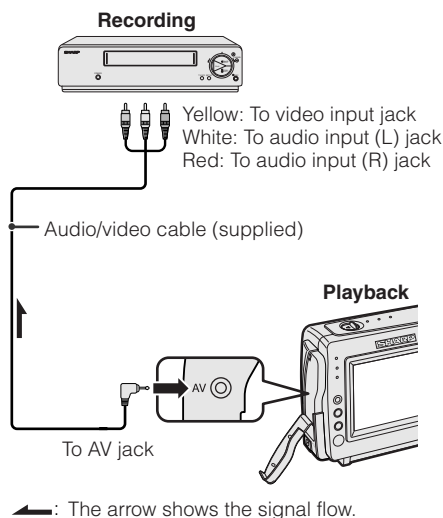

Notes:

- See page 2 for how to open the jack cover.
- If your VCR has only one audio input jack, use the white plug for the audio connection on the VCR.

Cutting Unwanted Sequences

- 1 Play back the tape to be edited on the camcorder, and locate the beginning and end of the sequence you wish to cut. Write down the time code reading at the beginning and end of that sequence (see page 42). Then, rewind the tape to before the beginning of the portion that you wish to keep.
- 2 Load a video cassette into the recording VCR.
- 3 Press Δ on the camcorder to begin playback, then press the Record button on the VCR to begin recording.
- 4 Press the Pause/Still button on the VCR to pause recording when the source tape reaches the beginning of the sequence to be cut.
- 5 Press the Pause/Still (or Record) button on the VCR to resume recording when the source tape reaches the end of the sequence to be cut.

To stop editing

Press ∇ on the camcorder and press the Stop button on the VCR.

Notes:

- Some of the transitions between edited sequences may be slightly off.
- There may be picture noise during video search or still playback. This does not imply a defect in the camcorder.
- The time code display will be recorded along with the edited sequences if the TC OUT menu item is set to "ON". Set to "OFF" before editing (see page 42).

Editing with the DV Terminal (IEEE1394)

This camcorder enables you to perform digital video editing. Connect the camcorder to video equipment with a DV terminal using a commercially available DV cable. A DV cable is able to transfer all dubbing signals including video and audio.

To Record to Video Equipment

See "Cutting Unwanted Sequences" on page 43, using the video equipment as the recording source.

Note:

- Make sure that the video equipment to which you are recording can input dubbing signals via the DV terminal.

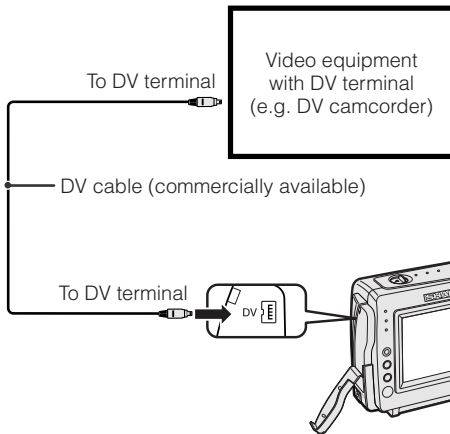

To Record from Video Equipment

- 1 Set the camcorder to VCR mode, and insert a Mini DV cassette.
- 2 Begin playback on the video equipment connected to the camcorder.
 - Check the camcorder screen to see if the picture is properly received.
- 3 Press the REC START/STOP button on the camcorder.
 - The camcorder enters Recording Standby mode.
- 4 Press Δ on the Operation button to begin recording.

To stop recording

Press ∇ on the Operation button.

Cutting Unwanted Sequences

- 1 Press Δ to pause recording when the source tape reaches the beginning of the sequence to be cut.
- 2 Press Δ to resume recording when the source tape reaches the end of the sequence to be cut.

Notes:

- Make sure that the video equipment from which you are recording can output dubbing signals via the DV terminal.
- If the video equipment is not set to playback mode or the DV cable is not properly connected, "NO SIGNAL" is displayed on the camcorder screen.
- If no picture or sound is input to the camcorder even if the DV cable is properly connected and you are playing back the source media from the video equipment, set the Power switch on the camcorder to OFF and then back to VCR, or disconnect the DV cable and connect it again.
- If a digital video recording with a copyright protection signal is used as the playback source, "COPYRIGHT PROTECTED." appears on the camcorder monitor and the recording function is disabled (see page 51).
- When displaying the playback picture on the recording equipment, you may find black bands around the image. This is caused by the differences of the image display sizes.
- You cannot output the picture playing back from the DV terminal to an external monitor.

Audio Dubbing Feature

You can add narration to recordings made with this camcorder, while preserving the original audio and video recordings.

Microphone for Audio Dubbing

You can use the built-in stereo microphone to record narration.

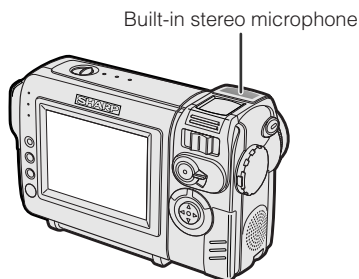

Notes:

- Audio dubbing does not function through the DV terminal.
- You cannot use audio dubbing with recordings made in LP mode.
- You cannot use the built-in stereo microphone for audio dubbing when the audio/video cable is connected.

Audio Recording

In normal recording mode

12-bit audio recording

The audio is recorded in stereo on Audio 1.

Audio 1: Stereo (left and right) sound

Audio 2: No audio

16-bit audio recording

The audio is recorded in stereo with the left and right sound on two separate channels.

Audio 1: Left sound

Audio 2: Right sound

In Audio Dubbing mode

12-bit audio recording

The dubbed audio is recorded on Audio 2.

Audio 1: Original stereo (left and right) sound

Audio 2: Dubbed stereo (left and right) sound

16-bit audio recording

The dubbed audio is recorded on Audio 2 over the original right sound. Both dubbed and original sounds are mono.

Audio 1: Original left sound

Audio 2: Dubbed sound

Note:

- You can select the 12-bit or 16-bit audio recording mode by performing the procedure on page 33.

Audio Dubbing

- 1 Play back the recorded Mini DV cassette and locate the tape position where you wish to start audio dubbing.
- 2 Press Δ to pause playback.
- 3 Press the MENU button until the menu screen appears.
- 4 Press ∇ or Δ on the operation button to select \square , then press the SET button.
- 5 Press ∇ or Δ to select "AUDIO DUB", then press the SET button.
 - The audio dubbing screen appears.

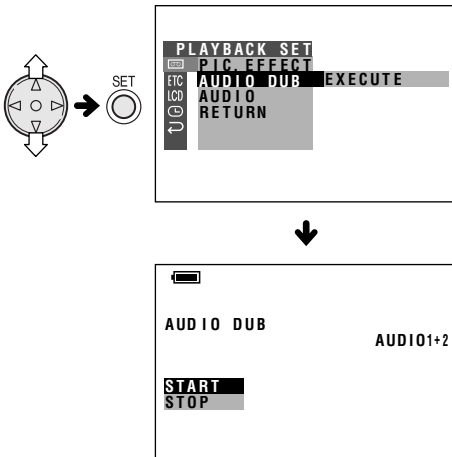

- 6 Press the SET button to begin audio dubbing. Record your narration.

To pause audio dubbing

Press the SET button. To resume audio dubbing, press the SET button again.

To cancel audio dubbing

Press the MENU button. The audio dubbing screen disappears.

If you wish to change the dubbed audio or dub additional scenes

- 1 Press the MENU button to turn off the audio dubbing screen.
- 2 Repeat steps 1 to 6 above.

Notes:

- It is recommended that you use Audio Dubbing only with recordings made with this camcorder. Use of recordings made with other digital video equipment may result in poor audio quality.
- Audio dubbing will automatically pause if the original audio changes from 12-bit mode to 16-bit mode or vice versa. Press the SET button to resume operation.
- Audio dubbing will automatically stop if a portion recorded in LP mode or an unrecorded portion of the tape is encountered.
- You can play back the dubbed audio and the original audio together or separately (see page 47).

Selecting the Audio Playback Mode

You can select any of the following audio playback modes.

Audio 1+2

- 12-bit recording in stereo (Audio 1 and Audio 2 channels)
- 16-bit recording in stereo (left and right channels)

Audio 1

- 12-bit recording in stereo (Audio 1 channel only)
- 16-bit recording in mono (left channel only)

Audio 2

- 12-bit recording in stereo (Audio 2 channel only)
- 16-bit recording in mono (right channel only)

- 1 Play back a Mini DV cassette with dubbed audio.
- 2 Press the MENU button until the menu screen appears.

- 3 Press ∇ or Δ on the operation button to select \square , then press the SET button.
- 4 Press ∇ or Δ to select "AUDIO", then press the SET button.

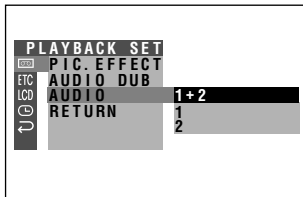
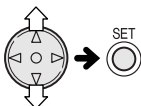

- 5 Press ∇ or Δ to select the desired audio playback mode, then press the SET button.

AUDIO 1+2

- 6 Press the MENU button to turn off the menu screen.
 - The selected audio playback mode indicator only appears when the on-screen indicators are turned on.

Audio playback mode indicator

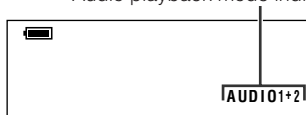

Note:

- The audio playback mode indicator, "AUDIO", displays in different colors depending on the recording mode (12- or 16-bit) used for the recording being played back. A white display indicates 12-bit recording mode, while a green indicates 16-bit.

Picture/Backlight Adjustments

If the picture is difficult to see due to ambient light or other factors, adjust the monitor picture settings.

- The example screens shown are for CAMERA mode.

Adjusting the Picture

- 1 Press the MENU button until the menu screen appears.
- 2 Press ∇ or Δ on the operation button to select LCD, then press the SET button.

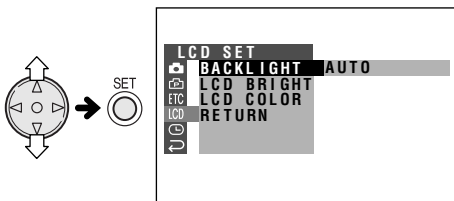

- 3 Press ∇ or Δ to select "LCD BRIGHT" or "LCD COLOR", then press the SET button.
- 4 Press ∇ or Δ to adjust the item to the desired setting.



- 5 Press the SET button, then press the MENU button to turn off the menu screen.

Note:

- When adjusting the color, the picture on the LCD monitor may differ from the picture actually recorded. Do not change the color setting unless necessary. (This adjustment only affects the monitor picture, not the recorded image.)

Adjusting the Backlight

- 1 Press the MENU button until the menu screen appears.
- 2 Press ∇ or Δ on the operation button to select LCD, then press the SET button.
- 3 Press ∇ or Δ to select "BACKLIGHT", then press the SET button.

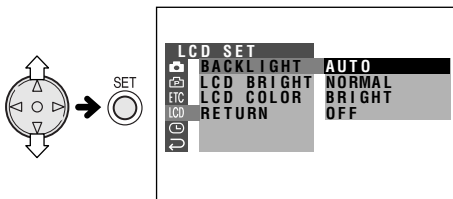

- 4 Press ∇ or Δ to select "AUTO", "NORMAL", "BRIGHT" or "OFF", then press the SET button.

BACK LIGHT BRIGHT

AUTO: The camcorder automatically switches between "NORMAL" and "BRIGHT" depending on the ambient light. This mode is only available in CAMERA mode.

NORMAL: For use indoors or under moderate lighting conditions.

BRIGHT: For use outdoors under strong lighting conditions, such as bright daylight.

OFF: The backlight turns off. To turn it on again, press the MENU button.

- 5 Press the MENU button to turn off the menu screen.

Turning off the Confirmation Sound

A confirmation sound is made when you turn on or off the Power switch, press the REC START/STOP button, or perform other designated operations. Use the procedure below to turn off the confirmation sounds.

- 1 Press the MENU button until the menu screen appears.
- 2 Press ∇ or Δ on the operation button to select ETC, then press the SET button.
- 3 Press ∇ or Δ to select "BEEP", then press the SET button.

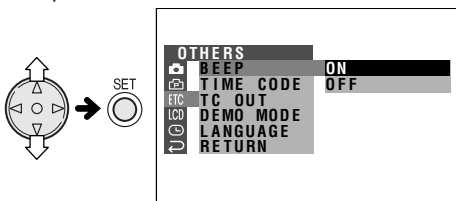

- 4 Press ∇ or Δ to select "OFF", then press the SET button.

BEEP **OFF**

- 5 Press the MENU button to turn off the menu screen.

Useful Information

Hints for Better Shooting

- Position the subject in the center of the scene. When using auto focus, whatever is in the center of the scene is kept in focus.



Position the subject in the center.



Focus manually when you need to position the subject off center (see page 37).

- Avoid backlit subjects. For the best picture, shoot with the light source behind you. When the background is brighter than the subject, the subject often becomes too dark. If you have to record in this lighting, use Gamma Brightness Compensation or correct the exposure level to improve the picture (see pages 25 and 38).

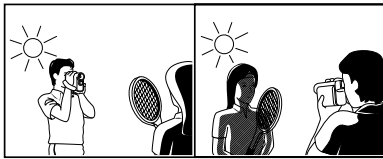

Light from behind

Backlighting

- Before zooming, think about how to best frame the shot. Frequent zooming produces unattractive pictures. It also runs down the battery more quickly.
- When image shaking is noticeable during zoomed-in telephoto shooting, use a tripod or push the Power Zoom control to the W side to zoom out.
- Horizontal panning (lateral movement) and tilting (vertical movement) should be done slowly to emphasize the wide expanse of a scene or the height of a building, and to make scenes easy to watch during playback.
- Use a wide-angle setting for fast-moving subjects.

Note:

- It may take longer to focus when zooming and panning are used frequently.

Lighting

For clear, good-quality recording, 500 to 100,000 lux is needed. Recording is possible with less light, but the picture quality may suffer. Adequate lighting is also essential for correct white balance.

Brightness (Lux)	Situation (Lux)	
100,000	Blue sky Clear day at noon (100,000)	↑ Optimal lighting range ↓
10,000	Clear day at 10 am (65,000) Clear day at 3 pm (35,000) Cloudy day at noon (32,000) Cloudy day at 10 am (25,000)	
1,000	Cloudy day, one hour after sunrise (2,000) Clear day, one hour before sunset (1,000) Fluorescent light near window (1,000)	
100	Factory floor (700–800) Sales counter in department store (500–700) Bowling alley (500) Library (400–500) Office with fluorescent lighting (400–500) Fluorescent desk lamp (400) Flashlight at 3 ft (1 m) (250) Shop stairway (100)	
10	During intermission at movie theater (15–35) Cigarette lighter at 1 ft (30 cm) (15–20) Candles on birthday cake at 8 inches (20 cm) (10–15) Candlelight	

Note:

- The figures in the chart are approximations.

Tips on good lighting

In most outdoor, daytime scenes, natural lighting is adequate for home videos. Indoors, however, artificial lighting is usually required. Video lights with halogen lamps provide the most natural artificial light over a long operating life.

DV Technology

Digital video (DV) is a revolutionary technology that enables recording and playback of high quality images with the use of special digital features previously unavailable with conventional analog formats.

DV and conventional video cassette tapes

There are two kinds of DV-format video cassette tapes: the Mini DV cassette and the larger DV cassette used for extended playback and recording. This camcorder only operates with Mini DV cassettes. DV cassettes cannot be used. Be sure to use Mini DV cassettes with the  mark.

Mini DV cassette



DV cassette

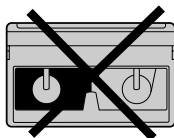

8 mm, VHS, and Beta cassettes cannot be used for playback or recording with this camcorder.

8 mm cassette



VHS cassette

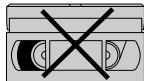

Beta cassette



Note:

- This camcorder reproduces the highest picture quality when used with an ME tape. It is recommended you use an ME tape for high-quality recording and playback.

This product incorporates copyright protection technology that is protected by method claims of certain U.S. patents and other intellectual property rights owned by Macrovision Corporation and other rights owners. Use of this copyright protection technology must be authorized by Macrovision Corporation, and is intended for home and other limited viewing uses only unless otherwise authorized by Macrovision Corporation. Reverse engineering or disassembly is prohibited.

Copyright Protection

The digital VCR has far superior recording and playback ability than the traditional analog VCR, and in order to protect digital video software copyrights, a system for managing copyrights has been established. Some digital video recording with pre-recorded copyright protection signals can still be played back on this camcorder. If you play a digital video recording that has a copyright protection signal on video equipment with a DV terminal and attempt to record a copy of that software on this camcorder, "COPYRIGHT PROTECTED." appears on the screen and the recording is disabled.

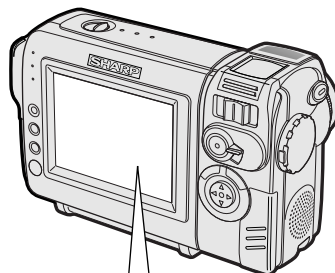

**COPYRIGHT
PROTECTED.**

Mini DV Cassette

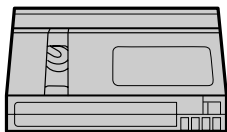

Precautions when using a Mini DV cassette

- Be sure to use only Mini DV cassettes with the **Mini DV** mark.
- This camcorder can record and play back using Mini DV cassettes with cassette memory, but it cannot record or play back this memory.
- To record in LP mode, use a Mini DV cassette labeled for use with LP mode.
- Do not insert anything into the holes on the bottom of the Mini DV cassette or block them in any way.
- Avoid placing the Mini DV cassette in an area conducive to dust or mold.
- Do not place the Mini DV cassette near magnetic sources such as electric clocks or magnetic devices as this may adversely affect recorded material.
- When a previously recorded Mini DV cassette is used again for recording, the previously recorded material will be automatically erased.
- The Mini DV cassette will not operate if inserted in the wrong direction.
- Do not repeatedly insert and eject the Mini DV cassette without running the tape as this may cause uneven tape winding and damage the tape.
- Do not place the Mini DV cassette in direct sunlight, near strong heat sources, or in areas with excessive steam.
- Store the Mini DV cassette in its case and stand it in an upright position.
- If the tape is not properly wound, rewind the tape.
- Do not drop the Mini DV cassette or subject it to excessive shocks.

To protect recordings against accidental erasure

Slide the protect tab on the rear of the Mini DV cassette to the “SAVE” position.



To record over a previously recorded tape, slide the protect tab to the “REC” position.

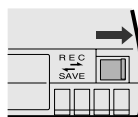

AC Adapter

- The AC adapter may interfere with reception if used near a radio.
- Prevent flammables, liquids, and metal objects from entering the adapter.
- The adapter is a sealed unit. Do not attempt to open or modify it.
- Do not damage, drop, or subject the adapter to vibration.
- Do not leave the adapter in direct sunlight.
- Avoid using the adapter in humid or extremely hot places.

Replacing the Fluorescent Lamp

This camcorder uses a fluorescent lamp to backlight the LCD monitor. If the monitor becomes dark or difficult to view, the fluorescent lamp may need to be replaced. Contact the nearest SHARP service center or your dealer for further advice.

Battery Pack

This camcorder uses a lithium-ion type battery pack.

Charging

- Charge the battery pack immediately (or a day) before use. The battery pack gradually self-discharges even if stored in a fully charged state.
- Charge the battery pack between 50°F and 86°F (10°C and 30°C).
- Fully charge the battery pack. Use of an insufficiently charged battery pack will shorten actual time of use.
- Refresh (discharging before charging) is unnecessary.

Use

- To conserve battery power, be sure to turn off the camcorder power when not in use.
- Battery consumption may vary depending on the condition of use. Recording with many starts and stops, frequent zooming, and recording in low temperatures will shorten actual recording times.
- Use of a weak battery pack may cause loss of power while operating the camcorder. Use a fully charged battery pack to protect both the battery pack and the unit.
- It is recommended that you have enough battery packs on hand to handle two or three times your estimated recording time. See page 16 for the approximate times of actual recording for the battery packs.

Battery power is consumed even when the camcorder power is turned off. If you are not going to use your camcorder immediately, remove the battery pack (see page 7).

Note:

- Use only SHARP BT-L225 or BT-L445 battery packs. These are designed specifically for use with this camcorder.

Storage

- Store the battery pack in a fully discharged state.
- Store the battery pack in a dry, cool place.
- When storing a fully charged battery pack, put the cover on it so that the “CHARGE” mark printed on the label is seen through the window, as shown.

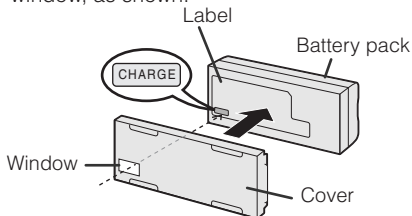

When storing a battery pack that is not fully charged, put the cover upside down so that only the battery pack casing can be seen through the window.

Cautions:

- Improper handling of the battery pack may present a risk of fire or explosion. Pay close attention to the following:
 - Do not allow metallic objects to come in contact with the terminals. This can cause a short circuit.
 - Do not disassemble or repair the battery pack by yourself.
 - Do not use any battery charging equipment other than that designed for use with these battery packs.
 - Do not place the battery pack under direct sunlight or in excessively hot places (over 140°F or 60°C) such as the dashboard of cars.
 - Do not expose the battery pack to moisture or water.
 - Do not drop the battery pack or subject it to strong force.
 - Keep the battery pack out of reach of children.
 - Dispose of used battery packs promptly. Do not dispose of them in fire.
- To protect the terminals, put the cover on the battery pack when it is not in use.

Notes:

- The battery pack will become warm during charging and use. This is not a malfunction.
- The battery pack has a limited service life. If the period of use becomes noticeably shorter with a normal charge, the battery pack is at the end of its service life. Replace it with a new battery pack.
- If the terminals of the battery pack are dirty, wipe the terminals with a soft, dry cloth.

Dew Formation

• What is “dew formation”?

When cold water is poured into a glass, dew drops form on the glass. This clinging of water drops is called dew formation.

• When dew forms in your camcorder.

Dew will gradually form on the head drum of your camcorder and make the video tape stick to the head. This causes damage both to the head and the tape. When dew forms, recording and playback may not function properly.

Dew is likely to form in the following circumstances:

- When moving the camcorder from a cold place to a warm place.
- When placing the camcorder in a cold room which is then heated rapidly.
- When moving the camcorder outdoors from an air conditioned room or car.
- When placing the camcorder in the direct path of air blowing from an air conditioner.
- When placing the camcorder in a humid room.



• How to prevent trouble.

When using the camcorder in a place where dew is likely to form, allow the camcorder and the video tape to acclimate to the surroundings for about one hour.

For example, when bringing the camcorder indoors after skiing, place it in a plastic bag.

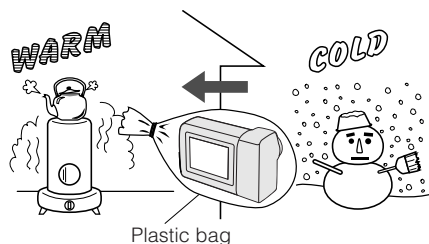

- ① Be sure to tightly seal the plastic bag containing the camcorder.
- ② Remove the bag when the air temperature inside it reaches the temperature of the room.

• “Dew” warning feature

If dew forms, the word “DEW” flashes on the screen, and the power will automatically turn off in approximately 10 seconds.

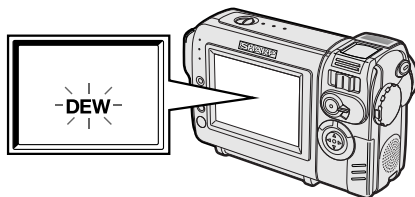

- ① If “DEW” flashes, remove the cassette, leave the cassette compartment open, and wait for a few hours to allow the camcorder to acclimate to the surrounding temperature.
- ② To use the camcorder again, turn on the power after waiting for a few hours. Be sure that “DEW” has disappeared.
- ③ Do not insert a cassette while “DEW” is flashing; this may result in damage to the tape.
- ④ Since dew forms gradually, it may take 10 to 15 minutes before the dew warning feature engages.

Dirty Video Heads

When the video heads have become clogged with dirt (dust and tape coating particles),

Striped noise



Mosaic noise

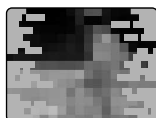

- mosaic-like noise appears on the playback picture. (see above illustration)
- playback pictures do not move.
- during playback, the whole screen becomes blue.

Causes of video head clogging

- High-temperature and high-humidity environment
- A lot of dust in the air
- Damaged tape
- Worn tape
- Long-time use
- Dew formation

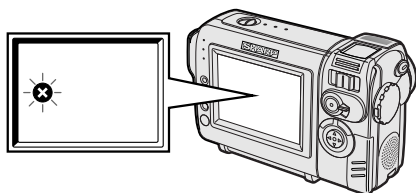

If the video heads become clogged, the  indicator appears on the screen. Contact the nearest SHARP service center or your dealer for further advice.

Using a Cleaning Tape (Commercially Available)

You can clean the video head with a commercially available cleaning tape.

Notes:

- **Excessive use of the cleaning tape may cause damage to the video heads. Please read the instructions accompanying the cleaning tape carefully before using it.**
- The fast forward and rewind functions cannot be used when the cleaning tape is in the camcorder.
- If the video heads again become clogged with dirt soon after cleaning, this might be caused by a damaged tape. In this case, stop using that cassette immediately.

- 1 Insert a cleaning tape into the camcorder.
- 2 Set the camcorder to VCR mode.
 - The video head cleaning screen appears.
- 3 Press the SET button to begin video head cleaning.
 - "NOW CLEANING" flashes during cleaning.



- After about 20 seconds, video head cleaning automatically finishes, and "EJECT THE CASSETTE." displays.

- 4 Remove the cleaning tape.

To cancel cleaning, press the SET button.

Cleaning

- Many plastic parts are used in the camcorder casing. Do not use thinner, benzene or other strong chemical cleaners. These may cause discoloration and damage to the casing.
- Clean the casing with a soft, dry cloth. If the casing is particularly dirty, wipe the casing with a tightly wrung cloth dampened with a diluted, neutral detergent. Then wipe it again with a soft, dry cloth.
- Use a soft cloth to wipe finger marks and other smudges off the LCD screen.
- Use a soft cloth, or compressed air and lens paper designed for photographic lenses to clean the lens.

Using Your Camcorder Abroad

Television signal standards and electrical voltages and frequencies vary substantially from country to country. When you are abroad, check the sections below before using the AC adapter or connecting the camcorder to a TV.

AC Adapter (Supplied Accessory)

The supplied AC adapter is compatible with 50 Hz and 60 Hz electrical systems in the range of 110 V to 240 V AC. Use a commercially available AC plug adaptor, if necessary, depending on the design of the wall outlet.

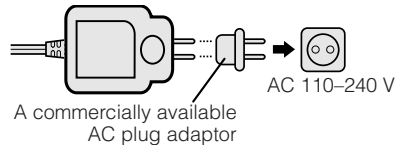

Television Signal Standards

In any country, you can always watch the video picture by using the LCD monitor screen. However, if you want to watch the picture on a TV screen, the TV must be NTSC-M system compatible. NTSC-M is used in the following areas:

The Bahamas, Barbados, Bermuda, Myanmar (previously Burma), Canada, Chile, Colombia, Costa Rica, Cuba, the Dominican Republic, Ecuador, El Salvador, Greenland, Guam, Guatemala, Haiti, Honduras, Jamaica, Japan, South Korea, Mexico, the Netherland Antilles, Nicaragua, Panama, Peru, the Philippines, Puerto Rico, St. Kitts, St. Lucia, Surinam, Taiwan, Trinidad, the U.S.A., Venezuela, Southern Vietnam, and the Virgin Islands.

Demonstration Mode

You can watch a brief demonstration of the special camcorder features in Demo mode. If the demonstration appears on the screen when you turn on the camcorder for the first time, cancel the Demo mode to use your camcorder.

Note:

- The demonstration is only displayed in English.

Watching the Demonstration

- 1 Remove the Mini DV cassette from the camcorder (see page 10).
- 2 In CAMERA mode, press the MENU button until the menu screen appears.
- 3 Press ∇ or Δ on the operation button to select ETC, then press the SET button.
- 4 Press ∇ or Δ to select "DEMO MODE", then press the SET button.

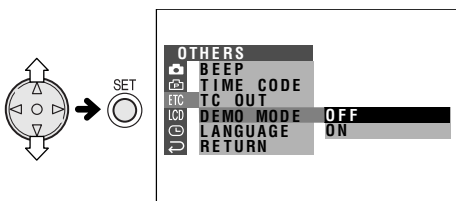

- 5 Press ∇ or Δ to select "ON", then press the SET button.

DEMO MODE ON

- 6 Set the Power switch to OFF, then hold down the Lock button and set the Power switch to CAMERA.
 - The demonstration begins.

Canceling Demo Mode

- 1 During the demonstration, press the MENU button to pause the demonstration.
- 2 Press ∇ or Δ on the operation button to select ETC, then press the SET button.
- 3 Press ∇ or Δ to select "DEMO MODE", then press the SET button.

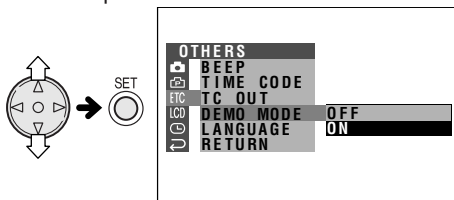

- 4 Press ∇ or Δ to select "OFF", then press the SET button.

DEMO MODE OFF

- 5 Press the MENU button to turn off the menu screen.

Note:

- The demonstration will pause if you press the MENU button. If you leave it for 60 seconds, or turn the power off temporarily and then set the Power switch to CAMERA, the demonstration will begin again.

Before Requesting Service

Before calling for service, please check the following troubleshooting table.

	Symptom	Possible cause	Suggested solution
Power	No power.	Power source is not properly connected.	Connect power source properly (pp. 7, 9).
		Battery pack is not charged.	Charge battery pack sufficiently (p. 8).
		Dew in camcorder.	Wait until dew dries (p. 54).
		Safety function is in effect.	Set Power switch to OFF and remove battery pack. Wait for 2 seconds, then reinstall battery pack and turn on power (p. 7).
CAMERA mode	REC START/STOP button does not work.	Erasure-protect tab on video cassette is open.	Close tab or use a new cassette (p. 52).
	Power suddenly turns off.	Camcorder left in Recording Standby mode for 5 minutes.	Set Power switch to OFF and then back to CAMERA.
	Auto focus does not work.	Manual Focus mode is engaged.	Set to Auto Focus mode (p. 37).
		Zoom used on close subject.	Zoom out from subject (p. 17).
		Subject has little contrast in brightness, or is full of horizontal or vertical stripes.	Focus manually (p. 37).
	Bright subject produces wide vertical lines.	Occurs when shooting subject with strong contrast to the background. Does not indicate a malfunction.	—
	Automatically zooms out without operating Zoom control.	Camcorder is unable to focus when zooming in on subject within 5 feet (1.5 m), and automatically zooms out until it focuses on subject.	—
		No subject in the field of view.	Direct lens to some subject, or set zoom to widest angle before shooting (p. 17).
Display automatically changes in CAMERA mode.	Camcorder is in Demo mode.	Set DEMO MODE menu item to "OFF" (p. 57).	
VCR mode	No image appears on connected TV screen.	Video input channel on TV or TV channel is not selected properly.	Select video input channel or TV channel properly (p. 21).
		Audio/video cable is not properly connected.	Connect audio/video cable properly (p. 21).
	No image from an external source appears on the camcorder screen.	DV cable is not properly connected.	Connect DV cable properly. (p. 44)

	Symptom	Possible cause	Suggested solution
VCR mode	Cannot rewind or fast forward tape.	Position at beginning or end of tape.	Rewind or fast forward tape to desired point (p. 19).
	Video noise in image.	Dirty video heads.	Call for service (p. 60) or use a commercially available cleaning tape (p. 55).
		Old or worn tape.	Use a new cassette.
General	Cassette will not eject.	Power source is not properly connected.	Connect power source properly (pp. 7, 9).
		Battery pack is not charged.	Charge battery pack sufficiently (p. 8).
		Camcorder is recording.	Stop tape and try again (p. 16).
	No image on monitor.	Backlight has been turned off.	Turn on backlight (p. 48).
		Fluorescent lamp has burned out.	Call for service (p. 60).
	Monitor picture is hard to see.	Inappropriate picture adjustments.	Adjust picture (p. 48).
	CHARGE indicator flashes in red when charging battery pack.	AC adapter or battery pack may have malfunctioned.	Call for service (p. 60).
Cannot edit to connected VCR.	Audio/video cable is not properly connected.	Connect audio/video cable properly (p. 43).	

Notes:

- This unit is equipped with a microprocessor. Its performance could be adversely affected by external electrical noise or interference. If this should happen, turn off the power and disconnect the unit from any power sources, including the lithium battery, etc. Then reconnect the power sources to resume operation.
- If the characters displayed on the monitor screen appear to malfunction, disconnect the power source and remove the lithium battery, then reconnect the power source, insert the lithium battery, and turn the power on again. The characters on the monitor should be normal. Set the date and time, then resume operation.

Specifications

Camcorder

Signal System:	NTSC standard
Recording System:	2 rotary heads, helical scanning system
Cassette:	Digital VCR Mini DV video cassette
Recording/Playback Time:	90 minutes (DVM60, LP mode)
Tape Speed:	SP mode: 18.812 mm/second LP mode: 12.555 mm/second
Pickup Device:	1/4" (6.4 mm, effective size: 4.5 mm) CCD image sensor (with approx. 460,000 pixels including optical black)
Lens:	10× optical/300× digital power zoom lens (F1.8, f=3.6–36.0 mm), full-range auto focus
Lens Filter Diameter:	27 mm
Monitor:	3" (7.5 cm) full-color LCD screen (TFT active matrix)
Microphone:	Electret stereo microphone
Color Temperature Compensation:	Auto white balance with white balance lock
Minimum Illumination:	1 lux (12 lux measured by EIA standard) (with gain-up, F1.8)
Power Requirement:	DC 7.4 V
Power Consumption:	4.3 W (during camera recording in Full Auto mode with zoom motor off and backlight in normal mode)
Operating Temperature:	32°F to 104°F (0°C to +40°C)
Operating Humidity:	30% to 80%
Storage Temperature:	–4°F to 140°F (–20°C to +60°C)
Dimensions (approx.):	5 9/16" (W) × 3 11/32" (H) × 2 5/16" (D) [141.1 mm (W) × 85.1 mm (H) × 58.5 mm (D)]
Weight (approx.):	1.01 lbs (460 g) (without battery pack, lithium battery, video cassette, lens cap, lens hood and wrist strap)

AC Adapter (UADP-0339TAZZ)

Power Requirement:	AC 110–240 V, 50/60 Hz
DC Output:	10 V
Dimensions (approx.):	1 31/32" (W) × 1 1/16" (H) × 2 19/32" (D) [50.0 mm (W) × 27.0 mm (H) × 65.5 mm (D)]
Weight (approx.):	0.22 lbs (100 g)

Specifications are subject to change without notice.

SERVICE INFORMATION (For the U.S.)

For the location of the nearest Sharp Authorized Service, or to obtain product literature, accessories, supplies or customer assistance, please call 1-800-BE SHARP (1-800-237-4277) or visit SHARP's website (<http://www.sharp-usa.com>).

Guía de operación rápida en español

Información importante para los consumidores de los EE.UU.

ADVERTENCIA: PARA REDUCIR EL RIESGO DE CAUSAR UN INCENDIO O RECIBIR UNA DESCARGA ELÉCTRICA, NO EXPONGA ESTE APARATO A LA LLUVIA NI A LA HUMEDAD.



PRECAUCION

RIESGO DE SACUDIDA ELÉCTRICA. NO ABRIR.

PRECAUCION:

PARA REDUCIR EL RIESGO DE RECIBIR UNA DESCARGA ELÉCTRICA NO RETIRE LA TAPA. EN EL INTERIOR NO HAY PARTES QUE DEBA REPARAR EL USUARIO. SOLICITE LAS REPARACIONES AL PERSONAL DE SERVICIO CUALIFICADO.

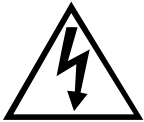

Este símbolo avisa al usuario de la presencia de tensión sin aislar en el interior del aparato que puede causar descargas eléctricas peligrosas.



Este símbolo alerta al usuario de que existen instrucciones de manejo y mantenimiento importantes en la información escrita entregada con este aparato.

PRECAUCION

(se aplica al adaptador de CA suministrado)

PARA IMPEDIR DESCARGAS ELÉCTRICAS, INTRODUZCA LA PATILLA ANCHA EN LA RANURA ANCHA, E INTRODUZCA COMPLETAMENTE LA CLAVIJA.

PRECAUCION

Si el adaptador de CA se extravía o tiene que ser cambiado, adquiera otro del mismo tipo en el centro de servicio SHARP de su concesionario.

PARA TIRAR EL PRODUCTO

Este producto utiliza soldadura de estaño y plomo, y su lámpara fluorescente contiene una pequeña cantidad de mercurio. Debido a la conservación del medio ambiente, puede que para tirar estos materiales deban seguirse ciertos reglamentos. Para obtener información sobre cómo tirar o reciclar estos materiales, póngase en contacto con las autoridades de su localidad o con Electronics Industries Alliance (Alianza de Industrias de la Electrónica) en la dirección de Internet: www.eiae.org.

PARA TIRAR LA BATERÍA

CONTIENE BATERÍA DE IONES DE LITIO. ÉSTA DEBE RECICLARSE O TIRARSE DE LA FORMA APROPIADA. PÓNGASE EN CONTACTO CON LAS AGENCIAS LOCALES PERTINENTES PARA OBTENER INFORMACIÓN SOBRE LOS PLANES DE RECICLADO Y ELIMINACIÓN EXISTENTES EN SU ZONA DE RESIDENCIA.

Precauciones

- **Cuando no utilice la videocámara, no se olvide de extraer el videocasete, desconectar la alimentación y desenchufar la videocámara de la fuente de alimentación.**

- **No dirija el objetivo hacia el sol.**

No permita que la luz del sol directa llegue al objetivo ni a la pantalla del monitor LCD de la videocámara, tanto si está realizando la grabación como si no, porque esto podría dañar el sensor de CCD o la superficie de la pantalla LCD. Tenga mucho cuidado especialmente cuando grabe en exteriores.

- Cuando filme en lugares oscuros, evite filmar repentinamente objetos muy iluminados o fuentes de luz como, por ejemplo, el sol. De lo contrario, la imagen desaparecerá. En tal caso, dirija el objetivo en otra dirección hasta que la imagen recupere la normalidad.

- **Evite los campos magnéticos.**

La utilización de la videocámara cerca de lámparas fluorescentes fuertes, motores, televisores u otros campos magnéticos puede afectar negativamente a las imágenes grabadas.

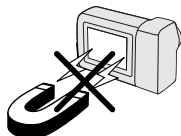

- **La utilización de la videocámara cerca de una emisora u otra fuente potente de transmisión puede causar zumbidos o deterioro en la imagen.**

- **Evite golpearla o dejarla caer.**

No deje caer la videocámara ni tampoco la someta a golpes o vibraciones intensas. Los golpes producidos durante la grabación ocasionarán ruidos en la imagen grabada.

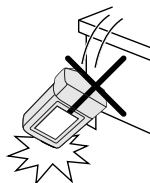

- **Evite poner la videocámara cerca de equipos de iluminación.**

El calor producido por las luces incandescentes puede deformar la videocámara o hacer que ésta funcione mal.

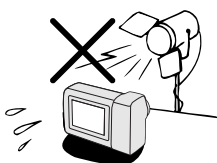

- **Respete siempre las prohibiciones o restricciones relacionadas con la utilización de equipos electrónicos en vuelos comerciales o en otras áreas susceptibles.**

- **Tenga cuidado con la temperatura y la humedad.**

Podrá utilizar su videocámara a temperaturas de entre 32°F y 104°F (0°C y +40°C), con una humedad relativa de entre el 30% y el 80%. Durante el verano, no deje el aparato en el interior de un automóvil sin ventilación; no lo deje tampoco bajo la luz del sol directa ni cerca de fuentes de calor intenso; esto podría estropear considerablemente la caja del aparato y su circuito.



- **Evite situaciones en las que el agua, la arena, el polvo u otras sustancias extrañas puedan entrar en la videocámara, y no utilice ni deje su videocámara en lugares con excesivo humo, vapor o humedad.**

En estos ambientes pueden producirse fallos en el funcionamiento o se puede formar moho en el objetivo.

Asegúrese de guardar este aparato en un lugar bien ventilado.

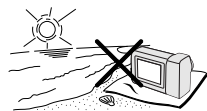

- **Algunos trípodes pequeños y portátiles quizá se acoplen mal a la videocámara, y puede que no sirvan de apoyo seguro. Utilice siempre trípodes fuertes y estables.**

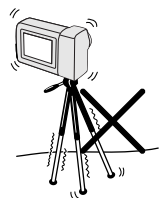

- **Cuando utilice su videocámara en un ambiente frío, la pantalla del monitor LCD aparecerá a menudo menos brillante inmediatamente después de conectar la alimentación. Esto no es ningún fallo de funcionamiento. Para evitar que la videocámara se enfríe excesivamente, envuélvala en un paño grueso (una manta, etc.).**

AVISOS DE SEGURIDAD IMPORTANTES

1. Lectura de las instrucciones—Antes de utilizar este producto deberán leerse todas las instrucciones de seguridad y manejo.
2. Conservación de las instrucciones—Las instrucciones de seguridad y manejo deberán guardarse para poder consultarlas en futuro en caso de ser necesario.
3. Cumplimiento de las advertencias—Deberán cumplirse todas las advertencias del producto y de las instrucciones de manejo.
4. Cumplimiento de las instrucciones—Deberán seguirse todas las instrucciones de manejo.
5. Limpieza—Desenchufe este producto de la toma de corriente de la pared antes de limpiarlo. No utilice agentes de limpieza líquidos ni en aerosol. Utilice un paño húmedo para hacer la limpieza.
6. Aditamentos—No utilice aditamentos que no sean recomendados por el fabricante del producto, porque pueden causar peligros.
7. Agua y humedad—No utilice este producto cerca del agua y la humedad como, —por ejemplo, cerca de una bañera, lavabo, fregadero de cocina o lavadora; no lo utilice tampoco en un sótano húmedo, cerca de una piscina o en otros lugares similares.
8. Accesorios—No coloque este producto sobre un carrito, soporte, trípode, ménsula o mesa inestable. El producto podría caerse y causar lesiones graves a un niño o a un adulto, y también podría estropearse.

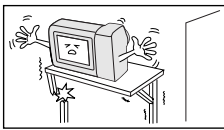

Utilícelo solamente con un carrito, soporte, trípode, ménsula o mesa recomendado por el fabricante, o

vendido con el producto. Cuando quiera que monte el producto hágalo siguiendo las instrucciones del fabricante, y utilizando los accesorios de montaje recomendado por él.

9. La combinación del producto y un carrito deberá moverse con mucho cuidado. Las paradas repentinas, la fuerza excesiva y las superficies irregulares pueden ser la causa de que la combinación del producto y el carrito se vuelquen.
10. Ventilación—Las ranuras y aberturas de la caja sirven para la ventilación del producto, y para asegurar un funcionamiento fiable del mismo y evitar que éste se recaliente,



por lo tanto, éstas no deberán taparse. Las aberturas no deberán taparse nunca colocando el producto en una cama, sofá, alfombra u otras superficies similares. Este producto no deberá colocarse en una instalación empotrada como, por

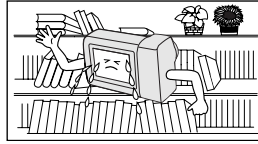

ejemplo, un mueble librería o una estantería, a menos que disponga de la ventilación apropiada o se cumplan las instrucciones del fabricante.

11. Fuentes de alimentación—Este producto sólo deberá ser utilizado con el tipo de fuente de alimentación indicado en la etiqueta de características. Si no está seguro del tipo de alimentación empleado en su casa, consulte a su concesionario o a la compañía eléctrica local. Para los productos que van a ser utilizados con energía de baterías u otras fuentes, consulte las instrucciones de manejo.
12. Puesta a tierra o polarización—Este producto puede estar equipado con una clavija de alimentación de corriente alterna polarizada (una clavija con una patilla más ancha que la otra). Esta clavija sólo entrará en la toma de corriente de una forma, lo que constituye una característica de seguridad. Si no puede introducir a fondo la clavija en la toma de corriente, pruebe invirtiendo la clavija. Si la clavija sigue sin poder introducirse en la toma de corriente, póngase en contacto con un electricista para que le cambie la toma de corriente obsoleta. No anule la característica de seguridad de la clavija polarizada.
13. Protección de cables de alimentación—Los cables de alimentación deberán instalarse de forma que nadie camine sobre ellos ni queden pellizcados por objetos colocados encima o contra ellos, poniendo mucha atención a las clavijas, receptáculos y al punto donde entran y salen del producto.
14. Tormentas eléctricas—Para que este producto disponga de una mayor protección durante una tormenta eléctrica, o para cuando se deje sin atender durante un largo periodo de tiempo, desenchúfelo de la toma de corriente y desconecte la antena o el sistema de cable. Esto impedirá que el producto se estropee debido a las tormentas eléctrica o a la sobretensión en la línea de alimentación.

15. Líneas de alimentación—Una antena exterior no deberá colocarse cerca de líneas de alimentación elevadas ni tampoco cerca de luces eléctricas o circuitos de alimentación, ni donde pueda caer encima de tales líneas de alimentación o circuitos. Cuando instale un sistema de antena exterior deberá tener mucho cuidado para que éste no toque tales líneas de alimentación o circuitos porque el contacto con ellos podría causar un accidente mortal.
16. Sobrecarga—No sobrecargue las tomas de corriente de la pared, los cables de extensión o los receptáculos integrales de otros equipos porque existe el riesgo de que se produzca un incendio o una descarga eléctrica.
17. Entrada de objetos y líquidos—No meta nunca objetos de ningún tipo en este

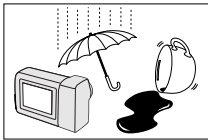

producto a través de las aberturas porque pueden tocar puntos de tensión peligrosos o cortocircuitar partes

que puedan causar un incendio o una descarga eléctrica. No derrame nunca líquidos de ningún tipo en el producto.

18. Servicio—No intente reparar este producto usted mismo ya que al abrirlo o retirar las cubiertas puede exponerse a una tensión peligrosa o a otros peligros. Solicite las reparaciones al personal de servicio cualificado.
19. Daños que requieren ser reparados—Desenchufe este producto de la toma de corriente y solicite las reparaciones al personal de servicio cualificado cuando se produzcan las condiciones siguientes:
 - a. Cuando el cable de alimentación o su clavija estén estropeados.
 - b. Si se ha derramado líquido, o han entrado objetos, en el interior del producto.
 - c. Si el producto ha estado expuesto a la lluvia o al agua.
 - d. Si el producto no funciona normalmente siguiendo las instrucciones de manejo. Ajuste solamente los controles indicados en las instrucciones de manejo, ya que el ajuste incorrecto de otros controles puede causar daños y tal vez se requiera un trabajo de reparación extensivo por parte de un técnico cualificado para devolver el producto a su estado de funcionamiento normal.

- e. Si el producto se ha caído o se ha estropeado de cualquier forma.
- f. Cuando el producto muestre un cambio visible en su rendimiento,—esto indica la necesidad de tener que realizar reparaciones.
20. Partes de recambio—Cuando sea necesario utilizar partes de recambio, asegúrese de que el técnico de servicio emplee aquellas que hayan sido especificadas por el fabricante o que tengan las mismas características que las partes originales. Los cambios no autorizados pueden causar un incendio, descargas eléctricas u otros peligros.
21. Comprobación de seguridad—Al terminar cualquier trabajo de mantenimiento o reparación en este producto, pida al técnico de servicio que realice las comprobaciones de seguridad para determinar si el producto se encuentra en condiciones de funcionamiento apropiadas.
22. Montaje en la pared o en el techo—El producto deberá montarse en una pared o en un techo sólo como lo recomienda su fabricante
23. Calor—El producto deberá instalarse lejos de fuentes de calor tales como radiadores, salidas de calor, estufas y otros aparatos (incluyendo amplificadores) que produzcan calor.

Notas acerca de la utilización de la pila de litio

CAMBIE SÓLO LA PILA POR OTRA DEL TIPO CR2025 FABRICADA POR TOSHIBA, MATSUSHITA O HITACHI MAXELL. LA UTILIZACIÓN DE UNA PILA DIFERENTE PUEDE CAUSAR UN RIESGO DE INCENDIO O EXPLOSIÓN.

ADVERTENCIA MANTENGA ESTA PILA ALEJADA DE LOS NIÑOS. SI ALGUIEN LA TRAGA, CONSULTE INMEDIATAMENTE A UN MÉDICO PARA RECIBIR TRATAMIENTO DE EMERGENCIA.

PRECAUCIÓN LA PILA PUEDE EXPLORAR SI SE UTILIZA MAL O SE INSTALA CON LAS POLARIDADES INVERTIDAS. NO INTENTE CARGARLA, NO LA DESMONTE NI LA TIRE AL FUEGO.

- No cortocircuite, cargue, desmonte o caliente la pila de litio.
- Si la pila de litio tuviera fugas retírela, limpie bien su compartimiento y luego introduzca una pila nueva.
- La pila de litio durará un año aproximadamente si se utiliza bajo condiciones normales.



Guía de operación rápida

Colocación de la batería



- 1 Asegúrese de que el interruptor de alimentación esté en OFF.



- 2 Alinee la marca  del lado de la batería con la marca  de la videocámara (1), y deslice la batería en el sentido de la flecha hasta que quede completamente bloqueada en su lugar (2).

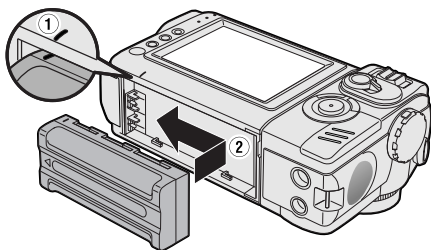

Carga de la batería

- 1 Coloque la batería en la videocámara y asegúrese de que el interruptor de alimentación esté en OFF.
- 2 Enchufe el adaptador de CA en una toma de corriente (1), y luego inserte la clavija de CC en la toma de entrada de CC (2).
 - El indicador de carga se enciende.

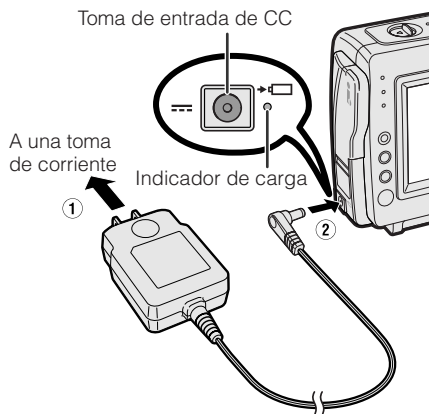

- El indicador de carga se apaga cuando se carga la batería.
- 3 Retire la clavija de CC de la toma de entrada de CC, y luego desconecte el adaptador de CA de la toma de corriente.

Inserción de un casete

- 1 Coloque la fuente de alimentación en la videocámara, y luego deslice el control de apertura de la puerta del compartimento del videocasete y abra la puerta del compartimento del videocasete.

- Después del sonido de confirmación, el portavideocasete se extenderá y abrirá automáticamente.

Control de apertura de la puerta del compartimento del casete

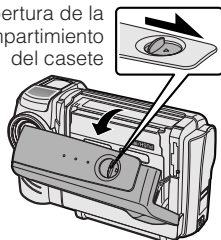

- 2 Inserte completamente un casete de venta en el comercio con la ventanilla hacia fuera, y con la lengüeta de protección contra borrado hacia arriba.

Lengüeta de protección contra borrado

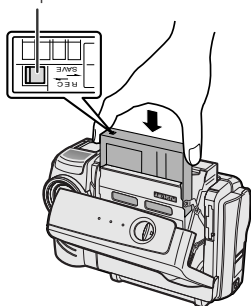

- 3 Pulse suavemente la marca **PUSH/押す** hasta que el portavideocasete encaje en posición produciendo un chasquido.

- Después del sonido de confirmación, el portavideocasete se introducirá automáticamente.

Marca "PUSH/押す"

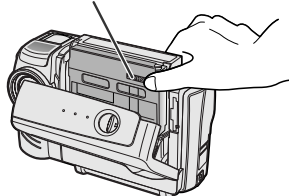

- 4 Espere a que el portavideocasete se pliegue completamente. Cierre la puerta del compartimento presionando sobre el centro hasta que quede cerrada haciendo un ruido seco.

Sugerencias sobre las posiciones de grabación

Para crear imágenes que puedan verse fácilmente durante la reproducción, intente grabarlas estando de pie y sujetando la videocámara firmemente con las manos, para impedir así imágenes que vibren.

Sujeción de la videocámara

Ponga su dedo pulgar derecho cerca del botón REC START/STOP y del control del zoom motorizado.

Ponga su dedo pulgar izquierdo en el apoyo de pulgar situado en el lado izquierdo de la pantalla.

Postura básica



Filmación desde un ángulo alto

Gire el monitor LCD para que la pantalla quede hacia abajo.



Filmación desde un ángulo bajo



Gire el monitor LCD para que la pantalla quede hacia arriba.

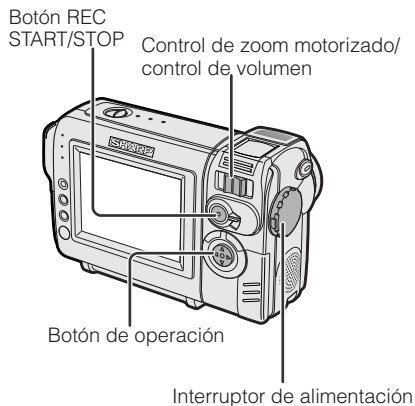

Grabación fácil con la videocámara

- 1 Inserte un casete en la videocámara.
- 2 Mantenga pulsado el botón de bloqueo y ponga el interruptor de alimentación en CAMERA.
 - La imagen captada por el objetivo se visualiza ahora.

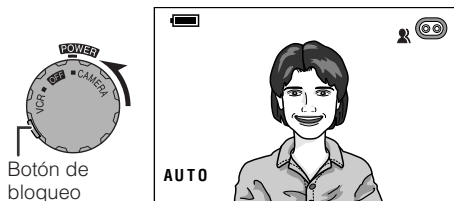

- 3 Pulse el botón REC START/STOP para iniciar la grabación.

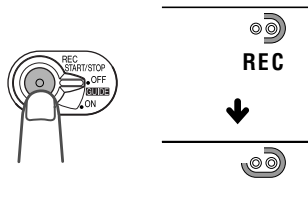

Para hacer una pausa en la grabación

Pulse de nuevo el botón REC START/STOP.

Empleo del zoom

Pulse el control del zoom motorizado hacia el lado de la T (1) (telefoto) o el lado de la W (2) (granangular).

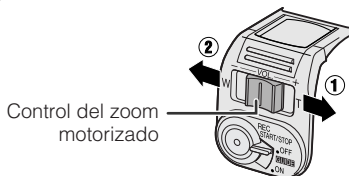

Reproducción

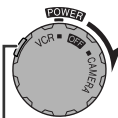
- 1 Mantenga pulsado el botón de bloqueo y ponga el interruptor de alimentación en VCR.
 

Botón de bloqueo
- 2 Pulse ◀ (o ▶) del botón de operación para rebobinar (o avanzar rápidamente) la cinta hasta el punto deseado.

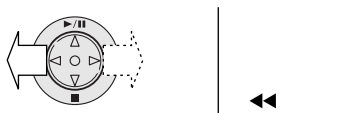

- 3 Pulse ▲ para iniciar la reproducción.



Para detener la reproducción

Pulse ▼.

Control de volumen

Pulse el control de volumen hacia el lado + o - para aumentar (1) o disminuir (2) el volumen.

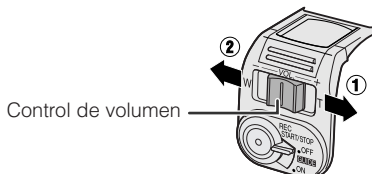

Visualizaciones en pantalla en español

Cuando se selecciona "ESPAÑOL" como idioma de la visualización en pantalla aparecen las siguientes visualizaciones indicadas a continuación.

Modo CAMERA

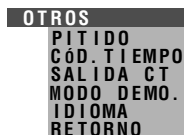
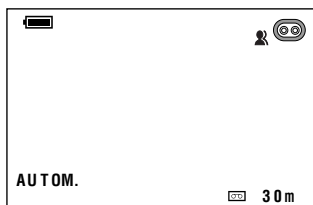

Modo VCR

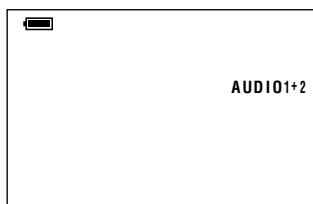

Affichages sur écran en français

Les affichages sur écran suivants apparaissent lorsque "FRANÇAIS" est sélectionné pour la langue de l'affichage.

Mode CAMERA

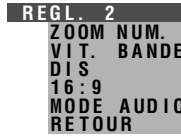
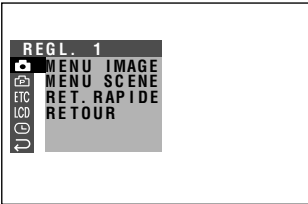
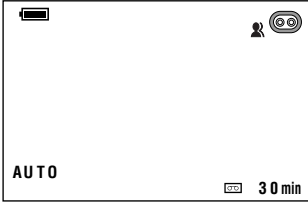

Mode VCR

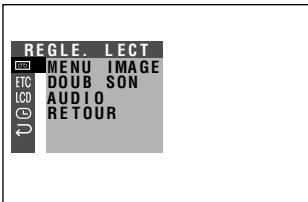
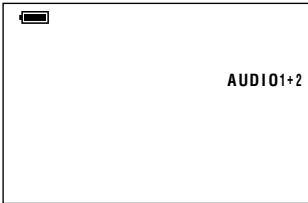

Note

CONSUMER LIMITED WARRANTY

SHARP ELECTRONICS CORPORATION warrants to the first consumer purchaser that this Sharp brand product (the "Product"), when shipped in its original container, will be free from defective workmanship and materials, and agrees that it will, at its option, either repair the defect or replace the defective Product or part thereof with a new or remanufactured equivalent at no charge to the purchaser for parts or labor for the period(s) set forth below.

This warranty does not apply to any appearance items of the Product nor to the additional excluded item(s) set forth below nor to any Product the exterior of which has been damaged or defaced, which has been subjected to improper voltage or other misuse, abnormal service or handling, or which has been altered or modified in design or construction.

In order to enforce the rights under this limited warranty, the purchaser should follow the steps set forth below and provide proof of purchase to the servicer.

The limited warranty described herein is in addition to whatever implied warranties may be granted to purchasers by law. ALL IMPLIED WARRANTIES INCLUDING THE WARRANTIES OF MERCHANTABILITY AND FITNESS FOR USE ARE LIMITED TO THE PERIOD(S) FROM THE DATE OF PURCHASE SET FORTH BELOW. Some states do not allow limitations on how long an implied warranty lasts, so the above limitation may not apply to you.

Neither the sales personnel of the seller nor any other person is authorized to make any warranties other than those described herein, or to extend the duration of any warranties beyond the time period described herein on behalf of Sharp.

The warranties described herein shall be the sole and exclusive warranties granted by Sharp and shall be the sole and exclusive remedy available to the purchaser. Correction of defects, in the manner and for the period of time described herein, shall constitute complete fulfillment of all liabilities and responsibilities of Sharp to the purchaser with respect to the Product, and shall constitute full satisfaction of all claims, whether based on contract, negligence, strict liability or otherwise. In no event shall Sharp be liable, or in any way responsible, for any damages or defects in the Product which were caused by repairs or attempted repairs performed by anyone other than an authorized servicer. Nor shall Sharp be liable or in any way responsible for any incidental or consequential economic or property damage. Some states do not allow the exclusion of incidental or consequential damages, so the above exclusion may not apply to you.

THIS WARRANTY GIVES YOU SPECIFIC LEGAL RIGHTS. YOU MAY ALSO HAVE OTHER RIGHTS WHICH VARY FROM STATE TO STATE.

Model Specific Section**Your Product Model
Number & Description:**

VL-NZ50U Camcorder
(Be sure to have this information available when you need service for your Product.)

Warranty Period for this Product:

One (1) year parts and ninety (90) days labor from date of purchase except for the rechargeable battery incorporated in this Product which is warranted for thirty (30) days from date of purchase.

**Additional Item(s) Excluded
from Warranty Coverage (if any):**

Non-rechargeable batteries.

Where to Obtain Service:

From a Sharp Authorized Servicer located in the United States. To find the location of the nearest Sharp Authorized Servicer, call Sharp toll free at 1-800-BE-SHARP.

What to do to Obtain Service:

Ship prepaid or carry in your Product to a Sharp Authorized Servicer. Be sure to have **Proof of Purchase** available. If you ship the Product, be sure it is insured and packaged securely.

TO OBTAIN SUPPLY, ACCESSORY, OR PRODUCT INFORMATION, GO TO OUR WEBSITE AT www.sharp-usa.com
OR CALL 1-800-BE-SHARP

SHARP®**SHARP ELECTRONICS CORPORATION**

Sharp Plaza, Mahwah, New Jersey 07430-2135

SHARP CORPORATION

Osaka, Japan

Printed in Japan
TINSE0443TAZZ®
02P01-JKG