



SHARP®

XV-Z10000

PROJECTOR
PROJECTEUR
PROYECTOR
PROJETOR

OPERATION MANUAL
MODE D'EMPLOI
MANUAL DE OPERACION
MANUAL DE OPERAÇÃO

XV-Z10000

SHARP®

SHARP CORPORATION

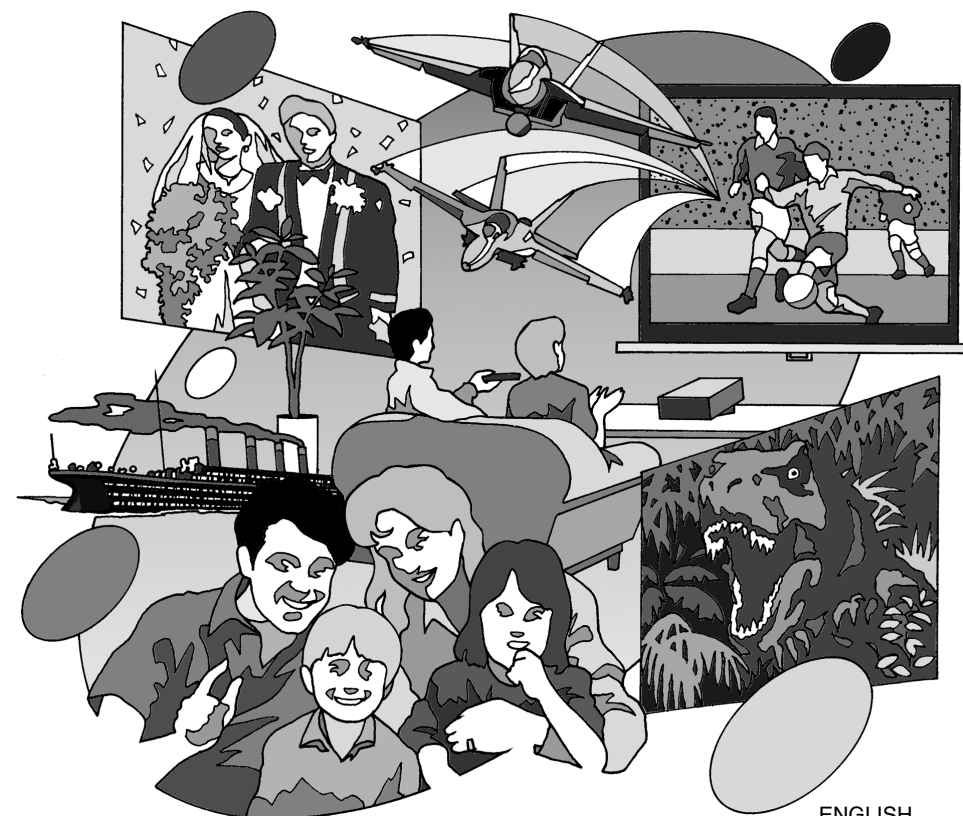

ENGLISH (E) -1 - (E) -XX
FRANÇAIS (F) -1 - (F) -XX
ESPAÑOL (ES) -1 - (ES) -XX
PORTUGUÊS (P) -1 - (P) -XX

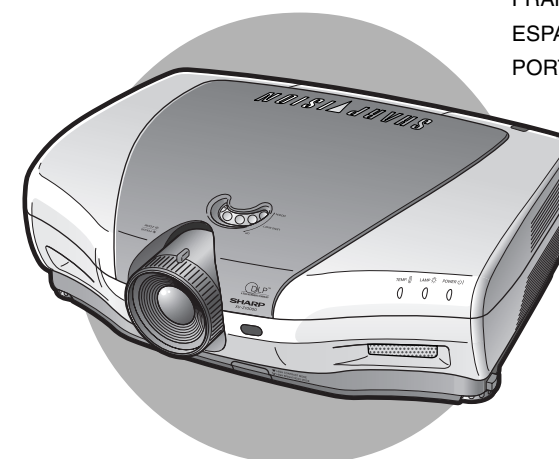

Printed in Japan
Imprimé au Japon
Impreso en Japón
Impresso no Japão
TINS-A440WJZZ
02PXX-JWM

SHARP®



02.10.25, 7:21 PM





Before using the projector, please read this operation manual carefully.

Introduction ENGLISH

IMPORTANT

For your assistance in reporting the loss or theft of your Projector, please record the Serial Number located on the bottom of the projector and retain this information. Before recycling the packaging, please be sure that you have checked the contents of the carton thoroughly against the list of "Supplied accessories" on page 14.

Model No.: XV-Z10000

Serial No.:

There are two important reasons for prompt warranty registration of your new SHARP Projector, using the REGISTRATION CARD packed with the projector.

1. WARRANTY

This is to assure that you immediately receive the full benefit of the parts, service and labor warranty applicable to your purchase.

2. CONSUMER PRODUCT SAFETY ACT

To ensure that you will promptly receive any safety notification of inspection, modification, or recall that SHARP may be required to give under the 1972 Consumer Product Safety Act, PLEASE READ CAREFULLY THE IMPORTANT "LIMITED WARRANTY" CLAUSE.

U.S.A. ONLY

WARNING: High brightness light source. Do not stare into the beam of light, or view directly. Be especially careful that children do not stare directly into the beam of light.

WARNING: To reduce the risk of fire or electric shock, do not expose this product to rain or moisture.

See bottom of actual set.

CAUTION

**RISK OF ELECTRIC SHOCK.
DO NOT REMOVE SCREWS
EXCEPT SPECIFIED USER
SERVICE SCREWS.**

The lightning flash with arrowhead symbol, within an equilateral triangle, is intended to alert the user to the presence of uninsulated "dangerous voltage" within the product's enclosure that may be of sufficient magnitude to constitute a risk or electric shock to persons.

**CAUTION: TO REDUCE THE RISK OF ELECTRIC SHOCK,
DO NOT REMOVE COVER.
NO USER-SERVICEABLE PARTS EXCEPT LAMP UNIT.
REFER SERVICING TO QUALIFIED SERVICE
PERSONNEL.**

The exclamation point within a triangle is intended to alert the user to the presence of important operating and maintenance (servicing) instructions in the literature accompanying the product.

WARNING: FCC Regulations state that any unauthorized changes or modifications to this equipment not expressly approved by the manufacturer could void the user's authority to operate this equipment.

U.S.A. ONLY



INFORMATION

This equipment has been tested and found to comply with the limits for a Class B digital device, pursuant to Part 15 of the FCC Rules. These limits are designed to provide reasonable protection against harmful interference in a residential installation. This equipment generates, uses, and can radiate radio frequency energy and, if not installed and used in accordance with the operation manual, may cause harmful interference to radio communications. However, there is no guarantee that interference will not occur in a particular installation. If this equipment does cause harmful interference to radio or television reception, which can be determined by turning the equipment off and on, the user is encouraged to try to correct the interference by one or more of the following measures:

- Reorient or relocate the receiving antenna.
- Increase the separation between the equipment and the receiver.
- Connect the equipment into an outlet on a circuit different from that to which the receiver is connected.
- Consult the dealer or an experienced radio/TV technician for help.

U.S.A. ONLY

Declaration of Conformity

SHARP PROJECTOR, MODEL XV-Z10000

This device complies with Part 15 of the FCC rules. Operation is subject to the following conditions: (1) This device may not cause harmful interference, and (2) this device must accept any interference received, including interference that may cause undesired operation.

Responsible Party:

SHARP ELECTRONICS CORPORATION
Sharp Plaza, Mahwah, New Jersey 07430
TEL: 1-800-BE-SHARP (1-800-237-4277)

U.S.A. ONLY

WARNING:

The cooling fan in this projector continues to run for about 90 seconds after the projector is turned off. During normal operation, when turning the power off always use the power (**OFF**) button on the projector or on the remote control. Ensure the cooling fan has stopped before disconnecting the power cord.
DURING NORMAL OPERATION, NEVER TURN THE PROJECTOR OFF BY DISCONNECTING THE POWER CORD. FAILURE TO OBSERVE THIS WILL RESULT IN PREMATURE LAMP FAILURE.

PRODUCT DISPOSAL

This projector utilizes tin-lead solder, high intensity discharge lamp (HID lamp) containing a small amount of mercury. Disposal of these materials may be regulated due to environmental considerations. For disposal or recycling information, please contact your local authorities or, if you are located in the United States of America, the Electronic Industries Alliance: www.eiae.org.

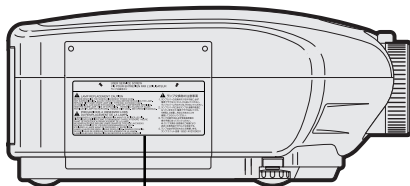

Caution Concerning the Lamp Replacement

See "Replacing the Lamp" on page 76.

USER SERVICE SCREW VIS POUR ENTRETIEN PAR L'UTILISATEUR ランプ交換用ネジ	
<p>⚠ LAMP REPLACEMENT CAUTION BEFORE REMOVING THE SCREW, DISCONNECT POWER CORD. HOT SURFACE INSIDE. ALLOW 1 HOUR TO COOL BEFORE REPLACING THE LAMP. REPLACE WITH SAME SHARP LAMP UNIT TYPE BQC-XVZ100001 ONLY. UV RADIATION: CAN CAUSE EYE DAMAGE. TURN OFF LAMP BEFORE SERVICING. HIGH PRESSURE LAMP: RISK OF EXPLOSION. POTENTIAL HAZARD OF GLASS PARTICLES IF LAMP HAS RUPTURED, HANDLE WITH CARE. SEE OPERATION MANUAL.</p>	<p>⚠ ランプ交換時の注意事項 1. ランプカバーの交換用ネジを外す前に、必ず電源プラグをコンセントから抜いてください。ランプカバー以外の部分は、外さないでください。 2. ランプカバー内にあるランプは、過電圧高圧になっていしますので、電源プラグを抜いてから1時間以上放置し、完全に冷めたことを確認してから行ってください。 3. ランプ交換方法は、必ず取扱説明書の操作手順に従って行ってください。 ※、ランプ交換は、お客様のご希望によりお近くの販売店で行うことも可能です。 4. ランプは必ず所定のものに交換いたします。ランプユニット番号: BQC-XVZ100001</p>
<p>⚠ PRECAUTIONS A OBSERVER LORS DU REMPLACEMENT DE LA LAMPE. DEBRANCHER LE CORDON D'ALIMENTATION AVANT DE RETIRER LES VIS. L'INTERIEUR DU BOITIER ETANT EXTREMEMENT CHAUD, ATTENDRE 1 HEURE AVANT DE PROCEDER AU REMPLACEMENT DE LA LAMPE. NE REMPLACER QUE PAR UNE LAMPE SHARP DE TYPE BQC-XVZ100001. RAYONS ULTRAVIOLETS: PEUVENT ENDOMMAGER LES YEUX. ETENDRE LA LAMPE AVANT DE PROCEDER A L'ENTRETIEN. LAMPE A HAUTE PRESSION: RISQUE D'EXPLOSION. DANGER POTENTIEL DE PARTICULES DE VERRE EN CAS D'ECLATEMENT DE LA LAMPE. A MANIPULER AVEC PRECAUTION. SE REPORTER AU MODE D'EMPLOI.</p>	

WARNING:

Some IC chips in this product include confidential and/or trade secret property belonging to Texas Instruments. Therefore you may not copy, modify, adapt, translate, distribute, reverse engineer, reverse assemble or discompile the contents thereof.





Outstanding Features

1. High Color Purity and Broad Dynamic Range Due to Advanced Optical Engine

- Newly developed 12° DMD™ chip provides significantly improved optical efficiency and excellent contrast ratio.
- Newly developed DDR (Double Data Rate) chip eliminates Color Breaking phenomena common with previous generation DLP™ projectors.
- Superior image quality with Minolta™ optical lens system.
- Use of 270 W high-output lamp realizes both high color purity and high brightness. Natural images made possible by high color reproducibility can be created with high-brightness, powerful expression capabilities.

2. Advanced Computer & Video Integrated Composer Technology

- Realizes vivid images using the latest image quality circuitry.
 - New I/P conversion algorithm enhances the performance of the motion detect I/P conversion.

Extensive improvements on the jagged edges or slanted lines in moving images.

- **New Edge Up-Scaling**

As a result of reducing jaggies and flickering when up-scaling edges of slanted lines, even signals not reaching a panel resolution of 480I/P can be projected by converting to 720P high-definition images.

- **New Film Mode Function**

Three-two pull down enhancement for not only 480I and 576I signals, but HDTV 1080I signals as well.

- **Noise Reduction**

Allows for a clear image even with noisy source signals.

- **Contrast Control Dynamic Gamma**

Improved contrast and natural color gradation by minimizing hue change.

- **Color Management System**

Color Management System that freely adjusts only specific hues of RGBCMY enables easy adjustment of only specific locations of an image without affecting other portions of the image.

- **Gamma Adjustment Function**

Gamma Adjustment Function adds adjustments to each RGB gamma curve for finer image adjustment.

3. Low Noise Design

A new optical engine has been developed for this product resulting in minimized fan noise for undisturbed viewing.

4. All Digital Projection

Use of a DVI/HDCP terminal enables all processes from input to signal processing and projection to be performed digitally, resulting in the realization of all-digital projection without any data loss due to analog conversion. This also supports the building of home theaters using HTPC*.

* Abbreviation for Home Theater Personal Computer that enables high-definition DVD playback using a personal computer.



Contents

Introduction	1
Outstanding Features	3
Important Safeguards	8
Be sure to read the following safeguards when setting up your projector.	8
How to Access the PDF Operation Manuals of SharpVision Manager	9
Part Names	10
Projector (Front and Top View)	10
Projector (Rear View)	11
Part Names	12
Remote Control (Front View)	12
Remote Control (Top View)	12
Using the Remote Control	13
Available Range of the Remote Control	13
Inserting the Batteries	13
Accessories	14
Connections and Setup	
Connecting the Projector to Other Devices	16
Before Connecting	16
This projector can be connected to:	16
Connecting the Power Cord	16
Connecting to Video Equipment	17
Connecting to Video Equipment Using an S-video or a Composite Video Cable	17
Connecting to Component Video Equipment Using a Component Cable (INPUT 1 or 2)	18
Connecting to RGB Video Equipment Using a 5RCA RGB Cable (INPUT 1 or 2)	18
Connecting to Component Video Equipment Using a 3 RCA to 15-pin D-Sub Cable Using the DVI to 15-pin D-Sub adaptor (INPUT 5)	19
Connecting to Video Equipment with the DVI Output Terminal Using the DVI Cable	20
Connecting the Projector to a Computer	21
Connecting to a Computer Using the the DVI to 15-pin D-sub Adaptor and the RGB Cable	21
Connecting to a Computer Using a DVI Cable (Sold Separately)	22
Connecting the thumbscrew cables	22
“Plug and Play” function	22
Controlling the Projector by a Computer	23
Controlling the Projector Using an RS-232C Cable ...	23
Using as a Wired Remote Control	24
Connecting the Remote Control to the Projector	24
Using the Adjustment Feet	25
Adjusting the Lens	26
Using the Lens Shift	27
Selecting the HIGH CONTRAST/ HIGH BRIGHTNESS MODE	27
Setting up the Screen	28
Example of Standard Setup	28
Screen Size and Projection Distance	29
Projecting a Reversed/Inverted Image	30

E-4

Basic Operation

Image Projection	32
Basic Procedure	32
Selecting the On-screen Display Language	34
Keystone Correction and Vertical Size Adjustment	36
Correcting Trapezoidal Distortion and Adjusting the Vertical Size of the Picture	36
Menu Bar Items	38
Using the Menu Screen	40
Menu Selections (Adjustments)	40
Menu Selections (Settings)	42
Adjusting the Picture	44
Adjusting Image Preferences	44
Emphasizing the Contrast	45
Selecting the Gamma Position	45
Selecting the C.M.S. Color	45
Progressive Mode	46
Picture Setting Function	47
Adjusting the Gamma	48
Selecting the Gamma Position	48
Adjusting the Gamma	49
Color Management System (C. M. S.)	50
Selecting the Color Reproduction Mode	50
Selecting the Target Color	50
Setting the Brightness of the Target Color	51
Setting the Chromatic Value of the Target Color	51
Setting the Hue of the Target Color	51
Resetting User-Defined Color Settings	52
Overview of All Color Settings	52
Adjusting Computer Images	53
When Auto Sync is OFF	53
Saving Adjustment Settings	53
Selecting Adjustment Settings	54
Special Mode Settings	54
Checking the Input Signal	55
Auto Sync Adjustment	55
Auto Sync Display Function	56

Easy to Use Functions

Selecting the Picture Display Mode	58
Switching the Picture Display Using Different Input Signals	58
Switchable High Contrast/ High Brightness Mode	61
Operating the Theater Mode Function	61
Digital Shift Function	62
Adjusting the Digital Shift	62
Subtitle Setting	62
Adjusting the Vertical Size of the Display	62
Video Digital Noise Reduction (DNR) System	63
Reducing Image Noise	63



Setting On-screen Display 63
 Turning Off the On-screen Display 63
 Selecting the Signal Type 64
Setting the Video System 65
 Setting the Video System 65
Setting a Background Image 66
 Selecting a Background Image 66
Selecting the Economy Mode 67
 Setting the Power Save 67
 RS-232C Off Function 67
 Automatic Power Off Function 68
Selecting the Transmission Speed (RS-232C) ... 68
 Selecting the Transmission Speed (RS-232C) 68
Reversing/Inverting Projected Images 69
 Setting the Projection Mode 69
Displaying the Adjustment Settings 70
 Overview of All Menu Settings 70

Appendix

Maintenance 72
Cleaning the Ventilative Holes 73
 Cleaning the Ventilative Holes 73
Maintenance Indicators 74

Regarding the Lamp 76
 Lamp 76
 Caution Concerning the Lamp 76
 Replacing the Lamp 76
 Removing and Installing the Lamp Unit 77
 Resetting the Lamp Timer 78
Connecting Pin Assignments 79
(RS-232C) Specifications and
Command Settings 80
 PC control 80
 Communication conditions 80
 Basic format 80
 Commands 80
Wired Remote Control Terminal
Specifications 83
 Specifications of wired remote control input 83
 Function and transmission codes 83
 Sharp remote control signal format 83
Computer Compatibility Chart 84
Troubleshooting 85
For SHARP Assistance (U.S.A only) 86
Specifications 87
Dimensions 88
Glossary 89
Index 90



IMPORTANT SAFEGUARDS

CAUTION: Please read all of these instructions before you operate this product and save them for later use.

Electrical energy can perform many useful functions. This product has been engineered and manufactured to assure your personal safety. BUT IMPROPER USE CAN RESULT IN POTENTIAL ELECTRICAL SHOCK OR FIRE HAZARDS. In order not to defeat the safeguards incorporated in this product, observe the following basic rules for its installation, use and servicing.

1. Read Instructions

All the safety and operating instructions should be read before the product is operated.

2. Retain Instructions

The safety and operating instructions should be retained for future reference.

3. Heed Warnings

All warnings on the product and in the operating instructions should be adhered to.

4. Follow Instructions

All operating and use instructions should be followed.

5. Cleaning

Unplug this product from the wall outlet before cleaning. Do not use liquid cleaners or aerosol cleaners. Use a damp cloth for cleaning.

6. Attachments

Do not use attachments not recommended by the product manufacturer as they may cause hazards.

7. Water and Moisture

Do not use this product near water—for example, near a bath tub, wash bowl, kitchen sink, or laundry tub; in a wet basement; or near a swimming pool; and the like.

8. Accessories

Do not place this product on an unstable cart, stand, tripod, bracket, or table. The product may fall, causing serious injury to a child or adult, and serious damage to the product. Use only with a cart, stand, tripod, bracket, or table recommended by the manufacturer, or sold with the product. Any mounting of the product should follow the manufacturer's instructions, and should use a mounting accessory recommended by the manufacturer.

9. Transportation

A product and cart combination should be moved with care. Quick stops, excessive force, and uneven surfaces may cause the product and cart combination to overturn.



10. Ventilation

Slots and openings in the cabinet are provided for ventilation to ensure reliable operation of the product and to protect it from overheating, and these openings must not be blocked or covered. The openings should never be blocked by placing the product on a bed, sofa, rug, or other similar surface. This product should not be placed in a built-in installation such as a bookcase or rack unless proper ventilation is provided or the manufacturer's instructions have been adhered to.

11. Power Sources

This product should be operated only from the type of power source indicated on the marking label. If you are not sure of the type of power supply to your home, consult your product dealer or local power company. For products intended to operate from battery power, or other sources, refer to the operating instructions.

12. Grounding or Polarization

This product is equipped with a three-wire grounding-type plug, a plug having a third (grounding) pin. This plug will only fit into a grounding-type power outlet. This is a safety feature. If you are unable to insert the plug into the outlet, contact your electrician to replace your obsolete outlet. Do not defeat the safety purpose of the grounding-type plug.

13. Power-Cord Protection

Power-supply cords should be routed so that they are not likely to be walked on or pinched by items placed upon or against them, paying particular attention to cords at plugs, convenience receptacles, and the point where they exit from the product.

14. Lightning

For added protection for this product during a lightning storm, or when it is left unattended and unused for long periods of time, unplug it from the wall outlet and disconnect the cable system. This will prevent damage to the product due to lightning and power-line surges.

15. Overloading

Do not overload wall outlets, extension cords, or integral convenience receptacles as this can result in a risk of fire or electric shock.

16. Object and Liquid Entry

Never push objects of any kind into this product through openings as they may touch dangerous voltage points or short-out parts that could result in a fire or electric shock. Never spill liquid of any kind on the product.

17. Servicing

Do not attempt to service this product yourself as opening or removing covers may expose you to dangerous voltage or other hazards. Refer all servicing to qualified service personnel.



18. Damage Requiring Service

Unplug this product from the wall outlet and refer servicing to qualified service personnel under the following conditions:

- a. When the power-supply cord or plug is damaged.
- b. If liquid has been spilled, or objects have fallen into the product.
- c. If the product has been exposed to rain or water.
- d. If the product does not operate normally by following the operating instructions. Adjust only those controls that are covered by the operating instructions, as an improper adjustment of other controls may result in damage and will often require extensive work by a qualified technician to restore the product to normal operation.
- e. If the product has been dropped or damaged in any way.
- f. When the product exhibits a distinct change in performance.

19. Replacement Parts

When replacement parts are required, be sure the service technician has used replacement parts specified by the manufacturer or have the same characteristics as the original part. Unauthorized substitutions may result in fire, electric shock, or other hazards.

20. Safety Check

Upon completion of any service or repairs to this product, ask the service technician to perform safety checks to determine that the product is in proper operating condition.

21. Wall or Ceiling Mounting

This product should be mounted to a wall or ceiling only as recommended by the manufacturer.

22. Heat

This product should be situated away from heat sources such as radiators, heat registers, stoves, or other products (including amplifiers) that produce heat.

**INTELLECTUAL PROPERTY RIGHTS
IMPORTANT
READ BEFORE USING THE PRODUCT**

- Digital Light Processing, DLP, Digital Micromirror Device and DMD are trademarks of Texas Instruments.
- Microsoft and Windows are registered trademarks of Microsoft Corporation in the United States and/or other countries.
- PC/AT is a registered trademark of International Business Machines Corporation in the United States.
- Adobe Acrobat is a trademark of Adobe Systems Incorporated.
- Macintosh is a registered trademark of Apple Computer, Inc. in the United States and/or other countries.
- Minolta is a registered trademark of Minolta Co., Ltd.
- All other company or product names are trademarks or registered trademarks of their respective companies.



IMPORTANT SAFEGUARDS

Be sure to read the following safeguards when setting up your projector.

Caution concerning the lamp unit

- Potential hazard of glass particles if lamp ruptures. In case of lamp rupture, contact your nearest Authorized SharpVision Service Center or Dealer for replacement.

See "Replacing the Lamp" on page 76.

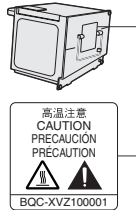

Cautions concerning the setup of the projector

- For minimal servicing and to maintain high image quality, SHARP recommends that this projector be installed in an area free from humidity, dust and cigarette smoke. When the projector is subjected to these environments, the lens must be cleaned more often. As long as the projector is regularly cleaned, use in these environments will not reduce the overall operation life of the unit. Internal cleaning should only be performed by an Authorized SharpVision Service Center or Dealer.

Do not set up the projector in places exposed to direct sunlight or bright light.

- Position the screen so that it is not in direct sunlight or room light. Light falling directly on the screen washes out the colors, making viewing difficult. Close the curtains and dim the lights when setting up the screen in a sunny or bright room.

The projector may safely be tilted to a maximum angle of 5 degrees.

- Placement should be within ± 5 degrees.

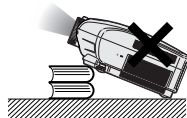

Do not subject the projector to hard impact and/or vibration.

- Take care with the lens so as not to hit or damage the surface of the lens.

Rest your eyes occasionally.

- Watching the screen for long hours continuously will make your eyes tired. Be sure to occasionally rest your eyes.

Avoid locations with high or low temperature.

- The operating temperature for the projector is from 41°F to 95°F (+5°C to +35°C).
- The storage temperature for the projector is from -4°F to 140°F (-20°C to +60°C).

Do not block the intake and exhaust vents.

- Allow at least 1 foot (30 cm) of space between the exhaust vent and the nearest wall or obstruction.

- Be sure that the intake vent and the exhaust vent are not obstructed.
- If the cooling fan becomes obstructed, a protection circuit will automatically turn off the projector. This does not indicate a malfunction. Remove the projector power cord from the wall outlet and wait at least 10 minutes. Place the projector where the intake and exhaust vents are not blocked, plug the power cord back in and turn on the projector. This will return the projector to the normal operating condition.

Cautions regarding the transportation of the projector

- When transporting the projector, be sure not to subject it to hard impact and/or vibration, as this can result in damage. Take extra caution with the lens. Before moving the projector, be sure to unplug the power cord from the wall outlet, and disconnect any other cables connected to it.

Other connected equipment

- When connecting other audio-visual equipment or a computer to the projector, make the connections AFTER turning off the projector and the equipment to be connected.
- Please read the operation manuals of the projector and the equipment to be connected for instructions on how to make the connections.

Temperature monitor function

- If the projector starts to overheat due to setup problems or blockage of the air vents, "TEMP." and "TEMP." will blink in the lower left corner of the picture. If the temperature continues to rise, the lamp will turn off, the temperature warning indicator on the projector will blink, and after a 90-second cooling-off period the power will shut off. Refer to "Maintenance Indicators" on page 74 for details.



Info

- The cooling fan regulates the internal temperature, and its performance is automatically controlled. The sound of the fan may change during projector operation due to changes in the fan speed. This does not indicate malfunction.
- Do not unplug the power cord during projection or cooling fan operation. This can create damage due to the rise in internal temperature, as the cooling fan also stops.





How to Access the PDF Operation Manuals of SharpVision Manager

PDF operation manuals for the “SharpVision Manager” theater projector software provided are included in the CD-ROM in several languages. To utilize these manuals, you need Adobe Acrobat Reader installed on your PC (Windows or Macintosh). If you have not installed Acrobat Reader yet, you can install it from the CD-ROM.

To install Acrobat Reader from the CD-ROM

For Windows:

- ① Insert the CD-ROM in the CD-ROM drive.
- ② Double click the “My Computer” icon.
- ③ Double click the “CD-ROM” drive.
- ④ Double click the “ACROBAT” folder.
- ⑤ Double click the language (name of the folder) that you want to view.
- ⑥ Double click the installation program and follow the instructions on the screen.

For Macintosh:

- ① Insert the CD-ROM in the CD-ROM drive.
- ② Double click the “CD-ROM” icon.
- ③ Double click the “ACROBAT” folder.
- ④ Double click the language (name of the folder) that you want to view.
- ⑤ Double click the installation program and follow the instructions on the screen.

For other operating systems:

Please download Acrobat Reader from the Internet (<http://www.adobe.com>).

For other languages:

If you prefer using Acrobat Reader for languages other than those included in the CD-ROM, please download the appropriate version from the Internet.

Accessing the PDF Manuals

For Windows:

- ① Insert the CD-ROM in the CD-ROM drive.
- ② Double click the “My Computer” icon.
- ③ Double click the “CD-ROM” drive.
- ④ Double click the “MANUALS” folder.
- ⑤ Double click the language (name of the folder) that you want to view.
- ⑥ Double click the “SVM2” pdf file to access the SharpVision Manager manual.

For Macintosh:

- ① Insert the CD-ROM in the CD-ROM drive.
- ② Double click the “CD-ROM” icon.
- ③ Double click the “MANUALS” folder.
- ④ Double click the language (name of the folder) that you want to view.
- ⑤ Double click the “SVM2” pdf file to access the SharpVision Manager manual.

Note

- If the desired pdf file cannot be opened by double clicking the mouse, start Acrobat Reader first, then specify the desired file using the “File”, “Open” menu.
- See the “readme.txt” file on the CD-ROM for important information not included in this operation manual.



Part Names

Numbers in **■** refer to the main pages in this operation manual where the topic is explained.

Projector (Front and Top View)

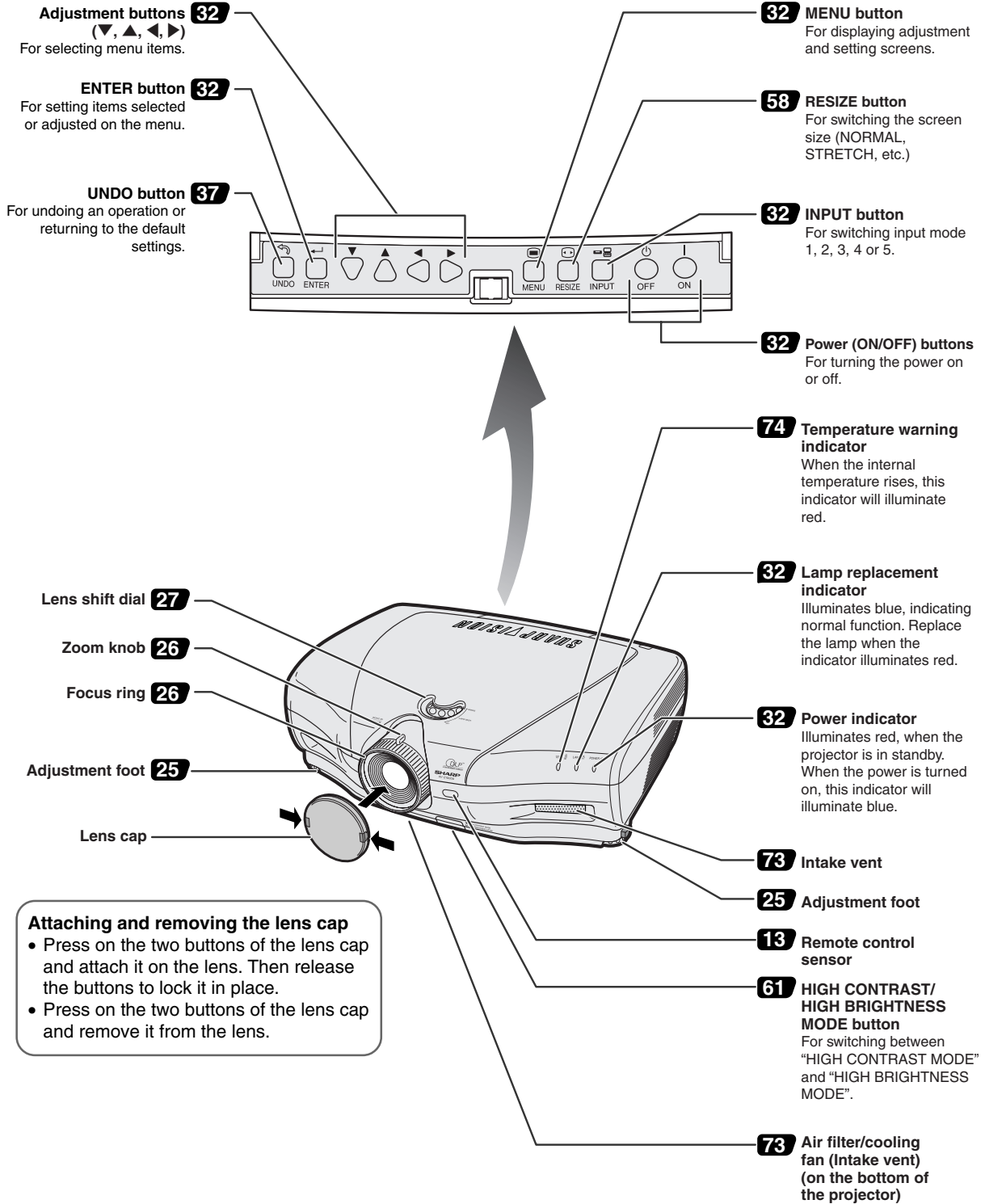

Attaching and removing the lens cap

- Press on the two buttons of the lens cap and attach it on the lens. Then release the buttons to lock it in place.
- Press on the two buttons of the lens cap and remove it from the lens.



Projector (Rear View)

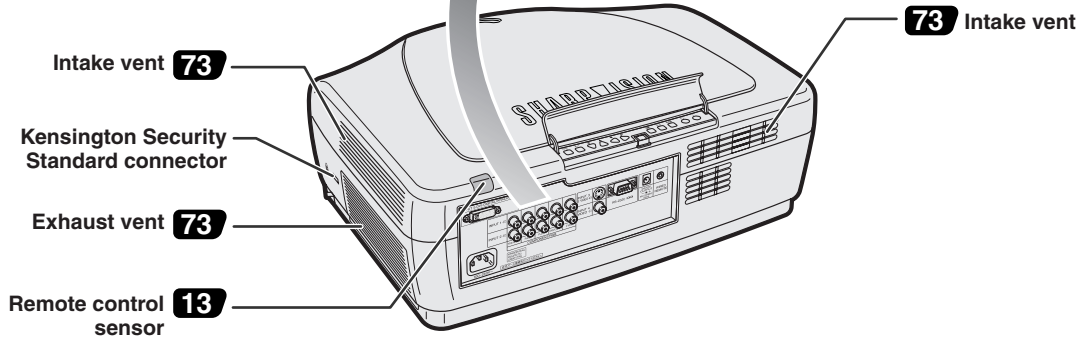
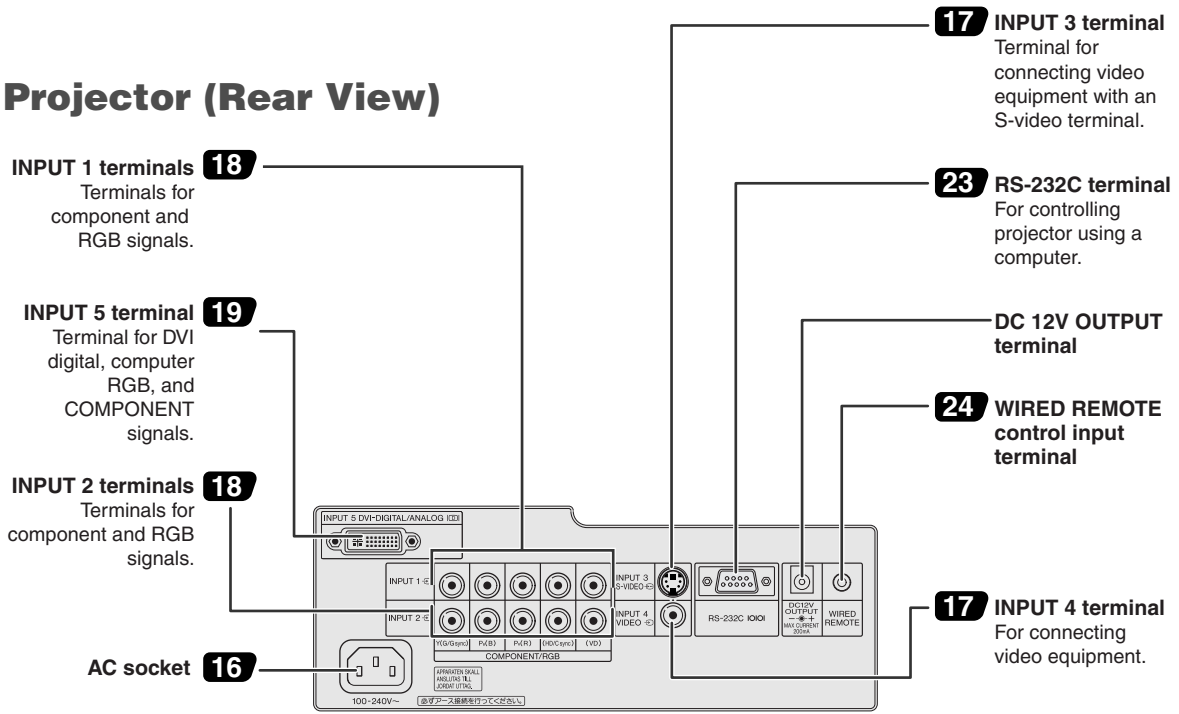

Using the Kensington Lock

This projector has a Kensington Security Standard connector for use with a Kensington MicroSaver Security System. Refer to the information that came with the system for instructions on how to use it to secure the projector.

Using the Terminal Cover

When the projector is used on a desktop, high mounted or ceiling mounted, attach the terminal cover (supplied) to hide the connecting cables.

Attaching the Terminal Cover

- ① Align with the tab on the projector, push the two clips attached on the bottom.
- ② Press the tab to attach to the projector.

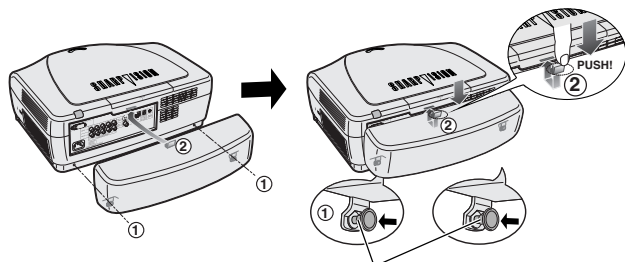

Attach the clips after removing the rubber cap.





Part Names

Remote Control (Front View)

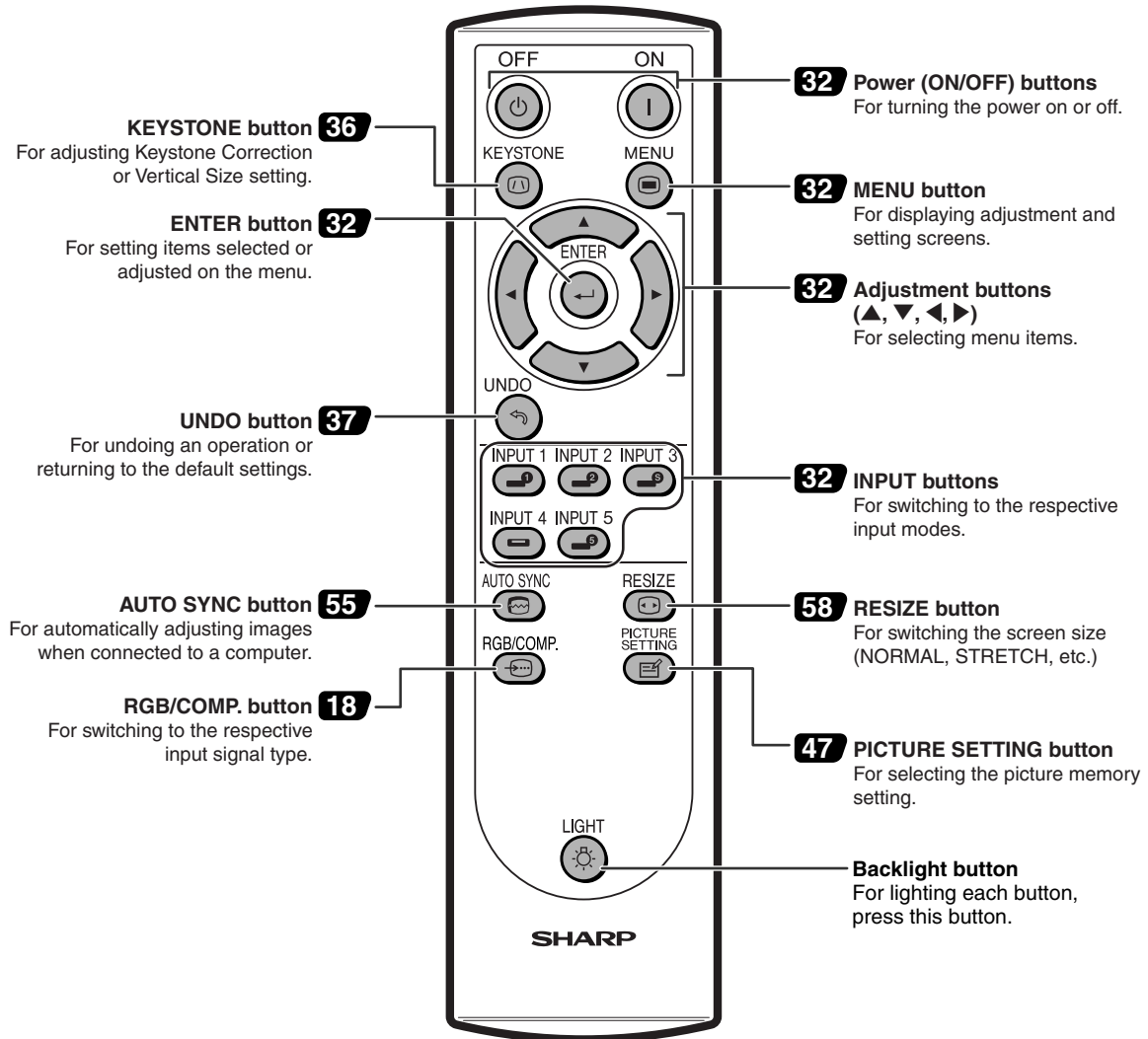

Remote Control (Top View)

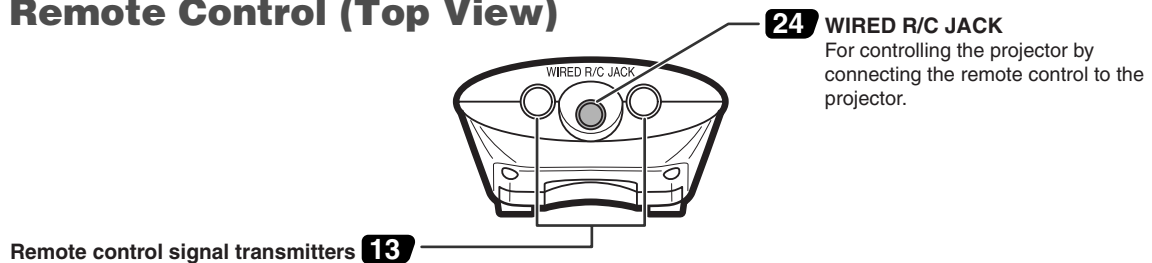



Using the Remote Control

Available Range of the Remote Control

- The remote control can be used to control the projector within the ranges shown in the illustration.

Note

- The signal from the remote control can be reflected off a screen for easy operation. However, the effective distance of the signal may differ due to the screen material.

When using the remote control:

- Be sure not to drop, expose to moisture or high temperature.
- The remote control may malfunction under a fluorescent lamp. Under that circumstance, move the projector away from the fluorescent lamp.

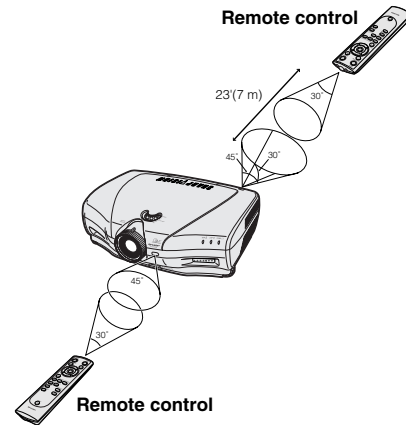

Inserting the Batteries

The batteries (two "AA" size) are included in the package.

- 1 Pull down the tab on the cover and remove the cover towards the direction of the arrow.**
- 2 Insert the included batteries.**
 - Insert the batteries making sure the polarities correctly match the (+) and (-) marks inside the battery compartment.
- 3 Insert the lower tab of the cover into the opening, and lower the cover until it clicks in place.**

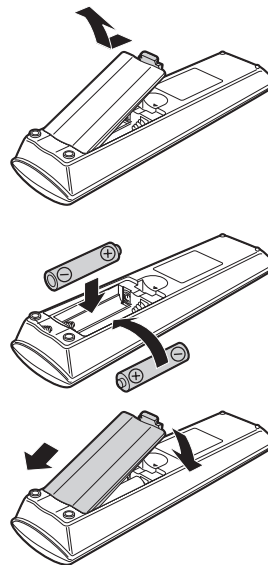

Incorrect use of the batteries may cause them to leak or explode. Please follow the precautions below.

⚠ Caution

- Insert the batteries making sure the polarities correctly match the (+) and (-) marks inside the battery compartment.
- Batteries of different types have different properties, therefore do not mix batteries of different types.
- Do not mix new and old batteries.
This may shorten the life of new batteries or may cause old batteries to leak.
- Remove the batteries from the remote control once they have run out, as leaving them can cause them to leak. Battery fluid from leaked batteries is harmful to your skin, therefore be sure to first wipe them and then remove them using a cloth.

- The batteries included with this projector may exhaust over a short period, depending on how they are kept. Be sure to replace them as soon as possible with new batteries when they have run out.
- Remove the batteries from the remote control if you will not be using the remote control for a long time.



Accessories

Supplied accessories



Remote control
RRMCGA128WJSA



Two "AA" size batteries

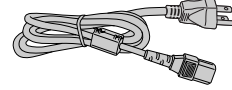

Power cord
CACCGA010DE01

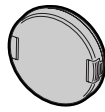

Lens cap (attached)
PCAPH01056CESA

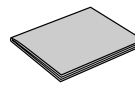

CD-ROM
(SharpVision Manager)
UDSKAA019WJZZ

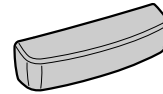

Terminal cover
CCOVA1985CE02

Operation manual (this manual)
TINS-A440WJZZ
SharpVision Manager operation manual
TINS-A452WJZZ

Optional accessories

DVI to 15-pin D-sub adaptor	AN-A1DV
RS-232C cable (32'10" (10.0m))	AN-C10RS
3 RCA to 15-pin D-sub cable (9'10" (3.0m))	AN-C3CP
DVI cable (9'10" (3.0m))	AN-C3DV



Note

- Some of the cables may not be available depending on the region. Please check with your nearest Authorized SharpVision Service Center or Dealer.





Connections and Setup

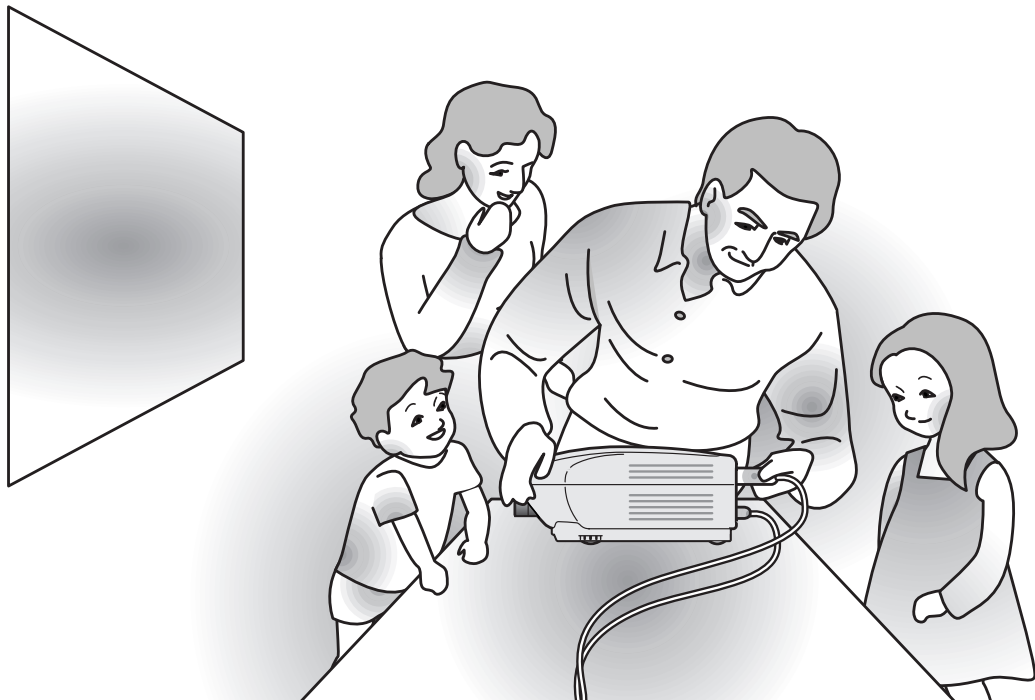

Connections and Setup



Connecting the Projector to Other Devices

Before Connecting



- Before connecting, be sure to turn off both the projector and the devices to be connected. After making all connections, turn on the projector and then the other devices. When connecting a computer, be sure that it is the last device to be turned on after all the connections are made.
- Be sure to read the operation manuals of the devices to be connected before making connections.

This projector can be connected to:

Video equipment:

- A VCR, Laser disc player or other video equipment (See page 17.)
- A DVD player or DTV* decoder (See page 18.)

*DTV is the umbrella term used to describe the new digital television system in the United States.

A computer using:

- DVI to D-sub 15-Pin cable (See page 21.)
- A DVI cable (See page 22.)
- An RS-232C cable (AN-C10RS) (sold separately) (See page 23.)

Connecting the Power Cord

Plug in the supplied power cord into the AC socket on the rear of the projector.

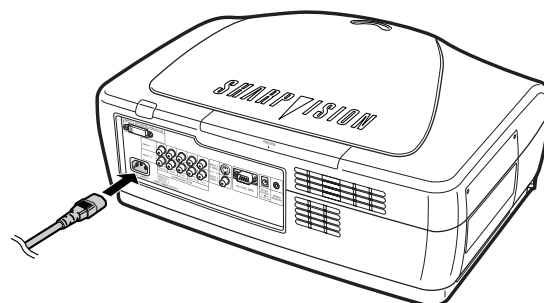
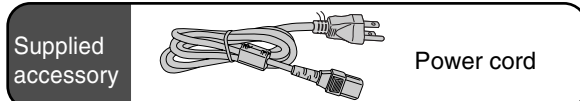



Connecting the Projector to Other Devices

Connecting to Video Equipment

Connecting to Video Equipment Using an S-video or a Composite Video Cable

Using an S-video or a composite video cable, a VCR, laser disc player or other video equipment can be connected to INPUT 3 and INPUT 4 input terminals.

Connect the projector to the video equipment using an S-video cable or a composite video cable (both commercially available).

Note

- The INPUT 3 (S-VIDEO) terminal uses a video signal system in which the picture is separated into color and luminance signals to realize a higher-quality image. To view a higher-quality image, use a commercially available S-video cable to connect the INPUT 3 terminal on the projector and the S-video output terminal on the video equipment.

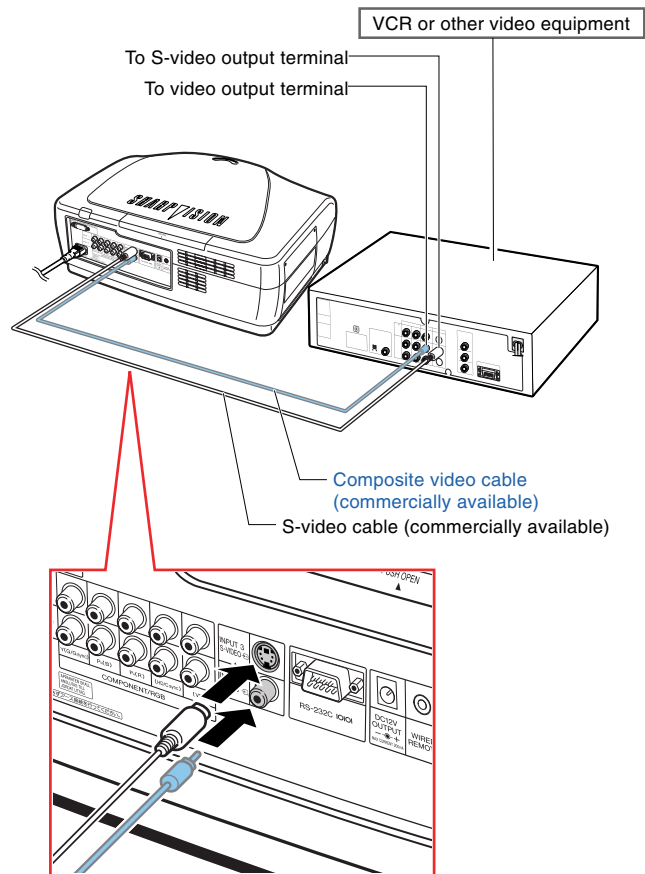



Connecting to Component Video Equipment Using a Component Cable (INPUT 1 or 2)

Use a component cable when connecting to the INPUT 1 or 2 terminal, component video equipment such as DVD players and DTV* decoders.

*DTV is the umbrella term used to describe the new digital television system in the United States.

Connect the projector to the component video equipment using the component cable.

Note

- When connecting the projector to the video equipment in this way, select “Component” for “Signal Type” in the “Options” menu, or select the Component mode by pressing  on the remote control. See page 64.
- Set the “Resolution” of “Special Modes” to “480P” during input of a 525P signal.

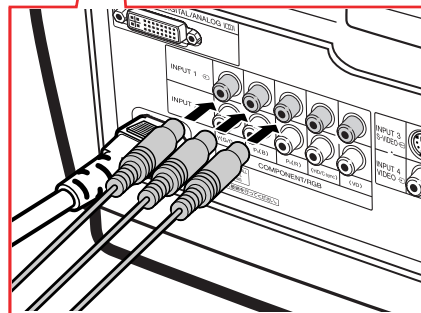
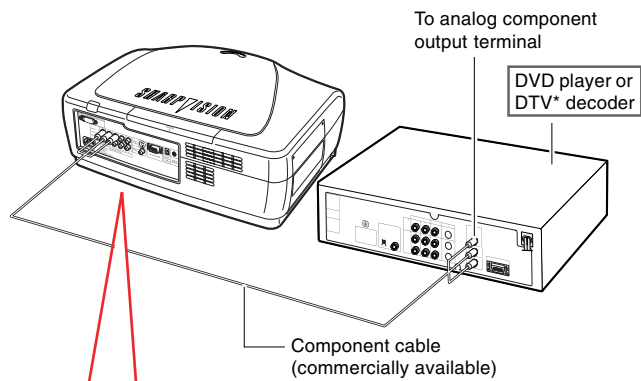

The component jack for a DVD and so forth may be indicated with Y, Cb or Cr. Connect each jack in the manner shown below at this time.

Projector	Y	Pb	Pr
DVD player or DTV decoder	↓	↑	↑
	Y	Cb	Cr

Connecting to RGB Video Equipment Using a 5RCA RGB Cable (INPUT 1 or 2)

Use a 5RCA RGB cable when connecting to the INPUT 1 or 2 terminal, RGB video equipment such as DVD players and DTV* decoders.

Connect the projector to the RGB video equipment using the 5RCA RGB cable.

Note

- When connecting the projector to the video equipment in this way, select “RGB” for “Signal Type” in the “Options” menu, or select the RGB mode by pressing  on the remote control. See page 64.
- The (HD/C sync) and (VD) terminals may be used depending on the specifications of the DTV decoder connected to this projector. Please refer to the operation manual of the DTV decoder for details.

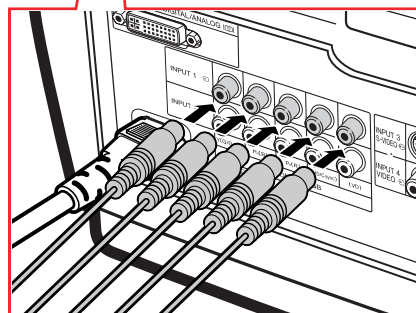
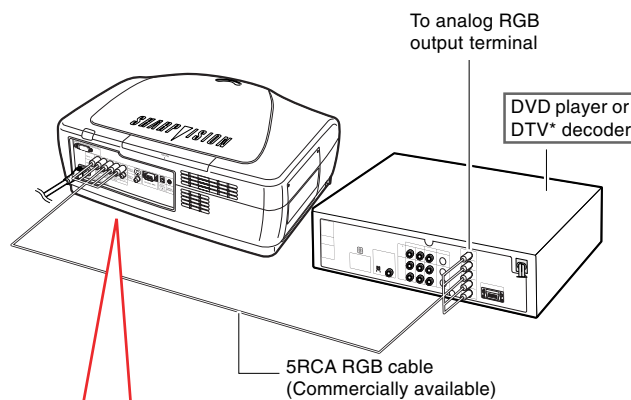



Connecting to Component Video Equipment Using a 3 RCA to 15-pin D-Sub Cable Using the DVI to 15-pin D-Sub adaptor (INPUT 5)

Use a 3 RCA to 15-pin D-Sub cable using the DVI to 15-pin D-Sub adaptor when connecting to the INPUT 5 terminal, component video equipment such as DVD players and DTV* decoders.

*DTV is the umbrella term used to describe the new digital television system in the United States.

Connect the projector to the video equipment using a 3 RCA to 15-pin D-Sub cable using the DVI to 15-pin D-Sub adaptor.

Note

- The component jack for a DVD and so forth may be indicated with Y, CB or CR. Connect each jack in the manner shown below at this time.

Projector	Y	P _B	P _R
DVD player or DTV decoder	↓	↓	↓
	Y	C _B	C _R

Optional accessories

3 RCA to 15-pin D-sub cable
Type: AN-C3CP
(9'10" (3.0 m))

DVI to 15-pin D-sub adaptor
Model: AN-A1DV
(7.9" (20 cm))

DVI to 15-pin D-sub adaptor (sold separately)

To analog component output terminal

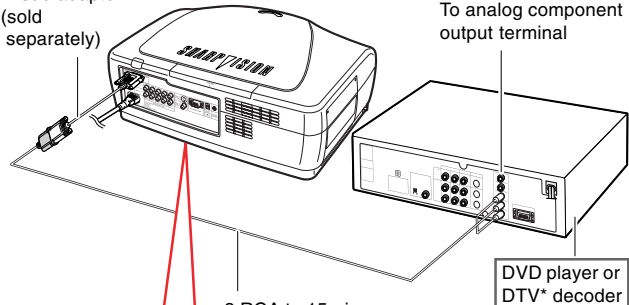

3 RCA to 15-pin D-sub cable (sold separately)

DVD player or DTV* decoder

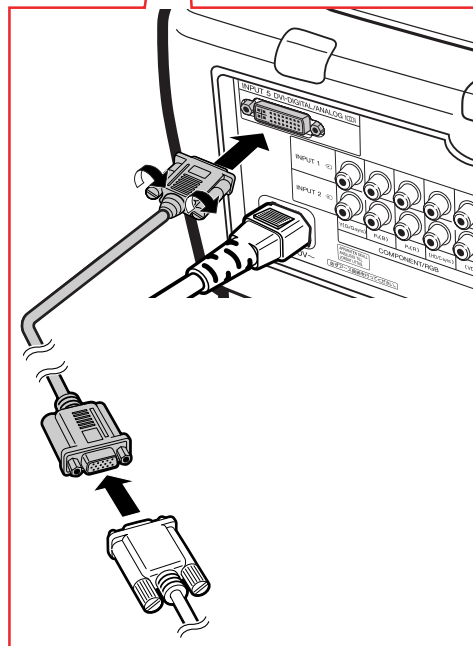



Connecting to Video Equipment with the DVI Output Terminal Using the DVI Cable

Use the DVI cable when connecting to the INPUT 5 terminal, video equipment with the DVI output terminal such as DVD players and DTV* decoders.

*DTV is the umbrella term used to describe the new digital television system in the United States.

Connect the projector to the video equipment using the DVI cable.

Note

- Select the input signal type of the video equipment. See page 64.

Optional accessory

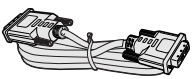

DVI cable
Type:AN-C3DV
(9'10" (3.0m))

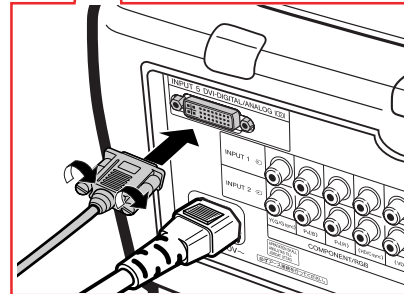
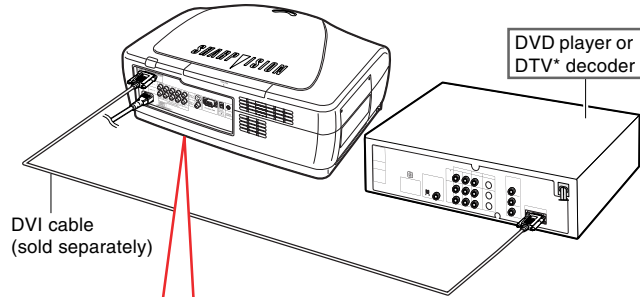



Connecting the Projector to Other Devices

Connecting the Projector to a Computer

Connecting to a Computer Using the the DVI to 15-pin D-sub Adaptor and the RGB Cable

Connect the projector to the computer using the DVI to 15-pin D-sub adaptor and the RGB cable.

- Secure the connectors by tightening the thumbscrews.

Note

- See page 84 “Computer Compatibility Chart” for a list of computer signals compatible with the projector. Use with computer signals other than those listed may cause some of the functions not to work.
- When connecting the projector to a computer in this way, select “RGB” for “Signal Type” in the “Options” menu, or select the RGB mode by pressing  on the remote control. See page 64.
- A Macintosh adaptor may be required for use with some Macintosh computers. Contact your nearest Authorized SharpVision Service Center or Dealer.
- Depending on the computer you are using, an image may not be projected unless the signal output setting of the computer is switched to the external output. Refer to the computer operation manual for switching the computer signal output settings.

Optional accessory

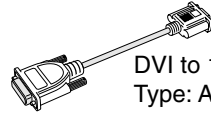

DVI to 15-pin D-sub adaptor
Type: AN-A1DV (7.9" (20cm))

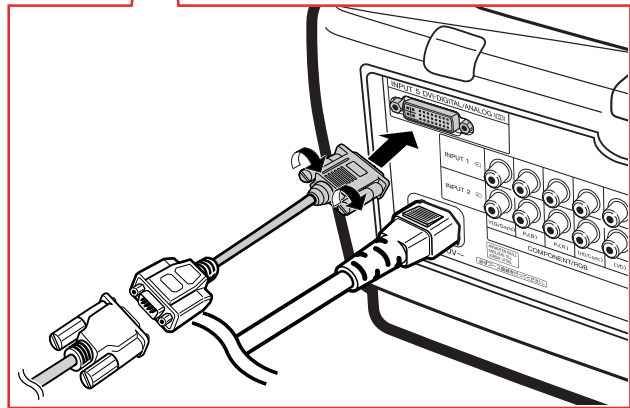
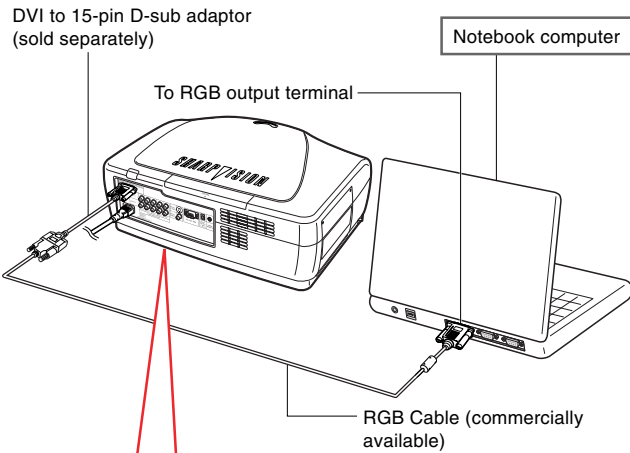



Connecting to a Computer Using a DVI Cable (Sold Separately)

Connect the projector to the computer using the DVI cable.

Note

- Select the input signal type of the video equipment. See page 64.

Optional accessory

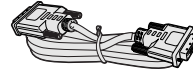

DVI cable
Type:AN-C3DV
(9'10" (3.0m))

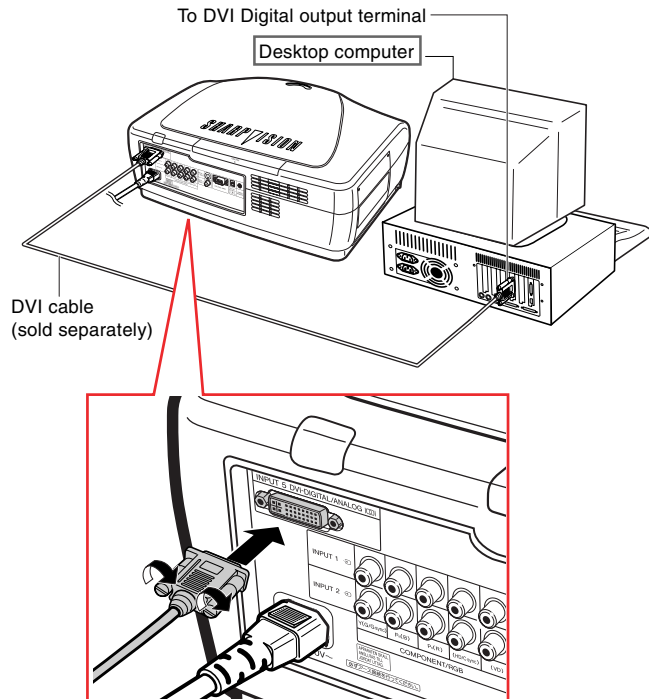

Connecting the thumbscrew cables

- Connect the thumbscrew cable making sure that it fits correctly into the terminal. Then, firmly secure the connectors by tightening the screws on both sides of the plug.
- Do not remove the ferrite core attached to the RGB cable.

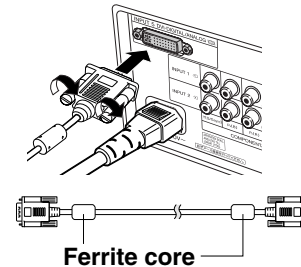

“Plug and Play” function

- This projector is compatible with VESA-standard DDC 1/DDC 2B. The projector and a VESA DDC compatible computer will communicate their setting requirements, allowing for quick and easy setup.
- Before using the “Plug and Play” function, be sure to turn on the projector first and the connected computer last.

Note

- The DDC “Plug and Play” function of this projector operates only when used in conjunction with a VESA DDC compatible computer.





Controlling the Projector by a Computer

Controlling the Projector Using an RS-232C Cable

When the RS-232C terminal on the projector is connected to a computer with an RS-232C cable (null modem, cross type, sold separately), the computer can be used to control the projector and check the status of the projector. See page 80 for details.

Connect the projector to the computer using an RS-232C cable.

Note

- Do not connect or disconnect an RS-232C cable to or from the computer while it is on. This may damage your computer.
- The RS-232C function may not operate if your computer terminal is not correctly set up. Refer to the operation manual of the computer for details.
- See page 79 for connection of an RS-232C cable.

Optional cable
RS-232C cable
Type: AN-C10RS (32'10" (10.0m))

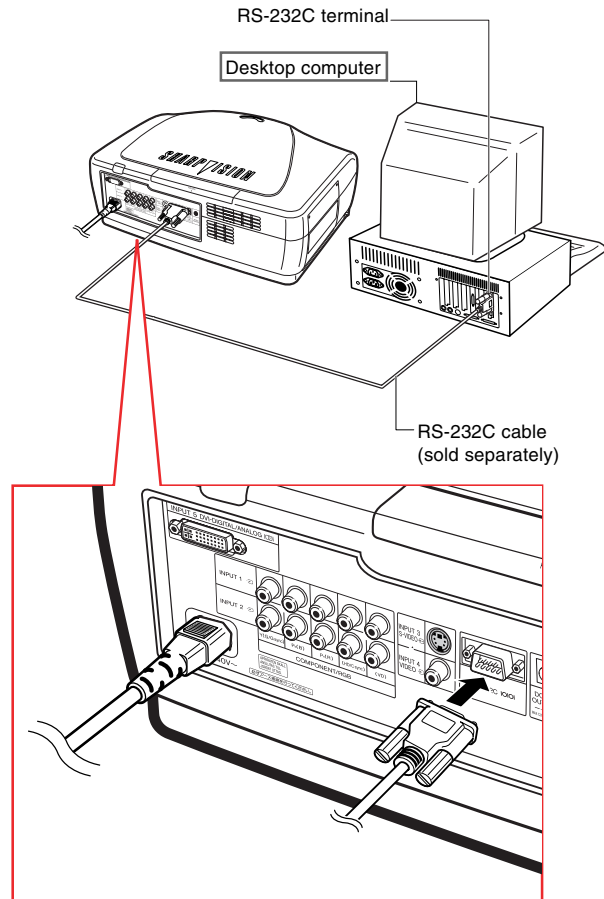



Connecting the Projector to Other Devices

Using as a Wired Remote Control

Connecting the Remote Control to the Projector

When the remote control cannot be used due to the range or positioning of the projector (rear projection, etc.), connect a $\varnothing 3.5$ mm minijack cable (commercially available or available as Sharp service part QCNW-4870CEZZ) from the WIRED R/C JACK on the top of the remote control to the WIRED REMOTE control input terminal.

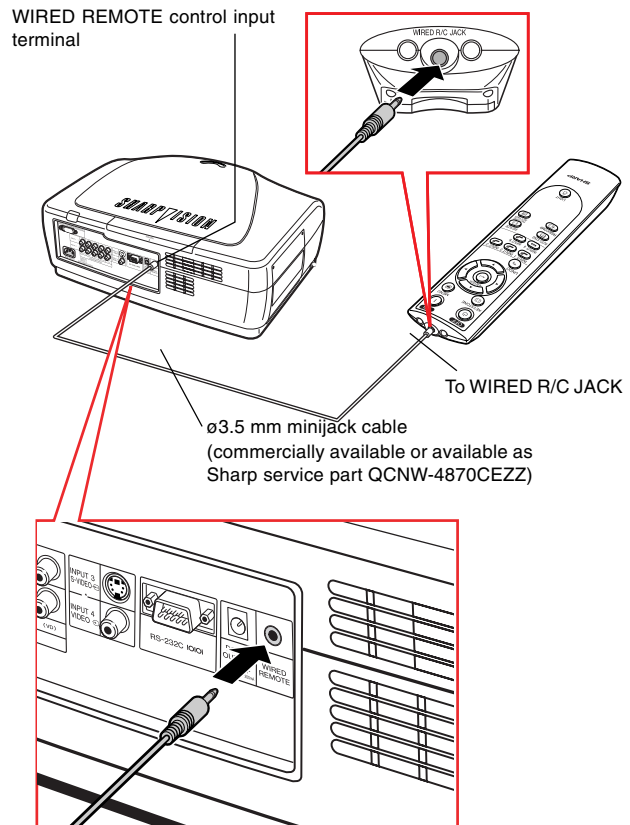



Setup

Using the Adjustment Feet

The height of the projector can be adjusted using the adjustment feet when the surface the projector is placed on is uneven or when the screen is slanted.

The projection of the image can be made higher by adjusting the projector when it is in a location lower than the screen.

1 Press the foot releases and lift the projector to the desired angle.

2 Remove your hands from the foot releases. Once the adjustment feet have locked in position, release the projector.

- If the screen is at an angle, the adjustment feet can be used to adjust the angle of the image.

Note

- The projector is adjustable up to approximately 5 degrees from the standard position.
- When the height of the projector is adjusted, the image may become distorted (keystoned), depending on the relative positions of the projector and the screen. See page 36 for details on the keystone correction.

Info

- Do not hold the lens when lifting or lowering the projector.
- When lowering the projector, be careful not to get your finger caught in the area between the adjustment foot and the projector.

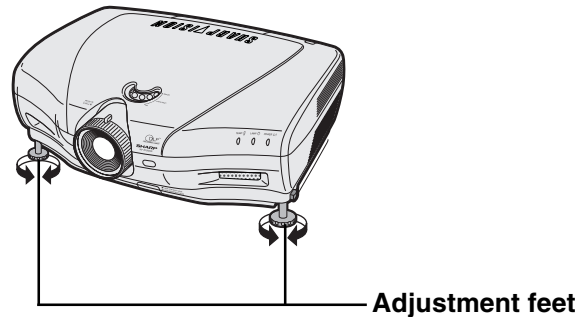
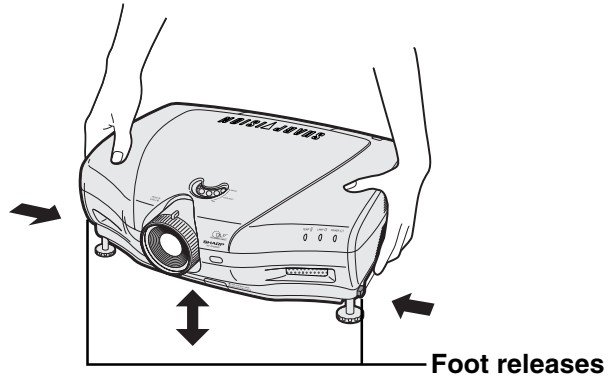



Setup

Adjusting the Lens

The image is focused and adjusted to the desired size using the focus ring or zoom knob on the projector.

- 1** Zooming is adjusted by moving the zoom knob.

- 2** The focus is adjusted by rotating the focus ring.

Focus ring Zoom knob

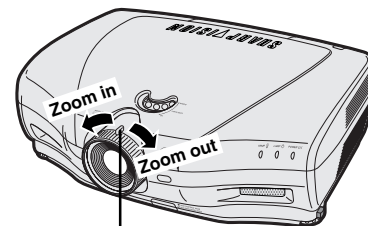
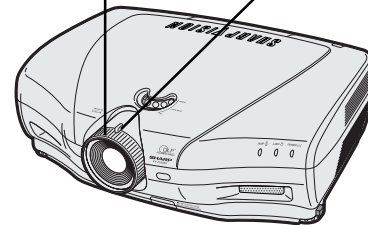

Zoom Knob

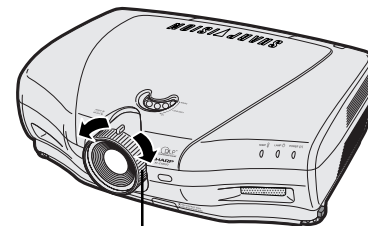

Focus ring



Setup

Using the Lens Shift

The height of the projected image can be adjusted within the shift range of the lens by rotating the lens shift dial on the top of the projector.

Note

- Do not forcibly turn the lens shift dial beyond the range of the upper limit and lower limit positions. This may cause the projector to malfunction.

Selecting the HIGH CONTRAST/ HIGH BRIGHTNESS MODE

Pressing the HIGH CONTRAST/HIGH BRIGHTNESS MODE button switches between the contrast emphasis mode and brightness emphasis mode. See page 61 for details.

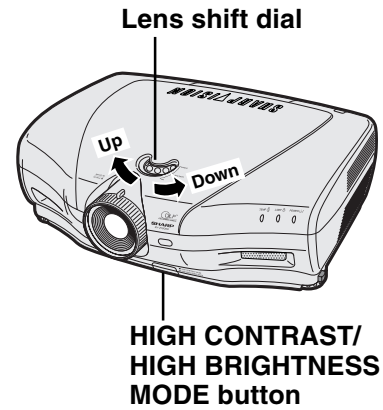



Setting up the Screen

Position the projector perpendicular to the screen with all feet flat and level to achieve an optimal image.

Note

- The projector lens should be centered in the middle of the screen. If the horizontal line passing through the lens center is not perpendicular to the screen, the image will be distorted, making viewing difficult.
- For optimal image, position the screen so that it is not in direct sunlight or room light. Light falling directly on the screen washes out the colors, making viewing difficult. Close the curtains and dim the lights when setting up the screen in a sunny or bright room.
- A polarizing screen cannot be used with this projector.

Standard Setup (Front Projection)

- Place the projector at the required distance from the screen according to the desired picture size. (See page 29.)

Example of Standard Setup

Side View

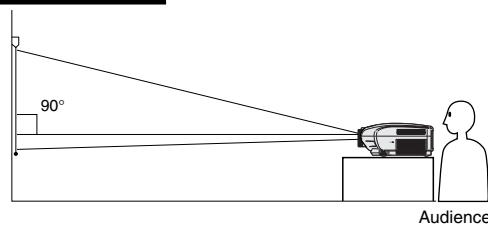

- The distance from the screen to the projector may vary depending on the size of the screen.

P.29

- The default setting can be used, when placing the projector in front of the screen. If the projected image is reversed or inverted, readjust the setting to "Front" for "PRJ Mode" in the "Options" menu.

P.69

Top View

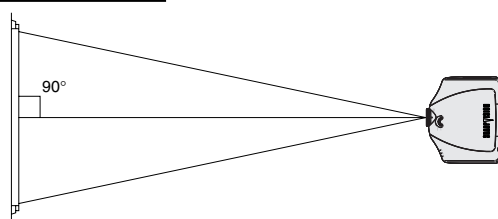

- Place the projector so that an imaginary horizontal line that passes through the center of the lens is perpendicular to the screen.



Setup

Screen Size and Projection Distance

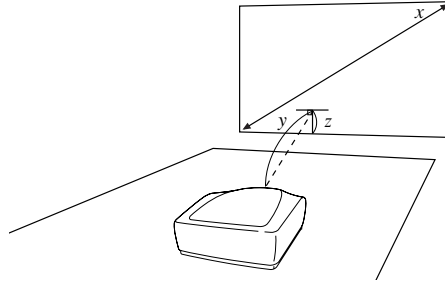

When using a normal screen (4:3)

In case of setting the 16:9 picture to the full horizontal width of the 4:3 screen.

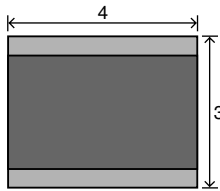

□ : Screen area
■ : Picture area

Screen size (4:3)			Projection Distance (y)		Distance from the lens center to the lower edge of the image (z)	
Diag. (x)	Width	Height	Maximum (y ₁)	Minimum (y ₂)	Upper (z ₁)	Lower (z ₂)
250"	200"	150"	41'4" (12.6 m)	30'6" (9.3 m)	0" (0 cm)	-12'6" (-286 cm)
200"	160"	120"	33' (10.1 m)	24'4" (7.4 m)	0" (0 cm)	-10' (-229 cm)
150"	120"	90"	24'9" (7.5 m)	18'3" (5.6 m)	0" (0 cm)	-7'6" (-171 cm)
100"	80"	60"	16'5" (5.0 m)	12'1" (3.7 m)	0" (0 cm)	-5' (-114 cm)
84"	67"	50"	13'9" (4.2 m)	10'2" (3.1 m)	0" (0 cm)	-4'2" (-96 cm)
72"	58"	43"	11'10" (3.6 m)	8'8" (2.6 m)	0" (0 cm)	-3'7" (-82 cm)
60"	48"	36"	9'10" (3.0 m)	7'2" (2.2 m)	0" (0 cm)	-3' (-69 cm)

The formula for screen size and projectino distance

$$y_1 (\text{Max.}) = (0.05058x - 0.0447) \times 3.28$$

$$y_2 (\text{Min.}) = (0.03734x - 0.0447) \times 3.28$$

$$z_1 (\text{Upper}) = 0$$

$$z_2 (\text{Lower}) = -0.45x$$

x : Screen size (diag.) (inches)

y : Projection distance (feet)

z : Distance from the lens center to the lower edge of the screen (feet)

Note

- There is an error of $\pm 3\%$ in the formula above.
- Values with a minus (-) sign indicate the distance of the lens center below the bottom of the screen.

When using a wide screen (16:9)

In case of displaying the 16:9 picture on the whole of the 16:9 screen.



■ : Picture area

Screen size (16:9)			Projection Distance (y)		Distance from the lens center to the lower edge of the image (z)	
Diag. (x)	Width	Height	Maximum (y ₁)	Minimum (y ₂)	Upper (z ₁)	Lower (z ₂)
300"	261"	147"	54'1" (16.5 m)	39'11" (12.2 m)	0" (0 cm)	-12'3" (-374 cm)
250"	218"	123"	45'1" (13.7 m)	33'3" (10.1 m)	0" (0 cm)	-10'3" (-311 cm)
200"	174"	98"	36' (11.0 m)	26'7" (8.1 m)	0" (0 cm)	-8'2" (-249 cm)
150"	131"	74"	26'12" (8.2 m)	19'11" (6.1 m)	0" (0 cm)	-6'2" (-187 cm)
133"	116"	65"	23'11" (7.3 m)	17'7" (5.4 m)	0" (0 cm)	-5'5" (-166 cm)
106"	92"	52"	18'11" (5.8 m)	13'11" (4.3 m)	0" (0 cm)	-4'4" (-131 cm)
100"	87"	49"	17'11" (5.5 m)	13'2" (4.0 m)	0" (0 cm)	-4'1" (-125 cm)
92"	80"	45"	16'5" (5.0 m)	12'1" (3.7 m)	0" (0 cm)	-3'9" (-114 cm)
84"	73"	41"	15' (4.6 m)	11'1" (3.4 m)	0" (0 cm)	-3'5" (-105 cm)
72"	63"	35"	12'10" (3.9 m)	9'6" (2.9 m)	0" (0 cm)	-2'11" (-90 cm)
60"	52"	29"	10'8" (3.3 m)	7'10" (2.4 m)	0" (0 cm)	-2'5" (-75 cm)
40"	35"	20"	7'1" (2.2 m)	5'2" (1.6 m)	0" (0 cm)	-1'8" (-50 cm)

The formula for screen size and projectino distance

$$y_1 (\text{Max.}) = (0.05510x - 0.04593) \times 3.28$$

$$y_2 (\text{Min.}) = (0.04068x - 0.04369) \times 3.28$$

$$z_1 (\text{Upper}) = 0$$

$$z_2 (\text{Lower}) = -0.4904x$$

x : Screen size (diag.) (inches)

y : Projection distance (feet)

z : Distance from the lens center to the lower edge of the screen (feet)

Note

- There is an error of $\pm 3\%$ in the formula above.
- Values with a minus (-) sign indicate the distance of the lens center below the bottom of the screen.



Setup

Projecting a Reversed/Inverted Image

Projection from behind the screen

- Place a translucent screen between the projector and the audience.
- Reverse the image by setting “Rear” for “PRJ Mode” in the “Options” menu. See page 69 for use of this function.

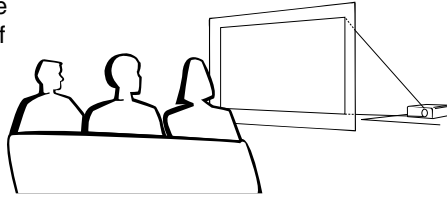

Projection using a mirror

- Place a mirror (normal flat type) in front of the lens.
- Reverse the image by setting “Rear” for “PRJ Mode” in the “Options” menu, when the mirror is placed on the audience side. See page 69 for use of this function.

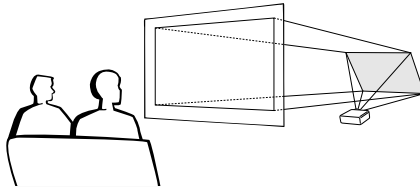

Info

- When using a mirror, be sure to carefully position both the projector and the mirror so the light does not shine into the eyes of the audience.

Ceiling-mount setup

- It is recommended that you use the optional Sharp ceiling-mount bracket for this installation.
- Before mounting the projector, contact your nearest Authorized SharpVision Service Center or Dealer to obtain the recommended ceiling-mount bracket (sold separately). (AN-CM250 ceiling-mount bracket, AN-EP101B extension tube for AN-CM250.)
- Be sure to adjust the position of the projector to match the distance (Z) from the lens center position (see page 29) to the lower edge of the image, when mounting the projector on the ceiling.
- Invert the image by setting “Ceiling + Front” for “PRJ Mode” in the “Options” menu. See page 69 for use of this function.

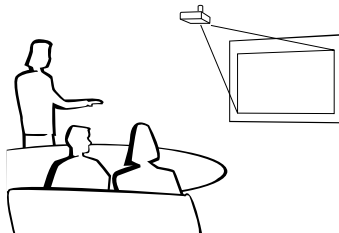

When using the default setting.

▼On-screen Display

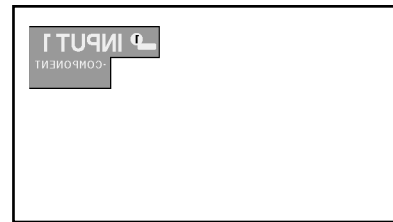

The image is reversed.

When using the default setting.

▼On-screen Display

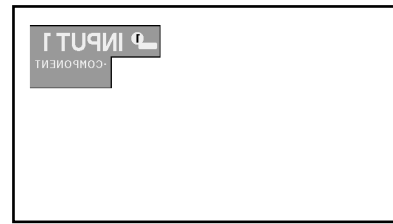

The image is reversed.

When using the default setting.

▼On-screen Display

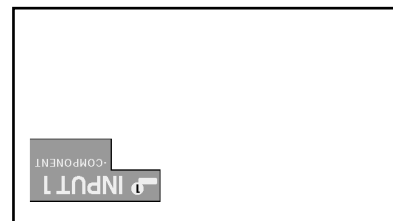

The image is inverted.



Basic Operation

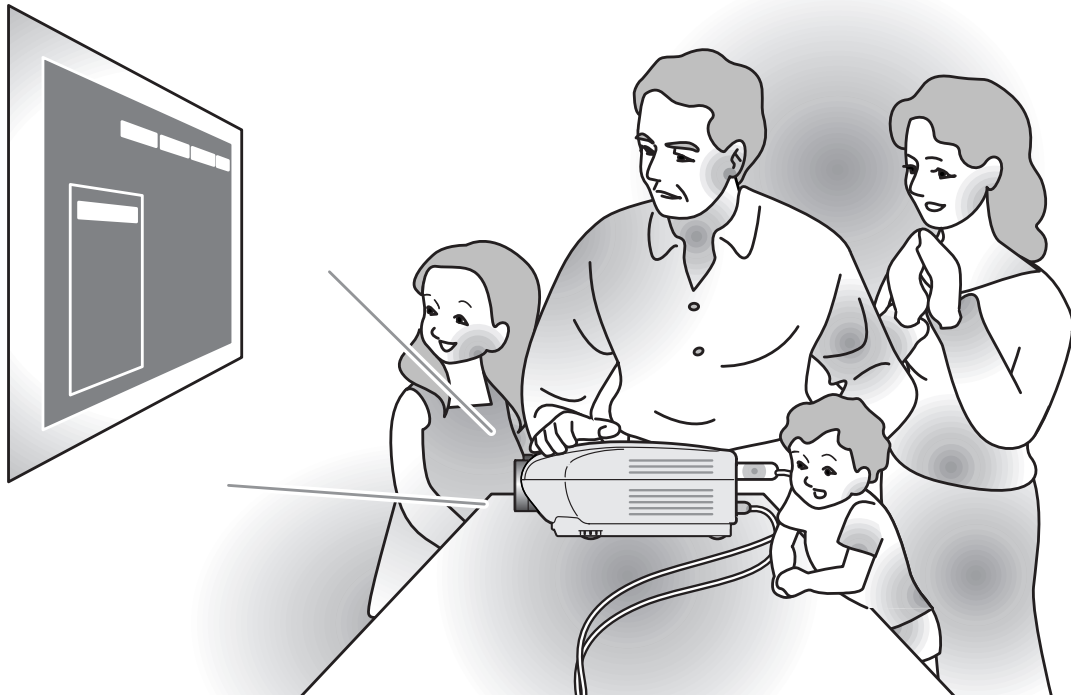

Basic Operation

Image Projection

Basic Procedure

Connect the required external equipment to the projector before operating the following procedures.

Info

- The language preset at the factory is English. If you want to change the on-screen display to another language, reset the language according to the procedure on page 34.

1 Plug the power cord into the wall outlet.

- The power indicator illuminates red, and the projector enters standby mode.

2 Press on the remote control or on the projector.



- The power indicator illuminates blue. After the lamp replacement indicator illuminates, the projector is ready to start operation.

Note

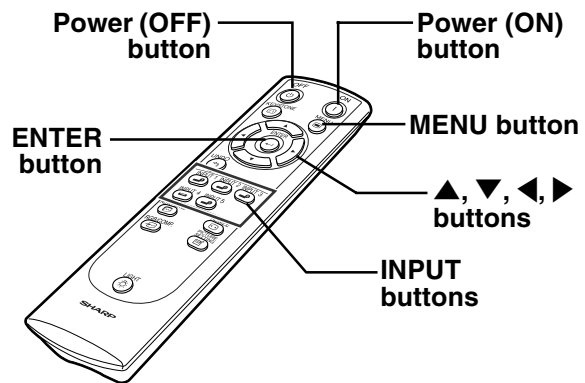
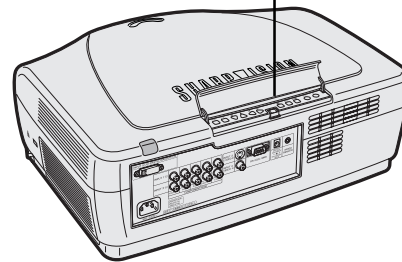
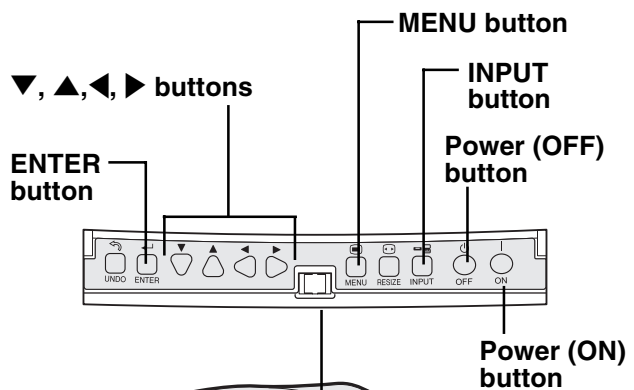
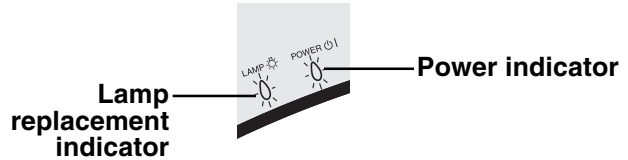
- The lamp replacement indicator illuminates, indicating the status of the lamp.
 - Blue:** The lamp is ready.
 - Blue blinking:** The lamp is warming up.
 - Red:** The lamp should be replaced.
- If the power is turned off and immediately switched on again, the lamp replacement indicator may take time to illuminate.
- When controlling the projector using RS-232C commands from a computer, wait for at least 30 seconds after the power has been turned on, and then transmit the commands.



3 Press , , , or on the remote control or on the projector to select the INPUT mode.

- After pressing  once on the projector, use  to select the desired input mode.

Note

- When no signal is received, "NO SIGNAL" will be displayed. When a signal that the projector is not preset to receive is received, "NOT REG." will be displayed.
- The INPUT mode is not displayed when "OSD display" is set to "Level A" or "Level B". (See page 63.)

About the INPUT modes

INPUT 1	Used for projecting images from equipment that sends component signals or RGB signals connected to the INPUT 1 or 2 terminal.
INPUT 2 (Component/RGB*)	
INPUT 3 (S-Video)	Used for projecting images from equipment connected to the S-VIDEO input terminal.
INPUT 4 (Video)	Used for projecting images from equipment connected to the VIDEO input terminal.
INPUT 5 (Digital PC RGB/ Digital PC Component/ Digital Video RGB/Digital Video Component/ Analog RGB/ Analog Component)	Used for projecting images from equipment connected to the DVI input terminal.

* Input the RGB signal of the DTV, not the computer.

▼ On-screen Display (Example)

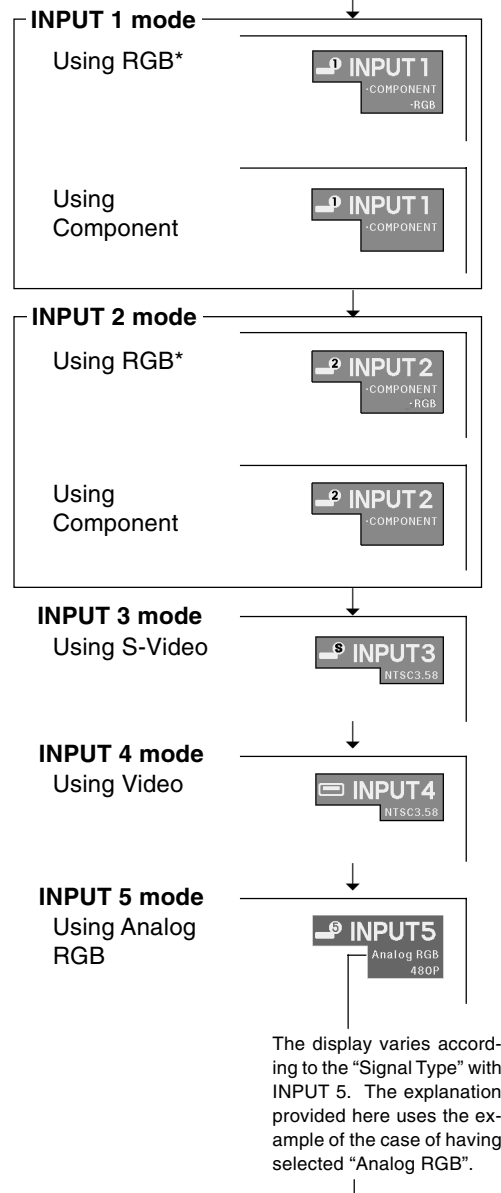









Image Projection

- 4** Press  on the remote control or  on the projector, then press  or  again while the confirmation message is displayed, to turn off the projector.

Note

- If you accidentally pressed  and do not want to turn off the power, wait until the confirmation message disappears.

Info

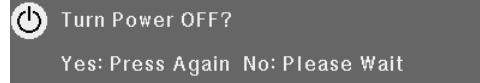
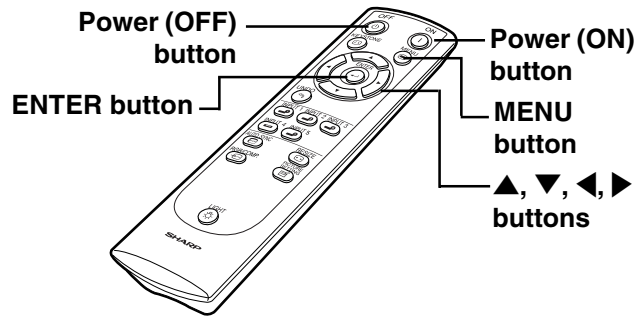

- Do not unplug the power cord during projection or cooling fan operation. This can cause damage due to the rise in internal temperature, as the cooling fan also stops.
- When connected to equipment such as an amplifier, be sure to turn off the power to the equipment connected first and then to the projector.



Selecting the On-screen Display Language

- The on-screen display language of the projector can be set to English, German, Spanish, Dutch, French, Italian, Swedish, Portuguese, Chinese, Korean or Japanese.

- 1** Press .
- The menu will be displayed.

- 2** Press  or  to select “Language”.

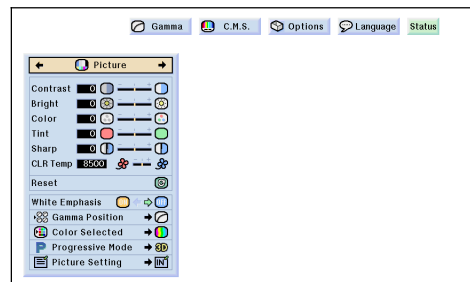



3 Press ▲ or ▼ to select the desired language, and then press



4 Press .

- The desired language will be set as the on-screen display.





Keystone Correction and Vertical Size Adjustment

Correcting Trapezoidal Distortion and Adjusting the Vertical Size of the Picture

This function allows for Keystone (On-screen Trapezoidal Distortion) Correction and the adjustment of the vertical size of the picture.

Note

- When the image is projected either from top or from bottom toward the screen at an angle, the image becomes distorted trapezoidally. The function for correcting trapezoidal distortion is called Keystone Correction.
- The Keystone Correction can be adjusted up to angle of approximately ± 30 degrees.
- There are some input signal in which "KEystone" does not work.

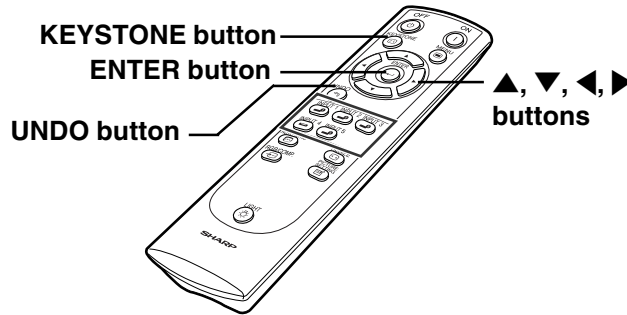

1 Press .

- Pressing switches the settings in the manner shown in the diagram at right each time it is pressed.

2 Press $\blacktriangle, \blacktriangledown, \blacktriangleleft$ and \blacktriangleright to adjust the Keystone correction.

- If you want to make more detailed corrections, press to display the test pattern, and then press $\blacktriangledown, \blacktriangle, \blacktriangleleft$ and \blacktriangleright to make the adjustments.

Note

- Since the trapezoidal distortion of the image can be corrected up to an angle of approximately ± 30 degrees, the actual screen can be diagonally set up to that angle as well.
- Press to cancel Keystone Correction.
- Straight lines or the edges of images may appear jagged while adjusting the image.

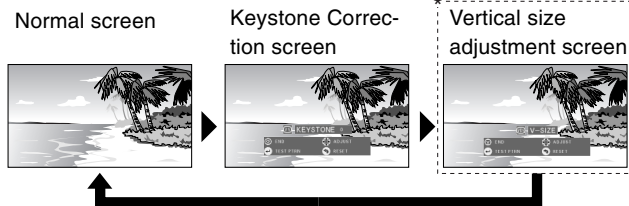

* "V-SIZE" is not displayed when the value of "KEystone" is "0".

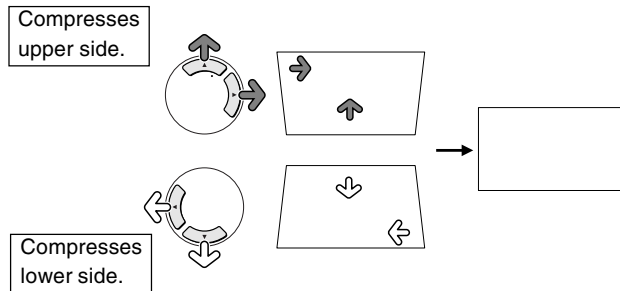

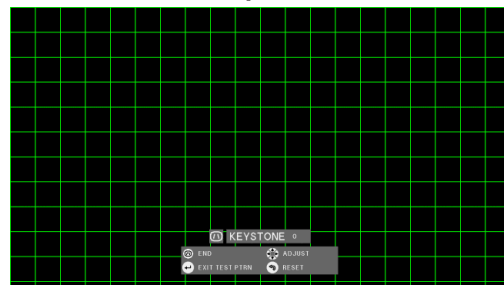

Test pattern







3 When adjusting vertical size, pressing  again displays the vertical size adjustment menu.

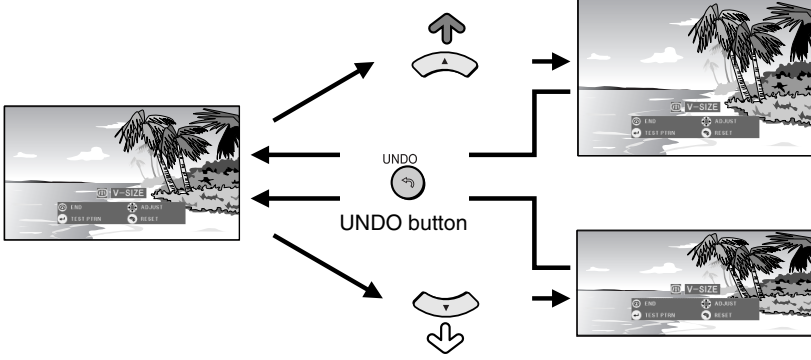

4 Press  and  to adjust the vertical size of the picture, and press .

- See below for details about the vertical size adjustment.

Vertical Size Adjustment The screen aspect ratio may change when the lens shift function is used in combination with the Keystone Correction function. In this case, adjust the aspect ratio using the vertical size adjustment.



Pressing  increases the vertical length of the image. Press  to reset the image.

Pressing  decreases the vertical length of the image. Press  to reset the image.



Menu Bar Items

This list shows the items that can be set in the projector.

■ INPUT 1 / 2 / 5 Mode

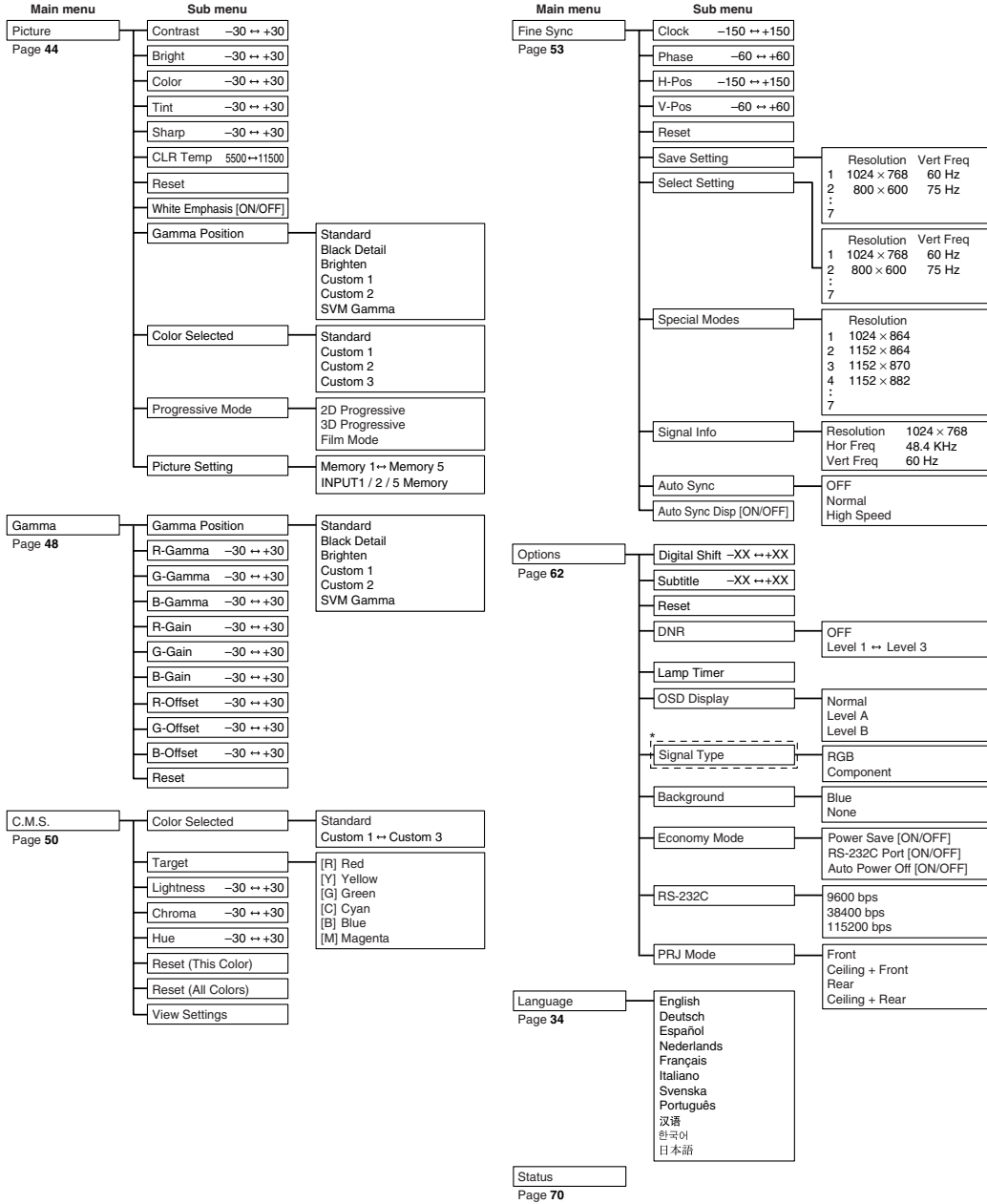

*In INPUT 5, the items in "Signal Type" are "D. PC RGB", "D. PC Comp.", "D. Video RGB", "D. Video Comp." "A. RGB" and "A. Comp.".

Note

- The resolution, vertical frequency and horizontal frequency figures displayed above are for example purposes only.
- Picture adjustment settings differ depending on the type of input signal.



INPUT 3 / 4 Mode

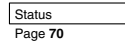
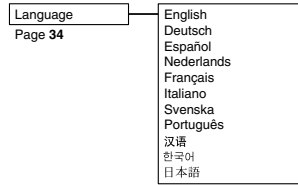
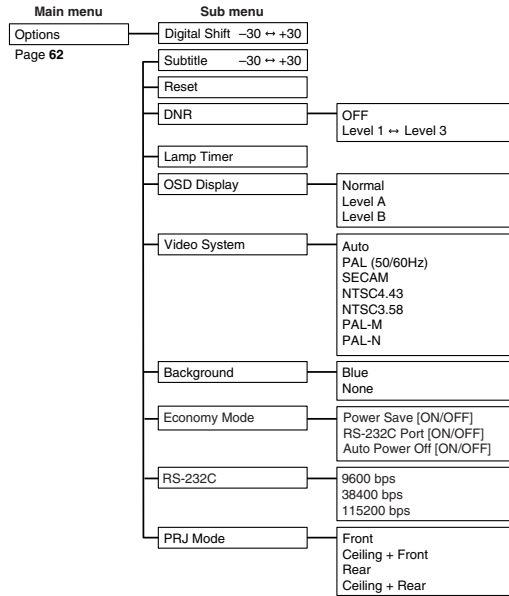
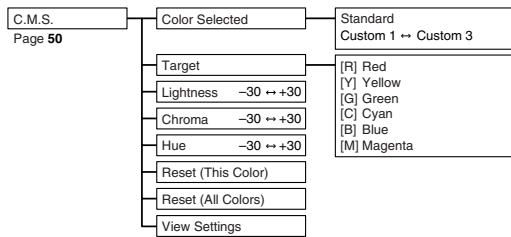
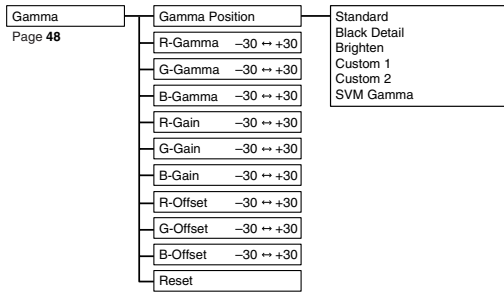
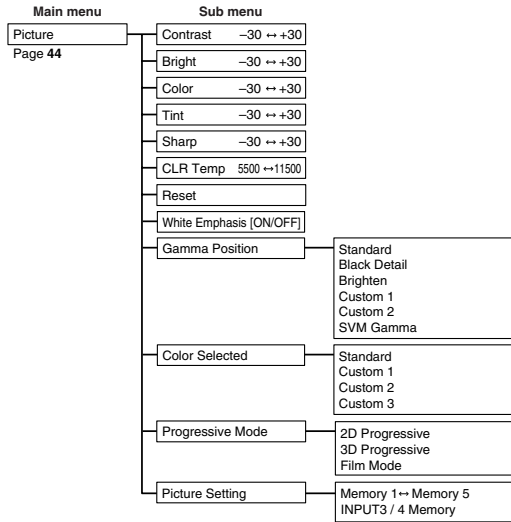



Using the Menu Screen

This projector has two sets of menu screens that allow you to adjust the image and various projector settings. You can operate the menus from the projector or remote control using the following procedure.

Menu screen for INPUT 1, INPUT 2 or INPUT 5 RGB mode

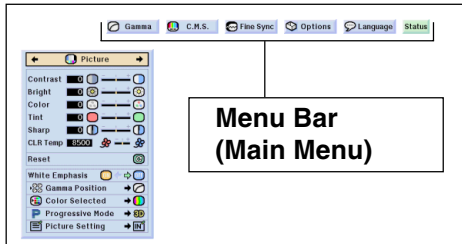

Menu screen for INPUT 3, INPUT 4 or INPUT 5 VIDEO Mode

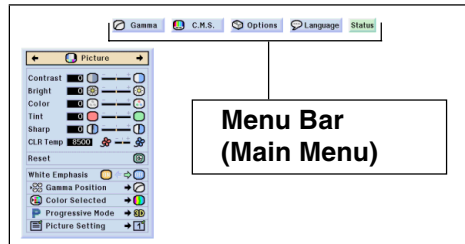

Menu Selections (Adjustments)

1 Press .

- The menu screen is displayed.

Note

- The "Picture" menu screen for the selected input mode is displayed.
- The on-screen display shown on the lower right is displayed when the INPUT 1, 2 or INPUT 5 RGB mode is selected.

▼, ▲, ◀, ▶ buttons

ENTER button

MENU button

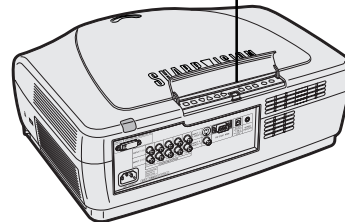
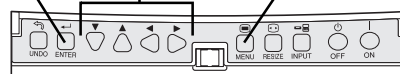

ENTER button

MENU button

▲, ▼, ◀, ▶ buttons

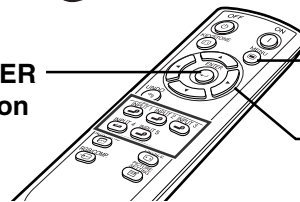

▼ Menu Screen

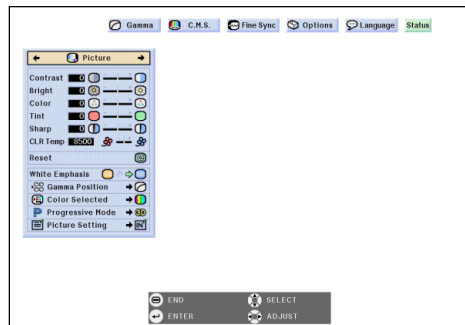



2 Press ◀ or ▶ to select the menu you want to adjust.





- For details on the menus, see the tree charts on pages 38 and 39.

3 Press ▼ or ▲ to select the item you want to adjust.

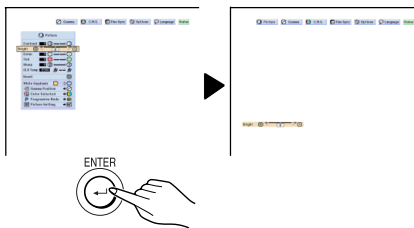

- To display a single adjustment item, press  after selecting the item. Only the menu bar and the selected adjustment item will be displayed. Then if you press ▲ or ▼, the following item (“Bright” after “Contrast”) will be displayed.



- Press  or  to return to the previous screen.

4 Press ◀ or ▶ to adjust the item selected.

- The adjustment is stored.

5 Press .

- The menu screen will disappear.

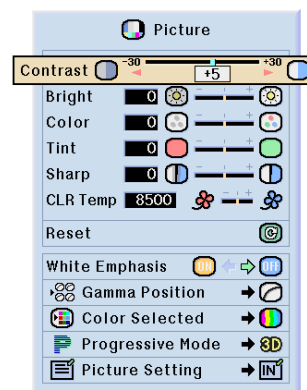
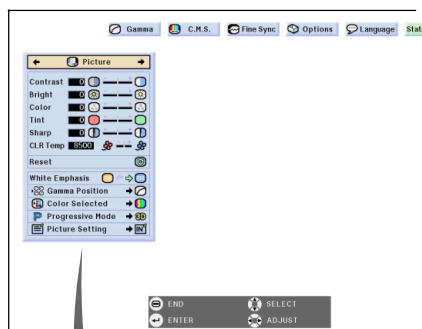



Using the Menu Screen

Menu Selections (Settings)

1 Press .

• The menu screen is displayed.



 **Note**

- The "Picture" menu screen for the selected input mode is displayed.
- The on-screen displays shown on the lower right is displayed when INPUT 1, 2 or INPUT 5 RGB mode is selected.



2 Press  or  to select the menu you want to adjust.

 **Note**

- For details on the menus, see the tree charts on pages 38 and 39.

3 Press  or  to select the item you want to set.

 **Note**

- Press  to return to the previous screen.
- In some menus, select the icon using .

buttons

ENTER button

MENU button

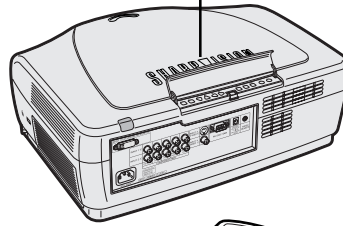
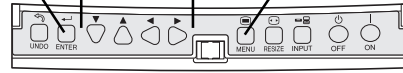

ENTER button

MENU button

buttons

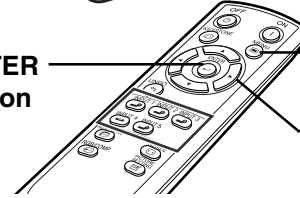

▼ Menu screen

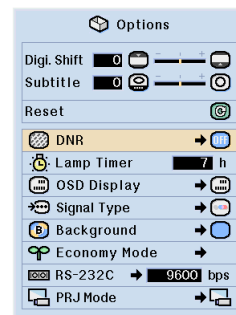

Sub menu





4 Press ►.



- The cursor shifts to the sub menu.

5 Press ▼ or ▲ to select the setting of the item displayed in the sub menu.

6 Press .

- The item selected is set.

Note

- Some adjustment items will display a confirmation message. When setting an item, press ◀ or ▶ to select “Yes” or “OK” and then press .
- Use  to select “ON” or “OFF” for the item of “Economy Mode”.

7 Press .

- The menu will disappear.

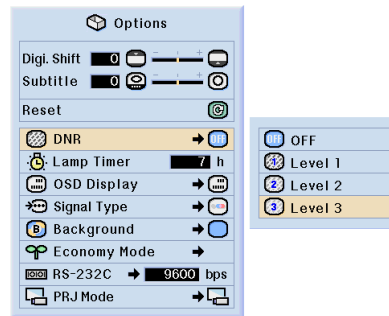
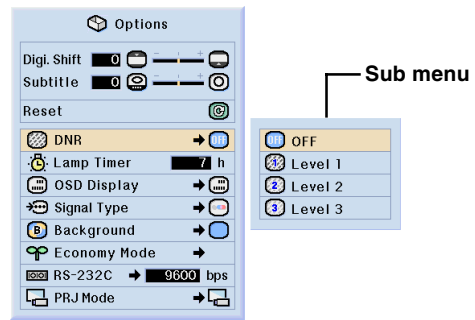



Adjusting the Picture

You can adjust the projector's picture to your preferences with the following picture settings.



Adjusting Image Preferences

Note

- First select "INPUT # Memory" when you want to save the "Picture" menu settings. See page 47 for details.

Adjust the "Picture" menu on the menu screen.

→For operating the menu screen, see pages 40 to 43.



Selected Item	Description	◀ button	▶ button
Contrast	For adjusting the contrast level	For less contrast	For more contrast
Bright	For adjusting the brightness of an image	For less brightness	For more brightness
Color	For adjusting the color intensity of an image	For less color intensity	For more color intensity
Tint	For adjusting the tones of an image	Skin tones become purplish	Skin tones become greenish
Sharp	For making sharper or softer the contour of an image	For less sharpness	For more sharpness
CLR Temp	For adjusting the color temperature of an image	Decreases color temperature for warmer, reddish, incandescent-like images.	Increases color temperature for cooler, bluish, fluorescent-like images.

Note

- Picture adjustment settings differ depending on the type of input signal.
- The picture adjustments can be stored separately in each input mode.
- Some parameters may not be able to be adjusted depending on the combination of INPUT mode and "Signal Type".
- To reset all adjustment items, select "Reset" and press .



Emphasizing the Contrast

This function emphasizes the bright portions of images to obtain a higher contrast image.

Select “White Emphasis” in the “Picture” menu on the menu screen.
→For operating the menu screen, see pages 40 to 43.

Note

- ON
Emphasizes the bright portions of images.
- OFF
Disables “White Emphasis”.

Selecting the Gamma Position

This function allows you to select the desired gamma position.

Select “Gamma Position” in the “Picture” menu on the menu screen.
→For operating the menu screen, see pages 40 to 43.
→For setting the gamma, see page 48.

Selecting the C.M.S. Color

This function allows you to select the desired color reproduction mode.

Select “Color Selected” in the “Picture” menu on the menu screen.
→For operating the menu screen, see pages 40 to 43.
→For setting the color reproduction mode, see page 50.

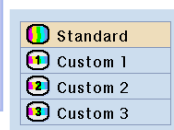
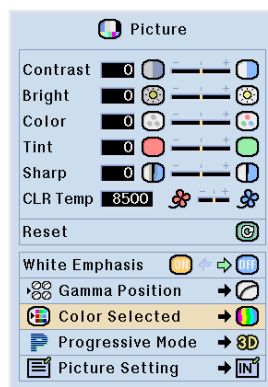
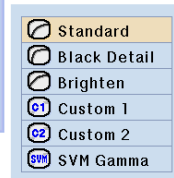
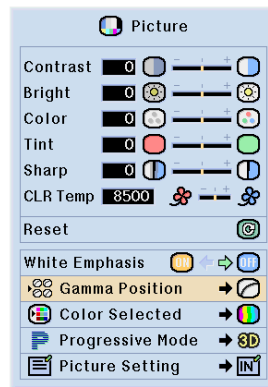
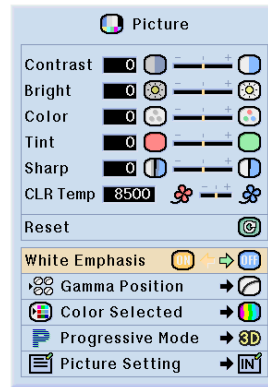

Progressive Mode

This function allows you to select the progressive display of a video signal. The progressive display projects a smoother video image.

Select “Progressive Mode” in the “Picture” menu on the menu screen.

→For operating the menu screen, see pages 40 to 43.

Note

- **2D 2D Progressive**
This function is useful to display fast-moving images such as sports and action films. This mode optimizes the image in a displayed frame.
 - **3D 3D Progressive**
This function is useful to display relatively slow-moving images such as drama and documentary more clearly. This mode optimizes the image by estimating the movement of a number of preceding and succeeding frames.
 - **Film Mode**
Reproduces the image of film source clearly. Displays the optimized image of film transformed with three-two pull down (NTSC and PAL60Hz) or two-two pull down (PAL50Hz and SECAM) enhancement to progressive mode images.
* The film source is a digital video recording with the original encoded as is at 24 frames/second. The projector can convert this film source to progressive video at 60 frames/second with NTSC and PAL60Hz or at 50 frames/second with PAL50Hz and SECAM to play back a high-definition image.
-
- When using progressive inputs, these inputs are directly displayed so that 2D Progressive, 3D Progressive and Film Mode cannot be selected. These modes can be selected in interlace signals other than 1080I.
 - In NTSC or PAL60Hz, even if the 3D Progressive mode has been set, the three-two pull down enhancement will be enabled automatically, when the film source has been entered.
 - In PAL50Hz or SECAM, the two-two pull down enhancement will be enabled only in the Film Mode, when the film source has been entered.

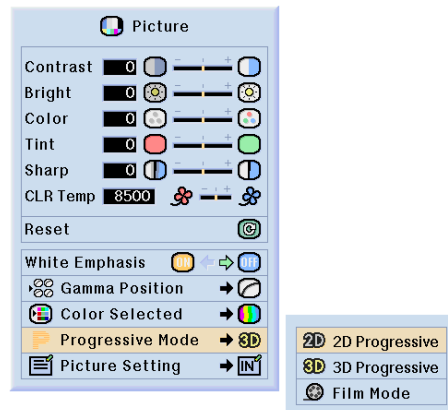

Picture Setting Function

This function stores all items set in “Picture”. Five settings can be stored separately in “Memory 1” to “Memory 5”. Each stored setting is reassigned to each input mode (INPUT 1 to INPUT 5). Even when the input mode or signal is changed, you can easily select optimal settings from the stored settings.

■ When Saving:

Select the Memory number to be saved or “INPUT # Memory” for each adjustment value in memory before setting on the “Picture” menu.

Select “Picture Setting” in the “Picture” menu on the menu screen.



→For operating the menu screen, see pages 40 to 43.

Selected item	Description
Memory 1 to Memory 5	Settings of all items in “Picture” can be stored for the respective input modes. The stored settings can be selected in any input modes.
INPUT 1 Memory to INPUT 5 Memory	Besides “Memory 1” to “Memory 5”, other settings can be stored for each input mode. “INPUT 1-5 Memory” can be selected for each input mode.

■ When Recalling Saved Contents:

When a saved memory number is selected, the contents of the “Picture” menu change to the adjustment values of the saved Memory number.

Note

- The contents of “Picture Setting” can be selected directly by pressing the  button. The contents change in the order of “Memory 1” – “Memory 5” and then “INPUT # Memory” each time  button is pressed.

■ When Changing Saved Contents:

Change the contents of the “Picture” menu after selecting the Memory number for which adjustment values are to be changed.

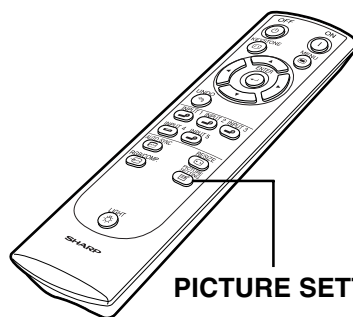
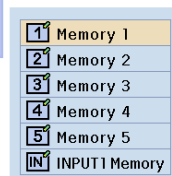
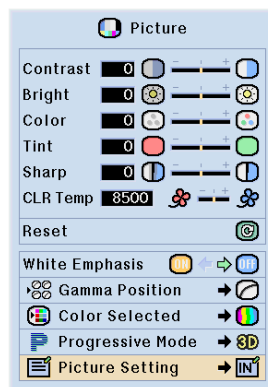

PICTURE SETTING button



Adjusting the Gamma

Use this function to select the gamma position and adjust the gamma curve for finer image adjustment.



Selecting the Gamma Position

Select "Gamma Position" in the "Gamma" menu on the menu screen.
→For operating the menu screen, see pages 40 to 43.

Selected item	Description
Standard	For Standard picture.
Black Detail	Gives greater depth to darker portions of image.
Brighten	Brightens darker portions of image.
Custom 1-2	Allows you to adjust the gamma curve for each of RGB.
SVM Gamma	Allows you to adjust gamma value using SharpVision Manager Software.

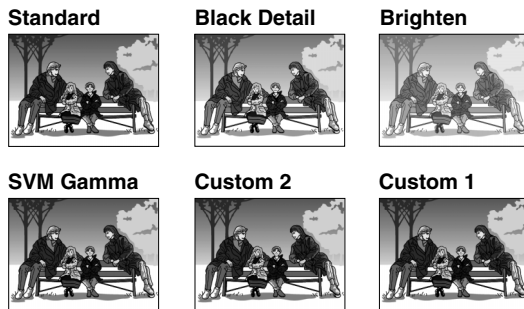
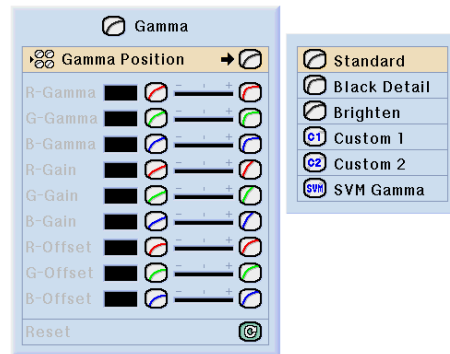

Note

- The gamma position you make the setting in this menu for can be selected in the "Gamma Position" in the "Picture" menu.
- Select "Custom 1" or "Custom 2" to make the more detailed gamma setting.
- For selecting "SVM Gamma", refer to the SharpVision Manager operation manual (supplied).

Adjusting the Gamma

Adjust the gamma curve to suit your preferences.

Select the gamma item in the “Gamma” menu on the menu screen.

→For operating the menu screen, see pages 40 to 43.

Note

- These gamma values can be adjusted only when the gamma position is set to “Custom 1” or “Custom 2”.

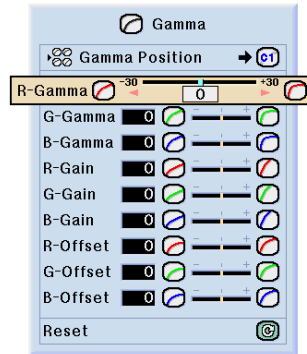

Selected Item	Description	◀ button	▶ button
Red Gamma	For adjusting the display characteristic of red color	For giving greater depth to brighter portion of image in red color.	For giving greater depth to darker portion of image in red color.
Green Gamma	For adjusting the display characteristic of green color	For giving greater depth to brighter portion of image in green color.	For giving greater depth to darker portion of image in green color.
Blue Gamma	For adjusting the display characteristic of blue color	For giving greater depth to brighter portion of image in blue color.	For giving greater depth to darker portion of image in blue color.
Red Gain	For adjusting the contrast level of red color	For less contrast in red color	For more contrast in red color
Green Gain	For adjusting the contrast level of green color	For less contrast in green color	For more contrast in green color
Blue Gain	For adjusting the contrast level of blue color	For less contrast in blue color	For more contrast in blue color
Red Offset	For adjusting the brightness level of red color	For less brightness in red color	For more brightness in red color
Green Offset	For adjusting the brightness level of green color	For less brightness in green color	For more brightness in green color
Blue Offset	For adjusting the brightness level of blue color	For less brightness in blue color	For more brightness in blue color



Color Management System (C. M. S.)

This function allows you to individually adjust the display characteristics of six colors (R: Red, Y: Yellow, G: Green, C: Cyan, B: Blue, M: Magenta) .



Selecting the Color Reproduction Mode

Select "Color Selected" in the "C.M.S." menu on the menu screen.

→For operating the menu screen, see pages 40 to 43.

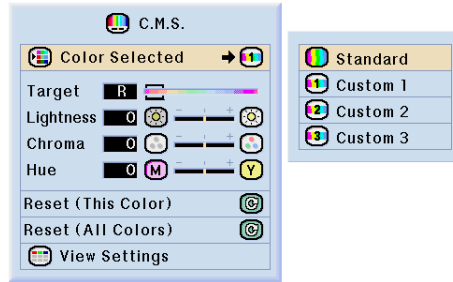

Selected item	Description
Standard	Sharp default setting
Custom 1-3	"Lightness", "Chroma" and "Hue" can be adjusted for each of the six colors.

Note

- If "Standard" is selected for "Color Selected", other items (e.g., Target) cannot be adjusted.

Selecting the Target Color

Select "Target" in the "C.M.S." menu on the menu screen.

→For operating the menu screen, see pages 40 to 43.

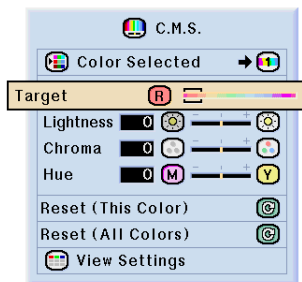

R	Red	C	Cyan
Y	Yellow	B	Blue
G	Green	M	Magenta



Setting the Brightness of the Target Color

Select “Lightness” in the “C.M.S.” menu on the menu screen.
→For operating the menu screen, see pages 40 to 43.

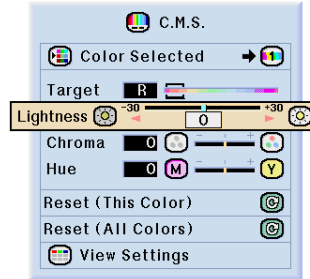

Setting the Chromatic Value of the Target Color

Select “Chroma” in the “C.M.S.” menu on the menu screen.
→For operating the menu screen, see pages 40 to 43.

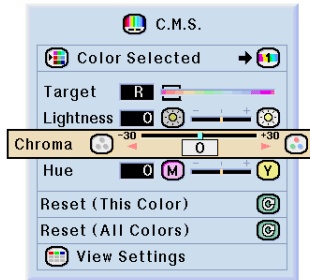

Setting the Hue of the Target Color

Select “Hue” in the “C.M.S.” menu on the menu screen.
→For operating the menu screen, see pages 40 to 43.

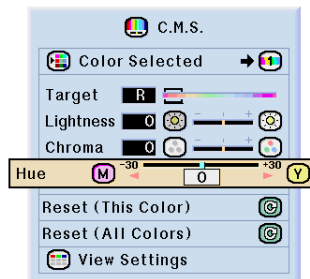



Color Management System (C.M.S.)

Resetting User-Defined Color Settings

Select "Reset (This Color)" or "Reset (All Colors)" in the "C.M.S." menu on the menu screen.

→For operating the menu screen, see pages 40 to 43.

Selected item	Description
Reset (This Color)	"Lightness", "Chroma" and "Hue" of the color selected for "Target" are reset.
Reset (All Colors)	"Lightness", "Chroma" and "Hue" of all colors are reset.

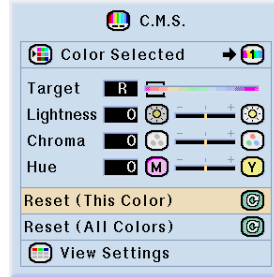

Overview of All Color Settings

Select "View Settings" in the "C.M.S." menu on the menu screen.

→For operating the menu screen, see pages 40 to 43.

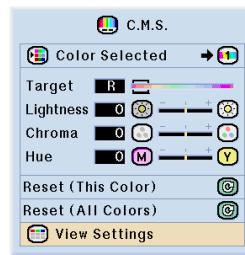

	R	Y	G	C	B	M
Lightness	0	0	0	0	0	0
Chroma	0	0	0	0	0	0
Hue	0	0	0	0	0	0

Adjusting Computer Images

Use the Fine Sync function in case of irregularities such as vertical stripes or flickering in portions of the screen.



When Auto Sync is OFF

When “Auto Sync” is “OFF”, interference such as flickering or vertical stripes may occur if displaying tilings or vertical stripes. Should this occur, adjust “Clock”, “Phase”, “H-Pos” and “V-Pos” for obtaining an optimum image.

Select “Clock”, “Phase”, “H-Pos” or “V-Pos” in the “Fine Sync” menu on the menu screen.

→For operating the menu screen, see pages 40 to 43.

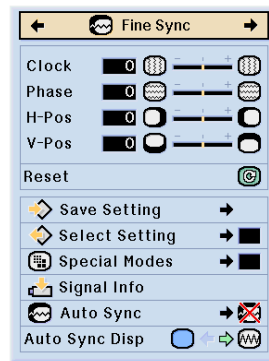

Selected Item	Description
Clock	Adjusts vertical noise.
Phase	Adjusts horizontal noise (similar to tracking on your VCR).
H-Pos	Centers the on-screen image by moving it to the left or right.
V-Pos	Centers the on-screen image by moving it up or down.

Note

- Computer image adjustments can be made easily by pressing . See page 55 for details.

Saving Adjustment Settings

This projector allows you to store up to seven adjustment settings for use with various computers.

Select “Save Setting” in the “Fine Sync” menu on the menu screen.

→For operating the menu screen, see pages 40 to 43.

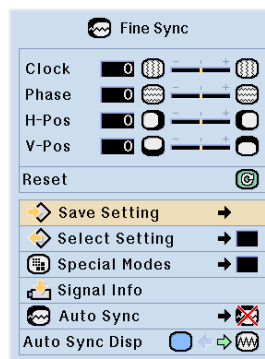

	Resolution	Vert Freq
1	1024 × 768	60 Hz
2		
3		
4		
5		
6		
7		

Selecting Adjustment Settings

Adjustment settings stored in the projector can be easily accessed.

Select “Select Setting” in the “Fine Sync” menu on the menu screen.

→For operating the menu screen, see pages 40 to 43.

Note

- If a memory position has not been set, a resolution and frequency setting will not be displayed.
- When selecting a stored adjustment setting with “Select Setting”, you can set the projector in the stored adjustments.

Special Mode Settings

Ordinarily, the type of input signal is detected and the correct resolution mode is automatically selected. However, for some signals, the optimal resolution mode in “Special Modes” on the “Fine Sync” menu screen may need to be selected to match the computer display mode.

Set the resolution by selecting “Special Modes” in the “Fine Sync” menu on the menu screen.

→For operating the menu screen, see pages 40 to 43.

Note

- Avoid displaying computer patterns which repeat every other line (horizontal stripes). (Flickering may occur, making the image hard to see.)
- When a DVD player or Digital Video is connected, select 480P as the input signal.
- See “Checking the Input Signal” below for information on the currently selected input signal.

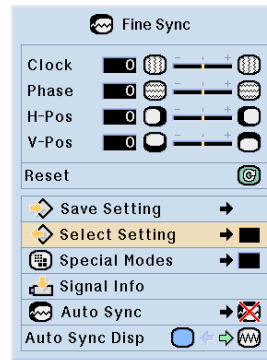

	Resolution	Vert Freq
1	1024 × 768	75 Hz
2		
3		
4		
5		
6		
7		

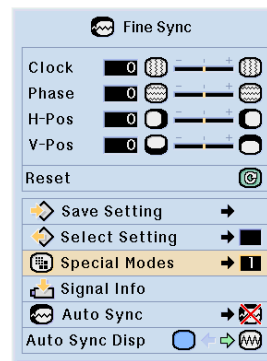

	Resolution
1	640 × 480
2	720 × 480
3	480p
4	
5	
6	
7	



Adjusting Computer Images

Checking the Input Signal

This function allows you to check the current input signal information.

Select “Signal Info” in the “Fine Sync” menu on the menu screen.

→For operating the menu screen, see pages 40 to 43.

Note

- The projector will display the number of scanned lines available from audio-visual equipment such as a DVD player or Digital Video.

Auto Sync Adjustment

Used to automatically adjust a computer image.

Select “Auto Sync” in the “Fine Sync” menu on the menu screen.

→For operating the menu screen, see pages 40 to 43.

Note

When setting to “Normal” or “High Speed”:

- Auto Sync adjustment will occur when the projector is turned on or when the inputs are switched, when connected to a computer.

Manual adjustments should be performed:

- When the optimum image cannot be achieved with Auto Sync adjustment. See page 53.
- Auto Sync adjustment may take some time to complete, depending on the image of the computer connected to the projector.
- When setting “Auto Sync” to “OFF” or “High Speed”, and if ^{AUTO SYNC} is pressed Auto Sync will be executed in “High Speed” mode. If the button is pressed again within one minute, Auto Sync will be executed in “Normal” mode.

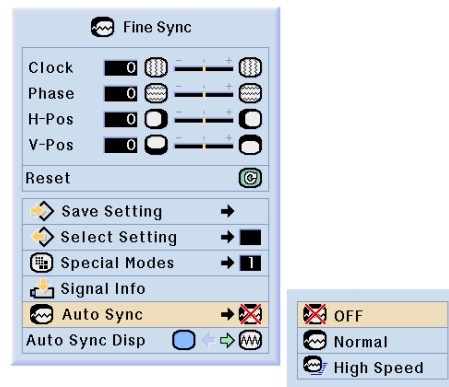
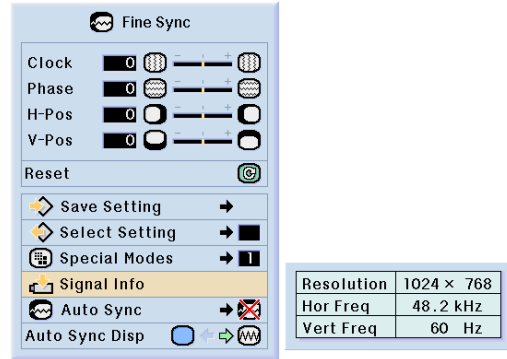

Screen display during Auto Sync

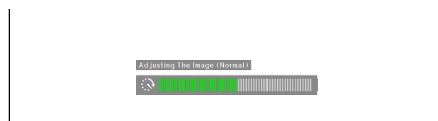

AUTO SYNC button

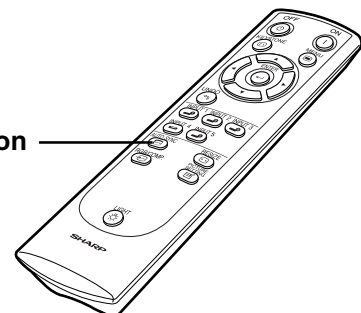





Auto Sync Display Function

Used to set the screen displayed during Auto Sync.

Select “Auto Sync Disp” in the “Fine Sync” menu on the menu screen.

→For operating the menu screen, see pages 40 to 43.

Selected item	Description
	The image set as a background image is projected.
	The computer image being adjusted is displayed.

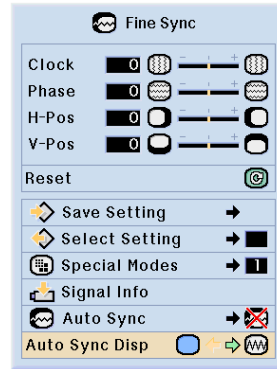



Easy to Use Functions

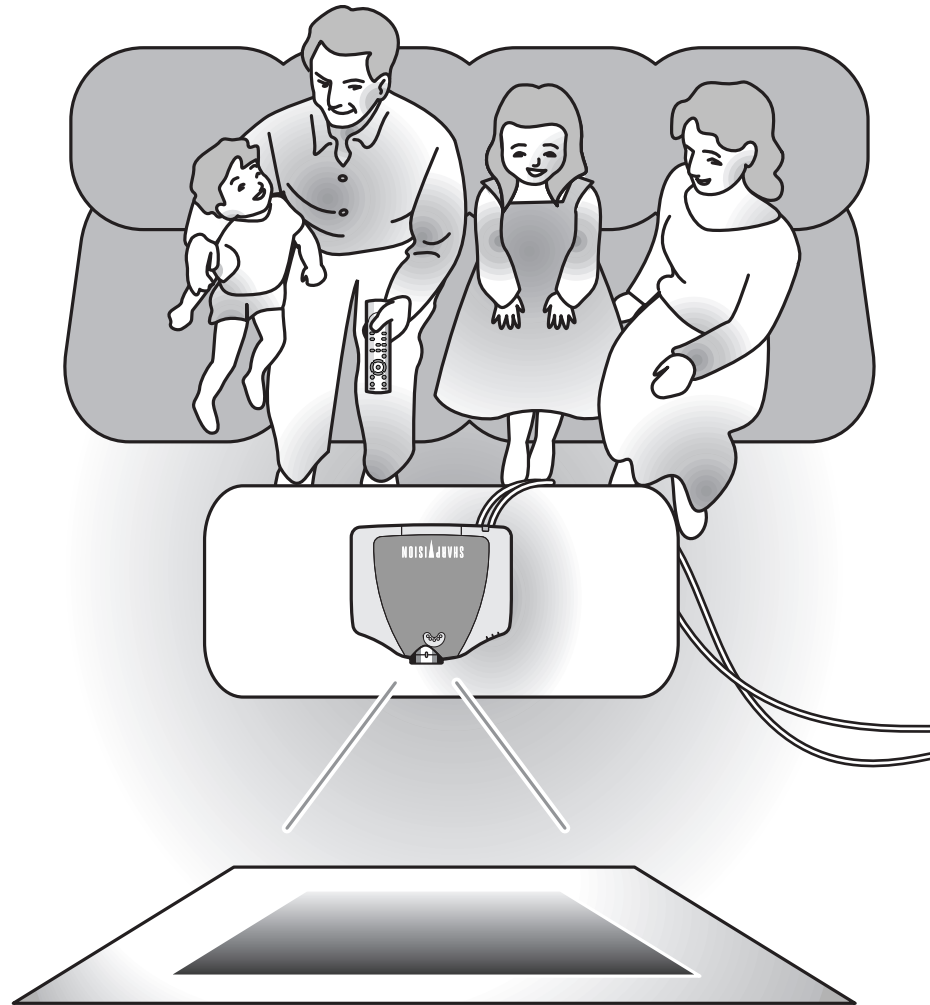

Easy to Use Functions



Selecting the Picture Display Mode

This function allows you to modify or customize the picture display mode to enhance the input image. Depending on the input signal, you can choose “NORMAL”, “FULL”, “DOT BY DOT”, “BORDER”, “STRETCH” or “SMART STRETCH” image.

Switching the Picture Display Using Different Input Signals

Press .

- Each time  is pressed, the display changes as shown on pages 59 and 60.



Info

- In the Dot by Dot Mode, images are displayed in the original resolution, therefore they will not be enlarged.
- To return to the standard image, press  while “RESIZE” is displayed on the screen.

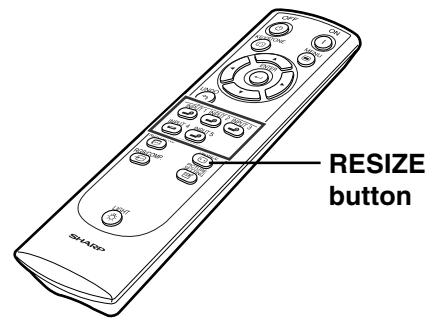

Screen display of the picture display mode





VIDEO

		SIDE BAR	SMART STRETCH	CINEMA ZOOM	STRETCH	DOT BY DOT
For 4:3 aspect ratio	480I 480P 576I 576P NTSC PAL SECAM	960 × 720	1280 × 720	1280 × 720	1280 × 720	-
	480P	960 × 720	1280 × 720	1280 × 720	1280 × 720	-
For 16:9 aspect ratio	720P	-	-	-	1280 × 720	1280 × 720
	1080I	-	-	-	1280 × 720	-

- "STRETCH" is fixed when 720P, or 1080I signals are entered.
- * The Digital Shift function can be used with these images.

Input Signal	Output screen image				
	SIDE BAR	SMART STRETCH	CINEMA ZOOM	STRETCH	DOT BY DOT
 For 4:3 aspect ratio					
480I 480P 576I 576P NTSC PAL SECAM Letter box image					
 With squeeze					
540P 1080I For 16:9 aspect ratio					
720P 					

Easy to Use Functions



COMPUTER

		NORMAL	DOT BY DOT
For 4:3 aspect ratio	SVGA (800 × 600)	960 × 720	800 × 600
	XGA (1024 × 768)	960 × 720	1024 × 720
	SXGA (1280 × 960)	960 × 720	1280 × 720
For without 4:3 aspect ratio	SXGA (1280 × 1024)	900 × 720	1280 × 720

• “NORMAL” is fixed when XGA (1024 × 768) signals are entered.

	Input Signal	Output screen image	
		NORMAL	DOT BY DOT
VGA	 For 4:3 aspect ratio (640 × 480)		
SVGA	 For 4:3 aspect ratio (800 × 600)		
XGA	 For 4:3 aspect ratio (1024 × 768)		
SXGA	 For 5:4 aspect ratio (1280 × 1024)		





Switchable High Contrast/High Brightness Mode

This function controls the quantity of the projected light and the contrast of the image. It can be operated using the HIGH CONTRAST/HIGH BRIGHTNESS MODE button on the projector. Set "NORMAL" when the projector is used in a relatively bright room.

Operating the Theater Mode Function

Press the HIGH CONTRAST/HIGH BRIGHTNESS MODE button to select the "HIGH CONTRAST MODE" or "HIGH BRIGHTNESS MODE".

Selected mode	Description
HIGH CONTRAST MODE 	This mode is recommended for dark environments.
HIGH BRIGHTNESS MODE 	This mode is recommended for bright environments.

Note

- When selecting "HIGH CONTRAST MODE", the fan noise increases.
- Even when selecting "HIGH CONTRAST MODE", the fan noise may increase if internal temperature rises enough to activate the cooling function.

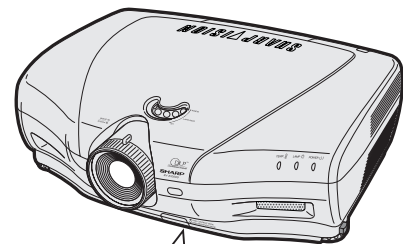

**HIGH CONTRAST/
HIGH BRIGHTNESS MODE
button**

-  HIGH CONTRAST MODE
-  HIGH BRIGHTNESS MODE



Digital Shift Function

For easier viewing, this function shifts the entire image projected on the screen up or down when projecting 16:9 images from DVD players and DTV* decoders.

* DTV is the umbrella term used to describe the new digital television system in the United States.



Adjusting the Digital Shift

Select "Digital Shift" in the "Options" menu on the menu screen.

→For operating the menu screen, see pages 40 to 43.

Note

- The Digital Shift Function works with the SMART STRETCH and CINEMA ZOOM screen. For details, see pages 59 and 60.

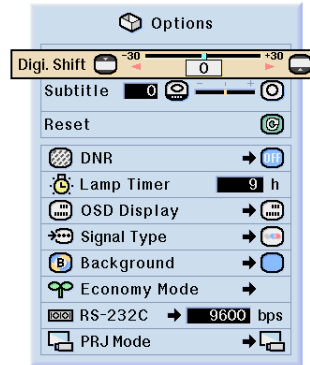

Subtitle Setting

With this function, you can adjust the vertical size of the display to allow for subtitles.



Adjusting the Vertical Size of the Display

Select "Subtitle" in the "Options" menu on the menu screen.

→For operating the menu screen, see pages 40 to 43.

Note

- When changing the screen with the Subtitle setting, not only the bottom of the screen rises, but also the upper part is changed to a certain point.
- The subtitle setting can be adjusted more effectively with the Digital Shift function.
- The subtitle setting can be made only with the SMART STRETCH and CINEMA ZOOM screen. For details, see pages 59 and 60.

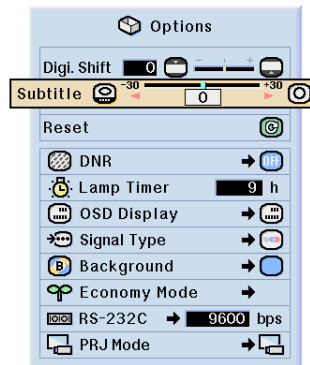



Video Digital Noise Reduction (DNR) System

Digital Noise Reduction (DNR) provides high quality images with minimal dot crawl and cross color noise.



Reducing Image Noise

Select "DNR" in the "Options" menu on the menu screen.

→For operating the menu screen, see pages 40 to 43.

Note

- Set a level so as to view a clearer picture.
- Make sure to set DNR to "OFF" in the following cases:
- When the image is blurry.
 - When the contours and colors of moving images drag.
 - When TV broadcasts with weak signals are projected.

Info

- This function is available with INPUT 1, 2 (480I, 480P, 580I and 580P signals) and INPUT 3, 4 (all signals).

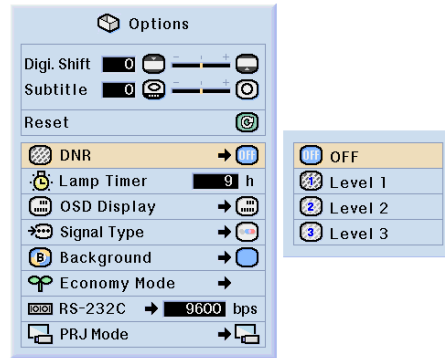

Setting On-screen Display

This function allows you to turn on or off the on-screen messages. When setting "Level A" or "Level B" in "OSD Display", the input mode display (e.g. INPUT 1) will not appear, even if the INPUT button is pressed.

Turning Off the On-screen Display

Select "OSD Display" in the "Options" menu on the menu screen.

→For operating the menu screen, see pages 40 to 43.

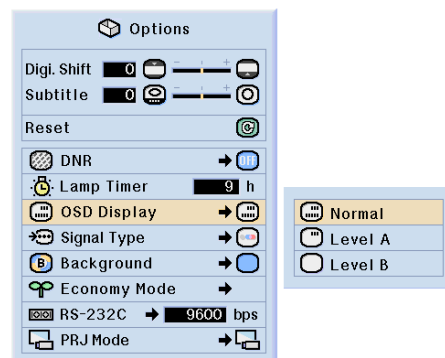

Selected Item	Description
Normal	All On-screen Displays are displayed.
Level A	Input and Auto Sync are not displayed.
Level B	All On-screen Displays are not displayed. (except for Menu, On-screen Displays displayed when the KEYSTONE button is pressed, and warning displays (Power off/Temp./Change The Lamp., etc.))

Selecting the Signal Type



This function allows you to select the input signal type RGB or Component for INPUT 1 and 2, or Digital PC RGB, Digital PC Component, Digital Video RGB, Digital Video Component, Analog RGB or Analog Component for INPUT 5.

Select “Signal Type” in the “Options” menu on the menu screen.







→For operating the menu screen, see pages 40 to 43.

Note

For INPUT 1 and INPUT 2

 RGB	Set when RGB signals are received from video equipment.
 Component	Set when analog component signals are received from video equipment.

For INPUT 5

 D. PC RGB	Set when digital PC RGB signals are received from the computer.
 D. PC Comp.	Set when digital PC component signals are received from the computer.
 D. Video RGB	Set when digital video RGB signals are received from video equipment.
 D. Video Comp.	Set when digital video component signals are received from video equipment.
 A. RGB	Set when analog RGB signals are received.
 A. Comp.	Set when analog component signals are received.

For INPUT 1 and INPUT 2

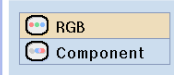
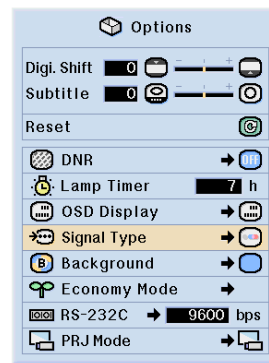

For INPUT 5

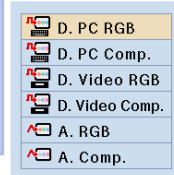
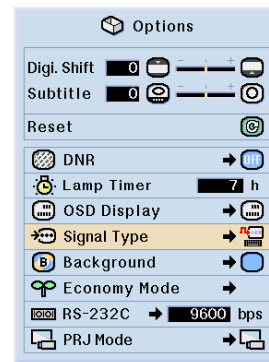



Setting the Video System

The video input system mode is preset to “Auto”; however, a clear picture from the connected audio-visual equipment may not be received, depending on the video signal difference. In that case, switch the video signal.



Setting the Video System

Select “Video System” in the “Options” menu on the menu screen.
→For operating the menu screen, see pages 40 to 43.

Note

- The video signal can only be set in INPUT 3 or INPUT 4 mode.
- In “Auto”, images are displayed in PAL even if PAL-N or PAL-M input signals are received.

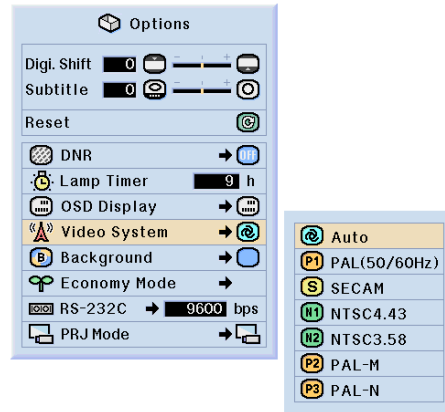

PAL	When connected to PAL video equipment.
SECAM	When connected to SECAM video equipment.
NTSC4.43	When reproducing NTSC signals in PAL video equipment.
NTSC3.58	When connected to NTSC video equipment.

Easy to Use Functions

Setting a Background Image

This function allows you to select the image displayed when no signal is being sent to the projector.



Selecting a Background Image

Select “Background” in the “Options” menu on the menu screen.
 →For operating the menu screen, see pages 40 to 43.

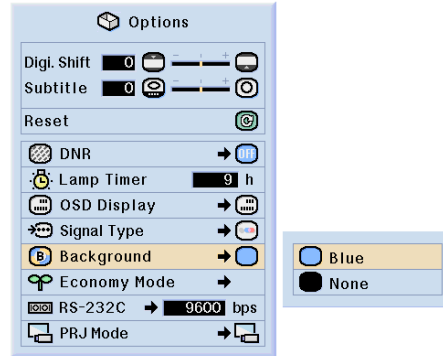

Selected Item	Description
<input checked="" type="radio"/> Blue	Blue screen
<input type="radio"/> None	Black screen *

* If the input signal has interference, the screen will be displayed with the interference.

Selecting the Economy Mode

These functions allow you to reduce the power consumption of the projector.



Setting the Power Save

Select “Power Save” in “Economy Mode” under the “Options” menu on the menu screen.

→For operating the menu screen, see pages 40 to 43.

Note

- Although noise is reduced when “Power Save” is set to “ON”, brightness decreases by 20%.
- “Power Save” mode is factory preset to “OFF”.
- “Power Save” is switched on and off by pressing

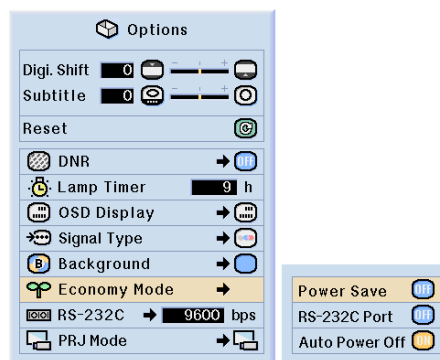

Status	Brightness	Power consumption
ON (Low power mode)	80%	220 W
OFF (Standard mode)	100%	270 W

RS-232C Off Function

This projector consumes power when using a computer connected to the RS-232C terminal. When not using these terminals, “RS-232C Port” can be set to “OFF” to reduce standby power consumption.

Select “RS-232C Port” in “Economy Mode” under the “Options” menu on the menu screen.

→For operating the menu screen, see pages 40 to 43.

ON	RS-232C connection is set to “ON”. The RS-232C is operating at all times (to accept communications).
OFF	RS-232C connection is set to “OFF”. RS-232C does not operate when the power supply is in standby.

Note

- Set “RS-232 Port” to “ON” when using the SharpVision Manager Software.
- “RS-232S Port” is switched on and off by pressing

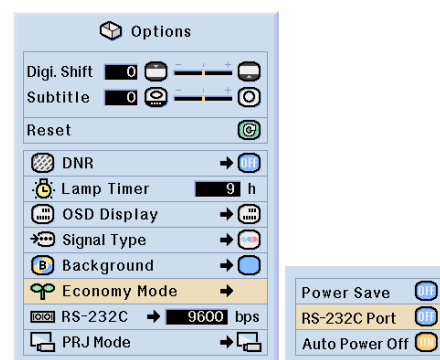

Easy to Use Functions

Selecting the Economy Mode

Automatic Power Off Function

When no input signal is detected for more than 15 minutes, the projector will automatically turn off if set to "ON".

The Auto Power Off function will be disabled when it is set to "OFF".

Select "Auto Power Off" in "Economy Mode" under the "Options" menu on the menu screen.

→For operating the menu screen, see pages 40 to 43.

Note

- When the Auto Power Off function is set to "ON", 5 minutes before the power turns off, the message "Power OFF in X min." will appear on the screen to indicate the remaining minutes.
- "Auto Power Off" is switched on and off by pressing .

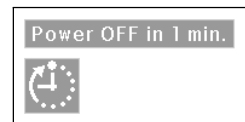
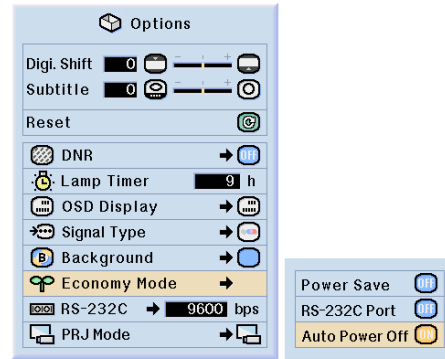

Selecting the Transmission Speed (RS-232C)

This menu allows you to adjust the transmission speed of the RS-232C connection by selecting the baud rate.



Selecting the Transmission Speed (RS-232C)

Select "RS-232C" in the "Options" menu on the menu screen.

→For operating the menu screen, see pages 40 to 43.

Note

- Make sure that both the projector and computer are set for the same baud rate. Refer to the computer's operation manual for instructions for setting the computer's baud rate.

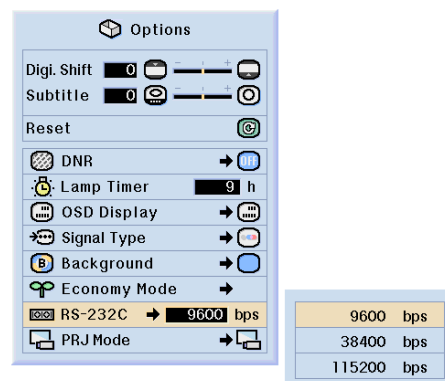

Reversing/Inverting Projected Images

This projector is equipped with a reverse/invert image function that allows you to reverse or invert the projected image for various applications.



Setting the Projection Mode

Select "PRJ Mode" in the "Options" menu on the menu screen.
 → For operating the menu screen, see pages 40 to 43.

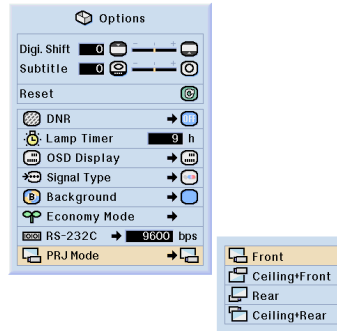

Selected Item	Description
Front	Normal image
Ceiling + Front	Inverted image
Rear	Reversed image
Ceiling + Rear	Reversed and inverted image

Note

- This function is used for the reversed image and ceiling-mount setups. See page 30 for these setups.

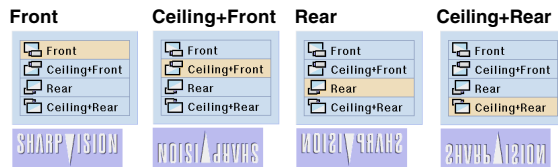

Easy to Use Functions



Displaying the Adjustment Settings

This function can be used to display all the adjusted settings as a list on the screen.



Overview of All Menu Settings

Select the "Status" menu on the menu screen and press .
→For operating the menu screen, see pages 40 to 43.

Picture	Fine Sync	Options	English
Contrast 0	Clock	Digt. Shift	Language
Bright 0	Phase	Subtitle	Smart Stre
Color 0	H-Pos	DNR	Resize
Finl 0	V-Pos	Lamp Timer 9h	Auto Power Off
Sharp	Select Setting	OSS Display	RS-232C 9600bps
CLR Temp 8500	Special Modes	Signal Type	PIR Mode
White Emphasis	Auto Sync	Background	Progressive Mode
Gamma Position	Auto Sync Disp	Power Save	Picture Setting
Color Selected		RS-232C Port	TEST2926



Appendix

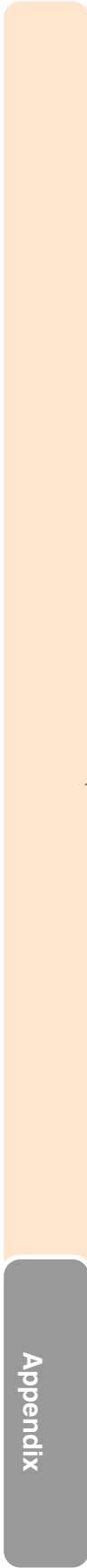



Maintenance

Cleaning the projector

- Be sure to unplug the power cord before cleaning the projector.
- The cabinet as well as the operation panel is made of plastic. Avoid using benzene or thinner, as these can damage the finish on the cabinet.
- Do not use volatile agents such as insecticides on the projector.
Do not attach rubber or plastic items on the projector for long time.
The effects of some of the agents in the plastic may cause damage to the quality or finish of the projector.

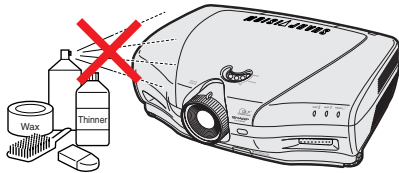

- Wipe off dirt gently with a soft flannel cloth.

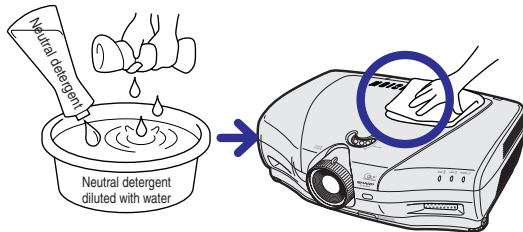

- When the dirt is hard to remove, soak a cloth in a neutral detergent diluted with water, wring the cloth well and then wipe the projector. Strong cleaning detergents may discolor, warp or damage the coating on the projector. Make sure to test on a small, inconspicuous area on the projector before using.

Cleaning the lens

- Use a commercially available blower or lens cleaning paper (for glasses and camera lenses) for cleaning the lens. Do not use any liquid type cleaning agents, as they may wear off the coating film on the surface of the lens.
- As the surface of the lens can easily get damaged, be sure not to scrape or hit the lens.

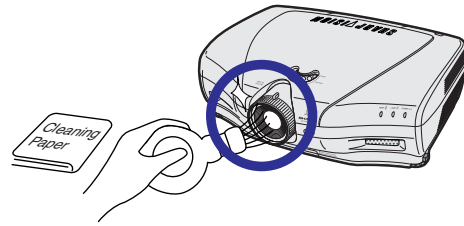

Cleaning the exhaust and intake vents

- Use a vacuum cleaner to clean dust from the exhaust vent and the intake vent.

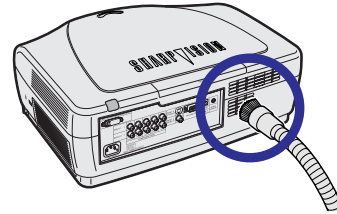



Cleaning the Ventilative Holes

- This projector is equipped with ventilative holes to ensure the optimal operating condition of the projector.
- Periodically clean the ventilative hole by vacuuming it off with a vacuum cleaner.
- The ventilative holes should be cleaned every 100 hours of use. Clean the ventilative holes more often when the projector is used in a dirty or smoky location.

Side and Rear view

Bottom view

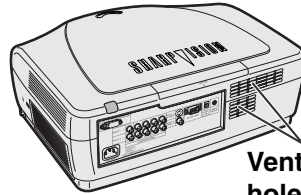

Ventilative holes

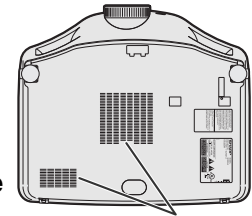

Ventilative holes

Cleaning the Ventilative Holes

1 Turn off the power and disconnect the power cord.

- Press . Wait until the cooling fan stops.

Power (OFF) button

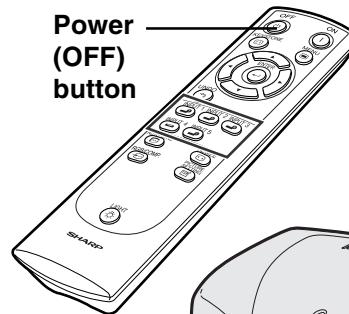

Power (OFF) button

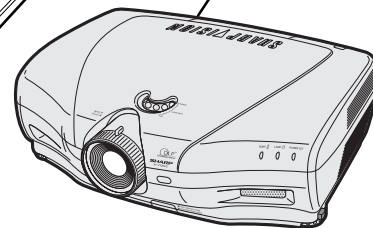

2 Unplug the Power Cord.

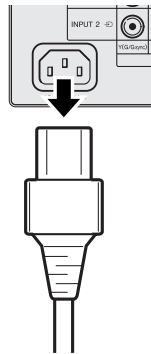

3 Clean the dust off by putting the cleaner hose on the intake ventilative holes.



Cleaner hose

Cleaner hose



Maintenance Indicators

- The warning lights on the projector indicate problems inside the projector.
- If a problem occurs, either the temperature warning indicator or the lamp replacement indicator will illuminate red, and the power will turn off. After the power has been turned off, follow the procedures given below.

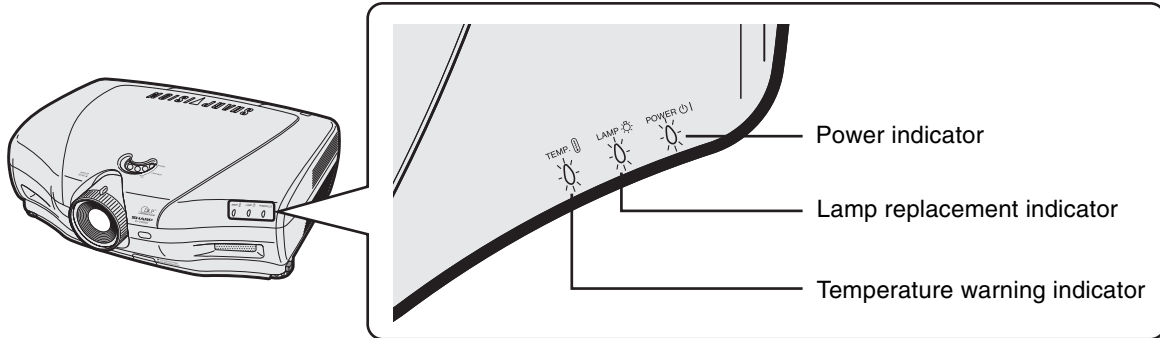



About the temperature warning indicator

If the temperature inside the projector increases, due to blockage of the air vents, or the setting location, "TEMP." will blink in the lower left corner of the picture. If the temperature keeps on rising, the lamp will turn off and the temperature warning indicator will blink, the cooling fan will run for further 90 seconds, then the power will be shut off. After "TEMP." appears, be sure to perform the following measures.



About the lamp replacement indicator

- When the lamp exceeds 1,900 cumulative hours of use,  will be displayed on the screen in yellow. When the cumulative hours of use reach 2,000,  will change to red, the lamp will automatically turn off and then the projector as well. At this time, the LAMP REPLACEMENT indicator will illuminate in red.
- If you try to turn on the projector a fourth time without replacing the lamp, the projector will not turn on.



Maintenance indicator		Condition	Problem	Possible Solution
Temperature warning indicator	Normal	The internal temperature is abnormally high.	<ul style="list-style-type: none"> • Blocked air intake • Cooling fan breakdown • Internal circuit failure • Clogged air intake 	<ul style="list-style-type: none"> • Relocate the projector to an area with proper ventilation. • Take the projector to your nearest Authorized SharpVision Service Center or Dealer for repair. • Clean the ventilative holes according to the procedure on page 73.
	Abnormal			
Lamp replacement indicator	Blue on Blue blinks when the lamp is active.	The lamp does not illuminate.	<ul style="list-style-type: none"> • Burnt-out lamp • Lamp circuit failure 	<ul style="list-style-type: none"> • Carefully replace the lamp. (See page 77) • Take the projector to your nearest Authorized SharpVision Service Center or Dealer for repair. • Please exercise care when replacing the lamp.
Power indicator	Blue on/ Red on	Red blinks	The power indicator blinks in red when the projector is on.	<ul style="list-style-type: none"> • The exhaust vent cover is open. • Securely install the cover. • If the power indicator blinks even when the exhaust vent cover is securely installed, contact your nearest Authorized SharpVision Service Center or Dealer for advice.





Maintenance Indicators

Info

- If the temperature warning indicator illuminates, and the power turns off, follow the above possible solutions and then wait until the projector has cooled down completely before plugging in the power cord and turning the power back on. (At least 5 minutes.)
- If the power is turned off and then turned on again, as during a brief test, the lamp replacement indicator may be triggered, preventing the power from going on. Should this occur, take the power cord out of the wall outlet and plug it back in again.
- If you want to clean the air vents during projector operation, be sure to first press . Make sure the power has turned off and the cooling fan has stopped, then clean the vents.
- Do not unplug the power cord after the power has been turned off and while the cooling fan is running. The cooling fan runs for about 90 seconds.



Regarding the Lamp

Lamp

- It is recommended that the lamp (sold separately) be replaced after approximately 1,900 cumulative hours of use or when you notice a significant deterioration in the picture and color quality. The number of hours the lamp has been used can be checked with “Lamp Timer” in the “Options” menu on the menu screen.
- For lamp replacement, please consult your nearest Authorized SharpVision Service Center or Dealer.
- The actual lamp service life may be less than 1900 hours depending on the environment in which the projector is used.

IMPORTANT NOTE TO U.S. CUSTOMERS:

The lamp included with this projector is backed by a 90-day parts and labor limited warranty. All service of this projector under warranty, including lamp replacement, must be obtained through an Authorized SharpVision Service Center or Dealer. For the name of the nearest Authorized SharpVision Service Center or Dealer, please call toll-free: 1-877-DTV-SHARP (1-877-388-7427). U.S.A. ONLY

Caution Concerning the Lamp

- This projector utilizes a pressurized mercury lamp. A loud sound may indicate lamp failure. Lamp failure can be attributed to numerous sources such as: excessive shock, improper cooling, surface scratches or deterioration of the lamp due to a lapse of usage time. The period of time up to failure largely varies depending on the individual lamp and/or the condition and the frequency of use. It is important to note that failure can often result in the bulb cracking.
- When the lamp replacement indicator and on-screen display icon are illuminated or flash, it is recommended that the lamp be replaced with a new one immediately, even if the lamp appears to be operating normally.
- Should the lamp break, the glass particles may spread inside the lamp cage or gas contained in the lamp may be vented into the room from the exhaust vent. Because the gas in this lamp includes mercury, ventilate the room well if the lamp breaks and avoid all exposure to the released gas. In case of exposure to the gas, consult with a doctor as soon as possible.
- Should the lamp break, there is also a possibility that glass particles may spread inside of the projector. In such a case, it is recommended you contact your nearest Authorized SharpVision Service Center or Dealer to remove the damaged lamp and assure safe operation.

Replacing the Lamp

Caution

- Do not remove the lamp unit immediately after operation of the projector. The lamp will be hot and touching it can lead to burn or injury.
- Wait at least one hour after the power cord is disconnected to allow the surface of the lamp unit to fully cool before removing the lamp unit.
- If the new lamp does not light after replacement, take your projector to the nearest Authorized SharpVision Service Center or Dealer for repair. Purchase a replacement lamp unit of type BQC-XVZ100001 from your nearest Authorized SharpVision Service Center or Dealer. Then carefully change the lamp by following the instructions described in this section. If you wish, you may have the lamp replaced at your nearest Authorized SharpVision Service Center or Dealer.

Regarding the Lamp

Removing and Installing the Lamp Unit

Info

- Be sure to remove the lamp unit by the handle. Be sure not to touch the glass surface of the lamp unit or the inside of the projector.
- To avoid injury to yourself and damage to the lamp, be sure to carefully follow the steps below.
- Do not loosen other screws except for the lamp unit cover and lamp unit. (Only the silver screws are loosened).
- Please refer to the installation manual included with the lamp unit.

1 Press on the projector or on the remote control to turn off the power.

- Wait until the cooling fan stops.

Warning!

- Do not remove the lamp unit from the projector right after use. The lamp will be very hot and may cause burn or injury.

2 Disconnect the power cord.

- Unplug the power cord from the AC socket.
- Leave the lamp until it has fully cooled down (about 1 hour).

3 Remove the lamp unit cover.

- Loosen the user service screw that secures the lamp unit cover. Then open the cover in the direction of the arrow.

Lamp unit

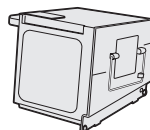

BQC-XVZ100001

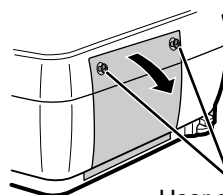
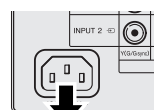
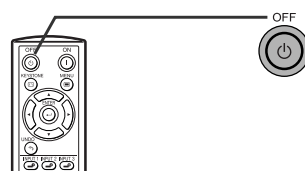
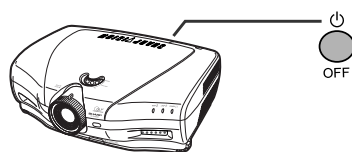

User service screws



4 Remove the lamp unit.

- Loosen the securing screws from the lamp unit. Hold the lamp unit by the handle and pull it in the direction of the arrow.

5 Insert the new lamp unit.

- Press the lamp unit firmly into the lamp unit compartment. Fasten the securing screws.

6 Attach the lamp unit cover.

- Close the lamp unit cover in the direction of the arrow (to the close mark) on the side of the projector. Then tighten the user service screw.

Info

- If the lamp unit and lamp cover are not correctly installed, the power will not turn on, even if the power cord is connected to the projector.

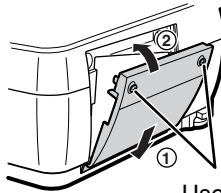
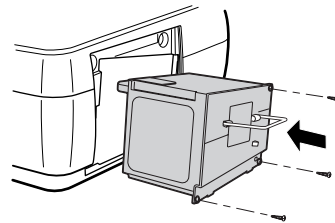
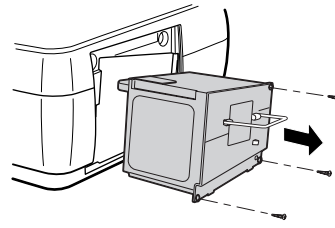

User service screws





Resetting the Lamp Timer

Reset the lamp timer after replacing the lamp.

1 Connect the power cord.

- Plug the power cord into the AC socket of the projector.

2 Reset the lamp timer.

- While holding down ,  and  on the projector, press  on the projector.
- "LAMP 0000H" is displayed, indicating that the lamp timer is reset.

Info

- Make sure to reset the lamp timer only when replacing the lamp. If you reset the lamp timer and continue to use the same lamp, this may cause the lamp to become damaged or explode.

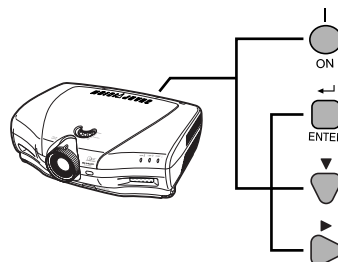
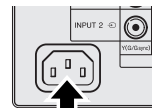

Connecting Pin Assignments

DVI-I (INPUT 5 / DIGITAL INPUT) port : 29 pin connector

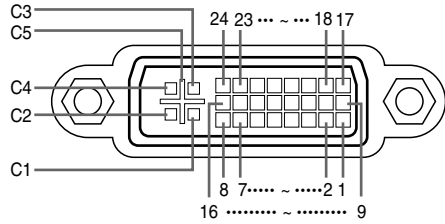

• DVI Digital INPUT

Pin No.	Signal	Pin No.	Signal
1	T.M.D.S data 2-	16	Hot plug detection
2	T.M.D.S data 2+	17	T.M.D.S data 0-
3	T.M.D.S data 2 shield	18	T.M.D.S data 0+
4	Not connected	19	T.M.D.S data 0 shield
5	Not connected	20	Not connected
6	DDC clock	21	Not connected
7	DDC data	22	T.M.D.S clock shield
8	Not connected	23	T.M.D.S clock+
9	T.M.D.S data 1-	24	T.M.D.S clock-
10	T.M.D.S data 1+	C1	Not connected
11	T.M.D.S data 1 shield	C2	Not connected
12	Not connected	C3	Not connected
13	Not connected	C4	Not connected
14	+5V power	C5	Ground
15	Ground		

• DVI Analog RGB Input

Pin No.	Signal	Pin No.	Signal
1	Not connected	16	Hot plug detection
2	Not connected	17	Not connected
3	Not connected	18	Not connected
4	Not connected	19	Not connected
5	Not connected	20	Not connected
6	Not connected	21	Not connected
7	Not connected	22	Not connected
8	Vertical sync	23	Not connected
9	Not connected	24	Not connected
10	Not connected	C1	Analog input Red
11	Not connected	C2	Analog input Green
12	Not connected	C3	Analog input Blue
13	Not connected	C4	Horizontal sync
14	+5V power	C5	Ground
15	Ground		

• DVI Analog Component Input

Pin No.	Signal	Pin No.	Signal
1	Not connected	16	Not connected
2	Not connected	17	Not connected
3	Not connected	18	Not connected
4	Not connected	19	Not connected
5	Not connected	20	Not connected
6	Not connected	21	Not connected
7	Not connected	22	Not connected
8	Not connected	23	Not connected
9	Not connected	24	Not connected
10	Not connected	C1	Analog input Pr/Cr
11	Not connected	C2	Analog input Y
12	Not connected	C3	Analog input Pb/Cb
13	Not connected	C4	Not connected
14	Not connected	C5	Ground
15	Ground		

RS-232C Port: 9-pin D-sub male connector of the DIN-D-sub RS-232C cable

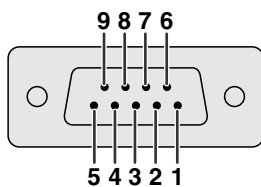

Pin No.	Signal	Name	I/O	Reference
1				Not connected
2	RD	Receive Data	Input	Connected to internal circuit
3	SD	Send Data	Output	Connected to internal circuit
4		Reserved		Connected to internal circuit
5	SG	Signal Ground		Connected to internal circuit
6		Reserved		Connected to internal circuit
7		Reserved		Connected to internal circuit
8		Reserved		Connected to internal circuit
9				Not connected

(RS-232C) Specifications and Command Settings

PC control

A computer can be used to control the projector by connecting an RS-232C cable (null modem, cross type, commercially available) to the projector. (See page 23 for connection.)

Communication conditions

Set the serial port settings of the computer to match that of the table.

Signal format: Conforms to RS-232C standard.

Baud rate*: 9,600 bps / 384,00bps / 1152,00bps

Data length: 8 bits

Parity bit: None

Stop bit: 1 bit

Flow control: None

*Use the same settings for the projector and computer.

Basic format

Commands from the computer are sent in the following order: command, parameter, and return code. After the projector processes the command from the computer, it sends a response code to the computer.

Command format

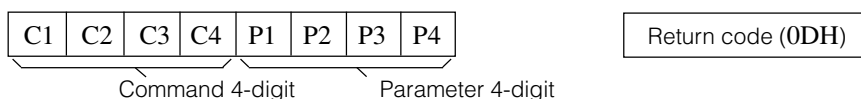

Response code format

Normal response

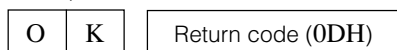

Problem response (communication error or incorrect command)



Info

- When more than one code is being sent, send each command only after the response code for the previous command from the projector is verified.
- In the case of transmitting commands during standby, it takes a maximum of 30 seconds until the response code is received.
- When the power is turned on during standby with the "POWER ON" command, wait for at least 30 seconds after the power has been turned on, and then transmit the next command.

Note

- When using the computer control function of the projector, the projector's operating status cannot be read by the computer. Therefore, confirm the status by transmitting the display commands for each adjustment menu and checking the status with the on-screen display. If the projector receives a command other than a menu display command, it will execute the command without displaying the on-screen display.

Commands

Example:

- When "BRIGHT" of INPUT 1 image adjustment is set to -10.

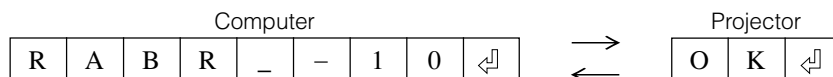

(RS-232C) Specifications and Command Settings

	CONTROL CONTENTS	COMMAND	PARAMETER	RETURN
	POWER ON	P O W R	_ _ _ 1	OK OR ERR
	POWER OFF	P O W R	_ _ _ 0	OK OR ERR
	KEystone (-127 ~ +127)	K E Y S	* * * *	OK OR ERR
	V-SIZE (-30 ~ +30)	V S I Z	_ _ * *	OK OR ERR
	INPUT 1	I R G B	_ _ _ 1	OK OR ERR
	INPUT 2	I R G B	_ _ _ 2	OK OR ERR
	INPUT 3	I V E D	_ _ _ 2	OK OR ERR
	INPUT 4	I V E D	_ _ _ 1	OK OR ERR
	INPUT 5	I R G B	_ _ _ 3	OK OR ERR
	INPUT CHECK	I C H K	_ _ _ 0	OK OR ERR
	AUTO SYNC START	A D J S	_ _ _ 1	OK OR ERR
BUTTONS & REMOTE CONTROL KEY	INPUT 1 (COMPONENT 1) RESIZE : SIDE BAR	R A S R	_ _ _ 3	OK OR ERR
	INPUT 1 (COMPONENT 1) RESIZE : SMART STRETCH	R A S R	_ _ _ 4	OK OR ERR
	INPUT 1 (COMPONENT 1) RESIZE : CINEMA ZOOM	R A S R	_ _ _ 1	OK OR ERR
	INPUT 1 (COMPONENT 1) RESIZE : STRETCH	R A S R	_ _ _ 2	OK OR ERR
	INPUT 2 (COMPONENT 2) RESIZE : SIDE BAR	R B S R	_ _ _ 3	OK OR ERR
	INPUT 2 (COMPONENT 2) RESIZE : SMART STRETCH	R B S R	_ _ _ 4	OK OR ERR
	INPUT 2 (COMPONENT 2) RESIZE : CINEMA ZOOM	R B S R	_ _ _ 1	OK OR ERR
	INPUT 2 (COMPONENT 2) RESIZE : STRETCH	R B S R	_ _ _ 2	OK OR ERR
	INPUT 3 (S-VIDEO) RESIZE : SIDE BAR	R B S V	_ _ _ 3	OK OR ERR
	INPUT 3 (S-VIDEO) RESIZE : SMART STRETCH	R B S V	_ _ _ 4	OK OR ERR
	INPUT 3 (S-VIDEO) RESIZE : CINEMA ZOOM	R B S V	_ _ _ 1	OK OR ERR
	INPUT 3 (S-VIDEO) RESIZE : STRETCH	R B S V	_ _ _ 2	OK OR ERR
	INPUT 4 (VIDEO) RESIZE : SIDE BAR	R A S V	_ _ _ 3	OK OR ERR
	INPUT 4 (VIDEO) RESIZE : SMART STRETCH	R A S V	_ _ _ 4	OK OR ERR
	INPUT 4 (VIDEO) RESIZE : CINEMA ZOOM	R A S V	_ _ _ 1	OK OR ERR
	INPUT 4 (VIDEO) RESIZE : STRETCH	R A S V	_ _ _ 2	OK OR ERR
	INPUT 5 RESIZE : SIDE BAR	R C S R	_ _ _ 3	OK OR ERR
	INPUT 5 RESIZE : SMART STRETCH	R C S R	_ _ _ 4	OK OR ERR
	INPUT 5 RESIZE : CINEMA ZOOM	R C S R	_ _ _ 1	OK OR ERR
	INPUT 5 RESIZE : STRETCH	R C S R	_ _ _ 2	OK OR ERR
PICTURE	INPUT 1 (COMPONENT 1) CONTRAST (-30 ~ +30)	R A P I	_ _ * *	OK OR ERR
	INPUT 1 (COMPONENT 1) BRIGHT (-30 ~ +30)	R A B R	_ _ * *	OK OR ERR
	INPUT 1 (COMPONENT 1) COLOR (-30 ~ +30)	R A C O	_ _ * *	OK OR ERR
	INPUT 1 (COMPONENT 1) TINT (-30 ~ +30)	R A T I	_ _ * *	OK OR ERR
	INPUT 1 (COMPONENT 1) SHARP (-30 ~ +30)	R A S H	_ _ * *	OK OR ERR
	INPUT 1 CLR TEMP (55 ~ 115)	R A C T	_ _ * *	OK OR ERR
	INPUT 1 (COMPONENT 1) DISPLAY	R A R E	_ _ _ 0	OK OR ERR
	INPUT 1 (COMPONENT 1) ADJUSTMENT RESET	R A R E	_ _ _ 1	OK OR ERR
	WHITE ENPHASIS : OFF	R A W E	_ _ _ 0	OK OR ERR
	WHITE ENPHASIS : ON	R A W E	_ _ _ 1	OK OR ERR
	INPUT 1 PICTURE SETTING : INPUT 1 MEMORY	R A P S	_ _ _ 0	OK OR ERR
	INPUT 1 PICTURE SETTING : MEMORY 1	R A P S	_ _ _ 1	OK OR ERR
	INPUT 1 PICTURE SETTING : MEMORY 2	R A P S	_ _ _ 2	OK OR ERR
	INPUT 1 PICTURE SETTING : MEMORY 3	R A P S	_ _ _ 3	OK OR ERR
	INPUT 1 PICTURE SETTING : MEMORY 4	R A P S	_ _ _ 4	OK OR ERR
	INPUT 1 PICTURE SETTING : MEMORY 5	R A P S	_ _ _ 5	OK OR ERR
	INPUT 2 (COMPONENT 2) CONTRAST (-30 ~ +30)	R B P I	_ _ * *	OK OR ERR
	INPUT 2 (COMPONENT 2) BRIGHT (-30 ~ +30)	R B B R	_ _ * *	OK OR ERR
	INPUT 2 (COMPONENT 2) COLOR (-30 ~ +30)	R B C O	_ _ * *	OK OR ERR
	INPUT 2 (COMPONENT 2) TINT (-30 ~ +30)	R B T I	_ _ * *	OK OR ERR
	INPUT 2 (COMPONENT 2) SHARP (-30 ~ +30)	R B S H	_ _ * *	OK OR ERR
	INPUT 2 CLR TEMP (55 ~ 115)	R B C T	_ _ * *	OK OR ERR
	INPUT 2 (COMPONENT 2) DISPLAY	R B R E	_ _ _ 0	OK OR ERR
	INPUT 2 (COMPONENT 2) ADJUSTMENT RESET	R B R E	_ _ _ 1	OK OR ERR
	WHITE ENPHASIS : OFF	R B W E	_ _ _ 0	OK OR ERR
	WHITE ENPHASIS : ON	R B W E	_ _ _ 1	OK OR ERR
	INPUT 2 PICTURE SETTING : INPUT 2 MEMORY	R B P S	_ _ _ 0	OK OR ERR
	INPUT 2 PICTURE SETTING : MEMORY 1	R B P S	_ _ _ 1	OK OR ERR
	INPUT 2 PICTURE SETTING : MEMORY 2	R B P S	_ _ _ 2	OK OR ERR
	INPUT 2 PICTURE SETTING : MEMORY 3	R B P S	_ _ _ 3	OK OR ERR
	INPUT 2 PICTURE SETTING : MEMORY 4	R B P S	_ _ _ 4	OK OR ERR
	INPUT 2 PICTURE SETTING : MEMORY 5	R B P S	_ _ _ 5	OK OR ERR
	INPUT 5 (COMPUTER-RGB) CONTRAST (-30 ~ +30)	R C P I	_ _ * *	OK OR ERR
	INPUT 5 (COMPUTER-RGB) BRIGHT (-30 ~ +30)	R C B R	_ _ * *	OK OR ERR
	INPUT 5 COLOR (-30 ~ +30)	R C C O	_ _ * *	OK OR ERR

	CONTROL CONTENTS	COMMAND	PARAMETER	RETURN
	INPUT 5 TINT (-30 ~ +30)	R C T I	_ _ * *	OK OR ERR
	INPUT 5 SHARP (-30 ~ +30)	R C S H	_ _ * *	OK OR ERR
	INPUT 5 CLR TEMP (55 ~ 115)	R C C T	_ _ * *	OK OR ERR
	INPUT 5 (COMPUTER-RGB) DISPLAY	R C R E	_ _ _ 0	OK OR ERR
	INPUT 5 (COMPUTER-RGB) ADJUSTMENT RESET	R C R E	_ _ _ 1	OK OR ERR
	WHITE ENPHASIS : OFF	R C W E	_ _ _ 0	OK OR ERR
	WHITE ENPHASIS : ON	R C W E	_ _ _ 1	OK OR ERR
	INPUT 5 PICTURE SETTING : INPUT 5 MEMORY	R C P S	_ _ _ 0	OK OR ERR
	INPUT 5 PICTURE SETTING : MEMORY 1	R C P S	_ _ _ 1	OK OR ERR
	INPUT 5 PICTURE SETTING : MEMORY 2	R C P S	_ _ _ 2	OK OR ERR
	INPUT 5 PICTURE SETTING : MEMORY 3	R C P S	_ _ _ 3	OK OR ERR
	INPUT 5 PICTURE SETTING : MEMORY 4	R C P S	_ _ _ 4	OK OR ERR
	INPUT 5 PICTURE SETTING : MEMORY 5	R C P S	_ _ _ 5	OK OR ERR
	INPUT 1 (COMPONENT 1) 2D PROGRESSIVE	R A I P	_ _ _ 0	OK OR ERR
	INPUT 1 (COMPONENT 1) 3D PROGRESSIVE	R A I P	_ _ _ 1	OK OR ERR
	INPUT 1 (COMPONENT 1) Film MODE	R A I P	_ _ _ 2	OK OR ERR
	INPUT 2 (COMPONENT 2) 2D PROGRESSIVE	R B I P	_ _ _ 0	OK OR ERR
	INPUT 2 (COMPONENT 2) 3D PROGRESSIVE	R B I P	_ _ _ 1	OK OR ERR
	INPUT 2 (COMPONENT 2) Film MODE	R B I P	_ _ _ 2	OK OR ERR
	INPUT 5 2D PROGRESSIVE	R C I P	_ _ _ 0	OK OR ERR
	INPUT 5 3D PROGRESSIVE	R C I P	_ _ _ 1	OK OR ERR
	INPUT 5 Film MODE	R C I P	_ _ _ 2	OK OR ERR
	INPUT 3 (S-VIDEO) CONTRAST (-30 ~ +30)	V B P I	_ _ * *	OK OR ERR
	INPUT 3 (S-VIDEO) BRIGHT (-30 ~ +30)	V B B R	_ _ * *	OK OR ERR
	INPUT 3 (S-VIDEO) COLOR (-30 ~ +30)	V B C O	_ _ * *	OK OR ERR
	INPUT 3 (S-VIDEO) TINT (-30 ~ +30)	V B T I	_ _ * *	OK OR ERR
	INPUT 3 (S-VIDEO) SHARP (-30 ~ +30)	V B S H	_ _ * *	OK OR ERR
	INPUT 3 CLR TEMP (55 ~ 115)	V B C T	_ _ * *	OK OR ERR
	INPUT 3 (S-VIDEO) DISPLAY	V B R E	_ _ _ 0	OK OR ERR
	INPUT 3 (S-VIDEO) ADJUSTMENT RESET	V B R E	_ _ _ 1	OK OR ERR
	WHITE ENPHASIS : OFF	V B W E	_ _ _ 0	OK OR ERR
	WHITE ENPHASIS : ON	V B W E	_ _ _ 1	OK OR ERR
	INPUT 3 PICTURE SETTING : INPUT 3 MEMORY	V B P S	_ _ _ 0	OK OR ERR
	INPUT 3 PICTURE SETTING : MEMORY 1	V B P S	_ _ _ 1	OK OR ERR
	INPUT 3 PICTURE SETTING : MEMORY 2	V B P S	_ _ _ 2	OK OR ERR
	INPUT 3 PICTURE SETTING : MEMORY 3	V B P S	_ _ _ 3	OK OR ERR
	INPUT 3 PICTURE SETTING : MEMORY 4	V B P S	_ _ _ 4	OK OR ERR
	INPUT 3 PICTURE SETTING : MEMORY 5	V B P S	_ _ _ 5	OK OR ERR
	INPUT 4 (VIDEO) CONTRAST (-30 ~ +30)	V A P I	_ _ * *	OK OR ERR
	INPUT 4 (VIDEO) BRIGHT (-30 ~ +30)	V A B R	_ _ * *	OK OR ERR
	INPUT 4 (VIDEO) COLOR (-30 ~ +30)	V A C O	_ _ * *	OK OR ERR
	INPUT 4 (VIDEO) TINT (-30 ~ +30)	V A T I	_ _ * *	OK OR ERR
	INPUT 4 (VIDEO) SHARP (-30 ~ +30)	V A S H	_ _ * *	OK OR ERR
	INPUT 4 CLR TEMP (55 ~ 115)	V A C T	_ _ * *	OK OR ERR
	INPUT 4 (VIDEO) DISPLAY	V A R E	_ _ _ 0	OK OR ERR
	INPUT 4 (VIDEO) ADJUSTMENT RESET	V A R E	_ _ _ 1	OK OR ERR
	WHITE ENPHASIS : OFF	V A W E	_ _ _ 0	OK OR ERR
	WHITE ENPHASIS : ON	V A W E	_ _ _ 1	OK OR ERR
	INPUT 4 PICTURE SETTING : INPUT 4 MEMORY	V A P S	_ _ _ 0	OK OR ERR
	INPUT 4 PICTURE SETTING : MEMORY 1	V A P S	_ _ _ 1	OK OR ERR
	INPUT 4 PICTURE SETTING : MEMORY 2	V A P S	_ _ _ 2	OK OR ERR
	INPUT 4 PICTURE SETTING : MEMORY 3	V A P S	_ _ _ 3	OK OR ERR
	INPUT 4 PICTURE SETTING : MEMORY 4	V A P S	_ _ _ 4	OK OR ERR
	INPUT 4 PICTURE SETTING : MEMORY 5	V A P S	_ _ _ 5	OK OR ERR
	INPUT 3 (S-VIDEO) 2D PROGRESSIVE	V B I P	_ _ _ 0	OK OR ERR
	INPUT 3 (S-VIDEO) 3D PROGRESSIVE	V B I P	_ _ _ 1	OK OR ERR
	INPUT 3 (S-VIDEO) Film MODE	V B I P	_ _ _ 2	OK OR ERR
	INPUT 4 (VIDEO) 2D PROGRESSIVE	V A I P	_ _ _ 0	OK OR ERR
	INPUT 4 (VIDEO) 3D PROGRESSIVE	V A I P	_ _ _ 1	OK OR ERR
	INPUT 4 (VIDEO) Film MODE	V A I P	_ _ _ 2	OK OR ERR
GAMMA	INPUT 1 GAMMA POSITION : STANDARD	G M R A	_ _ _ 0	OK OR ERR
	INPUT 1 GAMMA POSITION : BLACK DETAIL	G M R A	_ _ _ 1	OK OR ERR
	INPUT 1 GAMMA POSITION : BRIGHTEN	G M R A	_ _ _ 2	OK OR ERR
	INPUT 1 GAMMA POSITION : CUSTOM 1	G M R A	_ _ _ 3	OK OR ERR
	INPUT 1 GAMMA POSITION : CUSTOM 2	G M R A	_ _ _ 4	OK OR ERR
	INPUT 1 GAMMA POSITION : SVM GAMMA	G M R A	_ _ _ 5	OK OR ERR

Appendix



	CONTROL CONTENTS	COMMAND	PARAMETER	RETURN	
GAMMA	INPUT 2 GAMMA POSITION : STANDARD	G M R B	0	OK OR ERR	
	INPUT 2 GAMMA POSITION : BLACK DETAIL	G M R B	1	OK OR ERR	
	INPUT 2 GAMMA POSITION : BRIGHTEN	G M R B	2	OK OR ERR	
	INPUT 2 GAMMA POSITION : CUSTOM 1	G M R B	3	OK OR ERR	
	INPUT 2 GAMMA POSITION : CUSTOM 2	G M R B	4	OK OR ERR	
	INPUT 2 GAMMA POSITION : SVM GAMMA	G M R B	5	OK OR ERR	
	INPUT 3 GAMMA POSITION : STANDARD	G M V B	0	OK OR ERR	
	INPUT 3 GAMMA POSITION : BLACK DETAIL	G M V B	1	OK OR ERR	
	INPUT 3 GAMMA POSITION : BRIGHTEN	G M V B	2	OK OR ERR	
	INPUT 3 GAMMA POSITION : CUSTOM 1	G M V B	3	OK OR ERR	
	INPUT 3 GAMMA POSITION : CUSTOM 2	G M V B	4	OK OR ERR	
	INPUT 3 GAMMA POSITION : SVM GAMMA	G M V B	5	OK OR ERR	
	INPUT 4 GAMMA POSITION : STANDARD	G M V A	0	OK OR ERR	
	INPUT 4 GAMMA POSITION : BLACK DETAIL	G M V A	1	OK OR ERR	
	INPUT 4 GAMMA POSITION : BRIGHTEN	G M V A	2	OK OR ERR	
	INPUT 4 GAMMA POSITION : CUSTOM 1	G M V A	3	OK OR ERR	
	INPUT 4 GAMMA POSITION : CUSTOM 2	G M V A	4	OK OR ERR	
	INPUT 4 GAMMA POSITION : SVM GAMMA	G M V A	5	OK OR ERR	
	INPUT 5 GAMMA POSITION : STANDARD	G M R C	0	OK OR ERR	
	INPUT 5 GAMMA POSITION : BLACK DETAIL	G M R C	1	OK OR ERR	
	INPUT 5 GAMMA POSITION : BRIGHTEN	G M R C	2	OK OR ERR	
	INPUT 5 GAMMA POSITION : CUSTOM 1	G M R C	3	OK OR ERR	
	INPUT 5 GAMMA POSITION : CUSTOM 2	G M R C	4	OK OR ERR	
	INPUT 5 GAMMA POSITION : SVM GAMMA	G M R C	5	OK OR ERR	
	R-GAMMA (-30 ~ +30)	G M E R	*	OK OR ERR	
	G-GAMMA (-30 ~ +30)	G M E G	*	OK OR ERR	
	B-GAMMA (-30 ~ +30)	G M E B	*	OK OR ERR	
	R-GAIN (-30 ~ +30)	G M G R	*	OK OR ERR	
	G-GAIN (-30 ~ +30)	G M G G	*	OK OR ERR	
	B-GAIN (-30 ~ +30)	G M G B	*	OK OR ERR	
	R-OFFSET (-30 ~ +30)	G M O R	*	OK OR ERR	
	G-OFFSET (-30 ~ +30)	G M O G	*	OK OR ERR	
	B-OFFSET (-30 ~ +30)	G M O B	*	OK OR ERR	
	GAMMA RESET	G M R E	1	OK OR ERR	
	C.M.S.	INPUT 1 COLOR SELECTED : STANDARD	C S R A	0	OK OR ERR
		INPUT 1 COLOR SELECTED : CUSTOM 1	C S R A	1	OK OR ERR
		INPUT 1 COLOR SELECTED : CUSTOM 2	C S R A	2	OK OR ERR
		INPUT 1 COLOR SELECTED : CUSTOM 3	C S R A	3	OK OR ERR
		INPUT 2 COLOR SELECTED : STANDARD	C S R B	0	OK OR ERR
		INPUT 2 COLOR SELECTED : CUSTOM 1	C S R B	1	OK OR ERR
		INPUT 2 COLOR SELECTED : CUSTOM 2	C S R B	2	OK OR ERR
		INPUT 2 COLOR SELECTED : CUSTOM 3	C S R B	3	OK OR ERR
		INPUT 3 COLOR SELECTED : STANDARD	C S V B	0	OK OR ERR
		INPUT 3 COLOR SELECTED : CUSTOM 1	C S V B	1	OK OR ERR
		INPUT 3 COLOR SELECTED : CUSTOM 2	C S V B	2	OK OR ERR
INPUT 3 COLOR SELECTED : CUSTOM 3		C S V B	3	OK OR ERR	
INPUT 4 COLOR SELECTED : STANDARD		C S V A	0	OK OR ERR	
INPUT 4 COLOR SELECTED : CUSTOM 1		C S V A	1	OK OR ERR	
INPUT 4 COLOR SELECTED : CUSTOM 2		C S V A	2	OK OR ERR	
INPUT 4 COLOR SELECTED : CUSTOM 3		C S V A	3	OK OR ERR	
INPUT 5 COLOR SELECTED : STANDARD		C S R C	0	OK OR ERR	
INPUT 5 COLOR SELECTED : CUSTOM 1		C S R C	1	OK OR ERR	
INPUT 5 COLOR SELECTED : CUSTOM 2		C S R C	2	OK OR ERR	
INPUT 5 COLOR SELECTED : CUSTOM 3		C S R C	3	OK OR ERR	
TARGET : RED		C M T G	1	OK OR ERR	
TARGET : YELLOW		C M T G	2	OK OR ERR	
TARGET : GREEN		C M T G	3	OK OR ERR	
TARGET : CYAN		C M T G	4	OK OR ERR	
TARGET : BLUE		C M T G	5	OK OR ERR	
TARGET : MAGENTA		C M T G	6	OK OR ERR	
LIGHTNESS (-30 ~ +30)		C M S L	*	OK OR ERR	
CHROMA (-30 ~ +30)		C M S C	*	OK OR ERR	
HUE (-30 ~ +30)		C M S H	*	OK OR ERR	
RESET (THIS COLOR)		C M R E	1	OK OR ERR	
RESET (ALL COLORS)	C M R E	2	OK OR ERR		

	CONTROL CONTENTS	COMMAND	PARAMETER	RETURN
FINE SYNC	CLOCK (-150 ~ +150)	I N C L	* * * *	OK OR ERR
	PHASE (-60 ~ +60)	I N P H	* * * *	OK OR ERR
	H-POSITION (-150 ~ +150)	I A H P	* * * *	OK OR ERR
	V-POSITION (-60 ~ +60)	I A V P	* * * *	OK OR ERR
	RGB INPUT DISPLAY	I A R E	0	OK OR ERR
	RGB ADJUSTMENT RESET	I A R E	1	OK OR ERR
	SAVE SETTING (1 ~ 7)	M E M S	*	OK OR ERR
	SELECT SETTING (1 ~ 7)	M E M L	*	OK OR ERR
	RGB HORIZONTAL FREQUENCY CHECK	T F R Q	1	kHz (**, *OR_)
	RGB VERTICAL FREQUENCY CHECK	T F R Q	2	Hz (**, *OR_)
	NORMAL AUTO SYNC	A A D J	1	OK OR ERR
	HIGH SPEED AUTO SYNC	A A D J	2	OK OR ERR
	AUTO SYNC OFF	A A D J	0	OK OR ERR
	AUTO SYNC DISPLAY ON	I M A S	1	OK OR ERR
	AUTO SYNC DISPLAY OFF	I M A S	0	OK OR ERR
	DIGITAL SHIFT (-30 ~ +30)	S T S H	* * *	OK OR ERR
	SUBTITLE (-30 ~ +30)	S T S Z	* * *	OK OR ERR
	POWER SAVE MODE : ON	T H M D	1	OK OR ERR
	POWER SAVE MODE : OFF	T H M D	0	OK OR ERR
	3D DNR : OFF	3 D N R	0	OK OR ERR
	3D DNR : LEVEL 1	3 D N R	1	OK OR ERR
	3D DNR : LEVEL 2	3 D N R	2	OK OR ERR
	3D DNR : LEVEL 3	3 D N R	3	OK OR ERR
	OSD DISPLAY : NORMAL	I M D I	1	OK OR ERR
	OSD DISPLAY : LEVEL A	I M D I	2	OK OR ERR
OSD DISPLAY : LEVEL B	I M D I	0	OK OR ERR	
INPUT 1 SIGNAL TYPE : RGB	I A S I	1	OK OR ERR	
INPUT 1 SIGNAL TYPE : COMPONENT	I A S I	2	OK OR ERR	
INPUT 2 SIGNAL TYPE : RGB	I B S I	1	OK OR ERR	
INPUT 2 SIGNAL TYPE : COMPONENT	I B S I	2	OK OR ERR	
OPTIONS	VIDEO SYSTEM SELECTION : AUTO	M E S Y	1	OK OR ERR
	VIDEO SYSTEM SELECTION : PAL	M E S Y	2	OK OR ERR
	VIDEO SYSTEM SELECTION : SECAM	M E S Y	3	OK OR ERR
	VIDEO SYSTEM SELECTION : NTSC4.43	M E S Y	4	OK OR ERR
	VIDEO SYSTEM SELECTION : NTSC3.58	M E S Y	5	OK OR ERR
	VIDEO SYSTEM SELECTION : PAL_M	M E S Y	6	OK OR ERR
	VIDEO SYSTEM SELECTION : PAL_N	M E S Y	7	OK OR ERR
	INPUT 5 SIGNAL TYPE : ANALOG RGB	I C S I	1	OK OR ERR
	INPUT 5 SIGNAL TYPE : ANALOG COMPONENT	I C S I	2	OK OR ERR
	INPUT 5 SIGNAL TYPE : DIGITAL COMPUTER (RGB)	I C S I	3	OK OR ERR
	INPUT 5 SIGNAL TYPE : DIGITAL COMPUTER (COMPONENT)	I C S I	4	OK OR ERR
	INPUT 5 SIGNAL TYPE : DIGITAL VIDEO (RGB)	I C S I	5	OK OR ERR
	INPUT 5 SIGNAL TYPE : DIGITAL VIDEO (COMPONENT)	I C S I	6	OK OR ERR
	BACKGROUND SELECTION : BLUE	I M B G	1	OK OR ERR
	BACKGROUND SELECTION : NONE	I M B G	2	OK OR ERR
AUTO POWER OFF : NO USE	A P O W	0	OK OR ERR	
AUTO POWER OFF : USE	A P O W	1	OK OR ERR	
LAMP USAGE TIME	T L T T	1	0~9999 (INTEGER)	
PROJECTION MODE : FRONT	I M P J	0	OK OR ERR	
PROJECTION MODE : CEILING + FRONT	I M P J	1	OK OR ERR	
PROJECTION MODE : REAR	I M P J	2	OK OR ERR	
PROJECTION MODE : CEILING + REAR	I M P J	3	OK OR ERR	
LANGUAGE	LANGUAGE SELECTION : ENGLISH	M E L A	1	OK OR ERR
	LANGUAGE SELECTION : DEUTSCH	M E L A	2	OK OR ERR
	LANGUAGE SELECTION : ESPAÑOL	M E L A	3	OK OR ERR
	LANGUAGE SELECTION : NEDERLANDS	M E L A	4	OK OR ERR
	LANGUAGE SELECTION : FRANÇAIS	M E L A	5	OK OR ERR
	LANGUAGE SELECTION : ITALIANO	M E L A	6	OK OR ERR
	LANGUAGE SELECTION : SVENSKA	M E L A	7	OK OR ERR
	LANGUAGE SELECTION : 日本語	M E L A	8	OK OR ERR
	LANGUAGE SELECTION : PORTUGUÉS	M E L A	9	OK OR ERR
	LANGUAGE SELECTION : 汉语	M E L A	10	OK OR ERR
LANGUAGE SELECTION : 한국어	M E L A	11	OK OR ERR	

Note

- If an underbar (_) appears in the parameter column, enter a space. If an asterisk (*) appears, enter a value in the range indicated in brackets under CONTROL CONTENTS.
- * FINE SYNC can only be set in the displayed RGB mode.

Wired Remote Control Terminal Specifications

Specifications of wired remote control input

- $\varnothing 3.5$ mm minijack
- External: GND
- Internal: +3.3V

Function and transmission codes

CONTROL ITEM	SYSTEM CODE					DATA CODE								JUDGEMENT CODE	
	C1	C2	C3	C4	C5	C6	C7	C8	C9	C10	C11	C12	C13	C14	C15
ON	1	0	1	1	0	0	1	1	0	1	0	1	0	1	0
OFF	1	0	1	1	0	0	1	1	0	1	0	0	1	1	0
MENU	1	0	1	1	0	0	0	1	0	0	0	1	1	1	0
▲	1	0	1	1	0	0	0	1	1	1	0	0	1	1	0
▼	1	0	1	1	0	1	0	1	1	1	0	0	1	1	0
◀	1	0	1	1	0	0	0	0	0	1	0	1	0	1	0
▶	1	0	1	1	0	1	1	1	1	0	0	1	0	1	0
ENTER	1	0	1	1	0	1	1	1	0	1	0	1	0	1	0
UNDO	1	0	1	1	0	1	0	0	1	1	0	1	0	1	0
RGB/COMP.	1	0	1	1	0	1	0	0	0	1	1	1	1	1	0

CONTROL ITEM	SYSTEM CODE					DATA CODE								JUDGEMENT CODE	
	C1	C2	C3	C4	C5	C6	C7	C8	C9	C10	C11	C12	C13	C14	C15
RESIZE	1	0	1	1	0	0	1	1	1	1	0	1	0	1	0
PICTURE SETTING	1	0	1	1	0	1	0	0	1	1	1	0	0	1	0
AUTO SYNC	1	0	1	1	0	0	1	0	1	1	1	1	1	1	0
KEYSTONE	1	0	1	1	0	1	1	1	1	1	1	0	1	1	0
INPUT 1	1	0	1	1	0	0	1	0	1	1	0	0	0	1	0
INPUT 2	1	0	1	1	0	0	1	0	1	1	1	0	0	1	0
INPUT 3	1	0	1	1	0	1	1	1	0	1	1	0	0	1	0
INPUT 4	1	0	1	1	0	0	1	0	0	1	1	0	0	1	0
INPUT 5	1	0	1	1	0	1	0	1	0	1	1	0	0	1	0

Wired remote control function code
LSB

MSB

C1	System Code	C5	C6	Data Code	C13	C14	C15	
1	0	1	1	0	*	*	1	0

- System codes C1 to C5 are fixed at "10110".
- Codes C14 and C15 are reverse confirmation bits, with "10" indicating "Front" and "01" indicating "Rear".

Sharp remote control signal format

Transmission format: 15-bit format

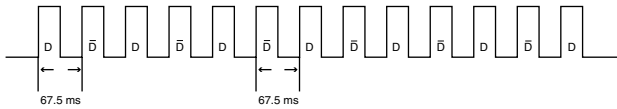

Wave form of output signal: Output using Pulse Position Modulation

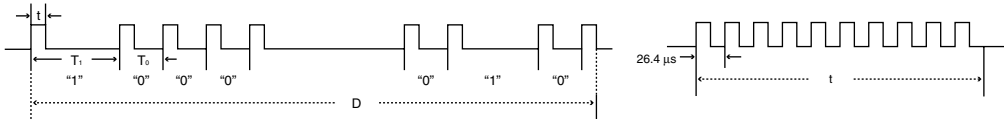

- $t = 264 \mu s$
- $T_0 = 1.05 ms$
- $T_1 = 2.10 ms$
- Pulse carrier frequency = 37.917 kHz
- Duty ratio = 1:1

Transmission control code

15 bit

C1	C2	C3	C4	C5	C6	C7	C8	C9	C10	C11	C12	C13	C14	C15	
System Address					Function Key Data Bit					Data Expansion	Mask	Data Determination			
D to \bar{D} Common Data Bit					Reverse in \bar{D}										

Example of Reverse D to \bar{D}

D	C1	C2	C3	C4	C5	C6	C7	C8	C9	C10	C11	C12	C13	C14	C15
	1	0	1	1	0	1	0	0	0	0	0	0	0	1	0
\bar{D}	C1	C2	C3	C4	C5	C6	C7	C8	C9	C10	C11	C12	C13	C14	C15
	1	0	1	1	0	0	1	1	1	1	1	1	1	0	1



Computer Compatibility Chart

Computer

- Multiple signal support
Horizontal Frequency: 15–81 kHz, Vertical Frequency: 43–100 Hz, Pixel Clock: 12–120 MHz
- Compatible with sync on green and composite sync signals
- SXGA compatible in advanced intelligent compression
- AICS (Advanced Intelligent Compression and Expansion System) resizing technology

The following is a list of modes that conform to VESA. However, this projector supports other signals that are not VESA standards.

PC/MAC/WS	Resolution	Horizontal Frequency (kHz)	Vertical Frequency (Hz)	VESA Standard	DVI Support	Display	
PC	640 × 350	27.0	60			Upscale	
		31.5	70				
		37.9	85	✓			
	720 × 350	27.0	60				
		31.5	70				
		37.9	85	✓			
	640 × 400	27.0	60				
		31.5	70		✓		
		37.9	85	✓	✓		
	720 × 400	27.0	60		✓		
		31.5	70		✓		
		37.9	85	✓	✓		
	VGA	640 × 480	26.2	50			✓
			31.5	60			✓
			36.8	70			✓
		800 × 600	37.9	75	✓		✓
			43.3	85	✓		✓
			47.9	90			✓
	SVGA	800 × 600	53.0	100			✓
			31.4	50			✓
			35.1	56	✓		✓
		1,024 × 768	37.9	60	✓		✓
			44.5	70			✓
			48.1	72	✓		✓
	XGA	1,024 × 768	46.9	75	✓		✓
			53.7	85	✓		✓
			56.8	90			✓
			64.0	100			✓
			35.5	43			✓
			40.3	50			✓
48.4			60	✓	✓		
56.5			70	✓	✓		
60.0			75	✓	✓		
68.7			85	✓	✓		
73.5	90		✓				
77.2	96		✓				
80.6	100		✓				

PC/MAC/WS	Resolution	Horizontal Frequency (kHz)	Vertical Frequency (Hz)	VESA Standard	DVI Support	Display	
PC	SXGA	1,152 × 864	54.3	60		✓	Advanced Intelligent Compression
			64.0	70		✓	
			64.1	85		✓	
			67.5	60	✓	✓	
			75.7	70		✓	
		1,152 × 882	54.8	60		✓	
			65.9	72		✓	
			67.4	74		✓	
			67.4	74		✓	
			64.0	60	✓	✓	
MAC 13"	VGA	640 × 480	34.9	67			Upscale
MAC 16"	SVGA	832 × 624	49.6	75			
MAC 19"	XGA	1,024 × 768	48.4	60	✓		True
MAC 21"	SXGA	1,152 × 870	68.5	75			Advanced Intelligent Compression
PC (WS)	SXGA	1,280 × 960	60.0	60	✓	✓	
SGL (WS)							
SUN (WS)							
SUN (WS)							
		1,280 × 900	60.9	66			
			71.9	76			

Note





- This projector may not be able to display images from notebook computers in simultaneous (CRT/LCD) mode. Should this occur, turn off the LCD display on the notebook computer and output the display data in "CRT only" mode. Details on how to change display modes can be found in your notebook computer's operation manual.
- When this projector receives 640 × 350 VESA format VGA signals, "640 × 400" appears on the screen.
- When projecting video images of an interlace video signal with the projector, the intended image may not be projected depending on the video signal when using the RGB input. In such cases, use the component input, S-video input or video input.

DTV

Signal	Horizontal Frequency (kHz)	Vertical Frequency (Hz)	DVI Support
480I	15.8	60	
480P	31.5	60	✓
576I	15.6	50	
576P	31.3	50	✓
720P	45.0	60	✓
720P	37.5	50	✓
1080I	33.8	60	✓
1080I	28.1	50	✓

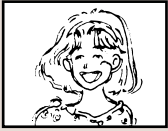
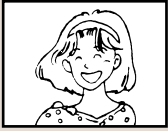

Troubleshooting

Problem	Check	Page
 No picture and no sound or projector does not start.	• Projector power cord is not plugged into the wall outlet.	16
	• Power to the external connected devices is off.	–
	• The selected input mode is wrong.	33
	• Cables incorrectly connected to rear panel of the projector.	17-22
	• Remote control batteries have run out.	13
	• External output has not been set when connecting notebook computer.	–
	• The cover of the lamp unit is not installed correctly.	78
 No picture appears in INPUT 5.	• The selected “Signal Type” is wrong.	64
 Sound is heard but no picture appears.	• Cables incorrectly connected to the rear panel of the projector.	17-22
	• “Bright” is set to minimum position.	44
 Color is faded or poor.	• Picture adjustments are incorrectly set.	44
	(Video Input only) • Video input system is incorrectly set.	65
	(INPUT 1 and 2 only) • Input signal type (RGB/Component) is incorrectly set.	64
 Picture is blurred; noise appears.	• Adjust the focus.	26
	• The projection distance exceeds the focus range.	28-29
	(Computer Input only) • Perform “Fine Sync” Adjustments (“Clock” Adjustment) • Perform “Fine Sync” Adjustments (“Phase” Adjustment) • Noise will appear depending on the computer.	53 53 –
	• The “DNR” (Digital Noise Reduction) setting is not correct.	63
 Picture appears but no sound is heard.	• Cables incorrectly connected to rear panel of the projector.	17-22
An unusual sound is occasionally heard from the cabinet.	• If the picture is normal, the sound is due to cabinet shrinkage caused by a room temperature changes. This will not affect operation or performance.	–
Maintenance indicator illuminates.	• See “Maintenance Indicators”.	74

Troubleshooting

Problem	Check	Page
Picture is green on INPUT 1 or 2 COMPONENT. Picture is pink (no green) on INPUT 1 or 2 RGB.	<ul style="list-style-type: none"> • Change the input signal type setting. 	64
Picture is dark.	<ul style="list-style-type: none"> • The lamp replacement indicator is blinking in red. Replace the lamp. 	74
Picture is too bright and whitish.	<ul style="list-style-type: none"> • Picture adjustments are incorrectly set. 	44
A response code cannot be received when the projector was attempted to be controlled using RS-232C commands from a computer during standby.	<ul style="list-style-type: none"> • In the case of transmitting RS-232C commands from a computer during standby, it takes a maximum of 30 seconds for the computer to receive the response code. Set the response code waiting time of the computer to 30 seconds or more. 	80

For SHARP Assistance (U.S.A only)

If you encounter any problems during setup or operation of this projector, first refer to the "Troubleshooting" section on this page. If this operation manual does not answer your question, please call toll free 1-877-DTV-SHARP (1-877-388-7427) for further assistance. Or, send us an e-mail at lcdsupport@sharpsec.com.

Our World Wide Web address is <http://www.sharpusa.com/>.



Specifications

Product type	Projector
Model	XV-Z10000
Video system	NTSC 3.58/NTSC 4.43/PAL/PAL-M/PAL-N/PAL 60/SECAM DTV480I/DTV480P/DTV720P/DTV1080I
Display method	DLP chip, RGB optical shutter method
DLP panel	Panel size: 0.8" (XX mm) (XX [H] × XX [W] mm) Display method: Single Panel Digital Micromirror Device (DMD™) by Texas Instruments Drive method: Digital Light Processing (DLP™) No. of dots: 921,600 dots (1,280 [H] × 720 [V])
Lens	1–1.35 × zoom lens, F3.8, f = 32.5–44.0 mm
Projection lamp	270 W SHP lamp
S-video input signal	4-pin Mini DIN connector (INPUT 3) Y (luminance signal): 1.0 Vp-p, sync negative, 75 Ω terminated C (chrominance signal): Burst 0.286 Vp-p, 75 Ω terminated
Component input signal	RCA Connector (INPUT 1, 2) Y: 1.0 Vp-p, sync negative, 75 Ω terminated PB: 0.7 Vp-p, 75 Ω terminated PR: 0.7 Vp-p, 75 Ω terminated
Horizontal resolution	520 TV lines (NTSC 3.58 input), 750 TV lines (DTV 720P input)
RGB input signal	DVI-I terminal: (INPUT 5)/RCA connector: INPUT 1/2 <Digital> Input impedance 50 Ω Input level 250-1000mV <Analog> Input Impedance 75 Ω Input level 0.7Vp-p <Synchronization signal> • Separate sync / Composite sync Input level TTL level Input impedance 1K Ω • Green on sync Input level (Synchronising input) 0.286Vp-p Input Impedance 75 Ω
Video input signal	RCA Connector: VIDEO (INPUT 4), composite video, 1.0 Vp-p, sync negative, 75 Ω terminated
Computer control signal	9-pin D-sub connector (RS-232C Port)
Pixel clock	12–120 MHz
Vertical frequency	43–100 Hz
Horizontal frequency	15–81 kHz
Rated voltage	AC 100–240 V
Input current	3.6 A
Rated frequency	50/60 Hz
Power consumption (normal)	365 W
Power consumption(standby)	About 0.2 W (When using 100 V)
Heat dissipation	1,400 BTU/hour
Operating temperature	41°F to 95°F (+5°C to +35°C)
Storage temperature	–4°F to 140°F (–20°C to +60°C)
Cabinet	Plastic
I/R carrier frequency	38 kHz
Dimensions (approx.)	18 11/16" × 7" × 15 49/50" (475 (W) × 178 (H) × 406 (D) mm) (main body only) 18 11/16" × 7" × 19 1/2" (475 (W) × 178 (H) × 496 (D) mm) (including terminal cover)
Weight (approx.)	20.7 lbs. (9.4 kg)
Supplied accessories	Remote control, Two AA size batteries, Power cord (11'10", 3.6 m), Terminal cover, Lens cap (attached), SharpVision Manager Software CD-ROM, Projector operation manual, SharpVision Manager operation manual
Replacement parts	Lamp unit (Lamp/cage module) (BQC-XVZ100001), Remote control (RRMCGA128WJSA), AA size batteries, Power cord (CACDDA010DE01), Terminal cover (CCOVA1985CE02), Lens cap (PCAPHA1056CESA), SharpVision Manager Software CD-ROM (UDSKAA019WJZZ), Projector operation manual (TINS-A440WJZZ), SharpVision Manager operation manual (TINS-A452WJZZ)

This SHARP projector uses a DMD Chip. This very sophisticated panel contains 921,600 pixels. As with any high technology electronic equipment such as large screen TVs, video systems and video cameras, there are certain acceptable tolerances that the equipment must conform to.

This unit has some inactive pixels within acceptable tolerances which may result in inactive dots on the picture screen. This will not affect the picture quality or the life expectancy of the unit. If you have any questions about this matter, please call toll free 1-877-DTV-SHARP (1-877-388-7427).

Specifications are subject to change without notice.

U.S.A ONLY



Dimensions

Units: inches (mm)

Rear View

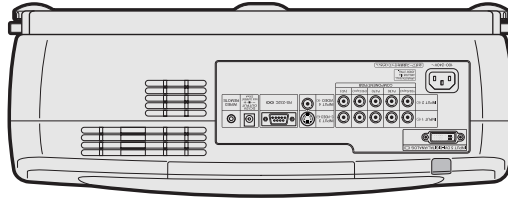

Side View

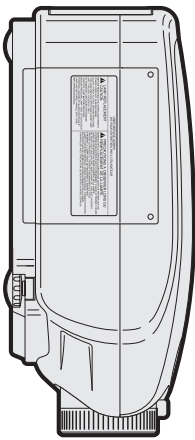

Top View

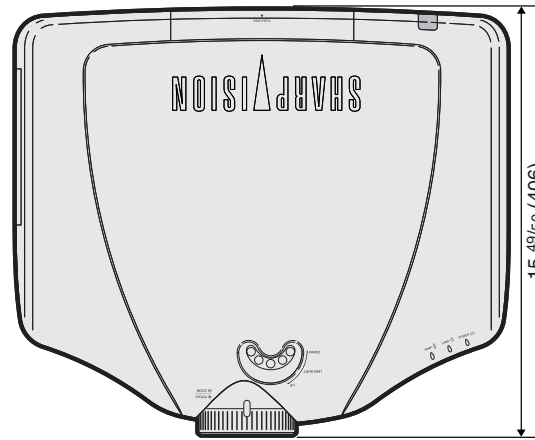

Side View

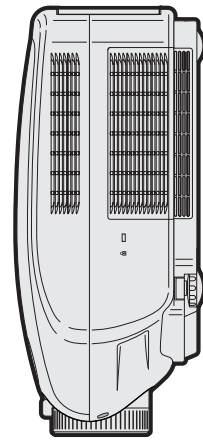

Front View

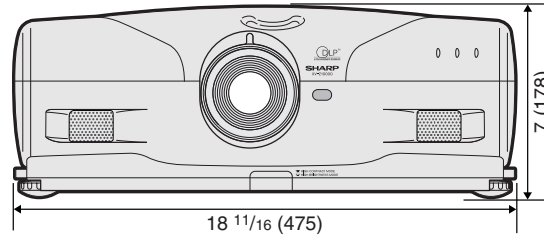

Bottom View

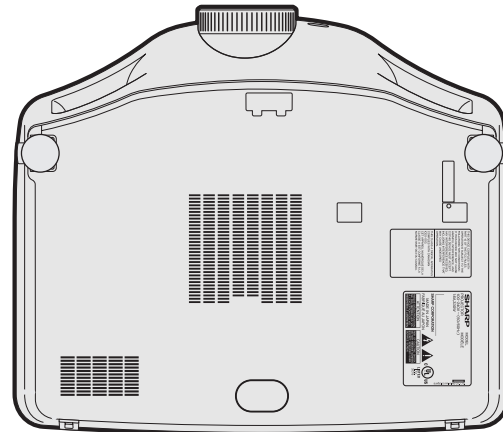



Glossary

Advanced intelligent compression

High quality resizing of lower and higher resolution images to fit the projector's native resolution.

Aspect Ratio

Width and height ratio of an image. The normal aspect ratio of a computer and video image is 4:3. There are also wide images with an aspect ratio of 16:9 and 21:9.

Auto Sync

Optimizes projected computer images by automatically adjusting certain characteristics.

Background

Initial setting image projected when no signal is being output.

Border

Projects a 4:3 image fully within a 16:9 screen by keeping the aspect ratio at 4:3.

Clock

Clock adjustment is used to adjust vertical noise when clock level is incorrect.

CLR Temp (Color temperature)

Function that can be used to adjust the color temperature to suit the type of image input to the projector. Decrease the color temperature to create warmer, reddish images for natural flesh tones, or increase to create cooler, bluish images for a brighter picture.

C.M.S. (Color Management System)

Function allows you individually adjust the display characteristics of six colors (R: Red, Y: Yellow, G: Green, C: Cyan, B: Blue, M: Magenta)

Digital Shift Setting

Shifts image up or down easily by ▲, ▼ buttons when RESIZE mode of input image is BORDER, STRETCH or SMART STRETCH of the video or the DTV signals.

Dot by dot

Mode that projects images in their native resolution.

Gamma

Image quality enhancement function that offers a richer image by brightening the darker portions of the image without altering the brightness of the brighter portions. You can select four different modes: STANDARD, PRESENTATION, CINEMA and CUSTOM.

Keystone correction

Function to digitally correct a distorted image when the projector is set up at an angle, smoothens out jaggies on keystone images and compresses the image not only horizontally but vertically keeping the 4:3 aspect ratio.

Phase

Phase shift is a timing shift between isomorphic signals with the same resolution. When phase level is incorrect, the projected image typically displays horizontal flicker.

Progressive Mode

The progressive display projects a smoother video image. You can select three different modes: 2D Progressive, 3D Progressive and Film Mode.

Resize

Allows you to modify or customize the picture display mode to enhance the input image. You can select six different modes: NORMAL, FULL, DOT BY DOT, BORDER, STRETCH and SMART STRETCH.

Smart Stretch

Projects the image fully in a 16:9 screen by enlarging only the surrounding areas while keeping the aspect ratio in the middle part of the image at 4:3.

Stretch

Mode that stretches the 4:3 image horizontally to display it fully on a 16:9 screen.



Index

2D Progressive	46	Lamp	76
3D Progressive	46	Lamp Life	76
AC socket	16	Lamp replacement indicator	32
Adjusting Computer Images	53	Lens cap	10
Adjusting the Lens	26	Lightness	51
Adjusting the Picture	44	MENU button	32
Adjustment buttons	32	NORMAL	58
Adjustment feet	25	Optional accessories	14
Aspect ratio	59	OSD Display	63
Auto Power off	68	PDF	9
Auto Sync adjustment	55	Phase	53
AUTO SYNC button	55	Power buttons	32
Auto Sync Disp	56	Power cord	16
Background	66	Power indicator	32
Batteries	13	PRJ mode	69
BORDER	56	Progressive Mode	46
Ceiling-mount setup	30	Remote control	12
Chroma	51	Remote control sensor	13
Clock	53	Replacing the lamp	76
CLR Temp (Color Temperature)	44	RESIZE button	58
C.M.S.	50	Reversing/Inverting Projected Images	69
Color Selected	50	RS-232C terminal	23
Digital Shift Setting	62	Save Setting	53
DNR	63	Select Setting	54
DOT BY DOT	58	Selecting the on-screen display language	34
ENTER button	32	Signal Info	55
Exhaust vent	73	Signal Type	64
Film Mode	46	SMART STRETCH	59
Fine Sync	53	Special Modes	54
Focus ring	26	Status	70
FULL	58	STRETCH	59
Hue	51	Supplied accessories	14
INPUT 1 terminals	19	Target	50
INPUT 1 – 5 modes	33	Temperature warning indicator	74
INPUT 2 terminals	18	UNDO button	37
INPUT 3 terminal	17	Video System	65
INPUT 4 terminal	17	WIRED R/C JACK	24
INPUT button	32	WIRED REMOTE control input terminal	24
Intake vent	73	Zoom knob	26
Kensington Security Standard connector	11		
KEYSTONE button	36		
Keystone correction	36		



VALID IN USA ONLY

CONSUMER LIMITED WARRANTY

SHARP ELECTRONICS CORPORATION warrants to the first consumer purchaser that this Sharp brand product (the "Product"), when shipped in its original container, will be free from defective workmanship and materials, and agrees that it will, at its option, either repair the defect or replace the defective Product or part thereof with a new or remanufactured equivalent at no charge to the purchaser for parts or labor for the period(s) set forth below.

This warranty does not apply to any appearance items of the Product nor to the additional excluded item(s) set forth below nor to any Product the exterior of which has been damaged or defaced, which has been subjected to improper voltage or other misuse, abnormal service or handling, or which has been altered or modified in design or construction.

In order to enforce the rights under this limited warranty, the purchaser should follow the steps set forth below and provide proof of purchase to the servicer.

The limited warranty described herein is in addition to whatever implied warranties may be granted to purchasers by law. ALL IMPLIED WARRANTIES INCLUDING THE WARRANTIES OF MERCHANTABILITY AND FITNESS FOR USE ARE LIMITED TO THE PERIOD(S) FROM THE DATE OF PURCHASE SET FORTH BELOW. Some states do not allow limitations on how long an implied warranty lasts, so the above limitation may not apply to you.

Neither the sales personnel of the seller nor any other person is authorized to make any warranties other than those described herein, or to extend the duration of any warranties beyond the time period described herein on behalf of Sharp.

The warranties described herein shall be the sole and exclusive warranties granted by Sharp and shall be the sole and exclusive remedy available to the purchaser. Correction of defects, in the manner and for the period of time described herein, shall constitute complete fulfillment of all liabilities and responsibilities of Sharp to the purchaser with respect to the Product, and shall constitute full satisfaction of all claims, whether based on contract, negligence, strict liability or otherwise. In no event shall Sharp be liable, or in any way responsible, for any damages or defects in the Product which were caused by repairs or attempted repairs performed by anyone other than an authorized servicer. Nor shall Sharp be liable or in any way responsible for any incidental or consequential economic or property damage. Some states do not allow the exclusion of incidental or consequential damages, so the above exclusion may not apply to you.

THIS WARRANTY GIVES YOU SPECIFIC LEGAL RIGHTS. YOU MAY ALSO HAVE OTHER RIGHTS WHICH VARY FROM STATE TO STATE.

Model Specific Section (In-Home Service)	XV-Z10000 Projector
<u>Your Product Model Number & Description:</u>	(Be sure to have this information available when you need service for your Product.)
<u>Warranty Period for this Product:</u>	One (1) year parts and labor from date of purchase except for the Projector Lamp for which the warranty period is ninety (90) days from date of purchase. After the ninety (90) day warranty period on the Projector Lamp, parts and labor for a lamp replacement are the responsibility of the consumer.
<u>Additional Item(s) Excluded from Warranty Coverage (if any):</u>	Cleaning of Optical System and/or replacement of any filter. Labor & materials required to remove and reinstall a suspended projector in installations not accessible with a standard (8' step) ladder or ceilings exceeding 12' in height.
<u>Where to Obtain Service:</u>	Labor & materials required to remove and reinstall a projector in complex systems including, but not limited to, projectors installed in custom enclosures, projectors connected to third party control and automation systems, and realignment of projectors installed in "mirrored" rear projection enclosures.
<u>What to do to Obtain Service:</u>	From a Sharp Authorized Servicer located in the United States. To find the location of the nearest Sharp Authorized Servicer, call Sharp toll free at 1-800-BE-SHARP. Contact your Sharp Authorized Servicer to obtain in-home service for this Product. The Servicer will come to your home and if necessary to remove the Product for repair at the Servicer's facility, the Servicer will reinstall it upon completion of repair. Be sure to have Proof of Purchase available.

TO OBTAIN PRODUCT INFORMATION, CALL 1-877-DTV-SHARP OR VISIT www.sharppusa.com.



VALID IN CANADA ONLY

SHARP[®] LIMITED WARRANTY

Consumer Electronics Products Congratulations on your purchase!

Sharp Electronics of Canada Ltd. (hereinafter called "Sharp") gives the following express warranty to the first consumer purchaser for this Sharp brand product, when shipped in its original container and sold or distributed in Canada by Sharp or by an Authorized Sharp Dealer:

Sharp warrants that this product is free, under normal use and maintenance, from any defects in material and workmanship. If any such defects should be found in this product within the applicable warranty period, Sharp shall, at its option, repair or replace the product as specified herein.

This warranty shall not apply to:

- (a) Any defects caused or repairs required as a result of abusive operation, negligence, accident, improper installation or inappropriate use as outlined in the owner's manual.
- (b) Any Sharp product tampered with, modified, adjusted or repaired by any party other than Sharp, Sharp's Authorized Service Centres or Sharp's Authorized Servicing Dealers.
- (c) Damage caused or repairs required as a result of the use with items not specified or approved by Sharp, including but not limited to head cleaning tapes and chemical cleaning agents.
- (d) Any replacement of accessories, glassware, consumable or peripheral items required through normal use of the product including but not limited to earphones, remote controls, AC adapters, batteries, temperature probe, stylus, trays, filters, belts, ribbons, cables and paper.
- (e) Any cosmetic damage to the surface or exterior that has been defaced or caused by normal wear and tear.
- (f) Any damage caused by external or environmental conditions, including but not limited to transmission line/power line voltage or liquid spillage.
- (g) Any product received without appropriate model, serial number and CSA/cUL markings.
- (h) Any products used for rental or commercial purposes.
- (i) Any installation, setup and/or programming charges.

Should this Sharp product fail to operate during the warranty period, warranty service may be obtained upon delivery of the Sharp product together with proof of purchase and a copy of this LIMITED WARRANTY statement to an Authorized Sharp Service Centre or an Authorized Sharp Servicing Dealer. In home warranty service may be provided at Sharp's discretion on any Sharp television with the screen size of 27" or larger and on any Sharp Over The Range Microwave Oven.

This warranty constitutes the entire express warranty granted by Sharp and no other dealer, service centre or their agent or employee is authorized to extend, enlarge or transfer this warranty on behalf of Sharp. To the extent the law permits, Sharp disclaims any and all liability for direct or indirect damages or losses or for any incidental, special or consequential damages or loss of profits resulting from a defect in material or workmanship relating to the product, including damages for the loss of time or use of this Sharp product or the loss of information. The purchaser will be responsible for any removal, reinstallation, transportation and insurance costs incurred. Correction of defects, in the manner and period of time described herein, constitute complete fulfillment of all obligations and responsibilities of Sharp to the purchaser with respect to the product and shall constitute full satisfaction of all claims, whether based on contract, negligence, strict liability or otherwise.

WARRANTY PERIODS

Projector	1 years (bulb 90 days)
-----------	------------------------

To obtain the name and address of the nearest Authorized Sharp Service Centre or Dealer, please contact:
SHARP ELECTRONICS OF CANADA LTD.

SHARP ELECTRONICS OF CANADA LTD
335 Britannia Road East
Mississauga, Ontario
L4Z 1W9
(905) 568-7140
Web site: www.sharp.ca

