

Before using the LCD projector, please read this operation manual carefully.

OPERATION MANUAL

ENGLISH

IMPORTANT

For your assistance in reporting the loss or theft of your Color LCD Projector, please record the Serial Number located on the bottom of the projector and retain this information. Before recycling the packaging, please be sure that you have checked the contents of the carton thoroughly against the list of "Supplied Accessories" on page 10.

Model No.: XV-Z7000U

Serial No.:

There are two important reasons for prompt warranty registration of your new SHARP LCD Projector, using the REGISTRATION CARD packed with the projector.

1. WARRANTY

This is to assure that you immediately receive the full benefit of the parts, service and labor warranty applicable to your purchase.



2. CONSUMER PRODUCT SAFETY ACT

To ensure that you will promptly receive any safety notification of inspection, modification, or recall that SHARP may be required to give under the 1972 Consumer Product Safety Act, PLEASE READ CAREFULLY THE IMPORTANT "LIMITED WARRANTY" CLAUSE.

U.S.A. ONLY

WARNING: High brightness light source. Do not stare into the beam of light, or view directly. Be especially careful that children do not stare directly into the beam of light.

WARNING: To reduce the risk of fire or electric shock, do not expose this product to rain or moisture.

	CAUTION RISK OF ELECTRIC SHOCK. DO NOT REMOVE SCREWS EXCEPT SPECIFIED USER SERVICE SCREW.	
CAUTION: TO REDUCE THE RISK OF ELECTRIC SHOCK, DO NOT REMOVE COVER. NO USER-SERVICEABLE PARTS EXCEPT LAMP UNIT. REFER SERVICING TO QUALIFIED SERVICE PERSONNEL.		



The lightning flash with arrowhead symbol, within an equilateral triangle, is intended to alert the user to the presence of uninsulated "dangerous voltage" within the product's enclosure that may be of sufficient magnitude to constitute a risk or electric shock to persons.



The exclamation point within a triangle is intended to alert the user to the presence of important operating and maintenance (servicing) instructions in the literature accompanying the product.

WARNING: FCC Regulations state that any unauthorized changes or modifications to this equipment not expressly approved by the manufacturer could void the user's authority to operate this equipment.

U.S.A. ONLY

The enclosed computer cable must be used with the device. The cable is provided to ensure that the device complies with FCC Rules.

U.S.A. ONLY

PRODUCT DISPOSAL

This product utilizes tin-lead solder, and high intensity discharge lamp (HID lamp) containing a small amount of mercury. Disposal of these materials may be regulated due to environmental considerations. For disposal or recycling information, please contact your local authorities or the Electronics Industries Alliance: www.eiae.org.

INFORMATION

This equipment has been tested and found to comply with the limits for a Class B digital device, pursuant to Part 15 of the FCC Rules. These limits are designed to provide reasonable protection against harmful interference in a residential installation. This equipment generates, uses, and can radiate radio frequency energy and, if not installed and used in accordance with the operation manual, may cause harmful interference to radio communications. However, there is no guarantee that interference will not occur in a particular installation. If this equipment does cause harmful interference to radio or television reception, which can be determined by turning the equipment off and on, the user is encouraged to try to correct the interference by one or more of the following measures:

- Reorient or relocate the receiving antenna.
- Increase the separation between the equipment and the receiver.
- Connect the equipment into an outlet on a circuit different from that to which the receiver is connected.
- Consult the dealer or an experienced radio/TV technician for help.

U.S.A. ONLY

Declaration of Conformity

SHARP LCD PROJECTOR, MODEL XV-Z7000U

This device complies with Part 15 of the FCC rules. Operation is subject to the following conditions: (1) This device may not cause harmful interference, and (2) this device must accept any interference received, including interference that may cause undesired operation.

Responsible Party:

SHARP ELECTRONICS CORPORATION
 Sharp Plaza, Mahwah, New Jersey 07430
 TEL: 1-800-BE-SHARP (1-800-237-4277)

U.S.A. ONLY

WARNING:

The cooling fan in this projector continues to run for about 90 seconds after the projector is turned off. During normal operation, when turning the power off always use the **ON/OFF** button on the projector or the **POWER** button on the remote control. Ensure the cooling fan has stopped before disconnecting the power cord. **DURING NORMAL OPERATION, NEVER TURN THE PROJECTOR OFF BY DISCONNECTING THE POWER CORD. FAILURE TO OBSERVE THIS WILL RESULT IN PREMATURE LAMP FAILURE.**

Caution Concerning the Lamp Replacement

See "Replacing the Projection Lamp" on pages 38 and 39.

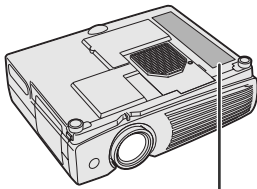

! LAMP REPLACEMENT CAUTION

BEFORE REMOVING THE SCREW, DISCONNECT POWER CORD. HOT SURFACE INSIDE. ALLOW 1 HOUR TO COOL BEFORE REPLACING THE LAMP. REPLACE WITH SAME SHARP LAMP UNIT TYPE BQC-PGC20X//1 ONLY. UV RADIATION: CAN CAUSE EYE DAMAGE. TURN OFF LAMP BEFORE SERVICING. MEDIUM PRESSURE LAMP: RISK OF EXPLOSION. POTENTIAL HAZARD OF GLASS PARTICLES IF LAMP HAS RUPTURED. HANDLE WITH CARE. SEE OPERATION MANUAL.

! PRECAUTIONS A OBSERVER LORS DU REMPLACEMENT DE LA LAMPE.

DEBRANCHER LE CORDON D'ALIMENTATION AVANT DE RETIRER LES VIS. L'INTERIEUR DU BOITIER ETANT EXTREMEMENT CHAUD, ATTENDRE 1 HEURE AVANT DE PROCEDER AU REMPLACEMENT DE LA LAMPE. NE REMPLACER QUE PAR UNE LAMPE SHARP DE TYPE BQC-PGC20X//1. RAYONS ULTRAVIOLETS: PEUVENT ENDOMMAGER LES YEUX. ETEINDRE LA LAMPE AVANT DE PROCEDER A L'ENTRETIEN. LAMPE A MOYENNE PRESSION: RISQUE D'EXPLOSION. DANGER POTENTIEL DE PARTICULES DE VERRE EN CAS D'ECLATEMENT DE LA LAMPE. A MANIPULER AVEC PRECAUTION, SE REPORTER AU MODE D'EMPLOI.

USER SERVICE SCREW
 VIS POUR ENTRETIEN PAR L'UTILISATEUR ↓



IMPORTANT SAFEGUARDS



Electrical energy can perform many useful functions. This product has been engineered and manufactured to ensure your personal safety. However IMPROPER USE CAN RESULT IN POTENTIAL ELECTRICAL SHOCK OR FIRE HAZARD. In order not to defeat the safeguards incorporated into this LCD Projector, observe the following basic rules for its installation, use and servicing. For your own protection and reliable usage of your LCD Projector, please be sure to read these "IMPORTANT SAFEGUARDS" carefully before use.

1. Read Instructions

All the safety and operating instructions should be read before the product is operated.

2. Retain Instructions

The safety and operating instructions should be retained for future reference.

3. Heed Warnings

All warnings on the product and in the operating instructions should be adhered to.

4. Follow Instructions

All operating and use instructions should be followed.

5. Cleaning

Unplug this product from the wall outlet before cleaning. Do not use liquid cleaners or aerosol cleaners. Use a damp cloth for cleaning.

6. Attachments

Do not use attachments not recommended by the product manufacturer as they may cause hazards.

7. Water and Moisture

Do not use this product near water—for example, near a bathtub, wash bowl, kitchen sink, or laundry tub; in a wet basement; or near a swimming pool; and the like.

8. Accessories

Do not place this product on an unstable cart, stand, tripod, bracket, or table. The product may fall, causing serious injury to a child or adult, and serious damage to the product. Use only with a cart, stand, tripod, bracket, or table recommended by the manufacturer, or sold with the product. Any mounting of the product should follow the manufacturer's instructions, and should use a mounting accessory recommended by the manufacturer.

9. Transportation

A product and cart combination should be moved with care. Quick stops, excessive force, and uneven surfaces may cause the product and cart combination to overturn.



10. Ventilation

Slots and openings in the cabinet are provided for ventilation to ensure reliable operation of the product and to protect it from overheating. The openings should never be covered or blocked by placing the product on a bed, sofa, rug, or other similar surface. This product should not be placed in a built-in installation such as a bookcase or rack unless proper ventilation is provided or the manufacturer's instructions have been adhered to.

11. Power Sources

This product should be operated only from the type of power source indicated on the marking label. If you are not sure of the type of power supply to your home, consult your product dealer or local power company. For products intended to operate from battery power, or other sources, refer to the operating instructions.

12. Grounding or Polarization

This product is equipped with a three-wire grounding-type plug, a plug having a third (grounding) pin. This plug will only fit into a grounding-type power outlet. This is a safety feature. If you are unable to insert the plug into the outlet, contact your electrician to replace your obsolete outlet. Do not defeat the safety purpose of the grounding-type plug.

13. Power-Cord Protection

Power-supply cords should be routed so that they are not likely to be walked on or pinched by items placed upon or against them, paying particular attention to cords at plugs, convenience receptacles, and the point where they exit from the product.

14. Lightning

For added protection for this product during a lightning storm, or when it is left unattended and unused for long periods of time, unplug it from the wall outlet and disconnect the power cord. This will prevent damage to the product due to lightning and power-line surges.

15. Overloading

Do not overload wall outlets, extension cords, or integral convenience receptacles as this can result in a risk of fire or electric shock.

16. Object and Liquid Entry

Never push objects of any kind into this product through openings as they may touch dangerous voltage points or short-out parts that could result in a fire or electric shock. Never spill liquid of any kind on the product.

17. Servicing

Do not attempt to service this product yourself as opening or removing covers may expose you to dangerous voltage or other hazards. Refer all servicing to qualified service personnel.

18. Damage Requiring Service

Unplug this product from the wall outlet and refer servicing to qualified service personnel under the following conditions:

- If the power-supply cord or plug is damaged.
- If liquid has been spilled, or objects have fallen into the product.
- If the product has been exposed to rain or water.
- If the product does not operate normally by following the operating instructions. Adjust only those controls that are covered by the operating instructions, as an improper adjustment of other controls may result in damage and will often require extensive work by a qualified technician to restore the product to normal operation.
- If the product has been dropped or damaged in any way.
- If the product exhibits a distinct change in performance, this indicates a need for service.

19. Replacement Parts

When replacement parts are required, be sure the service technician has used replacement parts specified by the manufacturer or with the same characteristics as the original part. Unauthorized substitutions may result in fire, electric shock, or other hazards.

20. Safety Check

Upon completion of any service or repairs to this product, ask the service technician to perform safety checks to determine that the product is in proper operating condition.

21. Wall or Ceiling Mounting

This product should be mounted to a wall or ceiling only as recommended by the manufacturer.

22. Heat

This product should be situated away from heat sources such as radiators, heat registers, stoves, or other products (including amplifiers) that produce heat.

Outstanding Features

1. FOR USE WITH DTV

Allows projection of DTV images and 16:9 wide-screen images when connected to a DTV decoder or similar video systems. (Page 11)

2. ADVANCED VIDEO CIRCUITRY

Provides high quality images with minimal dot crawl and cross color noise.

3. 3D DIGITAL UNIFORMITY

Equipped with new 3D digital uniformity technology for a clearer, more uniform image.

4. ACTIVE DIGITAL KEYSTONE CORRECTION

Corrects keystone distortion caused when the projected image is not perpendicular to the screen. This method provides not only horizontal correction, but vertical as well, thus maintaining the original 4:3 aspect ratio and eliminating jag lines. (Page 19)

5. EASY-TO-USE GRAPHICAL USER INTERFACE (GUI)

A multi-color menu system allows for simple image adjustments. (Page 20)

6. NEW PROGRESSIVE MODE AND FILM MODE

Optimizes the image by converting the interlaced signal to the progressive. Useful for displaying slow-moving images or still images. Four modes are available. (Page 25)

7. COLOR TEMPERATURE ADJUSTMENT

The function can be used to adjust the color temperature to suit the type of image input to the projector. (Page 29)

8. GAMMA CORRECTION FUNCTION

The gamma value setting can be adjusted according to the input source for optimal image contrast. (Page 30)

9. WIDESCREEN IMAGES

Allows projection of DVD, DTV and other anamorphic images recorded in widescreen format with a 16:9 aspect ratio. (Page 31)

10. BRIGHTNESS SWITCHOVER FUNCTION

Function with toggle switch to control the quantity of projected light. Select "ON" or "OFF" to decrease or increase brightness, power consumption and fan noise. (Page 33)

11. ANALOG COMPONENT VIDEO INPUT

Utilizes a component video input signal (Y, Pb, Pr). The video signal is input as separate components to provide superior color and image quality.

12. DIRECT COMPUTER COMPATIBILITY

A multi-scan RGB input accepts signals from VGA (640 dots × 480 lines) and Macintosh (from 13") compatible computers without the need for any additional hardware.

For SHARP Assistance (U.S.A. only)

If you encounter any problems during setup or operation of this projector, first take a look at the section "Troubleshooting" on page 40. If this operation manual does not answer your question, please call toll free 1-877-DTV-SHARP (1-877-388-7427) for further assistance. Or, send us an e-mail at lcdsupport@sharpsec.com. Our World Wide Web address is <http://www.sharp-usa.com/>.





Contents

Important Information



Setup & Connections



Operation



Useful Features



Maintenance & Troubleshooting



Appendix



Important Information

IMPORTANT SAFEGUARDS	3
Outstanding Features	4
For SHARP Assistance (U.S.A. only)	4
Contents	5
Usage Guidelines	6
Part Names	7

Setup & Connections

Supplied Accessories	10
Connecting the Projector	11

Operation

Basic Operations	15
Setting up the Screen	17
Using the GUI (Graphical User Interface)	
Menu Screens	20
Selecting the On-screen Display Language ...	23
Selecting the Video Input System Mode (S-VIDEO or VIDEO mode only)	23
Picture Adjustments	24
Adjusting the Picture	24
Selecting the Signal Type	25
Progressive Mode	25
Computer Image Adjustments (INPUT 2 (RGB) mode only)	26
Auto Sync Adjustment	26
Adjusting the Computer Image	27

Useful Features

Freeze Function	28
Adjusting the Color Temperature	29
Gamma Correction	30
Selecting the Picture Display Mode	31
Checking the Input Signal and the Lamp Usage Time	32
Automatic Power Shutoff Function	32
Selecting a Background Image	33
Theater Mode Function	33
Reverse/Invert Image Function	34
Special Mode Adjustment	34

Maintenance & Troubleshooting

Air Filter Maintenance	35
Lamp/Maintenance Indicators	37
Replacing the Projection Lamp	38
Using the Kensington Lock	40
Troubleshooting	40

Appendix

Attaching the Lens Cap	41
Connection Pin Assignments	42
RS-232C Port Specifications	43
Computer Compatibility Chart	45
Specifications	46
Dimensions	47
Glossary	48



Usage Guidelines

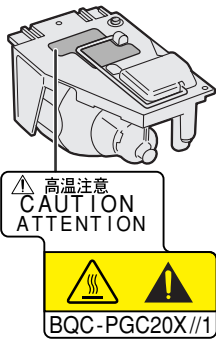

Caution Concerning the Lamp Unit

Potential hazard of glass particles if lamp ruptures. Please have the nearest Authorized SharpVision Service Center or Dealer replace lamp if rupture occurs. See "Replacing the Projection Lamp" on pages 38 and 39.

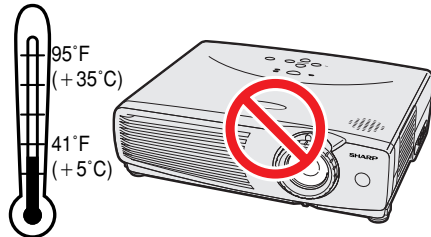

Cautions Concerning the Setup of the Projector

For minimal servicing and to maintain high image quality, SHARP recommends that this projector be installed in an area free from humidity, dust and cigarette smoke. When the projector is subjected to these environments, the lens and filter must be cleaned more often. Periodically the filter should be replaced and the projector should be cleaned internally. As long as the projector is properly maintained in this manner, use in these environments will not reduce the overall operation life. Please note that all internal cleaning must be performed by the nearest Authorized SharpVision Service Center or Dealer.

- Do not expose the projector to extreme heat or cold.
Operating temperature: 41°F to 95°F (+5°C to +35°C)
Storage temperature: -4°F to 140°F (-20°C to +60°C)

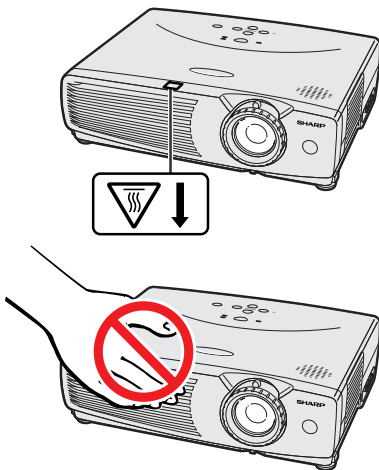

Notes on Operation

- The mark shown on the left calls the user's attention to a part of the projector that emits intense heat during operation.
- The exhaust vent, the lamp cage cover and adjacent areas may be extremely hot during projector operation. To prevent injury, do not touch these areas until they have sufficiently cooled.
- Allow at least 4 inches (10 cm) of space between the cooling fan (exhaust vent) and the nearest wall or obstruction.
- If the cooling fan becomes obstructed, a protection device will automatically turn off the projector lamp. This does not indicate a malfunction. Remove the projector power cord from the wall outlet and wait at least 10 minutes. Then turn on the power by plugging the power cord back in. This will return the projector to the normal operating condition.

Temperature Monitor Function

If the projector starts to overheat due to setup problems or a dirty air filter, "TEMP." will appear in the lower-left corner of the picture. If the temperature continues to rise, the lamp will turn off, the TEMPERATURE WARNING indicator on the projector will flash, and after a 90-second cooling-off period the power will shut off. Refer to "Lamp/Maintenance Indicators" on page 37, for details.

NOTE

- The cooling fan regulates the internal temperature, and its performance is automatically controlled. The sound of the fan may change during projector operation due to changes in the fan speed.



Lamp Monitor Function

When the projector is turned on after the lamp has been used for 900 hours, "LAMP" will appear in the lower-left corner of the picture to advise you to replace the lamp. See pages 38 and 39 for lamp replacement. If the lamp has been used for 1,000 hours, the projector power will automatically turn off and the projector will enter standby mode. Refer to "Lamp/Maintenance Indicators" on page 37, for details.





Part Names

Numbers next to the part names refer to the main pages in this manual where the topic is explained.

Important Information

Projector

Front and Top View

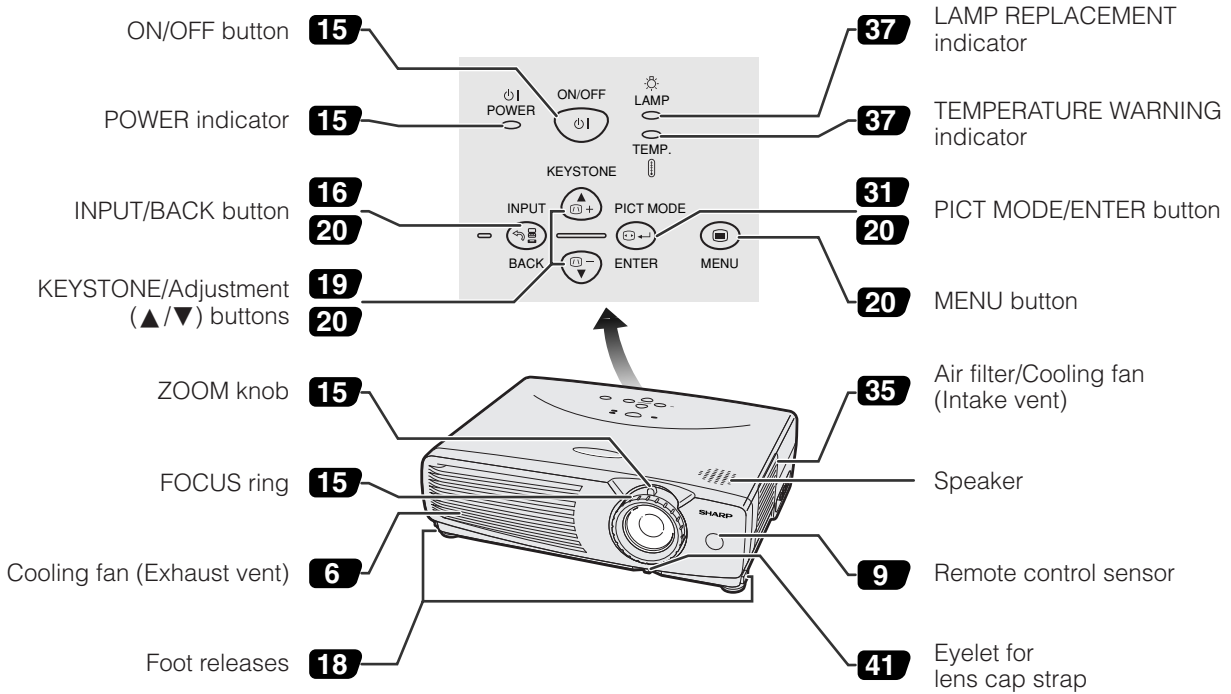

Side and Rear View

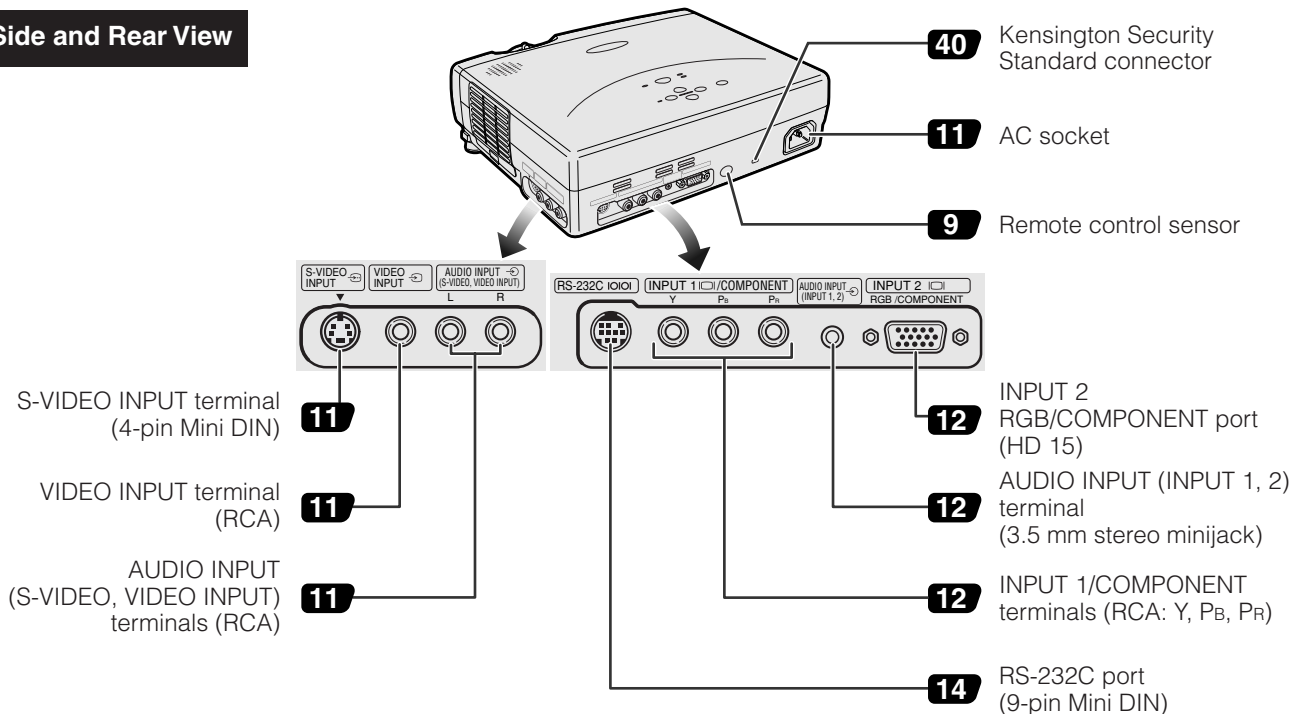



Remote Control

Front View

Top View

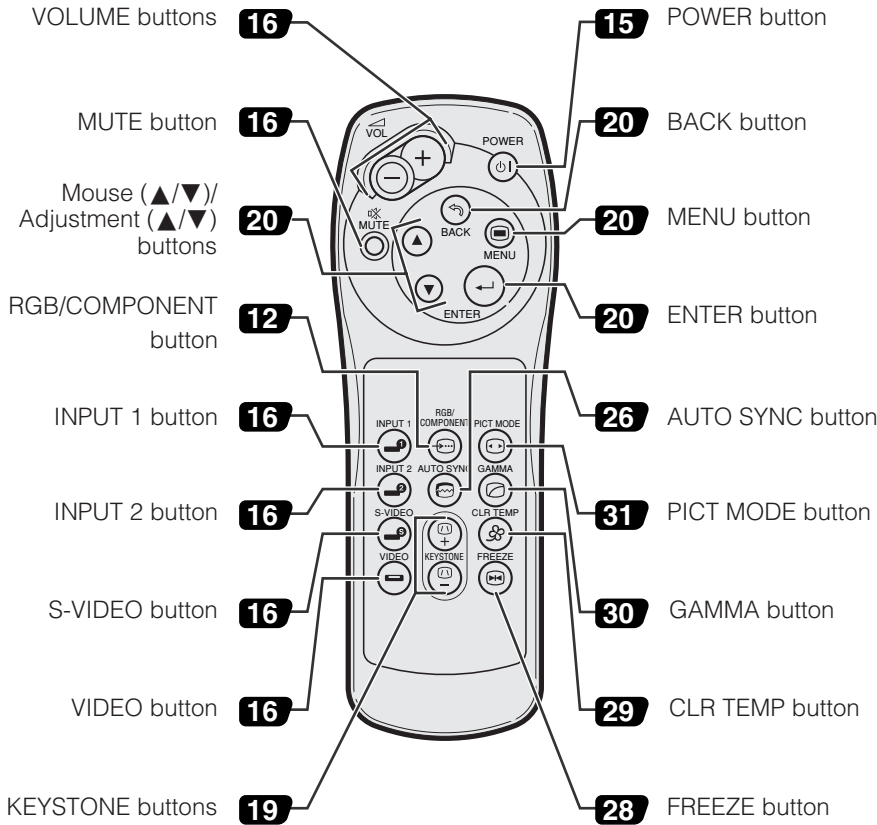

Inserting the Batteries

<p>1 Slide in the direction of the arrow to remove the battery cover.</p>	<p>2 Insert two AAA size batteries, making sure their polarities match the + and - marks inside the battery compartment.</p>	<p>3 Insert the side tabs of the battery cover into their slots and press the cover in until it is properly seated.</p>

NOTE

- If the remote control gets wet, wipe it dry immediately.
- Avoid excessive heat and humidity.
- If you will not be using the remote control for a long time, remove the batteries.
- Do not mix new and old or different types of batteries.
- There are operations that can only be carried out by remote control. Handle the remote control carefully.



Attaching the Rubber Leg Tips

The rubber leg tips are provided to prevent the remote control from skidding and shaking over a flat surface.

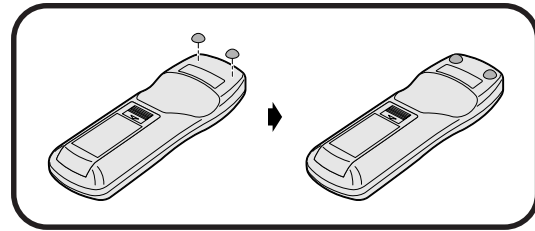

Positioning the Remote Control

The remote control can be used to control the projector within the ranges shown below.

NOTE

- The signal from the remote control can be reflected off a screen for easy operation. However, the effective distance of the signal may differ due to the screen material.

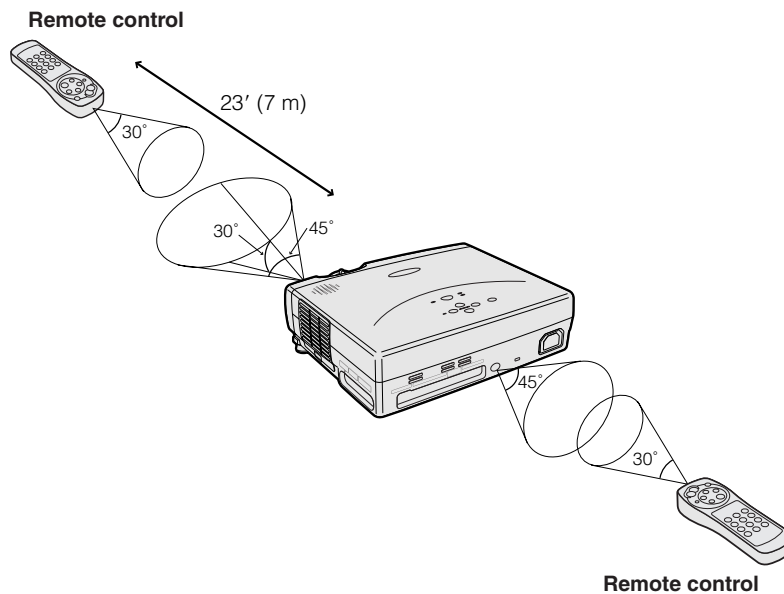



Setup & Connections



Supplied Accessories



Remote control
RRMCG1636CESA



Two AAA size batteries



Rubber leg tips
for remote control
GLEGG9095CEZZ

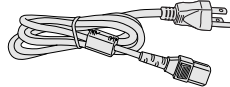

Power cord
CACCU5013DE01

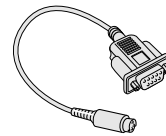

DIN-D-sub RS-232C cable
QCNW-5288CEZZ

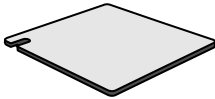

Extra air filter
PFILD0123CEZZ



Lens cap
PCOVZ1095CEKA



Lens cap strap
UBNDT0013CEZZ

LCD projector operation manual
TINS-7273CEZZ



Connecting the Projector

Connecting the Power Cord

Plug the supplied power cord into the AC socket on the back of the projector.

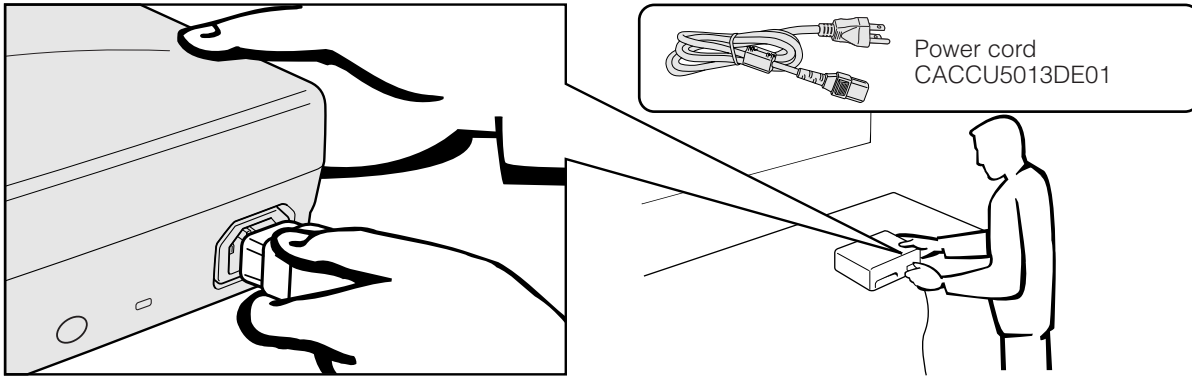

CAUTION

- Make sure you connect the power cord firmly into the AC socket.

Connecting the Projector to Audiovisual Equipment

You can connect your projector to a VCR, laser disc player, DVD player, DTV decoder and other audiovisual equipment.

CAUTION

- Always turn off the projector while connecting to audiovisual equipment, in order to protect both the projector and the equipment being connected.

Connecting a video source (VCR, laser disc player, DTV decoder or DVD player) using the standard video and audio input

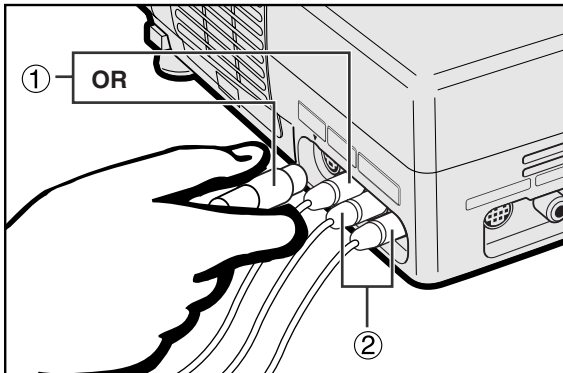

- ① Connect one end of the S-video cable to the **S-VIDEO INPUT** terminal, or one end of the video cable to the **VIDEO INPUT** terminal on the projector and the video output terminal on the video source.
- ② To use the built-in audio system, connect the RCA connectors to the corresponding **AUDIO INPUT (S-VIDEO, VIDEO INPUT)** terminals on the projector and the audio output terminals on the audiovisual source.

The **S-VIDEO INPUT** terminal uses a video signal system in which the picture is separated into a color and a luminance signal to realize a higher-quality image.

NOTE

- For higher quality video, you may use the **S-VIDEO INPUT** terminal on the projector. S-video cable is sold separately.
- If your video equipment does not have an S-video output terminal, use the composite video output terminal.

Projector

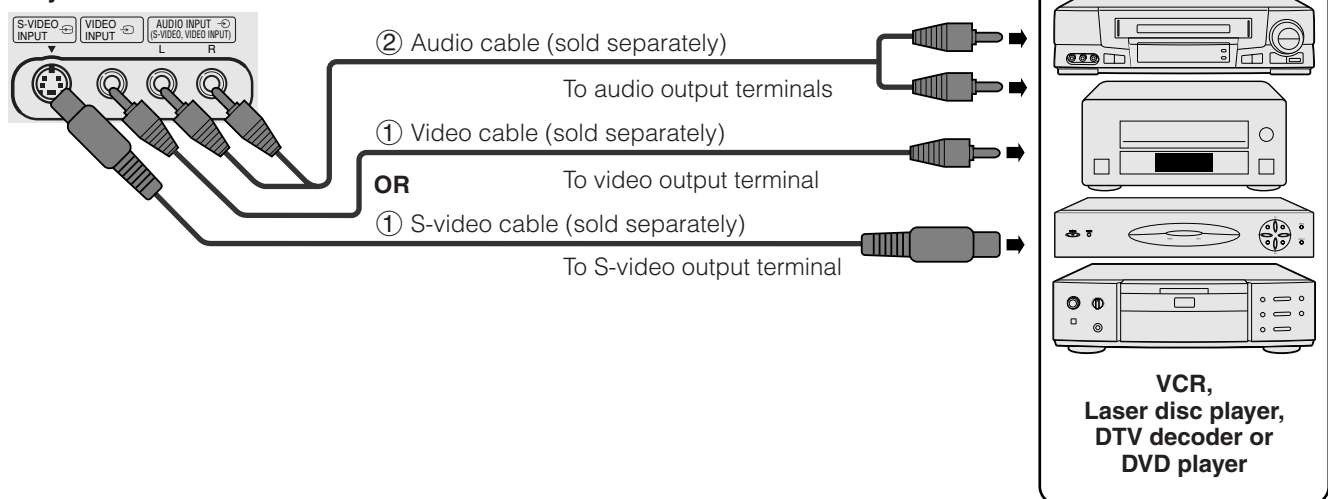



Connecting the Projector

Connecting an audiovisual source (DTV decoder or DVD player) using the RCA input

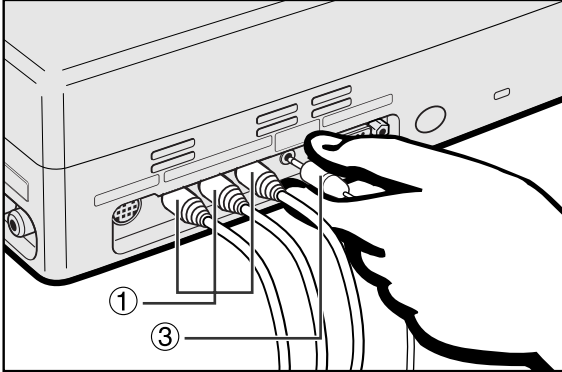

- 1 Connect each RCA connector to the corresponding **INPUT 1/COMPONENT** terminals on the projector.
- 2 Connect the other end of the cable to the corresponding terminals of a DVD player or DTV decoder.
- 3 To use the built-in audio system, connect one end of an audio cable to the **AUDIO INPUT (INPUT 1, 2)** terminal on the projector. Connect the other end to the audio output terminal on the audiovisual equipment.

NOTE

- A 3.5 mm minijack to RCA audio cable adaptor may be necessary.

When connecting this projector to a DVD player or a DTV decoder, select “Component” by using **RGB/COMPONENT** on the remote control or the GUI menu. (See page 25.)

Projector

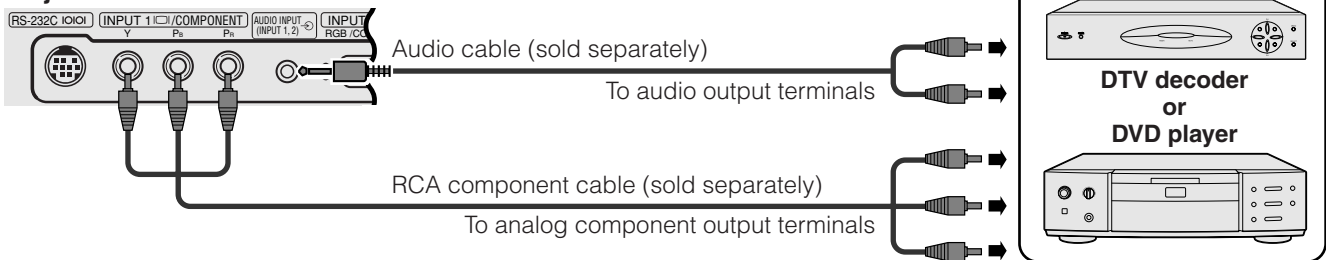

Connecting an audiovisual source (DTV decoder or DVD player) using the 15 pin video and audio input

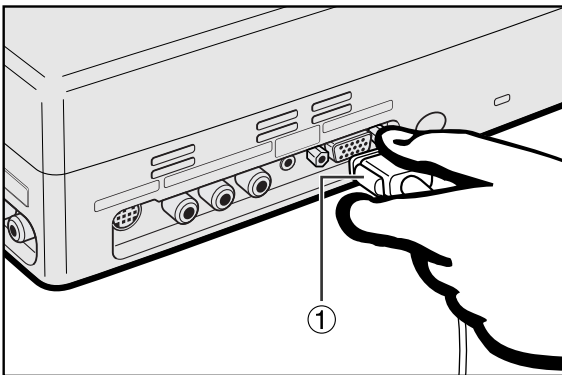

- 1 Connect the one end of the D-sub/RCA cable to the **INPUT 2 RGB/COMPONENT** port on the projector.
- 2 Connect the other end of the cable to the corresponding terminals of a DVD player or DTV decoder.
- 3 To use the built-in audio system, connect one end of an audio cable to the **AUDIO INPUT (INPUT 1, 2)** terminal on the projector. Connect the other end to the audio output terminal on the audiovisual equipment.

NOTE

- A 3.5 mm minijack to RCA audio cable adaptor may be necessary.

When connecting this projector to a DVD player or a DTV decoder, select “Component” by using **RGB/COMPONENT** on the remote control or the GUI menu. (See page 25.)

Projector

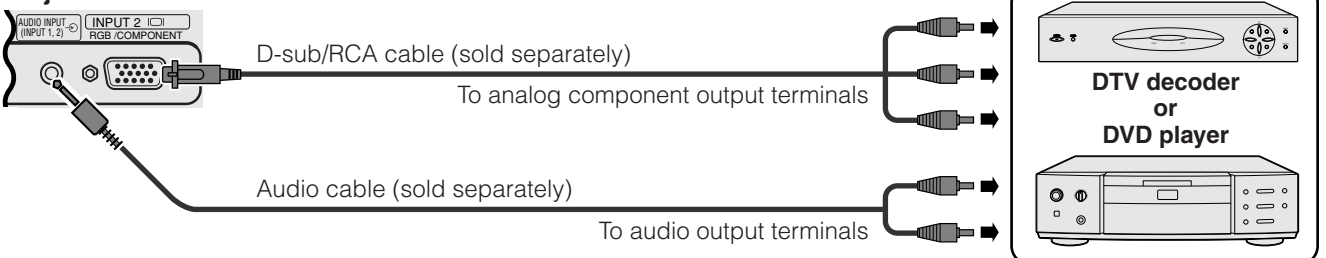



Connecting the Projector to a Computer

You can connect your projector to a computer for projection of full color computer images.

Connecting a computer using the standard 15-pin video and audio input

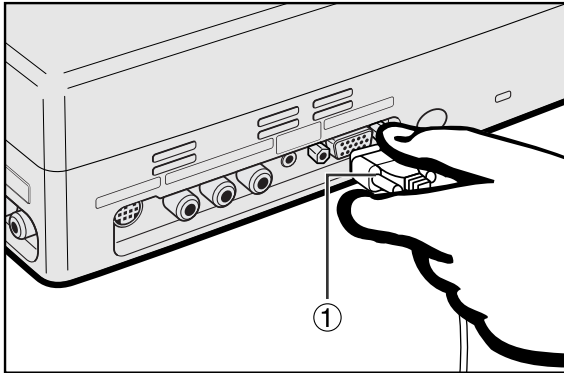

- ① Connect one end of the computer RGB cable to the **INPUT 2 RGB/COMPONENT** port on the projector. Secure the connector by tightening the thumb screws.
- ② Connect the other end to the Monitor output port on the computer. Secure the connector by tightening the thumb screws.
- ③ To use the built-in audio system, connect one end of the computer audio cable to the **AUDIO INPUT (INPUT 1, 2)** terminal on the projector.
- ④ Connect the other end to the Audio output terminal on the computer.

CAUTION

- Before connecting, be sure to turn both the projector and the computer off. After making all connections, turn the projector on first. The computer should always be turned on last.

NOTE

- Please read the computer's operation manual carefully.
- Refer to page 45 "Computer Compatibility Chart" for a list of computer signals compatible with the projector. Use with computer signals other than those listed may cause some of the functions not to work.
- A Macintosh adaptor may be required for use with some Macintosh computers. Contact your nearest Authorized SharpVision Service Center or Dealer.

When connecting this projector to a computer, select "RGB" by using **RGB/COMPONENT** on the remote control or the GUI menu. (See page 25.)

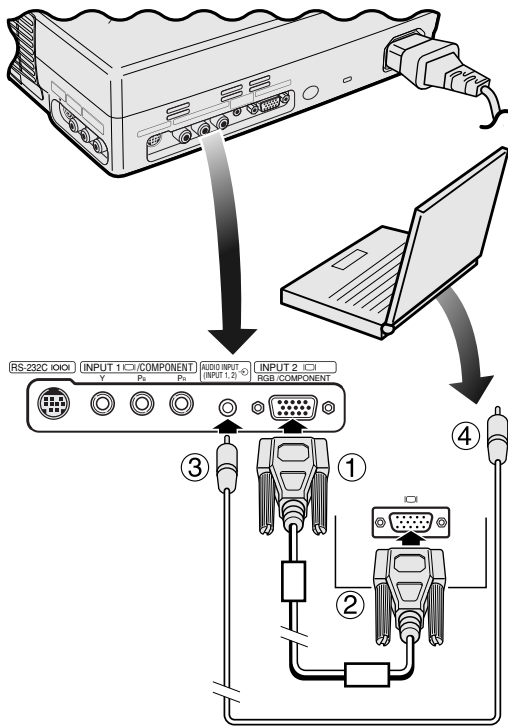

Connecting other compatible computers

When connecting the projector to a compatible computer other than an IBM-PC (VGA/SVGA/XGA/SXGA) or Macintosh (i.e. Workstation), a separate cable may be needed. Please contact your dealer for more information.

When connecting this projector to a computer, select "RGB" by using **RGB/COMPONENT** on the remote control or the GUI menu. (See page 25.)

NOTE

- Connecting computers other than the recommended types may result in damage to the projector, the computer, or both.

"Plug and Play" function

- This projector is compatible with VESA-standard DDC 1/DDC 2B. The projector and a VESA DDC compatible computer will communicate their setting requirements, allowing for quick and easy setup.
- Before using the "Plug and Play" function, be sure to turn on the projector first and the connected computer last.

NOTE

- The DDC, Plug and Play function of this projector operates only when used in conjunction with a VESA DDC compatible computer.



Connecting RS-232C Port

When the RS-232C port on the projector is connected to a computer with an RS-232C cable (null modem, cross type, sold separately), the computer can be used to control the projector and check the status of the projector. See pages 43 and 44 for details.

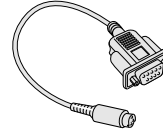

DIN-D-sub RS-232C
cable
QCNW-5288CEZZ

- ① Connect the supplied DIN-D-sub RS-232C cable to the RS-232C port on the projector.
- ② Connect an RS-232C cable (null modem, cross type, sold separately) to the other end of DIN-D-sub RS-232C cable and to the serial port on the computer.

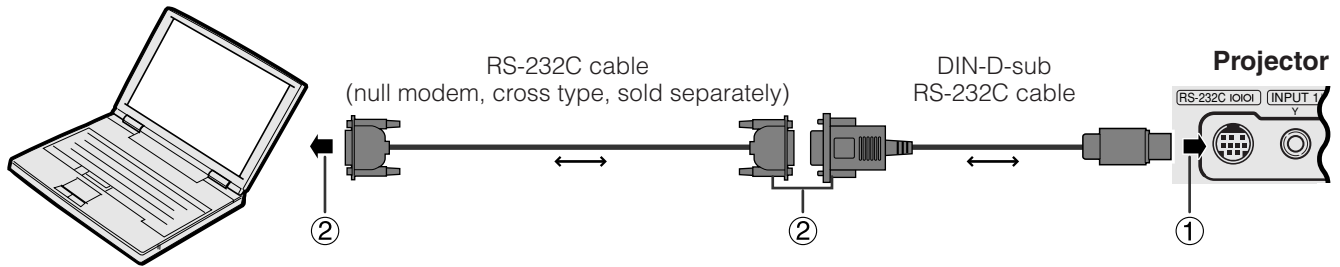

CAUTION

- Do not connect or disconnect an RS-232C cable to or from the computer while it is on. This may damage your computer.

NOTE

- The RS-232C function may not operate if your computer port is not correctly set up. Please refer to the operation manual of the computer for details on setting up.
- A Macintosh adaptor may be required for use with some Macintosh computers. Contact your nearest Authorized SharpVision Service Center or Dealer.





Operation



Basic Operations

Maintenance indicators



Projector

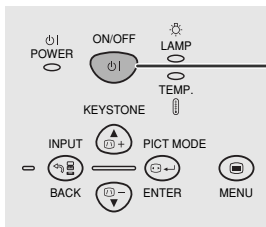

Remote control

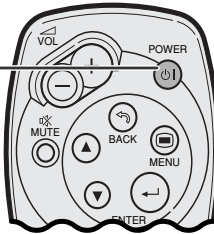

- ① Make the necessary connections before proceeding. Connect the power cord to a wall outlet. The POWER indicator illuminates red and the projector enters standby mode.

NOTE

- If the side filter cover is not securely installed, the POWER indicator flashes.

- ② Press **ON/OFF** on the projector for over one second, or **POWER** on the remote control.

NOTE

- The flashing green LAMP REPLACEMENT indicator shows that the lamp is warming up. Wait until the indicator stops flashing before operating the projector.
- If the power is turned off and then immediately turned on again, it may take a short while before the lamp turns on.
- After the projector is unpacked and turned on for the first time, a slight odor may be emitted from the exhaust vent. This odor will soon disappear with use.
- Do not press any buttons before the startup image disappears. Before "Adjusting The Image" appears, only **ON/OFF** or **POWER** is available.

Startup image



Maintenance indicators

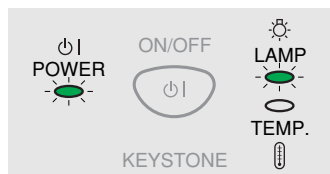

When the power is on, the LAMP REPLACEMENT indicator lights indicating the status of the lamp.

Green: Lamp is ready.

Flashing green: Warming up.

Red: Change the lamp.

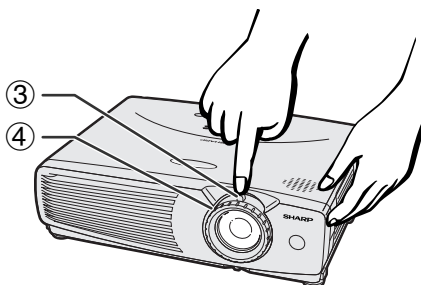

- ③ Slide the ZOOM knob. The image can be adjusted to the desired size within the zoom range.

- ④ Rotate the FOCUS ring until the image on the screen becomes clear.





Basic Operations

Projector

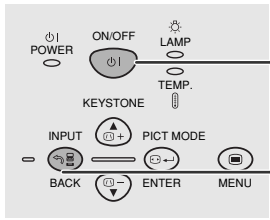

Remote control

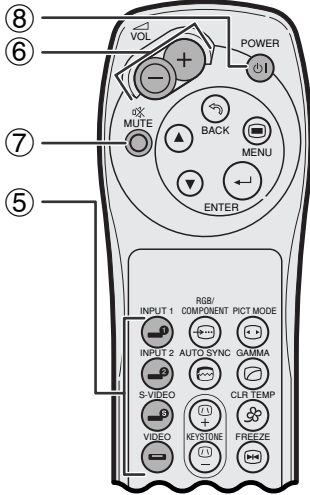

- ⑤ Press **INPUT** on the projector, **INPUT 1**, **INPUT 2**, **S-VIDEO** or **VIDEO** on the remote control to select the desired input mode. Press **INPUT**, **INPUT 1**, **INPUT 2**, **S-VIDEO** or **VIDEO** again to change the mode.

NOTE

- When the selected input signal is being received, "Adjusting The Image" will be displayed.
- When no signal is being received, "NO SIGNAL" will be displayed. When a signal that the projector is not preset to receive is being received, "NOT REG." will be displayed.

- ⑥ Press **VOLUME** on the remote control to adjust the volume.

- ⑦ Press **MUTE** on the remote control to temporarily turn off the sound. Press **MUTE** again to turn the sound back on.

- ⑧ Press **ON/OFF** on the projector for over one second, or **POWER** on the remote control. Press **ON/OFF** or **POWER** again while the message is displayed.

EXAMPLE

- ⑤ **INPUT 1 Mode**

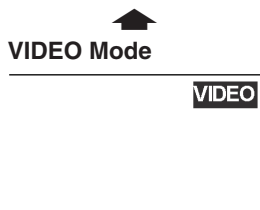
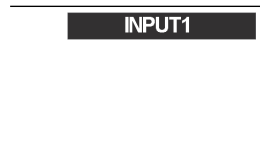

INPUT 2 Mode

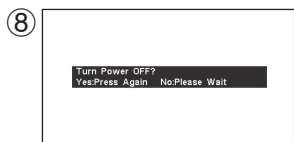
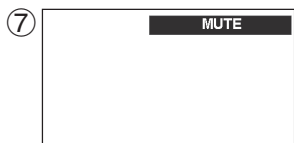
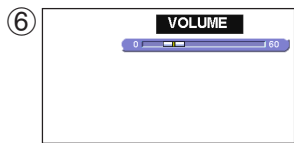
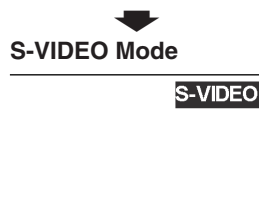

NOTE

- If you accidentally pressed **ON/OFF** or **POWER** and do not want to turn off the power, wait until the power off screen disappears.
- When **ON/OFF** or **POWER** is pressed twice, the POWER indicator will light up red and the cooling fan will run for about 90 seconds. The projector will then enter standby mode.
- Wait until the cooling fan stops before disconnecting the power cord.
- The power can be turned on again by pressing **ON/OFF** or **POWER**. When the power is turned on, the POWER indicator and the LAMP REPLACEMENT indicator light green.
- The POWER indicator flashes if the right side filter cover is not securely installed.

WARNING:

The cooling fan in this projector continues to run for about 90 seconds after the projector is turned off. During normal operation, when turning the power off always use the **ON/OFF** button on the projector or the **POWER** button on the remote control. Ensure the cooling fan has stopped before disconnecting the power cord. **DURING NORMAL OPERATION, NEVER TURN THE PROJECTOR OFF BY DISCONNECTING THE POWER CORD. FAILURE TO OBSERVE THIS WILL RESULT IN PREMATURE LAMP FAILURE.**





Setting up the Screen

Position the projector perpendicular to the screen with all feet flat and level to achieve an optimal image. Move the projector forward or backward if the edges of the image are distorted.

NOTE

- The projector lens should be centered in the middle of the screen. If the lens center is not perpendicular to the screen, the image will be distorted, making viewing difficult.
- Position the screen so that it is not in direct sunlight or room light. Light falling directly onto the screen washes out colors, making viewing difficult. Close the curtains and dim the lights when setting up the screen in a sunny or bright room.
- A polarizing screen cannot be used with this projector.

Standard Setup (Front Projection)

Place the projector at the required distance from the screen according to the desired picture size. (See the table below.)

FULL Mode (4:3)

Picture size			Projection distance (L)		Distance from the lens center to the bottom of the image (H)
Diag. (x)	Width	Height	Maximum (L ₁)	Minimum (L ₂)	
250"	200"	150"	32' 10" (10.0 m)*1	32' 7" (9.9 m)	15" (38.1 cm)
200"	160"	120"	31' 5" (9.6 m)	26' 7" (7.9 m)	12" (30.5 cm)
150"	120"	90"	23' 6" (7.2 m)	19' 6" (5.9 m)	9" (22.9 cm)
100"	80"	60"	15' 7" (4.8 m)	12' 11" (3.9 m)	6" (15.2 cm)
84"	67"	50"	13' 1" (4.0 m)	10' 10" (3.3 m)	5 1/32" (12.8 cm)
72"	58"	43"	11' 2" (3.4 m)	9' 3" (2.8 m)	4 5/16" (11.0 cm)
60"	48"	36"	9' 4" (2.8 m)	7' 8" (2.3 m)	3 19/32" (9.1 cm)
40"	32"	24"	6' 2" (1.9 m)	5' 1" (1.6 m)	2 13/32" (6.1 cm)

The formula for picture size and projection distance

$$L_1 \text{ (feet)} = (0.0481x - 0.0447) \times 3.28$$

$$L_2 \text{ (feet)} = (0.0399x - 0.0447) \times 3.28$$

$$H \text{ (inches)} = 0.06x$$

WIDE Mode (16:9)

Picture size			Projection distance (L)		Distance from the lens center to the bottom of the image (H)
Diag. (x)	Width	Height	Maximum (L ₁)	Minimum (L ₂)	
225"	196"	110"	32' 10" (10.0 m)*2	32' 0" (9.8 m)	- 3 43/64" (-9.3 cm)
200"	174"	98"	32' 10" (10.0 m)*3	28' 5" (8.7 m)	- 3 17/64" (-8.3 cm)
150"	131"	74"	25' 7" (7.8 m)	21' 3" (6.5 m)	- 2 29/64" (-6.2 cm)
133"	116"	65"	22' 8" (6.9 m)	18' 10" (5.7 m)	- 2 11/64" (-5.5 cm)
106"	92"	52"	18' 1" (5.5 m)	14' 12" (4.6 m)	- 1 47/64" (-4.4 cm)
100"	87"	49"	17' (5.2 m)	14' 1" (4.3 m)	- 1 41/64" (-4.2 cm)
92"	80"	45"	15' 8" (4.8 m)	12' 12" (4.0 m)	- 1 1/2" (-3.8 cm)
84"	73"	41"	14' 3" (4.4 m)	11' 10" (3.6 m)	- 1 3/8" (-3.5 cm)
72"	63"	35"	12' 3" (3.7 m)	10' 1" (3.1 m)	- 1 11/64" (-3.0 cm)
60"	52"	29"	10' 2" (3.1 m)	8' 5" (2.6 m)	- 63/64" (-2.5 cm)
40"	35"	20"	6' 9" (2.0 m)	5' 7" (1.7 m)	- 21/32" (-1.7 cm)

The formula for picture size and projection distance

$$L_1 \text{ (feet)} = (0.0524x - 0.0447) \times 3.28$$

$$L_2 \text{ (feet)} = (0.0436x - 0.0447) \times 3.28$$

$$H \text{ (inches)} = -0.0163x$$

NORMAL Mode (4:3)

Picture size			Projection distance (L)		Distance from the lens center to the bottom of the image (H)
Diag. (x)	Width	Height	Maximum (L ₁)	Minimum (L ₂)	
180"	144"	108"	32' 10" (10.0 m)*4	31' 3" (9.5 m)	- 3 19/32" (-9.1 cm)
150"	120"	90"	31' 4" (9.6 m)	25' 12" (7.9 m)	- 3" (-7.6 cm)
100"	80"	60"	20' 10" (6.3 m)	17' 3" (5.3 m)	- 2" (-5.1 cm)
84"	67"	50"	17' 6" (5.3 m)	14' 6" (4.4 m)	- 1 11/16" (-4.3 cm)
72"	58"	43"	14' 11" (4.6 m)	12' 4" (3.8 m)	- 1 7/16" (-3.7 cm)
60"	48"	36"	12' 5" (3.8 m)	10' 3" (3.1 m)	- 1 3/16" (-3.0 cm)
40"	32"	24"	8' 3" (2.5 m)	6' 9" (2.1 m)	- 13/16" (-2.0 cm)

The formula for picture size and projection distance

$$L_1 \text{ (feet)} = (0.0641x - 0.0447) \times 3.28$$

$$L_2 \text{ (feet)} = (0.0532x - 0.0447) \times 3.28$$

$$H \text{ (inches)} = -0.02x$$

x : Picture size (diag.) (inches)

L₁: Maximum projection distance (feet)

L₂: Minimum projection distance (feet)

H: Distance from the lens center to the bottom of the image (inches)

NOTE

- There are errors of ±3% in the formulas above.
- Values with a minus (-) sign indicate the distance of the lens center below the bottom of the screen.
- The values do not match up when applying the formula in *1 to *4 above. However, this is not a calculation error.
- For optimum focus, the recommended projection distance (L) is from 3' 9" (1.15m) to 32' 10" (10.0m).





Setting up the Screen

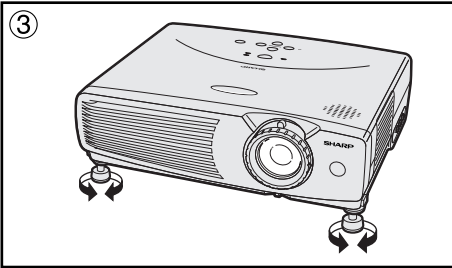
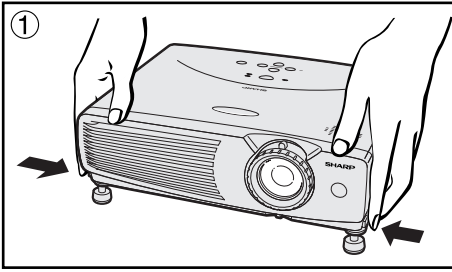

Using the Adjustment Feet

You can adjust the height of the image by raising the projector with the foot releases.

- ① Press the foot releases and lift the projector to the desired angle. (Adjustable up to approximately 7° from the standard position.)
- ② Remove your hands from the foot releases. Once the adjustment feet have locked in position, release the projector.
- ③ If the screen is at an angle, the adjusters can be used to adjust the angle of the image.

Returning the projector to its original position

While holding the projector, press the foot releases and slowly lower the projector to its original position.

NOTE

- When an adjustment is made, the image may become distorted (keystoned), depending on the relative positions of the projector and the screen.

CAUTION

- Do not press the foot releases when the adjustment feet are extended without firmly holding the projector.
- Do not hold the lens when lifting or lowering the projector.
- When lowering the projector, be careful not to get your fingers caught in the area between the adjustment feet and the projector.

Reversed Image Setup

Rear projection

- Place a translucent screen between the projector and the audience.
- Use the projector's menu system to reverse the projected image. (See page 34 for use of this function.)

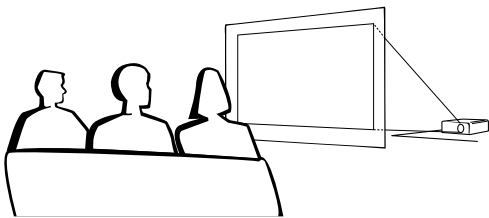

NOTE

- Optimal image quality can be achieved when the projector is positioned perpendicular to the screen with all feet flat and level.

CAUTION

- When using a mirror, be sure to carefully position both the projector and the mirror so the light does not shine into the eyes of the audience.

Projection using a mirror

- When the distance between the projector and screen is not sufficient for normal rear projection, you can use a mirror to reflect the image onto the screen.
- Place a mirror (normal flat type) in front of the lens.
- Project the normal image onto the mirror.
- The image reflected from the mirror is projected onto the translucent screen.

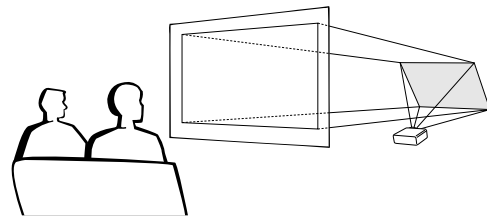

Ceiling-mount Setup

- It is recommended that you use the optional Sharp ceiling-mount bracket for this installation.
- Before mounting the projector, contact your nearest Authorized SharpVision Dealer or Servicer to obtain the recommended ceiling-mount bracket and hardware (sold separately). (AN-CM240 ceiling-mount bracket, AN-EP101AP extension tube for AN-CM240 and AN-PGCM80 ceiling adapter for AN-CM240.)
- When the projector is in the inverted position, use the upper edge of the screen as the base line.
- Use the projector's menu system to select the appropriate projection mode. (See page 34 for use of this function.)

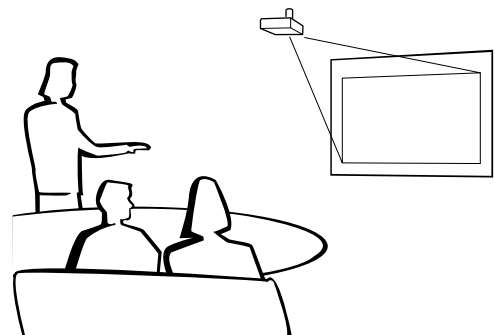



Setting up the Screen

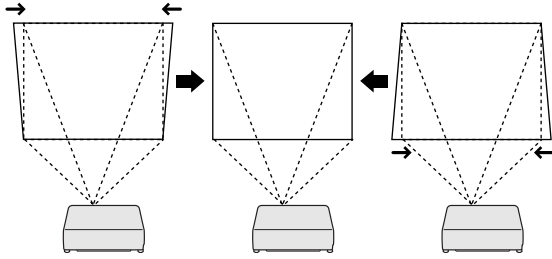

Projector

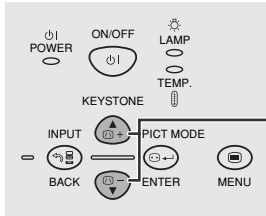

Remote control

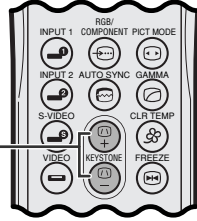

Digital Keystone Correction

- When the image is distorted due to the projection angle, the digital keystone correction function allows you to correct it.
- The digital keystone correction can be made by pressing **KEYSTONE**, or by setting “Keystone” correction in the GUI menu.

Using the KEYSTONE buttons

- 1 Press **KEYSTONE** to adjust the setting.

Projector

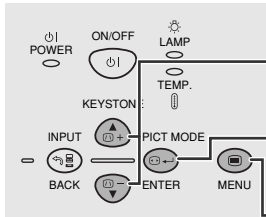

Remote control

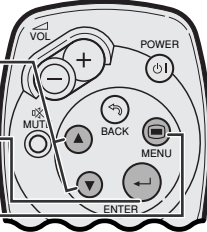

Using the GUI menu

- 1 Press **MENU**.
- 2 Press **▲/▼** to select “Options”, and then press **ENTER**.
- 3 Press **▲/▼** to select “Keystone”, and then press **ENTER**.
- 4 Press **▲/▼** to move the  mark to the desired setting.
- 5 To exit from the GUI, press **MENU**.

(GUI) On-screen Display

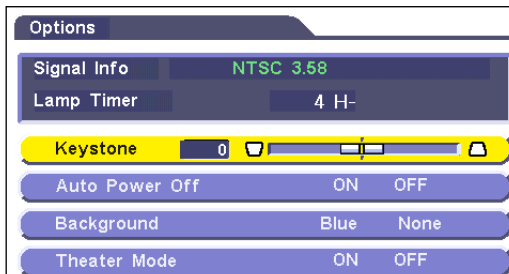

NOTE

- To reset the keystone setting, press **BACK**.
- Straight lines and the edges of the displayed image may appear jagged, when adjusting the keystone setting.



Using the GUI (Graphical User Interface) Menu Screens

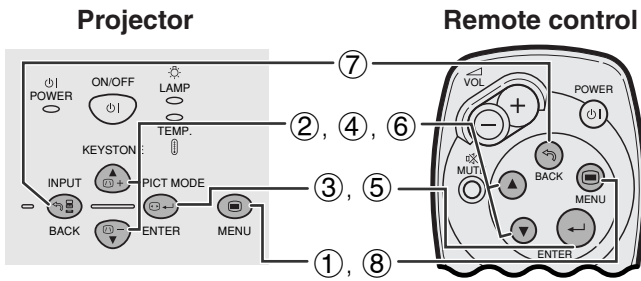

This projector has three sets of menu screens (INPUT 1 or 2 (COMPONENT), INPUT 2 (RGB) and S-VIDEO or VIDEO) that allow you to adjust the image and various projector settings. These menu screens can be operated from the projector or the remote control with the following buttons.

(GUI) On-screen Display

EXAMPLE

INPUT 1 or 2 (COMPONENT) mode

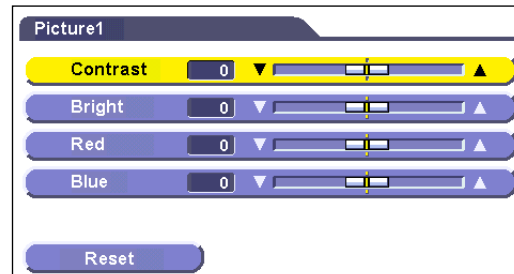
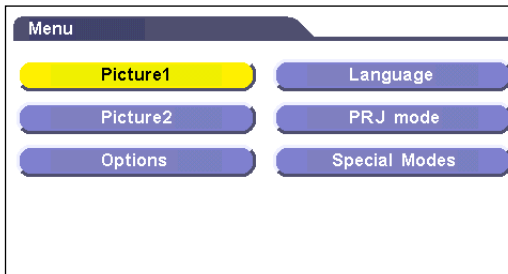

INPUT 2 (RGB) mode

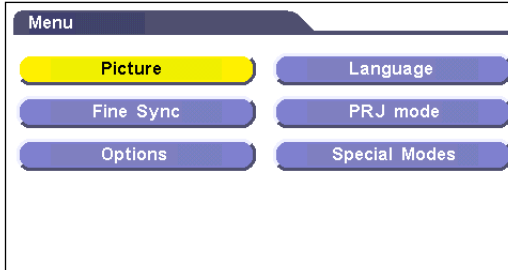

S-VIDEO or VIDEO mode

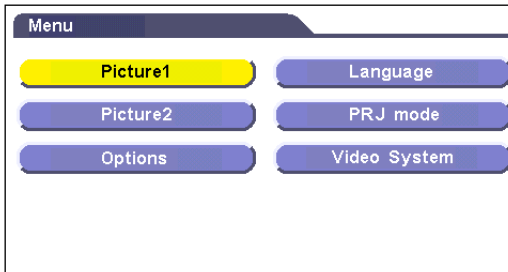

- ① Press **MENU** to display the main menu.
- ② Press **▲/▼** to select an adjustment item in the main menu.
- ③ Press **ENTER** to display the sub menu.
- ④ Press **▲/▼** to select an adjustment item in the sub menu.
- ⑤ Press **ENTER** to activate the selected adjustment item.
- ⑥ Press **▲/▼** to adjust the item.
- ⑦ Press **BACK** to return to the previous screen.
- ⑧ Press **MENU** to exit from the GUI.

NOTE

- For details on items on the menu screen, see the tree charts on pages 21 and 22.





Items on the INPUT 1 or 2 (COMPONENT) Mode Menu Bar

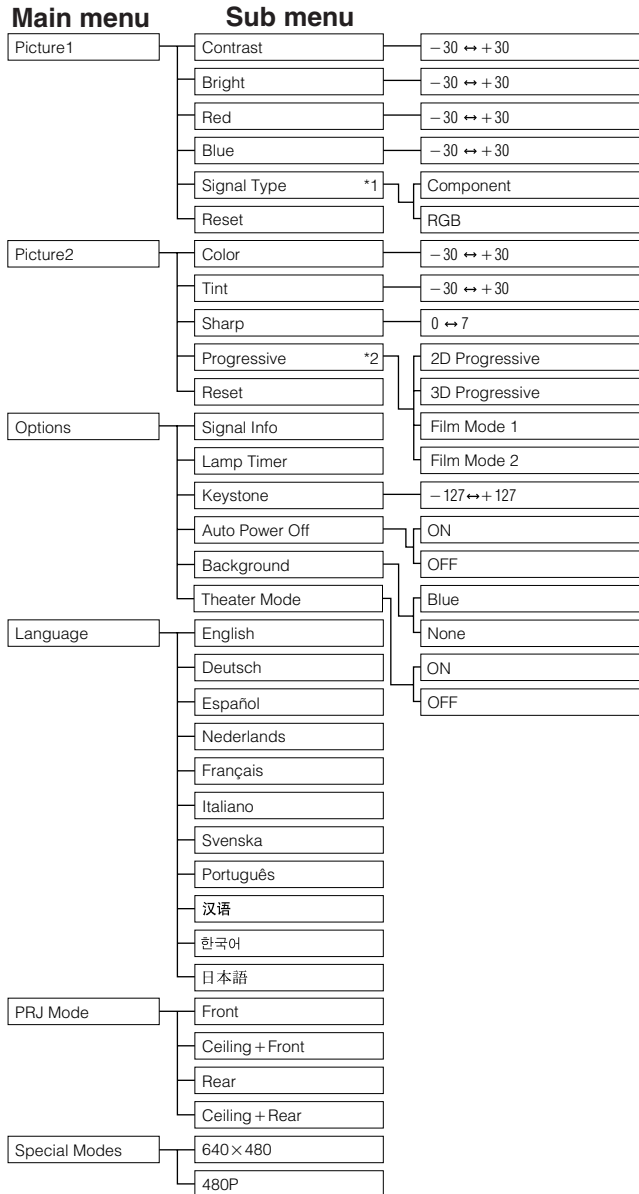

Items on the INPUT 2 (RGB) Mode Menu Bar

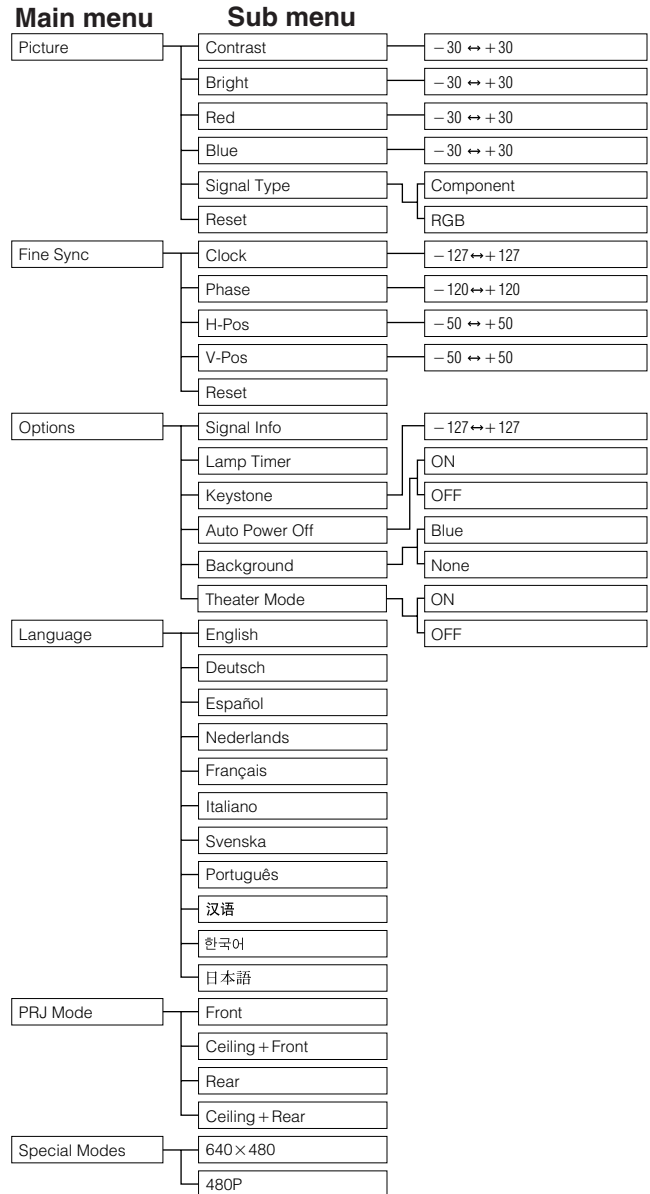

NOTE

- *1 "Signal Type" does not appear when the INPUT 1 (COMPONENT) mode is selected.
- *2 "Progressive" only appears when receiving a 480i signal in the INPUT 2 (COMPONENT) mode.
- "Color", "Tint" and "Sharp" do not appear in the INPUT 2 (RGB) mode.





Items on the S-VIDEO or VIDEO Mode Menu Bar

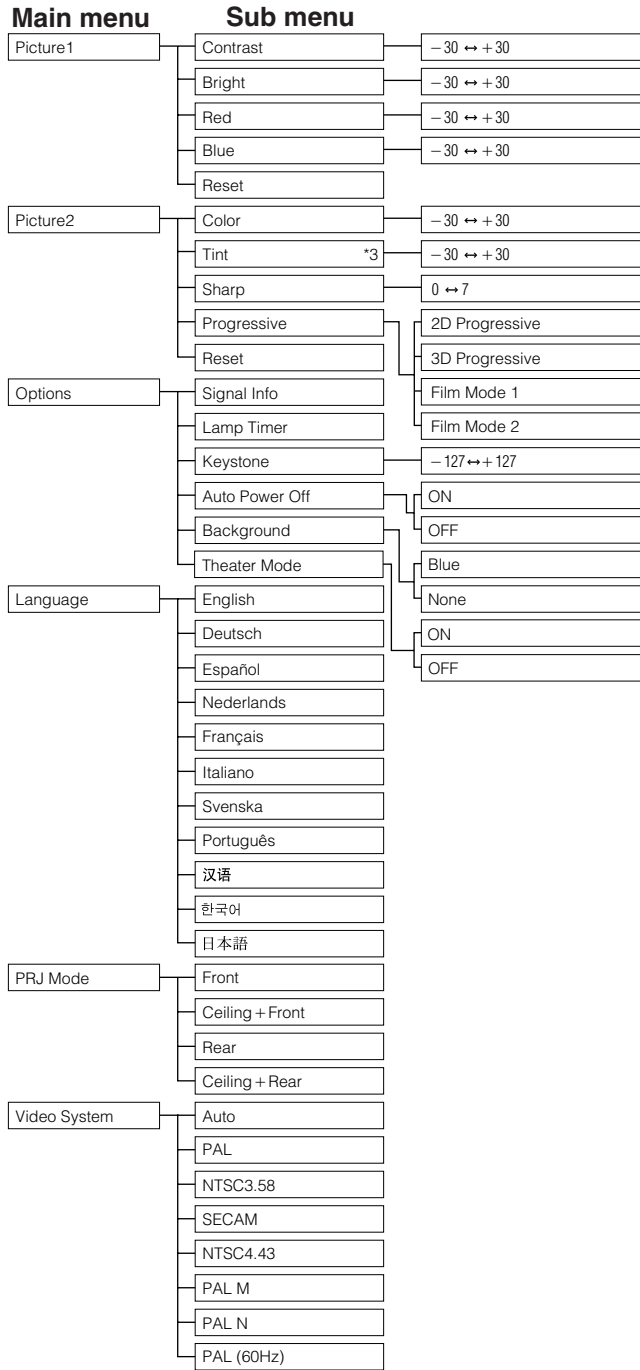

NOTE

*3 "Tint" does not appear when receiving "PAL", "SECAM", "PAL M", "PAL N" or "PAL (60Hz)" in the S-VIDEO or VIDEO mode.





Selecting the On-screen Display Language

Projector

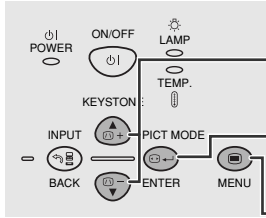

Remote control

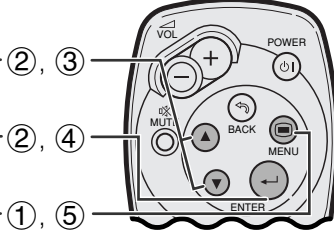

English is the preset language for the On-screen Display. The language can be set to English, German, Spanish, Dutch, French, Italian, Swedish, Portuguese, Chinese, Korean or Japanese.

- ① Press **MENU**.
- ② Press **▲/▼** to select "Language", and then press **ENTER**.
- ③ Press **▲/▼** to select the desired language.
- ④ Press **ENTER** to save the setting. The On-screen Display is now programmed to display in the language selected.
- ⑤ To exit from the GUI, press **MENU**.

(GUI) On-screen Display



Selecting the Video Input System Mode (S-VIDEO or VIDEO mode only)

Projector

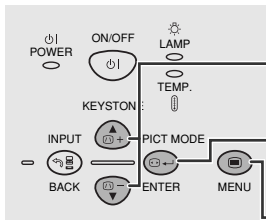

Remote control

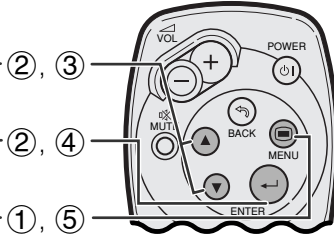

The video input system mode is preset to "Auto"; however, it can be changed to a specific system mode, if the selected system mode is not compatible with the connected audiovisual equipment.

- ① Press **MENU**.
- ② Press **▲/▼** to select "Video System", and then press **ENTER**.
- ③ Press **▲/▼** to select the desired video system mode.
- ④ Press **ENTER** to save the setting.
- ⑤ To exit from the GUI, press **MENU**.

(GUI) On-screen Display

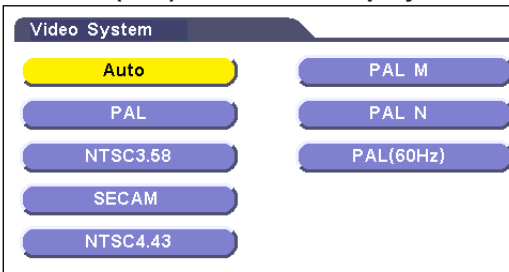

NOTE

- When the system mode is set to "Auto", you may not receive a clear picture due to signal differences. Should this occur, switch to the video system of the source signal.



Picture Adjustments

Projector

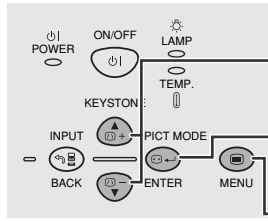

Remote control

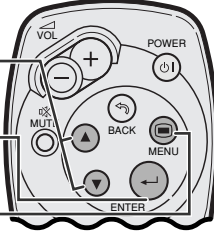

(GUI) On-screen Display INPUT 1 or 2 (COMPONENT) mode

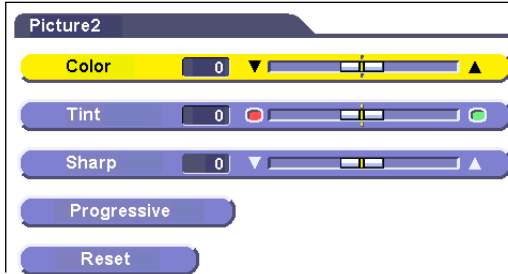

INPUT 2 (RGB) mode

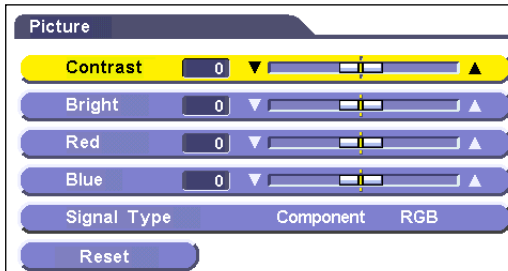

S-VIDEO or VIDEO mode

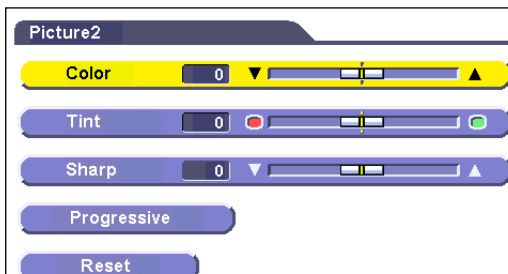
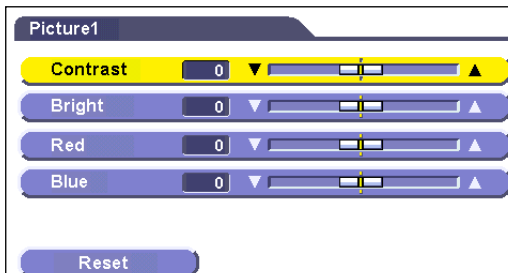

Adjusting the Picture

You can adjust the projector's picture to your preferences with the following picture settings.

Description of Adjustment Items

Selected item	▼ button	▲ button
Contrast	For less contrast	For more contrast
Bright	For less brightness	For more brightness
Red	For weaker red	For stronger red
Blue	For weaker blue	For stronger blue
Reset	All image adjustment items are returned to the factory preset settings.	
Color	For less color intensity	For more color intensity
Tint	Skin tones become purplish	Skin tones become greenish
Sharp	For less sharpness	For more sharpness

NOTE

- "Signal Type" does not appear when the INPUT 1 (COMPONENT) mode is selected.
- "Progressive" only appears when receiving a 480i signal in the INPUT 2 (COMPONENT) mode.
- "Color", "Tint" and "Sharp" do not appear in the INPUT 2 (RGB) mode.
- "Tint" does not appear when receiving "PAL", "SECAM", "PAL M", "PAL N" or "PAL (60Hz)" in the S-VIDEO or VIDEO mode.

- 1 Press **MENU**.
- 2 Press ▲/▼ to select "Picture1" or "Picture2" in INPUT 1 or 2 (COMPONENT), S-VIDEO or VIDEO mode, or to select "Picture" in INPUT 2 (RGB) mode, and then press **ENTER**.
- 3 Press ▲/▼ to select a specific adjustment item, and then press **ENTER**.
- 4 Press ▲/▼ to move the  mark of the selected adjustment item to the desired setting.
- 5 To exit from the GUI, press **MENU**.

NOTE

- To reset all adjustment items, select "Reset", and then press **ENTER**.
- The adjustments can be stored separately in the INPUT 1, INPUT 2, S-VIDEO and VIDEO modes.





Picture Adjustments

Projector

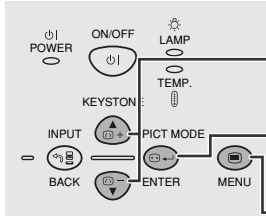

Remote Control

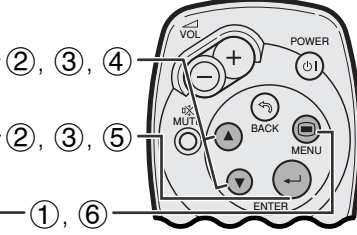

Selecting the Signal Type

This function allows you to select the input signal type (RGB or COMPONENT) for INPUT 2 port.

- ① Press **MENU**.
- ② Press **▲/▼** to select "Picture" in INPUT 2 (RGB) mode, and then press **ENTER**.
- ③ Press **▲/▼** to select "Signal Type", and then press **ENTER**.
- ④ Press **▲/▼** to select "Component" or "RGB".
- ⑤ Press **ENTER** to save the setting.
- ⑥ To exit from the GUI, press **MENU**.

(GUI) On-screen Display

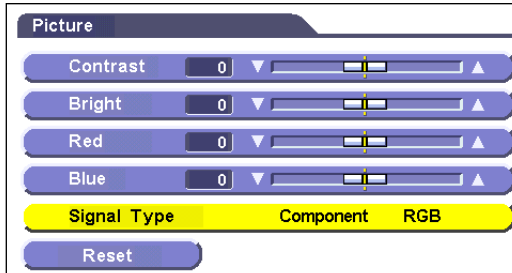

Progressive Mode

This function allows you to select the progressive display of a video signal. The progressive display projects a smoother video image. For reducing distortion and noise, select an item in "Progressive" for optimum image quality.

Projector

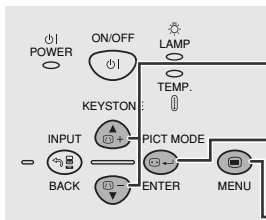

Remote Control

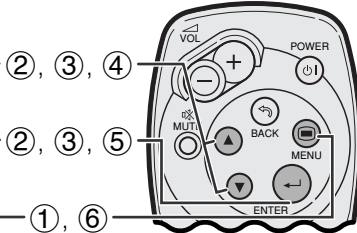

- ① Press **MENU**.
- ② Press **▲/▼** to select "Picture2" in S-VIDEO or VIDEO mode, and then press **ENTER**.
- ③ Press **▲/▼** to select "Progressive", and then press **ENTER**.
- ④ Press **▲/▼** to select the desired progressive display.
- ⑤ Press **ENTER** to save the setting.
- ⑥ To exit from the GUI, press **MENU**.

(GUI) On-screen Display

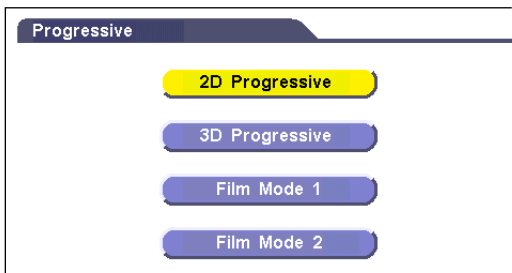

Description of Progressive Modes

2D Progressive

Useful for displaying fast-moving images such as sports and action films. Mode that optimizes the image in a displayed frame.

3D Progressive

Useful for displaying relatively slow-moving images such as drama and documentary more clearly. Mode that optimizes the image by estimating the movement of a number of preceding and succeeding frames.

Film Mode 1

Effective for displaying action movies or other fast-moving film sources.

Film Mode 2

Effective for displaying still images or slow-moving film sources as in a documentary.

NOTE

- The film source is a digital video recording with the original encoded as is at 24 frames/second. The projector can convert this film source to progressive video at 60 frames/second to play back a high-definition image.



Computer Image Adjustments (INPUT 2 (RGB) mode only)

Remote control

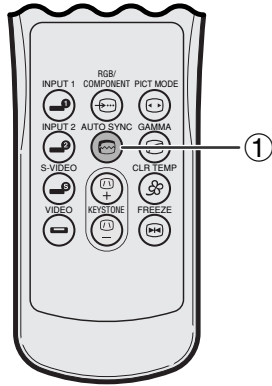

Auto Sync Adjustment

- Used to automatically adjust a computer image.
- Auto Sync adjustment can be made manually by pressing **AUTO SYNC**.

NOTE

- The sync adjustment is automatically made each time the projector is turned on while connected to a computer or the input selection is changed.

- ① Press **AUTO SYNC** on the remote control.

On-screen Display

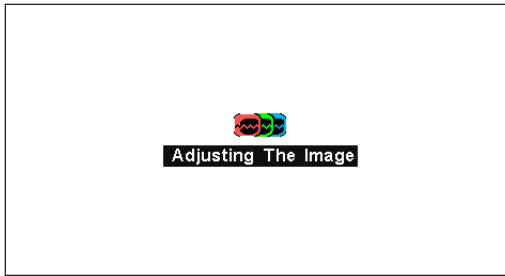

During Auto Sync adjustment, "Adjusting The Image" is displayed as shown on the left.

NOTE

- Auto Sync adjustment may take some time to complete, depending on the image of the computer connected to the projector.
- When the optimum image cannot be achieved with Auto Sync adjustment, use manual adjustments. (See page 27.)





Projector

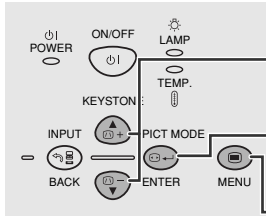

Remote control

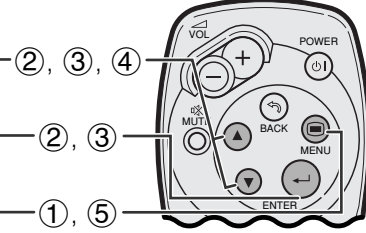

Adjusting the Computer Image

When displaying computer patterns which are very detailed (tiling, vertical stripes, etc.), interference may occur between the LCD pixels, causing flickering, vertical stripes, or contrast irregularities in portions of the screen. Should this occur, adjust “Clock”, “Phase”, “H-Pos” and “V-Pos” for the optimum computer image.

Description of Adjustment Items

Selected item	Description
Clock	Adjusts vertical noise.
Phase	Adjusts horizontal noise (similar to tracking on your VCR).
H-Pos	Centers the on-screen image by moving it to the left or right.
V-Pos	Centers the on-screen image by moving it up or down.

(GUI) On-screen Display



NOTE

- Computer image adjustments can be made easily by pressing **AUTO SYNC** (Ⓜ). See page 26 for details.

(Select the desired computer input mode with **INPUT** on the projector or **INPUT 2** on the remote control.)

- 1 Press **MENU**.
- 2 Press **▲/▼** to select “Fine Sync”, and then press **ENTER**.
- 3 Press **▲/▼** to select a specific adjustment item, and then press **ENTER**.
- 4 Press **▲/▼** to move the  mark of the selected adjustment item to the desired setting.
- 5 To exit from the GUI, press **MENU**.

NOTE

- The value range of “Clock” setting is limited by the type of signal received.
- To reset all adjustment items, select “Reset” on the “Fine Sync” menu screen and press **ENTER**.



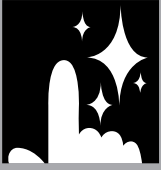

Useful Features



Freeze Function

Remote control

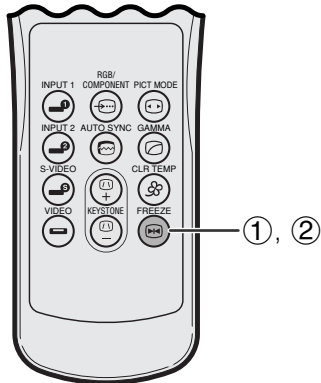

This function allows you to instantly freeze a moving image. This is useful when you want to display a still image from a computer or video, giving you more time to explain the image to the audience.

- ① Press **FREEZE** on the remote control to freeze the image.
- ② Press **FREEZE** again to return to the moving image.

On-screen Display

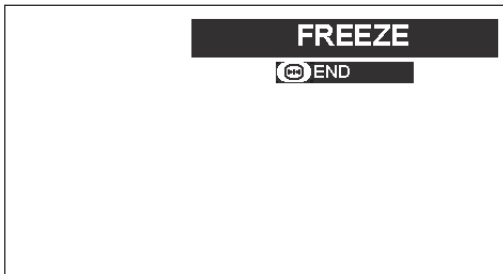



Adjusting the Color Temperature

Remote control

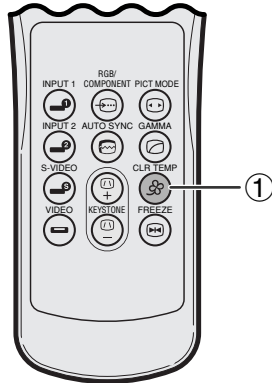

This function can be used to adjust the color temperature to suit the type of image input to the projector (video, computer image, TV broadcast, etc.). Decrease the color temperature to create warmer, reddish images for natural flesh tones. Increase the color temperature to create cooler, bluish images for a brighter picture.

Description of Color Temperature

1 (Red)	2	3	4 (Blue)
Decreases color temperature for warmer, reddish, incandescent-like images. (Low color temperature)			Increases color temperature for cooler, bluish, florescent-like images. (High color temperature)

On-screen Display

Position1

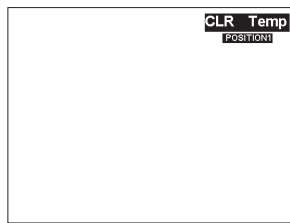

Position2

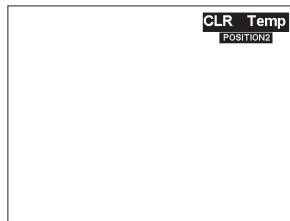

Position3

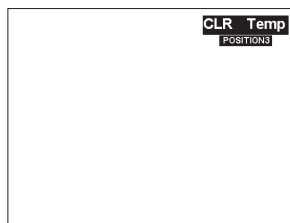

Position4

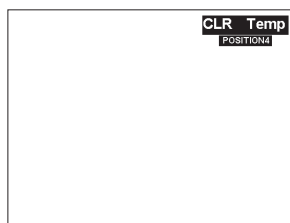

- ① Press **CLRTEMP** on the remote control. Each time **CLRTEMP** is pressed, color temperature toggles as shown below.

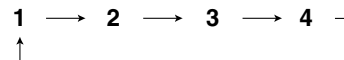



Gamma Correction

Remote control

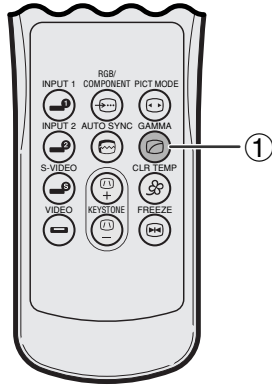

- Gamma is an image quality enhancement function that offers a richer image by brightening the darker portions of the image without altering the brightness of the brighter portions.
- Three gamma settings are available to allow for differences in the images displayed and in the brightness of the room.
- When you are displaying images with frequent, dark scenes, such as a film or concert, or when you are displaying images in a bright room, this feature makes the dark scenes easier to see and gives the impression of greater depth in the image.

Gamma Modes

Selected Mode	Gamma mode
STANDARD	For a highly defined image emphasizing high contrast and color reproduction.
GAMMA 1	For a warm and moist image controlling contrast and brightness.
GAMMA 2	Most suitable when viewing images in a brightly lit room.

On-screen Display

STANDARD

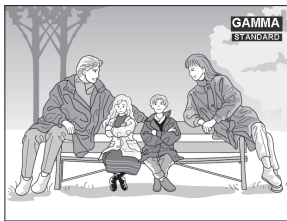

GAMMA 1

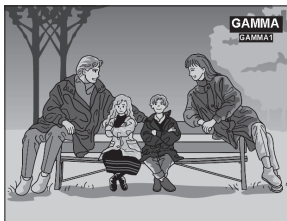

GAMMA 2

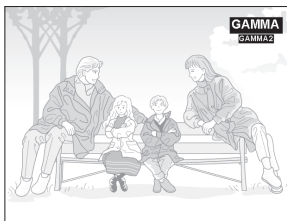

- ① Press **GAMMA** on the remote control. Each time **GAMMA** is pressed, the gamma level toggles as shown on the left.





Selecting the Picture Display Mode

Projector

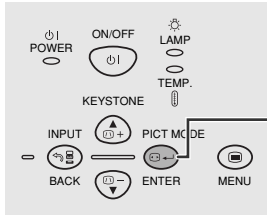

Remote control

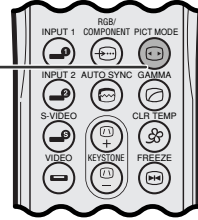

This function allows you to modify or customize the picture display mode to enhance the input image. Depending on the input signal, you can choose the picture display mode preferred.

- 1 Press **PICT MODE**. Each time **PICT MODE** is pressed, the picture mode changes as shown below.

EXAMPLE

			FULL	WIDE	NORMAL
Video	4:3 aspect ratio 480I/P, NTSC, PAL, SECAM	4:3	800 × 600	800 × 450	600 × 450
		Letterbox	800 × 600	800 × 450	600 × 450
		Squeeze	800 × 600	800 × 450	600 × 450
	16:9 aspect ratio, 720P, 1080i	720P, 1080i	-	800 × 450	-
Computer	VGA, SVGA, XGA, SXGA		800 × 600	-	-

	Input Signal	Output screen image		
		FULL	WIDE	NORMAL
480I/P, NTSC, PAL, SECAM	4:3 aspect ratio			
	Letterbox			
	Squeeze			
720P, 1080i	16:9 aspect ratio			

	Input Signal	Output screen image
		FULL
VGA, SVGA, XGA, SXGA	4:3 aspect ratio	

NOTE

- When inputting a VGA text mode (640 × 350) signal or an RGB signal from a device other than a computer, the display is fixed in FULL (4:3) mode, with the image filling up the whole screen.





Checking the Input Signal and the Lamp Usage Time

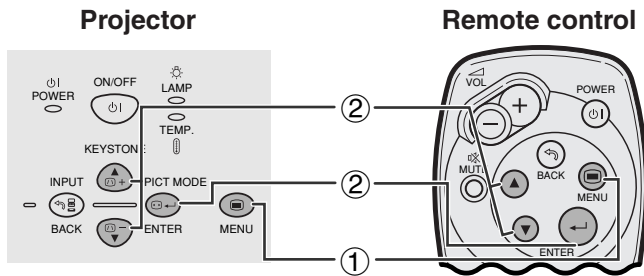

This function allows you to check the current input signal information and the accumulated lamp usage time.

- ① Press **MENU**.
- ② Press **▲/▼** to select "Options", and then press **ENTER**. The current input signal information and the lamp usage time will be displayed.

NOTE

- It is recommended that the lamp be replaced after approximately 900 hours of usage. See pages 38 and 39 for lamp replacement.

(GUI) On-screen Display



Automatic Power Shutoff Function

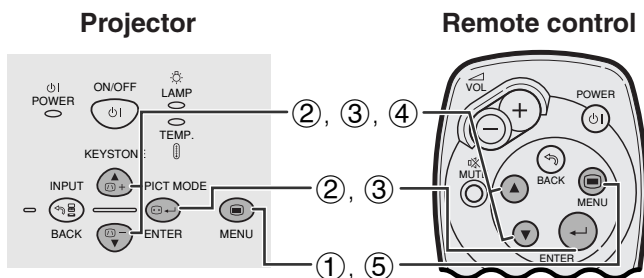

When no input signal is detected for more than 15 minutes, the projector will automatically shut off.

Description of Automatic Power Shutoff

ON	Power automatically shuts off after 15 minutes without a signal being input.
OFF	Automatic Power Shutoff disabled.

- ① Press **MENU**.
- ② Press **▲/▼** to select "Options", and then press **ENTER**.
- ③ Press **▲/▼** to select "Auto Power Off", and then press **ENTER**.
- ④ Press **▲/▼** to select "ON" or "OFF".
- ⑤ To exit from the GUI, press **MENU**.

NOTE

- "Auto Power Off" is factory preset to "ON".
- "Power OFF in 5 min." will appear five minutes before the power is automatically turned off.





Selecting a Background Image

Projector

Remote control

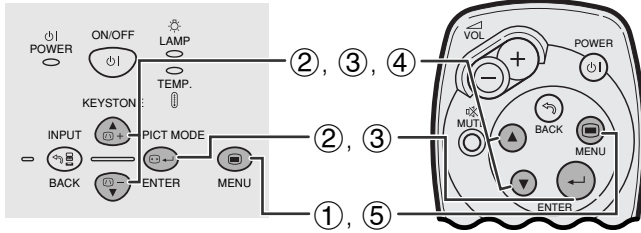

(GUI) On-screen Display



This function allows you to select the image displayed when no signal is being sent to the projector.

Description of Background Images

Blue	Blue screen	*1
None	Black screen	

- ① Press **MENU**.
- ② Press **▲/▼** to select “Options”, and then press **ENTER**.
- ③ Press **▲/▼** to select “Background”, and then press **ENTER**.
- ④ Press **▲/▼** to select “Blue” or “None”.
- ⑤ To exit from the GUI, press **MENU**.

NOTE

*1 While projecting the blue screen, the picture automatically switches to FULL (4:3) mode even if another display mode has been selected.



Theater Mode Function

Projector

Remote control

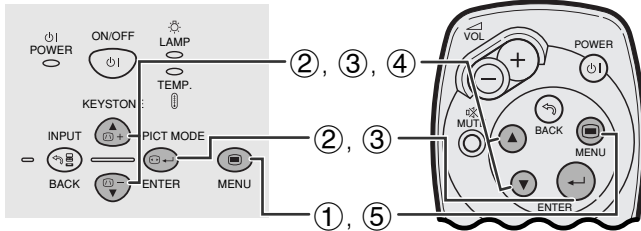

(GUI) On-screen Display

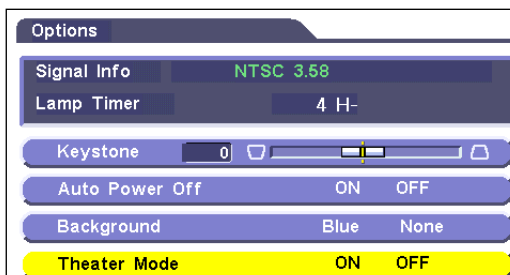

Function with toggle switch to control the quantity of projected light. Select “ON” or “OFF” to decrease or increase brightness, power consumption and fan noise.

Description of Theater Modes

ON	Quantity of light is 70%. Power consumption is 200 W.
OFF	Quantity of light is 100%. Power consumption is 230 W.

- ① Press **MENU**.
- ② Press **▲/▼** to select “Options”, and then press **ENTER**.
- ③ Press **▲/▼** to select “Theater Mode”, and then press **ENTER**.
- ④ Press **▲/▼** to select “ON” or “OFF”.
- ⑤ To exit from the GUI, press **MENU**.

NOTE

- “Theater Mode” is factory preset to “ON”.
- When selecting “OFF” in “Theater Mode”, fan noise is increased.
- Even when selecting “ON” in “Theater Mode”, fan noise may increase if internal temperature rises enough to activate the cooling function.





Reverse/Invert Image Function

Projector

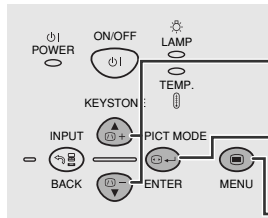

Remote control

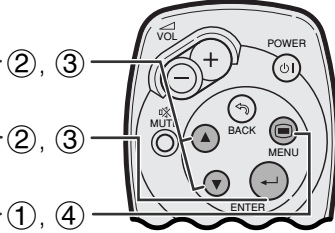

This projector is equipped with a reverse/invert image function which allows you to reverse or invert the projected image for various applications.

Description of Projected Images

Selected item	Projected image
Front	Normal image
Ceiling + Front	Inverted image
Rear	Reversed image
Ceiling + Rear	Reversed and inverted image

(GUI) On-screen Display



- ① Press **MENU**.
- ② Press ▲/▼ to select “PRJ Mode”, and then press **ENTER**.
- ③ Press ▲/▼ to select the desired projection mode, and then press **ENTER**.
- ④ To exit from the GUI, press **MENU**.

NOTE

- This function is used for the reversed image and ceiling-mount setups. See page 18 for these setups.



Special Mode Adjustment

Projector

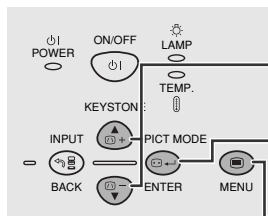

Remote control

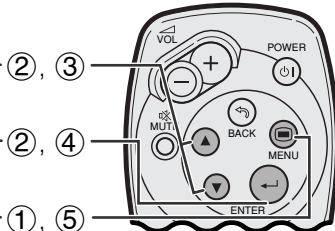

Ordinarily, the type of input signal is detected and the correct resolution mode is automatically selected. However, since the projector cannot distinguish 640×480 signal resolution on computers or 480P on DTVs, select an appropriate mode on “Special Modes.”

(GUI) On-screen Display

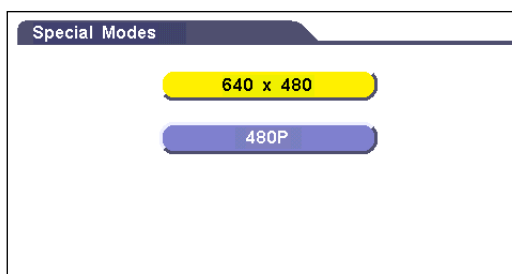

- ① Press **MENU**.
- ② Press ▲/▼ to select “Special Modes”, and then press **ENTER**.
- ③ Press ▲/▼ to select the optimal resolution mode.
- ④ Press **ENTER** to save the setting.
- ⑤ To exit from the GUI, press **MENU**.

NOTE

- When inputting DTV 480P signals, select “480P” in step ③ above.





Maintenance & Troubleshooting



Air Filter Maintenance

Right Side View

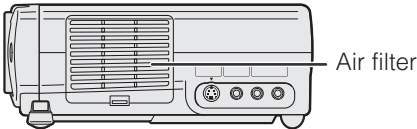

- This projector is equipped with an air filter to ensure the optimal operating condition of the projector.
- The air filter should be cleaned every 100 hours of use. Clean the filters more often when the projector is used in a dusty or smoky location.
- Have your nearest Authorized SharpVision Service Center or Dealer exchange the filter (PFILD0123CEZZ) when it is no longer possible to clean it.

Cleaning the air filter

1 Disconnect the power cord.

Unplug the power cord from the AC socket.

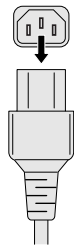

2 Remove the filter cover.

Turn over the projector. Press the tab and remove the filter cover in the direction of the arrow.

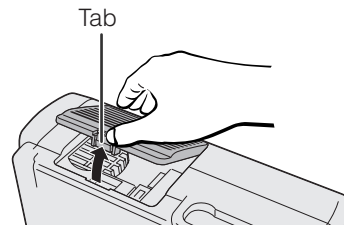

3 Clean the air filter.

Clean the dust off the air filter and cover with a vacuum cleaner extension hose.

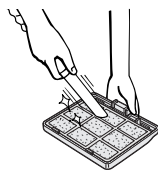

4 Replace the filter cover.

Insert the tab on the end of the filter cover into the filter cover opening and press the filter cover into position.

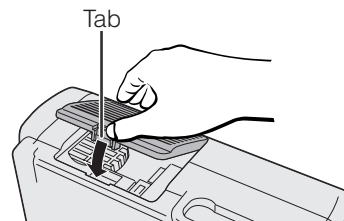

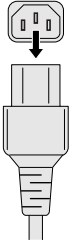
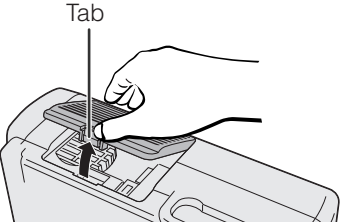
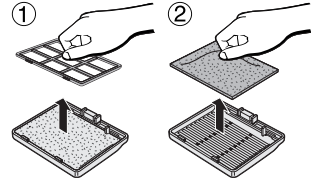
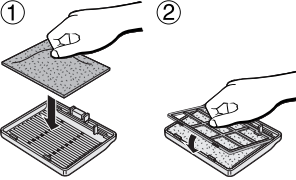
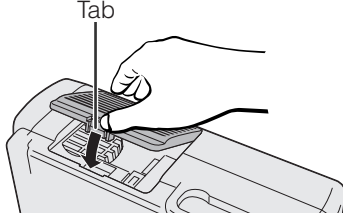

Replacing the air filter

<p>1 Disconnect the power cord.</p> <p>Unplug the power cord from the AC socket.</p> 	<p>2 Remove the filter cover.</p> <p>Turn over the projector. Press the tab and remove the filter cover in the direction of the arrow.</p> 	<p>3 Remove the air filter.</p> <p>① Remove the air filter stopper. ② Remove the air filter.</p> 
<p>4 Replace the air filter.</p> <p>① Put the new air filter into position. ② Put the air filter stopper back into position.</p> 	<p>5 Replace the filter cover.</p> <p>Insert the tab on the end of the filter cover into the filter cover opening and press the filter cover into position.</p> 	

NOTE

- Be sure the filter cover is securely installed. The power will not turn on unless it is correctly installed.





Lamp/Maintenance Indicators

Maintenance Indicators

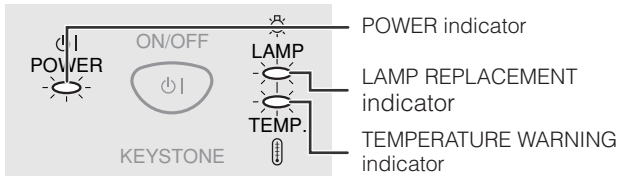

- The warning lights on the projector indicate problems inside the projector.
- There are two warning lights: a TEMPERATURE WARNING indicator which warns that the projector is too hot, and a LAMP REPLACEMENT indicator which lets you know when to change the lamp.
- If a problem occurs, either the TEMPERATURE WARNING indicator or the LAMP REPLACEMENT indicator will illuminate red. After turning off the power, follow the procedures given below.

Maintenance Indicator	Condition	Problem	Possible Solution
TEMPERATURE WARNING indicator	The internal temperature is abnormally high.	• Blocked air intake.	• Relocate the projector to an area with proper ventilation.
		• Clogged air filter.	• Clean the filter. (See pages 35 and 36.)
		• Cooling fan breakdown. • Internal circuit failure.	• Take the projector to your nearest Authorized SharpVision Service Center or Dealer for repair.
	The indicator flashes in red.	• Cooling down.	• Wait until the indicator stops flashing and turns off.
LAMP REPLACEMENT indicator	The lamp does not illuminate.	• Burnt-out lamp. • Lamp circuit failure.	• Carefully replace the lamp. (See pages 38 and 39.)
	The lamp requires replacement.	• Lamp has been used for over 900 hours.	• Take the projector to your nearest Authorized SharpVision Service Center or Dealer for repair.
POWER indicator	The indicator flashes in red when the projector is on.	• The filter cover is open.	• Securely install the filter cover.

NOTE

- If the TEMPERATURE WARNING indicator illuminates, follow the solution listed above and then wait until the projector has cooled down completely before turning the power back on. (At least 5 minutes.)
- If the power is turned off and then turned on again, as during a brief rest, the LAMP REPLACEMENT indicator may be triggered, preventing the power from going on. Should this occur, remove the power cord from the wall outlet and plug it in again.

Lamp

The lamp in this projector operates for approximately 1,000 cumulative hours, depending on the usage environment. It is recommended that the lamp be replaced after 900 cumulative hours of use or when you notice a significant deterioration of the picture and color quality. The lamp usage timer can be checked with the On-screen Display. (See page 32.)

CAUTION

- Intense light hazard. Do not attempt to look into the aperture and lens while the projector is operating.

NOTE

- As the usage environment can vary significantly, the projector lamp may not operate for 1,000 hours.
- "1,000 hours" above indicates average life span and should be used for reference only. This is different than the warranty period.
- For safety, the power will not be turned on from the fourth times when turning on the power without changing the lamp after use for 1,000 hours.

Condition	Problem	Possible Solution
The LAMP REPLACEMENT indicator illuminates red, and "LAMP" will appear in yellow in the lower-left corner of the picture.	• Lamp has been used for over 900 hours.	• Purchase a replacement lamp unit (lamp cage/module) of the current type BQC-PGC20X//1 from your nearest Authorized SharpVision Service Center or Dealer. • Replace the lamp. (See pages 38 and 39.) If you wish, you may have the lamp replaced at your nearest Authorized SharpVision Service Center or Dealer.
A significant deterioration of the picture and color quality occurs.		
The power will automatically turn off and the projector will enter standby mode.	• Lamp has been used for over 1,000 hours.	
"LAMP" will appear in red in the lower-left corner of the picture, and the power will turn off.		





Replacing the Projection Lamp

CAUTION:

- **Potential hazard of glass particles if lamp ruptures. Please have the nearest Authorized SharpVision Service Center or Dealer replace lamp if rupture occurs.**
- **Do not remove the lamp cage directly after operation of the projector. The lamp may be extremely hot. Wait at least one hour after the power cord is disconnected to allow the surface of the lamp cage to fully cool before removing the lamp cage.**

It is recommended that the lamp be replaced after approximately 900 cumulative hours of use or when you notice a significant deterioration of the picture and color quality. Carefully change the lamp by following the steps below. If the new lamp does not light after replacement, take your projector to the nearest Authorized SharpVision Service Center or Dealer for repair. Purchase a replacement lamp unit (lamp/cage module) of the current type BQC-PGC20X//1 from your nearest Authorized SharpVision Service Center or Dealer. Then carefully change the lamp by following the instructions below. If you wish, you may have the lamp replaced at your nearest Authorized SharpVision Service Center or Dealer.

IMPORTANT NOTE TO U.S. CUSTOMERS:

The lamp included with this projector is backed by a 90-day parts and labor limited warranty. All service of this projector under warranty, including lamp replacement, must be obtained through the nearest Authorized SharpVision Service Center or Dealer. For the name of the nearest Authorized SharpVision Service Center or Dealer, please call toll-free: 1-877-DTV-SHARP (1-877-388-7427).

U.S.A. ONLY

Removing and installing the lamp unit

CAUTION

- Be sure to remove the lamp cage by the handle. Be sure not to touch the glass surface of the lamp cage or the inside of the projector.
- To avoid injury to yourself and damage to the lamp, be sure to carefully follow the steps below.
- Be sure to change the air filter during lamp replacement. The air filter comes packaged with the lamp unit.

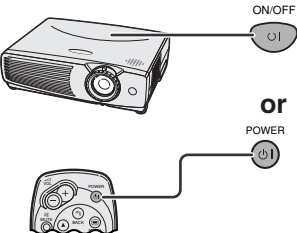
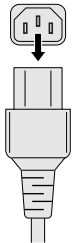
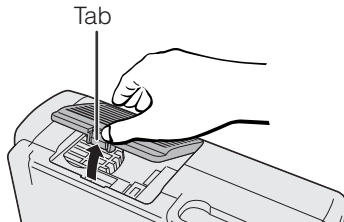
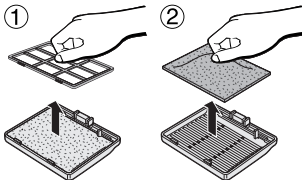
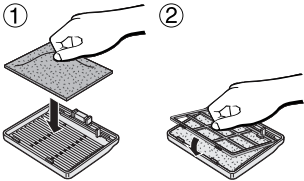
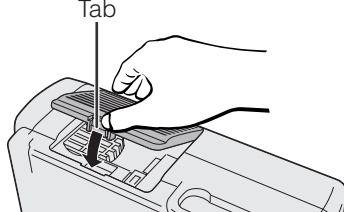
		First Change Filter (Steps 3-6)
<p>1 Turn off the power.</p> <p>Press ON/OFF on the projector or POWER on the remote control. Wait until the cooling fan stops.</p> 	<p>2 Disconnect the power cord.</p> <p>Unplug the power cord from the AC socket.</p> 	<p>3 Remove the filter cover.</p> <p>Turn over the projector. Press the tab and remove the filter cover in the direction of the arrow.</p> 
<p>4 Remove the air filter.</p> <p>① Remove the air filter stopper. ② Remove the air filter.</p> 	<p>5 Replace the air filter.</p> <p>① Put the new air filter into position. ② Put the air filter stopper back into position.</p> 	<p>6 Replace the filter cover.</p> <p>Insert the tab on the end of the filter cover into the filter cover opening and press the filter cover into position.</p> 





Replacing the Projection Lamp

Then Change Lamp (Steps 7-10)

7 Remove the lamp cage cover.

Turn over the projector and loosen the user service screw that secures the lamp cage cover. Then lift open the cover in the direction of the arrow.

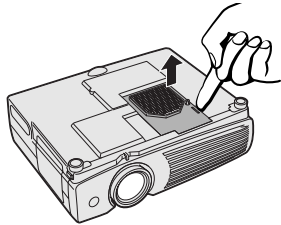

8 Remove the lamp cage.

Loosen the securing screws on the lamp cage. Hold the lamp cage by the handle and pull it towards you.

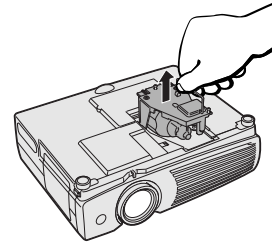

9 Insert the new lamp cage.

Press the lamp cage firmly into the lamp cage compartment. Fasten the securing screws.

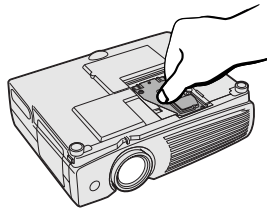

10 Attach the lamp cage cover.

Slide the lamp cage cover in the direction of the arrow. Then tighten the user service screw.

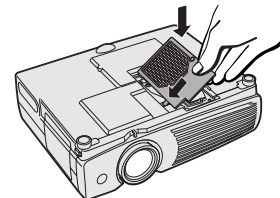

Resetting the lamp timer

1 Connect the power cord.

Plug the power cord into the AC socket of the projector.

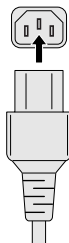

2 Reset the lamp timer.

- ① Press **KEYSTONE ▲** and **KEYSTONE ▼** on the projector at the same time.
- ② Press **INPUT** and **PICT MODE** on the projector at the same time.
- ③ Press **PICT MODE** and **MENU** on the projector at the same time.

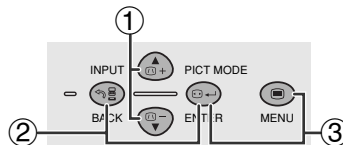

"LAMP 0000H" is displayed, indicating that the lamp timer is reset.

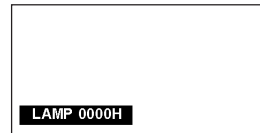

NOTE

- Reset the lamp timer only after replacing the lamp.





Using the Kensington Lock

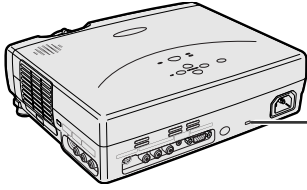

Kensington Security Standard connector

This projector has a Kensington Security Standard connector for use with a Kensington MicroSaver Security System. Refer to the information that came with the system for instructions on how to use it to secure the projector.



Troubleshooting

Problem	Check
No picture and no sound.	<ul style="list-style-type: none"> • Projector power cord is not plugged into the wall outlet. • The filter cover is not securely installed. • Selected input is wrong. (See page 16.) • Cables incorrectly connected to side and rear panels of the projector. (See pages 11–14.) • Remote control batteries have run down. (See page 8.)
Sound is heard but no picture appears.	<ul style="list-style-type: none"> • Cables incorrectly connected to side and rear panels of the projector. (See pages 11–14.) • “Contrast” and “Bright” adjustments are set to minimum position. (See page 24.)
Color is faded or poor.	<ul style="list-style-type: none"> • “Color” and “Tint” adjustments are not correct. (See page 24.)
Picture is blurred.	<ul style="list-style-type: none"> • Adjust the focus. (See page 15.) • Projection distance is too long or too short to allow for proper focus. (See page 17.)
Picture appears but no sound is heard.	<ul style="list-style-type: none"> • Cables incorrectly connected to side and rear panels of the projector. (See pages 11–14.) • Volume is set to minimum. (See page 16.)
An unusual sound is occasionally heard from the cabinet.	<ul style="list-style-type: none"> • If the picture is normal, the sound is due to cabinet shrinkage caused by temperature changes. This will not affect operation or performance.
Maintenance indicator illuminates.	<ul style="list-style-type: none"> • Refer to “Lamp/Maintenance Indicators” on page 37.
Picture noise appears.	<ul style="list-style-type: none"> • Adjust the “Phase” setting. (See page 27.)
480P images do not appear.	<ul style="list-style-type: none"> • Set the resolution mode to 480P. (See page 34.)
Color is distorted (INPUT 2 mode only).	<ul style="list-style-type: none"> • Change the input signal type. (See page 25.)





Appendix



Attaching the Lens Cap

Put on the lens cap to prevent damage to the lens when transporting the projector. A lens cap strap is provided to prevent the loss of the lens cap.

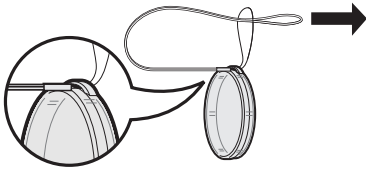
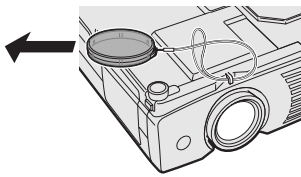
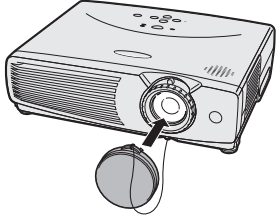
1 Attach the lens cap strap to the lens cap.	2 Attach the lens cap strap to the projector.	3 Attach the lens cap to the projector with the lens cap eyelet facing up.
		

CAUTION

- Do not lift or carry the projector by the lens or the lens cap as this may damage the lens.

NOTE

- You can also use the end of a mechanical pencil or other pointed object to feed the lens cap strap through the openings.





Connection Pin Assignments

INPUT 2 Port: 15-pin mini D-sub female connector

Computer Input

Analog

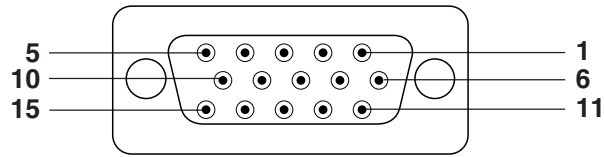

- | | |
|--------------------------------------|----------------------------|
| 1. Video input (red) | 9. Not connected |
| 2. Video input (green/sync on green) | 10. Not connected |
| 3. Video input (blue) | 11. GND |
| 4. Not connected | 12. Bi-directional data |
| 5. Composite sync | 13. Horizontal sync signal |
| 6. GND (red) | 14. Vertical sync signal |
| 7. GND (green/sync on green) | 15. Data clock |
| 8. GND (blue) | |

RS-232C Port: 9-pin D-sub male connector of the DIN-D-sub RS-232C cable

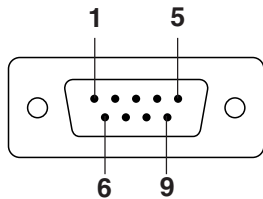

Pin No.	Signal	Name	I/O	Reference
1				Not connected
2	RD	Receive Data	Input	Connected to internal circuit
3	SD	Send Data	Output	Connected to internal circuit
4				Not connected
5	SG	Signal Ground		Connected to internal circuit
6				Not connected
7				Not connected
8				Not connected
9				Not connected

RS-232C Terminal: 9-pin Mini DIN female connector

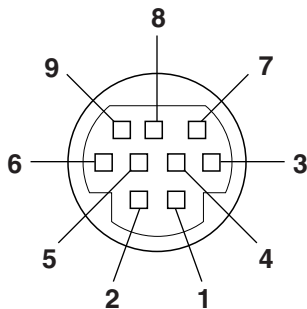

Pin No.	Signal	Name	I/O	Reference
1				Not connected
2	RD	Receive Data	Input	Connected to internal circuit
3	SD	Send Data	Output	Connected to internal circuit
4				Not connected
5	SG	Signal Ground		Connected to internal circuit
6				Not connected
7				Not connected
8				Not connected
9				Not connected





RS-232C Port Specifications

PC control

A computer can be used to control the projector by connecting an RS-232C cable (null modem, cross type, sold separately) to the projector. (See page 14 for connection.)

Communication conditions

Set the serial port settings of the computer to match that of the table.

Signal format: Conforms to RS-232C standard.

Baud rate: 9,600 bps

Data length: 8 bits

Parity bit: NON

Stop bit: 1 bit

Flow control: None

Basic format

Commands from the computer are sent in the following order: command, parameter, and return code. After the projector processes the command from the computer, it sends a response code to the computer.

Command format

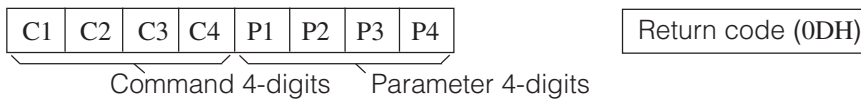

Response code format

Normal response



Problem response (Failure due to incorrect command/parameter or the other communication errors)



When more than one code is being sent, send each command only after the OK response code for the previous command from the projector is verified.

NOTE

- When using the computer control function of the projector, the projector operating status cannot be read to the computer. Therefore, confirm the status by transmitting the display commands for each adjustment menu and checking the status with the On-screen Display. If the projector receives a command other than a menu display command, it will execute the command without displaying the On-screen Display.





RS-232C Port Specifications

Commands

EXAMPLE

- When "BRIGHT" of RGB IMAGE ADJUSTMENT is set to -10.

Computer

Projector

R A B R _ _ 1 0 ↵



O K ↵

CONTROL ITEM	COMMAND				PARAMETER				CONTROL CONTENTS
	C1	C2	C3	C4	P1	P2	P3	P4	
AUTO POWER OFF	A	P	O	W	_	_	_	0	AUTO POWER OFF (OFF)
	A	P	O	W	_	_	_	1	AUTO POWER OFF (ON)
POWER SETTING	P	O	W	R	_	_	_	0	POWER OFF (STANDBY)
	P	O	W	R	_	_	_	1	POWER ON
INPUT SWITCHING	I	V	E	D	_	_	_	1	S-VIDEO
	I	V	E	D	_	_	_	2	VIDEO
	I	R	G	B	_	_	_	1	INPUT1
INPUT CHECK	I	R	G	B	_	_	_	2	INPUT2
	I	C	H	K	_	_	_	0	INPUT CHECK
KEYSTONE ADJUSTMENT	K	E	Y	S	*	*	*	*	KEYSTONE (-127 ~ +127)
LANGUAGE SELECTION	M	E	L	A	_	_	_	1	ENGLISH
	M	E	L	A	_	_	_	2	DEUTSCH
	M	E	L	A	_	_	_	3	ESPAÑOL
	M	E	L	A	_	_	_	4	NEDERLANDS
	M	E	L	A	_	_	_	5	FRANÇAIS
	M	E	L	A	_	_	_	6	ITALIANO
	M	E	L	A	_	_	_	7	SVENSKA
	M	E	L	A	_	_	_	8	PORTUGUÊS
	M	E	L	A	_	_	_	9	汉语
	M	E	L	A	_	_	_	10	한국어
VIDEO SYSTEM SELECTION	M	E	L	A	_	_	_	1	日本語
	M	E	S	Y	_	_	_	1	AUTO
	M	E	S	Y	_	_	_	2	PAL
	M	E	S	Y	_	_	_	3	NTSC 3.58
	M	E	S	Y	_	_	_	4	SECAM
	M	E	S	Y	_	_	_	5	NTSC 4.43
	M	E	S	Y	_	_	_	6	PAL (M)
	M	E	S	Y	_	_	_	7	PAL (N)
S-VIDEO/VIDEO IMAGE ADJUSTMENT 1	V	A	P	I	_	*	*	*	CONTRAST (-30 ~ +30)
	V	A	B	R	_	*	*	*	BRIGHT (-30 ~ +30)
	V	A	R	D	_	*	*	*	RED (-30 ~ +30)
	V	A	B	E	_	*	*	*	BLUE (-30 ~ +30)
	V	A	R	E	_	_	_	1	RESET
S-VIDEO/VIDEO IMAGE ADJUSTMENT 2	V	A	C	O	_	*	*	*	COLOR (-30 ~ +30)
	V	A	T	I	_	*	*	*	TINT (-30 ~ +30)
	V	A	S	H	_	_	_	*	SHARPNESS (0 ~ 7)
	V	A	R	E	_	_	_	2	RESET
S-VIDEO/VIDEO COLOR TEMPERATURE ADJUSTMENT	V	A	C	T	_	_	_	*	COLOR TEMPERATURE (1-4)
COMPONENT IMAGE ADJUSTMENT 1	R	A	P	I	_	*	*	*	CONTRAST (-30 ~ +30)
	R	A	B	R	_	*	*	*	BRIGHT (-30 ~ +30)
	R	A	R	D	_	*	*	*	RED (-30 ~ +30)
	R	A	B	E	_	*	*	*	BLUE (-30 ~ +30)
	R	A	R	E	_	_	_	1	RESET

CONTROL ITEM	COMMAND				PARAMETER				CONTROL CONTENTS
	C1	C2	C3	C4	P1	P2	P3	P4	
COMPONENT IMAGE ADJUSTMENT 2	R	A	C	O	_	*	*	*	COLOR (-30 ~ +30)
	R	A	T	I	_	*	*	*	TINT (-30 ~ +30)
	R	A	S	H	_	_	_	*	SHARPNESS (0 ~ 7)
	R	A	R	E	_	_	_	2	RESET
COMPONENT COLOR TEMPERATURE ADJUSTMENT	R	A	C	T	_	_	_	*	COLOR TEMPERATURE (1-4)
RGB IMAGE ADJUSTMENT	R	B	P	I	_	*	*	*	CONTRAST (-30 ~ +30)
	R	B	B	R	_	*	*	*	BRIGHT (-30 ~ +30)
	R	B	R	D	_	*	*	*	RED (-30 ~ +30)
	R	B	B	E	_	*	*	*	BLUE (-30 ~ +30)
	R	B	R	E	_	_	_	1	RESET
RGB COLOR TEMPERATURE ADJUSTMENT	R	B	C	T	_	_	_	*	COLOR TEMPERATURE (1-4)
BACKGROUND SELECTION	I	M	B	G	_	_	_	3	BLUE
	I	M	B	G	_	_	_	4	NONE
VOLUME ADJUSTMENT	V	O	L	A	_	_	_	*	VOLUME (00 ~ 60)
	M	U	T	E	_	_	_	1	MUTE ON
	M	U	T	E	_	_	_	0	MUTE OFF
SCREEN SETTING	I	M	R	E	_	_	_	0	REVERSE OFF
	I	M	R	E	_	_	_	1	REVERSE ON
	I	M	I	N	_	_	_	0	INVERT OFF
	I	M	I	N	_	_	_	1	INVERT ON
	I	M	I	P	_	_	_	0	2D PROGRESSIVE
	I	M	I	P	_	_	_	1	3D PROGRESSIVE
	I	M	I	P	_	_	_	2	FILM MODE1
INPUT2 SIGNAL TYPE SELECTION	I	M	I	P	_	_	_	3	FILM MODE2
	I	B	S	I	_	_	_	1	RGB
INPUT1 PICTURE MODE	I	B	S	I	_	_	_	2	COMPONENT
	R	A	S	R	_	_	_	1	FULL
INPUT2 PICTURE MODE	R	A	S	R	_	_	_	2	WIDE
	R	A	S	R	_	_	_	3	NORMAL
	R	B	S	R	_	_	_	1	FULL
S-VIDEO/VIDEO PICTURE MODE	R	B	S	R	_	_	_	2	WIDE
	R	B	S	R	_	_	_	3	NORMAL
	R	A	S	V	_	_	_	1	FULL
INPUT1/ S-VIDEO/VIDEO GAMMA SELECTION	R	A	S	V	_	_	_	2	WIDE
	R	A	S	V	_	_	_	3	NORMAL
	G	A	M	V	_	_	_	1	STANDARD
INPUT2 GAMMA SELECTION	G	A	M	V	_	_	_	2	GAMMA1
	G	A	M	V	_	_	_	3	GAMMA2
	G	A	M	R	_	_	_	1	STANDARD
INPUT AUTO SYNCHRONIZATION	G	A	M	R	_	_	_	2	GAMMA1
	G	A	M	R	_	_	_	3	GAMMA2
	A	D	J	S	_	_	_	1	AUTO SYNC START

NOTE

- If an underbar (_) appears in the parameter column, enter a space. If an asterisk (*) appears, enter a value in the range indicated in brackets under CONTROL CONTENTS.





Computer Compatibility Chart

Horizontal Frequency: 15–80 kHz

Vertical Frequency: 43–85 Hz

Pixel Clock: 12–108 MHz

Compatible with sync on green and composite sync signals

SXGA (1,280 × 1,024) compatible in intelligent compression

PC/MAC/WS	Resolution	Horizontal Frequency (kHz)	Vertical Frequency (Hz)	VESA Standard	Display
PC	640 × 350	27.0	60		Upscale
		31.5	70		
		37.9	85	×	
		27.0	60		
		31.5	70		
		27.0	60		
	720 × 350	31.5	70		
		27.0	60		
		31.5	70		
		37.9	85	×	
		27.0	60		
		31.5	70		
	640 × 400	31.5	70	×	
		37.9	85	×	
		27.0	60		
		31.5	70	×	
		37.9	85	×	
		26.2	50		
	720 × 400	31.5	60	×	
		34.7	70		
		37.9	72	×	
		37.5	75	×	
		43.3	85	×	
		31.3	50		
	640 × 480	35.1	56	×	
		37.9	60	×	
		44.5	70		
		48.1	72	×	
46.9		75	×		
53.7		85	×		
800 × 600	35.5	43	×		
	40.3	50			
	48.4	60	×		
	56.5	70	×		
	60.0	75	×		
	68.7	85	×		
VGA	640 × 480	31.3	50		Upscale
		35.1	56	×	
		37.9	60	×	
		44.5	70		
		48.1	72	×	
		46.9	75	×	
SVGA	800 × 600	53.7	85	×	True
		35.5	43	×	
		40.3	50		
		48.4	60	×	
		56.5	70	×	
		60.0	75	×	
XGA	1,024 × 768	68.7	85	×	Intelligent Compression
		35.5	43	×	
		40.3	50		
		48.4	60	×	
		56.5	70	×	
		60.0	75	×	

PC/MAC/WS	Resolution	Horizontal Frequency (kHz)	Vertical Frequency (Hz)	VESA Standard	Display
PC	SXGA	1,152 × 864	55.0	60	Intelligent Compression
			66.2	70	
			67.5	75	
		1,152 × 882	54.8	60	
			65.9	72	
			64.0	60	
PC/MAC 13"	VGA	640 × 480	35.0	67	Upscale
PC/MAC 19"	XGA	1,024 × 768	48.4	60	×
			60.0	75	×
MAC 16"	SVGA	832 × 624	49.7	75	Intelligent Compression
MAC 21"	SXGA	1,152 × 870	68.7	75	

NOTE

- This projector may not be able to display images from notebook computers in simultaneous (CRT/LCD) mode. Should this occur, turn off the LCD display on the notebook computer and output the display data in "CRT only" mode. Details on how to change display modes can be found in your notebook computer's operation manual.
- This projector can receive 640 × 350 VESA format VGA signals, however, "640 × 400" will appear on the screen.
- The image from Mac 16 (832 × 624) cannot be displayed in "FULL" mode.





Specifications

Product type	LCD Projector
Model	XV-Z7000U
Video system	PAL/PAL 60/PAL-M/PAL-N/SECAM/NTSC 3.58/NTSC 4.43/DTV 480P/DTV 720P/DTV 1080I
Display method	LCD panel × 3, RGB optical shutter method
LCD panel	Panel size: 0.9" (13.9 [H] × 18.5 [W] mm) Display method: Translucent TN liquid crystal panel Drive method: TFT (Thin Film Transistor) Active Matrix panel No. of dots: 480,000 dots (800 [H] × 600 [V])
Lens	1–1.2× zoom lens, F2.3–2.6, f = 36.0–43.2 mm
Projection lamp	DC 150 W lamp
Contrast ratio	350:1
Video input signal	RCA Connector: VIDEO, composite video, 1.0 Vp-p, sync negative, 75 Ω terminated RCA Connector: AUDIO, 0.5 Vrms more than 22 kΩ (stereo)
S-video input signal	4-pin Mini DIN connector Y (luminance signal): 1.0 Vp-p, sync negative, 75 Ω terminated C (chrominance signal): Burst 0.286 Vp-p, 75 Ω terminated
Component input signal	RCA Connector (INPUT 1 terminals) Y: 1.0 Vp-p, sync negative, 75 Ω terminated Pb: 0.7 Vp-p, 75 Ω terminated Pr: 0.7 Vp-p, 75 Ω terminated
Horizontal resolution	520 TV lines (DTV 720P input)
Audio output	1.0 W (monaural)
Computer RGB input signal	15-PIN MINI D-SUB CONNECTOR (INPUT 2 port): RGB separate/composite sync/sync on green type analog input: 0–0.7 Vp-p, positive, 75 Ω terminated STEREO MINI JACK: AUDIO, 0.5 Vrms, more than 22 kΩ (stereo) HORIZONTAL SYNC. SIGNAL: TTL level (positive/negative) or composite sync (Apple only) VERTICAL SYNC. SIGNAL: Same as above
Pixel clock	12–108 MHz
Vertical frequency	43–85 Hz
Horizontal frequency	15–80 kHz
Computer control signal	9-pin Mini DIN female connector (RS-232C port)
Speaker system	1 7/64" (2.8 cm) round
Rated voltage	AC 100–240 V
Input current	2.6 A
Rated frequency	50/60 Hz
Power consumption	230 W (Selecting "OFF" in the "Theater Mode".) 200 W (Selecting "ON" in the "Theater Mode".)
Operating temperature	41°F to 95°F (+5°C to +35°C)
Storage temperature	–4°F to 140°F (–20°C to +60°C)
Cabinet	Plastic
I/R carrier frequency	38 kHz
Dimensions (approx.)	10 15/64" (W) × 2 29/32" (H) × 8 5/32" (D) (260 × 74 × 207 mm) (main body only) 10 15/64" (W) × 3 15/64" (H) × 8 5/32" (D) (260 × 82 × 207 mm) (including adjustment feet and projecting parts)
Weight (approx.)	5.73 lbs. (2.6 kg)
Supplied accessories	Remote control, Two AAA size batteries, Rubber leg tips for remote control, Power cord (11' 10", 3.6 m), DIN-D-sub RS-232C cable (6 45/64", 15 cm), Extra air filter, Lens cap (attached), Lens cap strap, LCD projector operation manual
Replacement parts	Lamp unit (Lamp/cage module) (BQC-PGC20X//1), Remote control (RRMCG1636CESA), AAA size batteries, Rubber leg tips for remote control (GLEGG9095CEZZ), Power cord (CACCU5013DE01), DIN-D-sub RS-232C cable (QCNW-5288CEZZ), Air filter (PFILD0123CEZZ), Lens cap (PCOVZ1095CEKA), Lens cap strap (UBNDT0013CEZZ), LCD projector operation manual (TINS-7273CEZZ)

This SHARP projector uses LCD (Liquid Crystal Display) panels. These very sophisticated panels contain 480,000 pixels (× RGB) TFTs (Thin Film Transistors). As with any high technology electronic equipment such as large screen TVs, video systems and video cameras, there are certain acceptable tolerances that the equipment must conform to.

This unit has some inactive TFTs within acceptable tolerances which may result in illuminated or inactive dots on the picture screen. This will not affect the picture quality or the life expectancy of the unit. If you have any questions about this matter, please call toll free 1-877-DTV-SHARP (1-877-388-7427). U.S.A. ONLY

Specifications are subject to change without notice.





Dimensions

Rear View

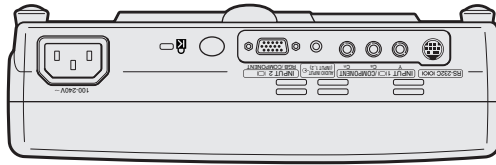

Top View

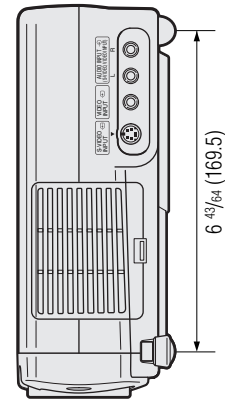
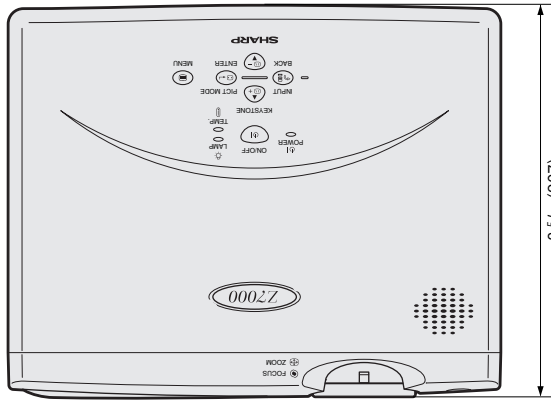
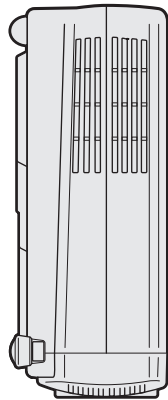

Side View

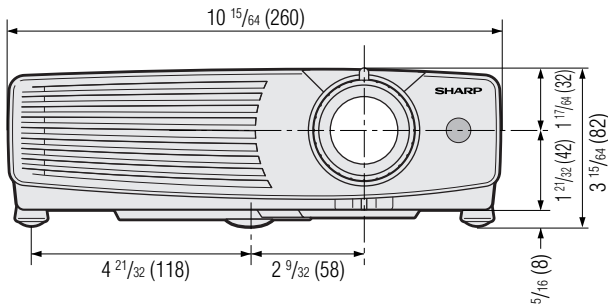

Front View

Bottom View

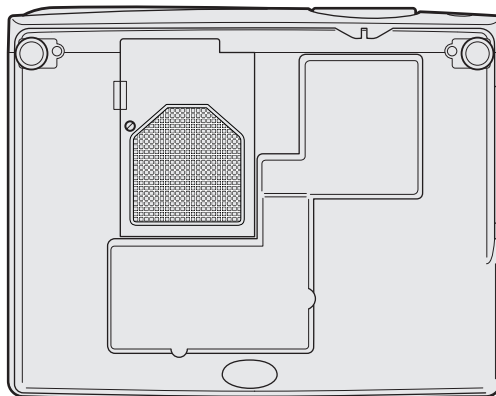



Glossary

Active digital keystone correction

Corrects keystone distortion caused when the projected image is not perpendicular to the screen. This method provides not only horizontal correction, but vertical as well, thus maintaining the original 4:3 aspect ratio and eliminating jag lines.

Aspect ratio

Width and height ratio of an image. The normal aspect ratio of a computer and video image is 4 : 3. There are also wide images with an aspect ratio of 16 : 9 and 21 : 9.

Auto sync

Optimizes projected computer images by automatically adjusting certain characteristics.

Background

Initial setting image projected when no signal is being input.

Clock

Clock adjustment is used to adjust vertical noise when clock level is incorrect.

Color temperature

Function that can be used to adjust the color temperature to suit the type of image input to the projector.

Freeze

Function to freeze a moving image.

Gamma correction

Offers richer image viewing with dark scene phase and contrast correction according to image and room brightness. Three gamma settings are available.

GUI

Graphical User Interface. User interface with graphics that allow easier operation.

Intelligent compression and expansion

High quality resizing of lower and higher resolution images to fit the projector's native resolution.

Phase

Phase shift is a timing shift between isomorphic signals with the same resolution. When phase level is incorrect, the projected image typically displays horizontal flicker.

Picture display mode

Allows you to modify or customize the picture display mode to enhance the input image.

Progressive mode (Film mode)

Optimizes the image by converting the interlaced signal to the progressive. Useful for displaying slow-moving images or still images.

RS-232C

Function to control the projector from the computer by using the RS-232C ports on the projector and computer.

Sync on green

Video signal mode of a computer which overlaps horizontal and vertical sync signal to green color signal pin.

Theater mode function

Function with toggle switch to control the quantity of projected light. Select "ON" or "OFF" to decrease or increase brightness, power consumption and fan noise.

