

SHARP®

AQUOS

LIQUID CRYSTAL TELEVISION
TÉLÉVISEUR À CRISTAUX
LIQUIDES
TELEVISOR DE CRISTAL
LÍQUIDO

OPERATION MANUAL
MODE D'EMPLOI
MANUAL DEL USUARIO

- Please choose your favorite page from the content.
If you want to close the operation manual, press the **EXIT** button.
Also, if you want to return to the previously displayed page, press the **RETURN** button.
- Veuillez choisir votre page favorite dans le contenu.
Appuyez sur le bouton **EXIT** pour refermer le mode d'emploi. Par ailleurs, appuyez sur le bouton **RETURN** si vous souhaitez revenir à la page précédemment affichée.
- Elija su página favorita entre los contenidos.
Si desea cerrar el manual de instrucciones, pulse el botón **EXIT**. Además, si desea volver a la página mostrada anteriormente, pulse el botón **RETURN**.





Contents



1. Part Names

- 1-1. TV
- 1-2. Remote Control Unit

2. Watching TV

- 2-1. Displaying an External Equipment Image
- 2-2. Initial Installation

3. Direct Button Operation

- 3-1. Changing Channels
- 3-2. Changing Volume
- 3-3. MUTE
- 3-4. FREEZE
- 3-5. FLASHBACK
- 3-6. SMART
- 3-7. NETFLIX
- 3-8. AUDIO
- 3-9. Sleep Timer
- 3-10. AV MODE
- 3-12. Closed Captions and Digital Closed Captions
- 3-14. VIEW MODE

4. On-Screen Display Menu

- 4-1. Introduction
- 4-3. On-Screen Display Menu Operation
- 4-4. Menu Operation Buttons
- 4-5. Initial Setup
- 4-14. Information
- 4-17. Picture Settings
- 4-21. Audio Settings
- 4-22. Smart TV
- 4-25. System Options

5. Enjoying Photo/Music/Video Playback

- 5-1. Preparation
- 5-2. Selecting the Folders to Play Back
- 5-4. Playing Back Files on a USB Memory Device/Home Network Server

6. Using LINK Operation

- 6-1. Controlling HDMI Equipment Using LINK Operation
- 6-3. Using a Smartphone with the TV

7. Using the Internet

- 7-1. Connecting to the Internet
- 7-2. Internet Setup
- 7-5. Entering Text (Software Keyboard)
- 7-7. Using the Browser
- 7-11. Using Keyboard and Mouse
- 7-12. Using Applications via the Internet
- 7-14. Notes

8. Using the Miracast devices

- 8-1. Miracast devices

9. Appendix

- 9-1. Removing the Stand
- 9-2. Setting the TV on the Wall
- 9-4. Troubleshooting
- 9-6. Troubleshooting - Error Message

10. Specifications

- 10-1. TV
- 10-5. Wireless LAN

11. Trademarks

12. Dimensional Drawings

- The dimensional drawings for the LCD TV set are shown on the inside back cover.

13. Software License



IMPORTANT INFORMATION







IMPORTANT:

To aid reporting in case of loss or theft, please record the TV's model and serial numbers in the space provided. The numbers are located at the rear and left side of the TV.

Model No.:

Serial No.:

WARNING: TO REDUCE THE RISK OF FIRE OR ELECTRIC SHOCK, DO NOT EXPOSE THIS PRODUCT TO RAIN OR MOISTURE.

 <div data-bbox="263 450 454 554" style="border: 1px solid black; padding: 5px; text-align: center;"> CAUTION RISK OF ELECTRIC SHOCK DO NOT OPEN </div> 	 <p>The lightning flash with arrow-head symbol, within an equilateral triangle, is intended to alert the user to the presence of uninsulated "dangerous voltage" within the product's enclosure that may be of sufficient magnitude to constitute a risk of electric shock to persons.</p>
<p>CAUTION: TO REDUCE THE RISK OF ELECTRIC SHOCK, DO NOT REMOVE COVER (OR BACK). NO USER-SERVICEABLE PARTS INSIDE. REFER SERVICING TO QUALIFIED SERVICE PERSONNEL.</p>	 <p>The exclamation point within a triangle is intended to alert the user to the presence of important operating and maintenance (servicing) instructions in the literature accompanying the product.</p>

CAUTION: TO PREVENT ELECTRIC SHOCK, MATCH WIDE BLADE OF PLUG TO WIDE SLOT, FULLY INSERT.

WARNING: FCC Regulations state that any unauthorized changes or modifications to this equipment not expressly approved by the manufacturer could void the user's authority to operate this equipment.

CAUTION: This product satisfies FCC regulations when shielded cables and connectors are used to connect the unit to other equipment. To prevent electromagnetic interference with electric appliances such as radios and televisions, use shielded cables and connectors for connections.

DECLARATION OF CONFORMITY:

SHARP LIQUID CRYSTAL TELEVISION, MODEL LC-65LE654U / LC-55LE653U / LC-48LE653U / LC-43LE653U

This device complies with Part 15 of the FCC Rules. Operation is subject to the following two conditions:

(1) This device may not cause harmful interference, and (2) this device must accept any interference received, including interference that may cause undesired operation.

RESPONSIBLE PARTY:

SHARP ELECTRONICS CORPORATION
Sharp Plaza, Suite 1, Mahwah, New Jersey 07495-1123
TEL: 1-800-BE-SHARP

For Business Customers: URL <http://www.sharpsusa.com>

INFORMATION:

This equipment has been tested and found to comply with the limits for a Class B digital device, pursuant to Part 15 of the FCC Rules. These limits are designed to provide reasonable protection against harmful interference in a residential installation. This equipment generates, uses and can radiate radio frequency energy and, if not installed and used in accordance with the instructions, may cause harmful interference to radio communications. However, there is no guarantee that interference will not occur in a particular installation. If this equipment does cause harmful interference to radio or television reception, which can be determined by turning the equipment off and on, the user is encouraged to try to correct the interference by one or more of the following measures:

- Reorient or relocate the receiving antenna.
- Increase the separation between the equipment and receiver.
- Connect the equipment into an outlet on a circuit different from that to which the receiver is connected.
- Consult the dealer or an experienced radio/TV technician for help.



IMPORTANT INFORMATION



FCC Compliance Statement

This device complies with part 15 of the FCC Rules. Operation is subject to the following two conditions:
(1) This device may not cause harmful interference, and (2) this device must accept any interference received, including interference that may cause undesired operation.

Wireless Radio

For product available in the USA/Canada market, only channel 1–11 can be operated. Selection of other channels is not possible. This device is going to be operated in 2.412–2.462GHz frequency range.

Important: Any changes or modifications not expressly approved by the party responsible for compliance could void the user's authority to operate the equipment.

FCC Radiation Exposure Statement: This equipment complies with FCC radiation exposure limits set forth for an uncontrolled environment. This equipment should be installed and operated with minimum distance 20cm between the radiator & your body.

Industry Canada Statement

This Class B digital apparatus complies with CAN ICES-003(B)/NMB-3(B)

Wireless Radio

For product available in the USA/Canada market, only channel 1–11 can be operated. Selection of other channels is not possible.

The device could automatically discontinue transmission in case of absence of information to transmit, or operational failure.

Note that this is not intended to prohibit transmission of control or signaling information or the use of repetitive codes where required by the technology.

Important: Any changes or modifications not expressly approved by the party responsible for compliance could void the user's authority to operate the equipment.

IC Radiation Exposure Statement: This device complies with IC RSS-210 rules; Operation is subject to the following two conditions:

(1) This device may not cause harmful interference, and (2) this device must accept interference received, including interference that may cause undesired operation.

Note to CATV system installer: This reminder is provided to call the CATV system installer's attention to Article 820 of the National Electrical Code that provides guidelines for proper grounding and, in particular, specifies that the cable ground shall be connected to the grounding system of the building, as close to the point of cable entry as practical.

This product qualifies for ENERGY STAR when "Home" is selected for "EZ Setup".

Setting "TV Location" to "Home" allows the TV to achieve an energy-saving status for household use.



DEAR SHARP CUSTOMER



Thank you for your purchase of the Sharp Liquid Crystal Television. To ensure safety and many years of trouble-free operation of your product, please read the Important Safety Instructions carefully before using this product.

IMPORTANT SAFETY INSTRUCTIONS

Electricity is used to perform many useful functions, but it can also cause personal injuries and property damage if improperly handled. This product has been engineered and manufactured with the highest priority on safety. However, improper use can result in electric shock and/or fire. In order to prevent potential danger, please observe the following instructions when installing, operating and cleaning the product. To ensure your safety and prolong the service life of your Liquid Crystal Television, please read the following precautions carefully before using the product.

- 1) Read these instructions.
- 2) Keep these instructions.
- 3) Heed all warnings.
- 4) Follow all instructions.
- 5) Do not use this apparatus near water.
- 6) Clean only with dry cloth.
- 7) Do not block any ventilation openings. Install in accordance with the manufacturer's instructions.
- 8) Do not install near any heat sources such as radiators, heat registers, stoves, or other apparatus (including amplifiers) that produce heat.
- 9) Do not defeat the safety purpose of the polarized or grounding-type plug. A polarized plug has two blades with one wider than the other. A grounding type plug has two blades and a third grounding prong. The wide blade or the third prong are provided for your safety. If the provided plug does not fit into your outlet, consult an electrician for replacement of the obsolete outlet.
- 10) Protect the power cord from being walked on or pinched particularly at plugs, convenience receptacles, and the point where they exit from the apparatus.
- 11) Only use attachments/accessories specified by the manufacturer.
- 12) Use only with the cart, stand, tripod, bracket, or table specified by the manufacturer, or sold with the apparatus. When a cart is used, use caution when moving the cart/apparatus combination to avoid injury from tip-over.
- 13) Unplug this apparatus during lightning storms or when unused for long periods of time.
- 14) Refer all servicing to qualified service personnel. Servicing is required when the apparatus has been damaged in any way, such as power-supply cord or plug is damaged, liquid has been spilled or objects have fallen into the apparatus, the apparatus has been exposed to rain or moisture, does not operate normally, or has been dropped.



Additional Safety Information

- 15) **Power Sources**—This product should be operated only from the type of power source indicated on the marking label. If you are not sure of the type of power supply to your home, consult your product dealer or local power company. For products intended to operate from battery power, or other sources, refer to the operating instructions.
- 16) **Overloading**—Do not overload wall outlets, extension cords, or integral convenience receptacles as this can result in a risk of fire or electric shock.
- 17) **Object and Liquid Entry**—Never push objects of any kind into this product through openings as they may touch dangerous voltage points or short-out parts that could result in a fire or electric shock. Never spill liquid of any kind on the product.
- 18) **Damage Requiring Service**—Unplug this product from the wall outlet and refer servicing to qualified service personnel under the following conditions:
 - a) When the AC cord or plug is damaged,
 - b) If liquid has been spilled, or objects have fallen into the product,
 - c) If the product has been exposed to rain or water,
 - d) If the product does not operate normally by following the operating instructions.
 Adjust only those controls that are covered by the operating instructions as an improper adjustment of other controls may result in damage and will often require extensive work by a qualified technician to restore the product to its normal operation,
 - e) If the product has been dropped or damaged in any way, and

IMPORTANT SAFETY INSTRUCTIONS

- f) When the product exhibits a distinct change in performance - this indicates a need for service.
- 19) **Replacement Parts**—When replacement parts are required, be sure the service technician has used replacement parts specified by the manufacturer or have the same characteristics as the original part. Unauthorized substitutions may result in fire, electric shock, or other hazards.
- 20) **Safety Check**—Upon completion of any service or repairs to this product, ask the service technician to perform safety checks to determine that the product is in proper operating condition.
- 21) **Wall or ceiling mounting**—When mounting the product on a wall or ceiling, be sure to install the product according to the method recommended by the manufacturer.

- **Outdoor Antenna Grounding** — If an outside antenna is connected to the television equipment, be sure the antenna system is grounded so as to provide some protection against voltage surges and built-up static charges. Article 810 of the National Electrical Code, ANSI/NFPA 70, provides information with regard to proper grounding of the mast and supporting structure, grounding of the lead-in wire to an antenna discharge unit, size of grounding conductors, location of antenna-discharge unit, connection to grounding electrodes, and requirements for the grounding electrode.

EXAMPLE OF ANTENNA GROUNDING AS PER NATIONAL ELECTRICAL CODE, ANSI/NFPA 70

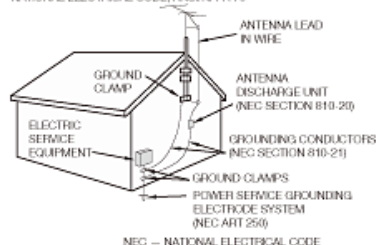

NEC — NATIONAL ELECTRICAL CODE

- **Water and Moisture** — Do not use this product near water - for example, near a bath tub, wash bowl, kitchen sink, or laundry tub; in a wet basement; or near a swimming pool; and the like.
- **Stand** — Do not place the product on an unstable cart, stand, tripod or table. Placing the product on an unstable base can cause the product to fall, resulting in serious personal injuries as well as damage to the product. Use only a cart, stand, tripod, bracket or table recommended by the manufacturer or sold with the product. When mounting the product on a wall, be sure to follow the manufacturer's instructions. Use only the mounting hardware recommended by the manufacturer.
- **Selecting the location** — Select a place with no direct sunlight and good ventilation.
- **Ventilation** — The vents and other openings in the cabinet are designed for ventilation. Do not cover or block these vents and openings since insufficient ventilation can cause overheating and/or shorten the life of the product. Do not place the product on a bed, sofa, rug or other similar surface, since they can block ventilation openings. This product is not designed for built-in installation; do not place the product in an enclosed place such as a bookcase or rack, unless proper ventilation is provided or the manufacturer's instructions are followed.
- The front panel used in this product is made of glass. Therefore, it can break when the product is dropped or applied with impact. Be careful not to be injured by broken glass pieces in case the panel breaks.
- **Heat** — The product should be situated away from heat sources such as radiators, heat registers, stoves, or other products (including amplifiers) that produce heat.
- The Liquid Crystal panel is a very high technology product with 2,073,600 pixels, giving you fine picture details. Occasionally, a few non-active pixels may appear on the screen as a fixed point of blue, green or red. Please note that this does not affect the performance of your product.
- **Lightning** — For added protection for this television equipment during a lightning storm, or when it is left unattended and unused for long periods of time, unplug it from the wall outlet and disconnect the antenna. This will prevent damage to the equipment due to lightning and power-line surges.
- **Power Lines** — An outside antenna system should not be located in the vicinity of overhead power lines or other electric light or power circuits, or where it can fall into such power lines or circuits. When installing an outside antenna system, extreme care should be taken to keep from touching such power lines or circuits as contact with them might be fatal.
- To prevent fire, never place any type of candle or flames on the top or near the TV set.
- To prevent fire or shock hazard, do not place the AC cord under the TV set or other heavy items.

IMPORTANT SAFETY INSTRUCTIONS

- Do not display a still picture for a long time, as this could cause an afterimage to remain.
- To prevent fire or shock hazard, do not expose this product to dripping or splashing. No objects filled with liquids, such as vases, should be placed on the product.
- Do not insert foreign objects into the product. Inserting objects in the air vents or other openings may result in fire or electric shock. Exercise special caution when using the product around children.

Precautions when transporting the TV

- When transporting the TV, never carry it by holding or otherwise putting pressure onto the display. Be sure to always carry the TV by two people holding it with two hands.



Caring for the cabinet

- Use a soft cloth (cotton, flannel, etc.) and gently wipe the surface of the cabinet.
 - Using a chemical cloth (wet/dry sheet type cloth, etc.) may deform the components of the main unit cabinet or cause cracking.
 - Wiping with a hard cloth or using strong force may scratch the surface of the cabinet.
 - If the cabinet is very dirty, wipe with a soft cloth (cotton, flannel, etc.) soaked in neutral detergent diluted with water and thoroughly wrung out, and then wipe with a soft dry cloth.
 - Avoid using benzene, thinner, and other solvents, as these may deform the cabinet and cause the paint to peel off.
 - Do not apply insecticides or other volatile liquids.
- Also, do not allow the cabinet to remain in contact with rubber or vinyl products for a long period of time. Plasticizers inside the plastic may cause the cabinet to deform and cause the paint to peel off.

Caring for the front panel

- Turn off the main power and unplug the AC cord from the wall outlet before handling.
- Gently wipe the surface of the front panel with a soft cloth (cotton, flannel, etc.). To protect the front panel, do not use a dirty cloth, liquid cleaners, or a chemical cloth (wet/dry sheet type cloth, etc.). This may damage the surface of the front panel.
- Wiping with a hard cloth or using strong force may scratch the surface of the front panel.
- Use a soft damp cloth to gently wipe the front panel when it is really dirty. (It may scratch the surface of the front panel when wiped strongly.)
- If the front panel is dusty, use an anti-static brush, which is commercially available, to clean it.
- To avoid scratching the frame or screen, please use a soft, lint free cloth for cleaning. Approved cleaning cloths are available directly from Sharp in single (00Z-LCD-CLOTH) or triple (00Z-LCD-CLOTH-3) packs. Call 1-800-BE-SHARP for ordering, or VISIT <http://www.sharppusa.com/SharpDirect>.



CHILD SAFETY: PROPER TELEVISION PLACEMENT MATTERS



THE CONSUMER ELECTRONICS INDUSTRY CARES

- Manufacturers, retailers and the rest of the consumer electronics industry are committed to making home entertainment safe and enjoyable.
- As you enjoy your television, please note that all televisions – new and old – must be supported on proper stands or installed according to the manufacturer's recommendations. Televisions that are inappropriately situated on dressers, bookcases, shelves, desks, speakers, chests, carts, etc., may fall over, resulting in injury.

TUNE IN TO SAFETY

- **ALWAYS** follow the manufacturer's recommendations for the safe installation of your television.
- **ALWAYS** read and follow all instructions for proper use of your television.
- **NEVER** allow children to climb on or play on the television or the furniture on which the television is placed.
- **NEVER** place the television on furniture that can easily be used as steps, such as a chest of drawers.
- **ALWAYS** install the television where it cannot be pushed, pulled over or knocked down.
- **ALWAYS** route cords and cables connected to the television so that they cannot be tripped over, pulled or grabbed.

WALL OR CEILING MOUNT YOUR TELEVISION

- **ALWAYS** contact your retailer about professional installation if you have any doubts about your ability to safely mount your television.
- **ALWAYS** use a mount that has been recommended by the television manufacturer and has a safety certification by an independent laboratory (such as UL, CSA, ETL).
- **ALWAYS** follow all instructions supplied by the television and mount manufacturers.
- **ALWAYS** make sure that the wall or ceiling where you are mounting the television is appropriate. Some mounts are not designed to be mounted to walls and ceilings with steel studs or cinder block construction. If you are unsure, contact a professional installer.
- Televisions can be heavy. A minimum of two people is required for a wall or ceiling mount installation.

MOVING AN OLDER TELEVISION TO A NEW PLACE IN YOUR HOME

- Many new television buyers move their older CRT televisions into a secondary room after the purchase of a flat-panel television. Special care should be made in the placement of older CRT televisions.
- **ALWAYS** place your older CRT television on furniture that is sturdy and appropriate for its size and weight.
- **NEVER** place your older CRT television on a dresser where children may be tempted to use the drawers to climb.
- **ALWAYS** make sure your older CRT television does not hang over the edge of your furniture.

CE.org/safety





IMPORTANT SAFETY INSTRUCTIONS



Wireless LAN

This TV has received the following certifications.

- Wi-Fi CERTIFIED™ (certification program from the Wi-Fi Alliance®)
- Wi-Fi Protected Setup™ (certification program from the Wi-Fi Alliance®)

FCC

This device complies with part 15 of the FCC Rules. Operation is subject to the following two conditions:

(1) This device may not cause harmful interference, and (2) this device must accept any interference received, including interference that may cause undesired operation. Changes or modifications not expressly approved by the party responsible for compliance could void the user's authority to operate the equipment. To comply with the FCC RF exposure compliance requirements, this device and its antenna must not be co-located or operated in conjunction with any other antenna or transmitter.

IC ID: 4451A-WN461XL

FCC ID: PPQ-WN461XL



Part Names



TV

(Front)

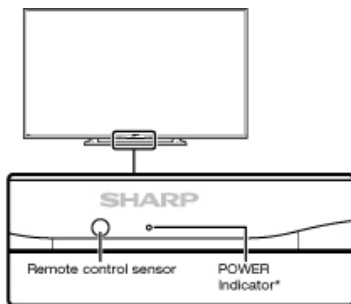

* See page 4-26.

(Side)

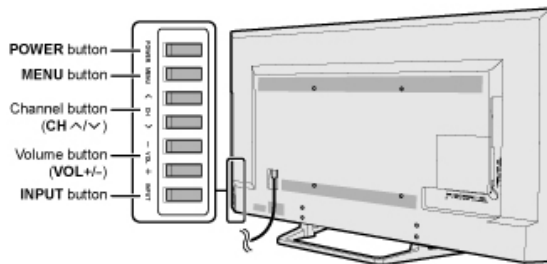

* See pages 2-1 and 4-4 for button operations.

(Rear)

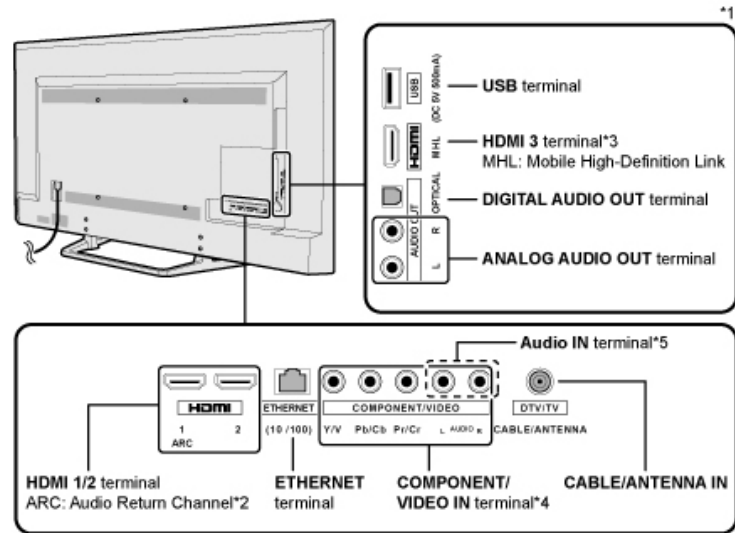

*1 See the Setup Guide.

[And see page 6-1](#) for external equipment connection.

*2 See page 6-2, for details on the Audio Return Channel.

*3 See page 6-3, for details on the MHL function.

*4 See page 4-12, for details on the Input Select function.

*5 See page 4-12 for details on the audio select of HDMI 1+ Analog.

• The illustrations and on-screen displays in this operation manual are for explanation purposes and may vary slightly from the actual operations.

**NOTE**

- When using the remote control unit, point it at the TV.

1 POWER: Switch the TV power on or enter standby.

2 0-9: Set the channel.

[\(See page 3-1.\)](#)

3 • (DOT): Set the channel.

[\(See page 3-1.\)](#)

4 DISPLAY: Display the channel information.

5 FREEZE: Set the still image. Press again to return to normal screen.

[\(See page 3-4.\)](#)

6 VOL +/-: Set the volume.

[\(See page 3-2.\)](#)

7 TV: Direct switch TV source.

8 SmartCentral: Display the application window.

[\(See page 3-6.\)](#)

9 USB: Direct switch USB source.

10 ▲▼/◀▶, ENTER: Select a desired item on the screen.

11 EXIT: Turn off the menu screen.

12 FAVORITE CH: Set the favorite channels.

[\(See page 4-7.\)](#)

13 A, B, C, D: Select 4 preset favorite channels in 4 different categories.

[\(See page 4-7.\)](#)

While watching, you can toggle the selected channels by pressing **A, B, C** and **D**.

14 SLEEP: Set the sleep timer.

[\(See page 3-9.\)](#)

15 CC: Display captions from a closed-caption source.

[\(See page 3-12 to 3-13.\)](#)

16 External equipment operational buttons: Operate the external equipment.

17 VIEW MODE: Select the screen size.

[\(See pages 3-14 to 3-16.\)](#)

18 AV MODE: Select an audio or video setting.

[\(See page 3-10.\)](#)

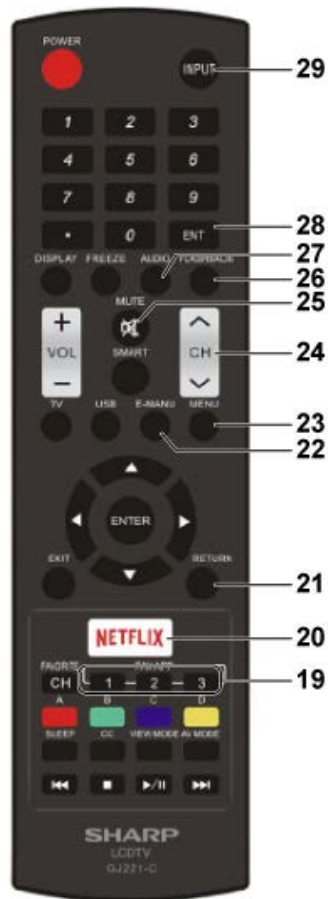
**NOTE**

- When using the remote control unit, point it at the TV.

19 FAV APP 1, 2, 3: You can assign your favorite applications to these buttons.
(See page 7-12.)

20 NETFLIX: Display the Netflix screen.
If you press the NETFLIX button when the TV is turned off, the TV turns on and the NETFLIX screen is displayed.
(See page 3-7.)

21 RETURN: Return to the previous menu screen.

22 E-MANU: Display the operation manual.

23 MENU: Display the menu screen.
(See page 4-1.)

24 CH/V: Select the channel.
(See page 3-1.)

25 MUTE: Mute the sound.
(See page 3-3.)

26 FLASHBACK: Return to the previous channel or external input mode.
(See page 3-5.)

27 AUDIO: Selects the MTS/SAP or the audio mode during multichannel audio broadcasts.
(See page 3-8.)

28 ENT: Jumps to a channel after selecting with the 0-9 buttons.

29 INPUT: Select a TV input source.
(See page 2-1.)



Watching TV



Displaying an External Equipment Image

To view external source images, select the input source by pressing **INPUT** on the remote control unit or on the TV.

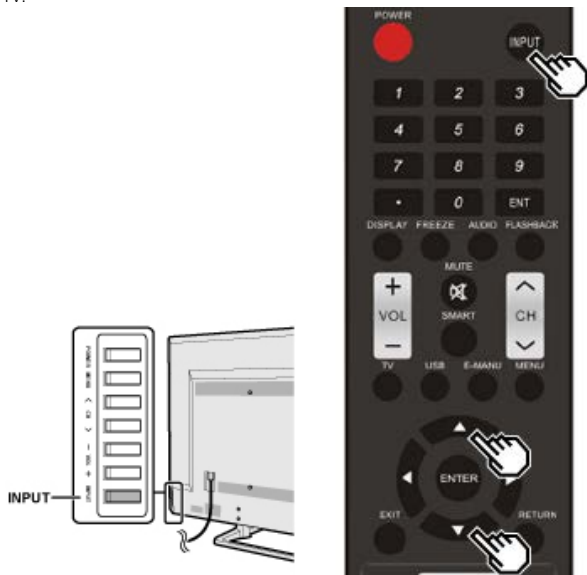

Example



- 1 Press **INPUT**.
 - The INPUT list screen displays.
- 2 Press **▲▼** to select the input source.
 - An image from the selected source automatically displays.

- You can also select the input source by pressing **INPUT**.
 - Each time **INPUT** is pressed, the input source toggles.
- TV → HDMI1 → Video → USB → Home Network → Miracast



Initial Installation

Perform the following steps before you press **POWER** on the remote control unit.

1. Insert the batteries into the remote control unit.
2. Connect the antenna cable to the TV.
3. Plug in the AC cord to the AC outlet.

Language (Language setting)

Select from among 3 languages: English, French and Spanish.

- 1 Press ▲▼ to select the desired language listed on the screen, and then press **ENTER**.



Location & Time

Make settings for the country, area and time zone where you use the TV.

- 2 Press ▲▼ to select "United States", "Canada" or "Mexico", and then press **ENTER**.



- 3 Press ▲▼ to select the time zone where you are using the TV, and then press **ENTER**.

Example

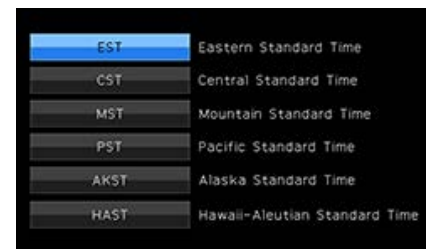

- The time zone differs depending on the selected country.
- The factory preset value is the time zone for the capital of the selected country.



Initial Installation (Continue)

4 Press ▲▼ to select the Daylight Savings Time, and then press **ENTER**.



- "Auto" is the default selection.

TV Location

Select "Home" or "Store" for the location where you plan to install the TV. This product qualifies for ENERGY STAR in Home mode default setting.

5 Press ◀▶ to select "Home" or "Store". Press **ENTER** to enter the setting.

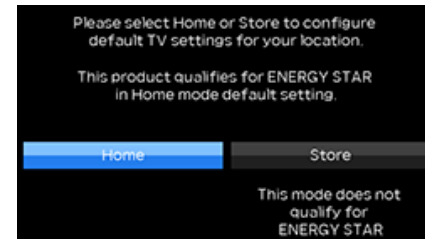

Home: AV MODE is set to "STANDARD (ENERGY STAR)".

Store: AV MODE is set to "DYNAMIC (Fixed)". Picture Reset and Feature Demo can be set.

Picture Reset: AV MODE will be set to "DYNAMIC (Fixed)" regardless of whether Picture Reset is "On" or "Off".

- If you select "On" and there is no operation for 30 minutes:
 - AV MODE will be reset to "DYNAMIC (Fixed)".
- When "Off" is selected:
 - Even after 30 minutes elapses, AV MODE is not reset to "DYNAMIC (Fixed)".

Feature Demo: When "On" is selected, after all the settings are completed, the Feature Demo screen is displayed if there is no operation for several minutes.

NOTE

- ENERGY STAR qualification is based on AV MODE "STANDARD (ENERGY STAR)".

Watching TV



Initial Installation (Continue)

Antenna & Cable/STB

Select the type of connection you will use to watch TV.

- 6 Press to select "Antenna & Cable" or "Set-top box", and then press **ENTER**.



To watch TV via an antenna or cable connection (without using a set-top box):

Select "Antenna & Cable", and then go to step 7.

To watch TV via a set-top box:

- 1 Select "Set-top box", and then press **ENTER**.
 2 Check that the set-top box connected to the TV is on.

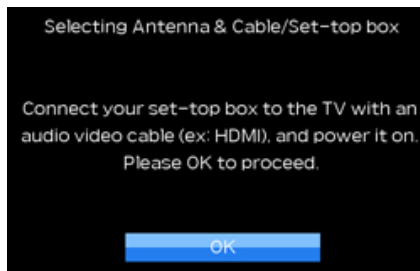

- 3 To watch TV, select the input source corresponding to the terminal connected to the set-top box. When doing so, you must make the setting to skip "TV". Press to select "On", and then press **ENTER**.



- When this is set to "On", the channel on the TV cannot be changed using the remote control unit or menu. (e.g. CH , Favorite CH, etc.)
- See [page 4-12](#) for details on the Input Skip function.
- 4 Press **INPUT** to select the input source corresponding to the terminal connected to the set-top box. Make the necessary settings on the connected external equipment.
- See the operation manual of the connected equipment for setting up the equipment.

Air/Cable (Antenna setting)

Make sure what kind of connection is made with your TV when selecting "Air" or "Cable".

- 7 Press to select "Air" or "Cable". Press **ENTER** to enter the setting.





Watching TV



Initial Installation (Continue)

CH Search (Channel search)

Channel auto search makes the TV look for all channels viewable in the set area.

8 When "Air" is selected in Antenna setting:

Press to select "Start", and then press **ENTER**.



When "Cable" is selected in Antenna setting:

Press to select "Analog & Digital Search Start" to search both analog and digital broadcasts, or to select "Analog Search Start" to search only analog broadcasts, and then press **ENTER**.

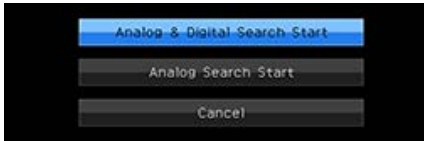

- The Channel search will start automatically.
- To exit the CHANNEL search screen, select "Cancel", and then press **ENTER**.

Smart TV

When you connect to the Internet on the TV, select the desired connection method and follow the instructions shown on the display.

- Wireless LAN connection is possible only when the WPS (push button) method is used. If any other method is used, make settings by Smart TV > Internet Setup. [\(See pages 7-2 to 7-4.\)](#)

9 Press to select "Yes", and then press **ENTER**.



10 Press to select "Wired" or "Wireless", and then press **ENTER**.





Initial Installation (Continue)

Connection using an ETHERNET cable:

- ① Select "Wired" and press **ENTER**.
- ② Confirm that the TV is properly connected with the router, and then press "Next". Follow the instructions on the display to perform the connection test.

Wireless LAN connection by the WPS method:

- ① Select "Wireless" and press **ENTER**.
- ② Follow the instructions on the display, and finalize the connection after testing its viability.

NOTE

- After you finish configuring the network settings, configure the "TV Name Setting".
([See pages 4-24, 7-3.](#))
- When you change the network settings, refer to Smart TV > Internet Setup.
([See pages 7-2 to 7-4.](#))

Completed

- 11 The settings confirmation screen is displayed. Confirm the information displayed on the screen, and then press **ENTER**.

Examples of the settings confirmation screen
When "Antenna & Cable" was selected in step 6.

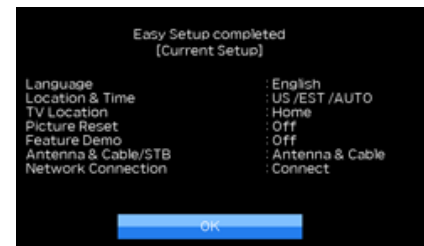



Initial Installation (Continue)

NOTE

- If no channel is found, confirm the type of connection made with your TV and try "Easy Setup" again. [\(See page 4-5.\)](#)

When "Set-top box" was selected in step 6.

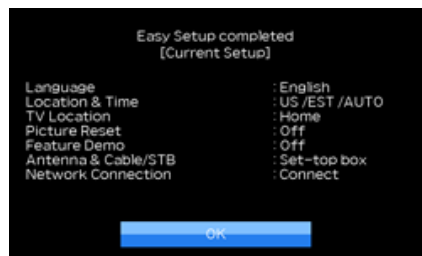

- Click "OK" to display the confirmation screen for input source switching.

Show the input list: You can check the current connection status of external equipment. Confirm which input terminal is connected to the set-top box.

OK: Clicking "OK" will complete the Easy Setup procedure.

- This may not display correctly depending on the connected equipment.
- This is not displayed correctly when the connected equipment is off.
- To watch TV using a set-top box, press **INPUT** after completing the initial settings, and select the input to which the set-top box is connected.

NOTE

- For changing the settings of the Initial Installation, perform "Easy Setup" on the Initial Setup menu on [page 4-5.](#)



Changing Channels

You can change channels in several ways.

Method 1

Using **CH**/**▲▼** on the remote control unit or on the TV.

Method 2

Using remote control buttons **0-9**, **• (DOT)**.

Examples:

To select a 1 or 2-digit channel number (e. g., Channel 5):

Press **5** → **ENTER**

To select a 3-digit channel number (e. g., Channel 115):

Press **1** → **1** → **5** → **ENTER**

To select a 4-digit channel number (e. g., Channel 22.1):

Press **2** → **2** → **• (DOT)** → **1** → **ENTER**

Method 3

Selecting the program from the Channel list.

1 Press **INPUT** on the remote control unit.

- The INPUT list displays.

2 Press **◀▶** to select "AIR" or "CABLE".

- The Channel list displays.

3 Press **▲▼** to select the desired channel, and then press **ENTER**.

NOTE

- When selecting a 1-digit channel number, it is not necessary to press **0** before the number.
- When you enter **0-9** only, channel selection will be made if there is no operation within a few seconds.
- If you push "0" by itself, nothing will happen.
- Complete the above steps within a few seconds.
- When you enter **0-9** and **• (DOT)**, channel selection will be made if there is no operation within a few seconds.



Changing Volume

You can change the volume by pressing **VOL+/-** on the TV or on the remote control unit.

- To increase the volume, press **VOL +**.
- To decrease the volume, press **VOL -**.



Audio status

Output device	Output Select	
	Fixed	Variable
Speaker	Variable sound	Mute

- When "Output Select" is set to "Variable", the indicator on the screen changes as shown below.



NOTE

- [See page 4-12](#) for details on the Output Select function.



MUTE

Mutes the current sound output.

Press **MUTE**.

-  will be displayed on the screen for 30 minutes, and the sound is silenced.

NOTE

- Within 30 minutes of pressing **MUTE**, mute can be canceled by pressing **VOL+/-** or **MUTE**.
- Mute will be canceled after 30 minutes have passed. However, the TV will not suddenly output a loud sound as the volume level is set to 0 automatically.



FREEZE

Allows you to capture and freeze a moving image that you are watching.

Press **FREEZE**.

- A moving image is captured.
- Press **FREEZE** again to cancel the function.

NOTE

- When this function is not available, "No displaying still image available." will display.
- The still image automatically goes out after 30 minutes.
- If you are using the freeze function and a broadcast activates the V-CHIP BLOCK, the freeze function will be canceled and a V-CHIP BLOCK message will appear.



FLASHBACK

Press **FLASHBACK** to switch to the previously tuned channel or previous input mode.

- Press **FLASHBACK** again to switch back to the currently tuned channel.

NOTE

- **FLASHBACK** will not work if no channel has been changed after the TV is turned on.



SMART

Allows you to directly activate various types of applications.

- 1 Press **SMART** to display the application window.
 - Press **SMART** again to switch back to the currently tuned channel.
- 2 Press **ENTER** to select the desired application, and then press **ENTER**.
 - If "X" is displayed, check the USB connection.
 - If "X" or "X" is displayed, check your TV's network settings and connection.

NOTE

- See page 5-2, 7-7 to 7-12 for details of viewable applications.
- When this function is not available, "Can not operate this function now" will display.



NETFLIX

Displays the Netflix screen.

Press **NETFLIX**.

NOTE

If you press the NETFLIX button when the TV is turned off, the TV turns on and the NETFLIX screen is displayed.

- To enjoy Netflix, you need to make:

—a broadband Internet connection

[\(See page 7-1.\)](#)

—settings of Internet Setup

[\(See pages 7-2 to 7-4.\)](#)

—adjustments for Netflix

[\(See page 7-13.\)](#)



AUDIO

MTS/SAP stereo mode

The TV has a feature that allows reception of sound other than the main audio for the program. This feature is called Multi-channel Television Sound (MTS). The TV with MTS can receive mono sound, stereo sound and Secondary Audio Programs (SAP). The SAP feature allows a TV station to broadcast other information, which could be audio in another language or something completely different like weather information.

You can enjoy Hi-Fi stereo sound or SAP broadcasts where available.

- **Stereo broadcasts:** View programs like live sporting events, shows and concerts in dynamic stereo sound.
- **SAP broadcasts:** Receive TV broadcasts in either MAIN or SAP sound.
 MAIN sound: The normal program soundtrack (either in mono or stereo).
 SAP sound: Listen to a second language, supplementary commentary or other information. (SAP is mono sound.)

If stereo sound is difficult to hear.

- Obtain a clearer sound by manually switching to fixed mono-sound mode.

You can change MTS as shown below to match the television broadcast signal.

Press **AUDIO** to toggle between audio modes.

Examples: when receiving MTS and SAP

STEREO mode: ST(SAP) → SAP(ST) → MONO

STEREO + SAP mode: STEREO ↔ MONO

MAIN + SAP mode: MAIN ↔ SAP

MONO mode: MONO

Digital broadcasting audio mode

The types of audio transmitted in a digital broadcast include SURROUND as well as MONO and STEREO. In addition, it is possible for multiple audio tracks to accompany a single video track.

Press **ENTER** to toggle between audio modes.

Example: when receiving Digital broadcasting

STEREO (Audio1) → STEREO (Audio2)
 ← SURROUND (Audio3) ←

NOTE

- MTS only operates while in TV mode.
- You can have the same settings by choosing "Change Audio" on the menu items.
[\(See page 4-25.\)](#)



AV MODE

AV MODE gives you several viewing options to choose from to best match the surrounding environment of the TV, which can vary due to factors like room brightness, type of program watched or the type of device connected.

You can use USER Mode to create customized settings for each TV input. These settings will be automatically saved on each input for convenience.

Press **AV MODE**. Current AV MODE displays.

- Press **AV MODE** again before the mode displayed on the screen disappears.
- The mode changes as shown below:

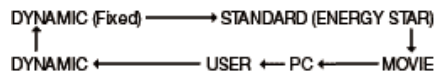



AV MODE (Continue)

STANDARD (ENERGY STAR): For a highly defined image in a normal lighting.

MOVIE: For a movie.

PC: For PC.

USER: Allows the user to customize settings as desired. You can set the mode for each input source.

DYNAMIC: For a clear-cut image emphasizing high contrast, useful for sports viewing.

DYNAMIC (Fixed): Changes the image and sound settings to the factory preset values. No adjustments are allowed.

NOTE

- You can select a different AV MODE item for each input mode. (For example, select STANDARD (ENERGY STAR) for TV input and DYNAMIC for COMPONENT.)
- You can have the same settings by choosing "AV MODE" on the menu items. [\(See page 4-17.\)](#)



Closed Captions and Digital Closed Captions

Your TV is equipped with an internal Closed Caption decoder. It allows you to view conversations, narration and sound effects as subtitles on your TV. Closed Captions are available on some TV programs and on some VHS home video tapes at the discretion of the program provider. Digital Closed Caption service is a new caption service available only on digital TV programs (also at the discretion of the service provider). It is a more flexible system than the original Closed Caption system, because it allows for a variety of caption sizes and font styles. When the Digital Closed Caption service is in use, it will be indicated by the appearance of a 3-letter abbreviation that also indicates the language of the Digital Closed Captions: ENG (English), SPA (Spanish), FRA (French) or other language codes. Not all programs and VHS videotapes offer closed captions. Please look for the  symbol to ensure that captions will be shown.

In the Closed Caption system, there can be more than one caption service provided. Each is identified by its own number. The "CC1" and "CC2" services display subtitles of TV programs superimposed over the program's picture. In the Closed Caption system, the "Text1" or "Text2" services display text that is unrelated to the program being viewed (e.g., weather or news). These services are also superimposed over the program currently being viewed.

1 Press **CC**.

- This will present the Closed Caption information display.

2 Press **CC** while the Closed Caption information is still on the screen.

- Press repeatedly until you select the desired closed caption service.



- Depending on the number of caption services in the signal being received, you will see information such as 1/2 or 1/4 displayed. 1/2 means "the first of two services".

Example:

If a program has three services (Digital CC(ENG), CC1 and Text1), the closed caption display will toggle in this sequence:



- The **CC** button keeps a record of the last service selected in its memory. If the last closed caption mode (e.g. 1/3 ENG) you selected is not available for the next program, or on another channel, the closed caption service that is available is automatically selected, and this service appears in parentheses, e.g. "1/3(CC1)". Closed Caption services that appear in parentheses will not be stored in the **CC** button's memory as your last selected service. Only services that you have selected with the **CC** button are stored.



Closed Captions and Digital Closed Captions (Continue)

Examples:

In a case where there are two closed caption services provided (for instance, Digital CC(ENG) and CC1), and Digital CC(ENG) is displayed as your current selection, if Digital CC(ENG) is not broadcast for the next program, the other closed caption service, CC1, will be displayed in parentheses.

A closed caption service appears in parentheses because the service you selected is not available and a different service is displayed on your screen. "1/1(CC1)" is displayed instead of "1/2/ENG".

NOTE

- See page 4-26 for detailed closed caption settings.
- When the program contains no closed caption, "--" displays in the closed caption information.
- If the language code, e.g. "ENG", is not found on Digital TV programs, "--" will be shown.
- Four kinds of closed caption service (CC1, CC2, Text1, Text2) are potentially available, but a broadcast may contain none or only some of these services at the discretion of the program provider.
- When a web page is displayed, Closed Captions are not available.
- You can have the same settings by choosing "Change CC" on the menu items.
(See page 4-25.)



VIEW MODE

You can select the screen size.

1 Press **VIEW MODE**.

- The View Mode menu displays.
- The menu lists the View Mode options selectable for the type of video signal currently being received.



2 Press **VIEW MODE** or ▲▼ while the View Mode menu is displayed to select a desired item on the menu.

- You can sequentially select a View Mode that has its own aspect ratio.

NOTE

- You can have the same settings by choosing "View Mode" on the menu items.
(See page 4-25.)
- Each time you press VIEW MODE when a browser screen is shown, the display pattern toggles between a website-only screen and a TV+Web screen.

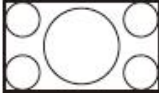
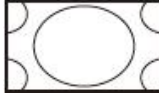
For HD programs

Stretch	Dot by Dot (Full Screen)	S.Stretch (Smart stretch)	Zoom
 <p>Suitable for viewing wide-screen 1.78:1 aspect ratio program, stretch mode will still show very thin black bands at the top and bottom of the screen.</p>	 <p>"Dot by Dot" when the number of pixels on the screen and the resolution of the signal are the same. "Full Screen" when the number of pixels on the screen and the resolution of the signal are different. In either case, the image fully fills the screen.</p>	 <p>Suitable for stretching 4:3 programs to fill the screen.</p>	 <p>Suitable for viewing wide-screen 2.35:1 aspect-ratio programs in full screen.</p>

NOTE

- When using Dot by Dot or Full Screen, it is possible to see noise or bars around different outer portions of the screen. Please change view mode to correct this.





Direct Button Operation



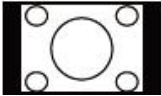

VIEW MODE (Continue)

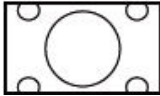
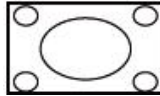
For 4:3 programs
 Example: Screen size images

Side Bar	S.Stretch (Smart stretch)	Zoom	Stretch
			
Suitable for viewing conventional 4:3 programs in their normal format.	Suitable for stretching 4:3 programs to fill the screen.	Suitable for viewing wide-screen 2.35:1 anamorphic DVDs in full screen.	This mode is useful for 1.78:1 DVDs. When viewing 1.85:1 DVDs, stretch mode will still show very thin black bands at the top and bottom of the screen.

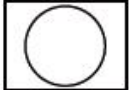
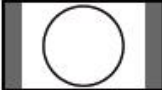
For USB-Video, Home Network Video or Internet applications
 Example: Screen size images

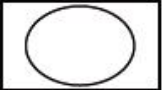
Input signal	Auto	Original	Stretch
			
	Keeps the original aspect ratio in a full screen display.	Displays an image by an original size.	An image fully fills the screen.







Direct Button Operation

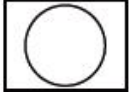
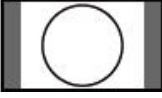

VIEW MODE (Continue)

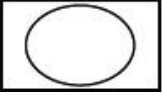
For PC
Example: Screen size images

Input signal	Normal	Zoom	Stretch	Dot by Dot
 4:3	 Keeps the original aspect ratio in a full screen display.	 For viewing widescreen programs. The top and bottom of the image is cropped.	 An image fully fills the screen.	 Detects the resolution of the signal and displays an image with the same number of pixels on the screen.

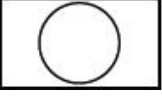
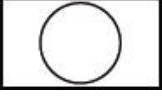
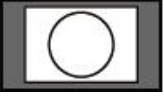
Input signal	Stretch	Dot by Dot
 16:9	 An image fully fills the screen.	 Detects the resolution of the signal and displays an image with the same number of pixels on the screen.

NOTE

- Connect the PC before making adjustments. See the Setup Guide.
- Selectable screen size may vary with input signal type.



On-Screen Display Menu



Introduction



① Guide display

- This indicates the buttons that can be operated on the displayed screen. The guide display varies depending on the menu setting screen.
- The operations for some selected items may be displayed in the operational guide bar at the bottom of the screen.

② Item displayed in blue

- This indicates the item currently selected.
- Press **ENTER** to go to the adjustment screen for this item.

③ Item in brackets

- This indicates the current setting for the item.

④ Item displayed in white

- This indicates that the item can be selected.

⑤ Item displayed in gray

- This indicates that the item cannot be selected.

There are various reasons why the items cannot be selected, but the main reasons are as follows:

- Nothing is connected to the selected input terminal.
- The function is not compatible with the current input signal.
- When this conflicts with other functions, you must change the settings for the other functions.



Introduction (Continue)

About Menu Items

- Some menu items may not be displayed depending on the selected input source.

NOTE

- The screens in the operation manual are for explanation purposes (some are enlarged, others cropped) and may vary slightly from the actual screens.
- The order of explanations for each menu item in the following pages is not necessarily in accordance with the alignment of the items on the screen.



LCFONT:

- This product is embedded with LC Font technology, which was developed by SHARP Corporation for clearly displaying easy-to-read characters on LCD screens.



On-Screen Display Menu Operation

Example

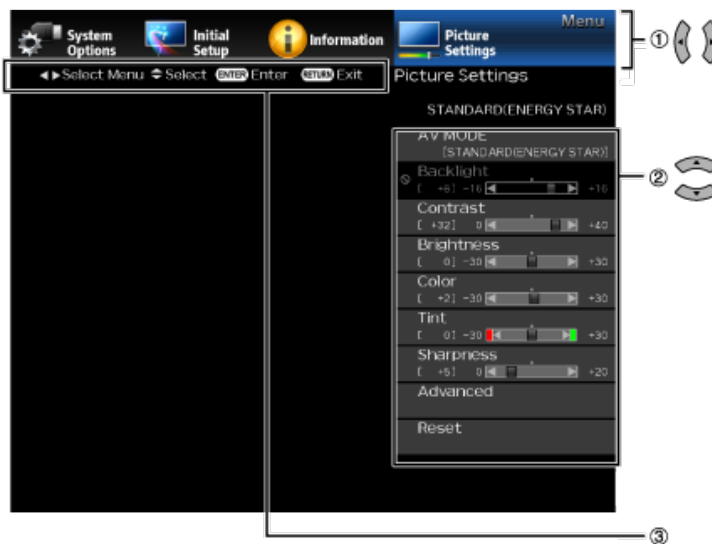

1 Press **MENU** to display the MENU screen.

2 ① Press **◀▶** to select the desired menu.

② Press **▲▼** to select a specific adjustment item, and then press **ENTER**.

- Additional related adjustment items may be displayed. Press **▲▼** to select the desired item.

③ Adjust the item while referring to the guide display.

- Operations vary depending on the function or item. Refer to the guide display corresponding to the menu setting screen for button operations.

3 Press **MENU** to exit.

NOTE

- Menu options differ in the selected input modes, but the operating procedures are the same.



Menu Operation Buttons

Using the remote control

Use the following buttons on the remote control to operate the menu.

MENU: Press to open or close the menu screen.

▲/▼/◀/▶: Press to select a desired item on the screen or adjust a selected item.

ENTER: Press to go to the next step or complete the setting.

RETURN: Press to return to the previous step.

Using the control panel of the TV

You can also operate the menu with the control panel of the TV.

Button operations on the control panel correspond to the ones on the remote control as shown below.

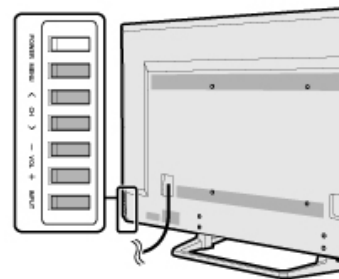

MENU: MENU on the remote control.

INPUT: ENTER on the remote control.

CH/▲/▼: Cursor ▲/▼ on the remote control.

VOL+/-: Cursor ◀/▶ on the remote control.

Example



Initial Setup

NOTE

- For operating the on-screen display menu, [see page 4-3](#).

Easy Setup

You can run Easy Setup again, even after setting up the preset channels.

Language: Select from among 3 languages (English, French and Spanish).

Location & Time: Make settings for the country, area and time zone where you use the TV.

Select your country: Select either "United States", "Canada" or "Mexico".

Select your time zone: Select your time zone. The available settings differ depending on the selected country.

Select DST (Daylight Savings Time): Select "AUTO", "Manual" or "Off".

TV Location: Select "Home" or "Store" for the location where you plan to install the TV. This product qualifies for ENERGY STAR in Home mode default setting.

Home: AV MODE is set to "STANDARD (ENERGY STAR)".

Store: AV MODE is set to "DYNAMIC (Fixed)". Picture Reset and Feature Demo can be set.

Picture Reset: AV MODE will be set to "DYNAMIC (Fixed)" regardless of whether Picture Reset is "On" or "Off". If you select "On", AV MODE will be reset to "DYNAMIC (Fixed)" if there is no operation for 30 minutes. When "Off" is selected, even after 30 minutes elapses, AV MODE is not reset to "DYNAMIC (Fixed)".

Feature Demo: When "On" is selected, after all the settings are completed, the Feature Demo screen is displayed if there is no operation for several minutes.

- ENERGY STAR qualification is based on AV MODE "STANDARD (ENERGY STAR)".

Antenna & Cable/STB: Select the type of connection you will use to watch TV.

Air/Cable: Make sure what kind of connection is made with your TV when selecting "Air" or "Cable".

CH Search: Channel auto search makes the TV look for all channels viewable in the set area.

- If "Cable" is selected for Antenna setting, scrambled channels are removed after the Channel search has been completed.

Smart TV: When you connect to the Internet on the TV, confirm the connection method and make adjustments.

- Wireless LAN connection is possible only when the WPS (push button) method is used. If any other method is used, make settings by Smart TV > Internet Setup.

[\(See pages 7-2 to 7-4.\)](#)

Completed: The settings confirmation screen is displayed. Confirm the information displayed on the screen.

NOTE

- See Initial Installation on [pages 2-2 to 2-7](#) for setting each item.
- If no channel is found, confirm the type of connection made with your TV and try "Easy Setup" again.
- If you select "Analog Search Start" and initiate the channel search, the CH Memory for Cable Digital will be deleted.

Example



Initial Setup (Continue)

Language

You can also select a language from the Initial Setup menu. Select from among 3 languages: English, French and Spanish.

NOTE

- To change the language of the manual, select "MENU" > "Initial Setup" > "Language" to change the language. Then, press **E-MANU** again.

TV Channel Setup

Channel Setup

If Initial Installation does not memorize all the channels in your region, follow the instructions below to manually memorize the channels.

Air/Cable: Make sure what kind of connection is made with your TV when selecting "Air" or "Cable".

CH Search: Channel auto search makes the TV look for all channels viewable in the set area.

CH Memory: You can select the channels to skip in each ANALOG (Air), ANALOG (Cable), DIGITAL (Air) and DIGITAL (Cable).

On: Skips channels. (Channel selection disabled using **CH** )

Off: Does not skip channels. (Channel selection enabled using **CH** )

NOTE

- See Initial Installation on [pages 2-2 to 2-7](#) for setting each item.
- If no channel is found, confirm the type of connection made with your TV and try channel search again.
- If you select "Analog Search Start" and initiate the channel search, the CH Memory for Cable Digital will be deleted.

Example



Initial Setup (Continue)

TV Channel Setup

Favorite CH (Favorite Channel Setting)

This function allows you to program 4 favorite channels, in 4 different categories. By setting the favorite channels in advance, you can select your favorite channels easily.

To register your favorite channel:

Select "Register" and then press **ENTER**. Press ▲/▼/◀/▶ to select the position in the category, and then press **ENTER** to register.

To delete your favorite channel:

Select "1 Data Clear" and then press **ENTER**. Press ▲/▼/◀/▶ to select the channel you want to delete, and then press **ENTER**. Select "Yes" and then press **ENTER**.

To delete all the favorite channels, select "All Data Clear".

NOTE

- Before setting the channel, select the channel you want to register as a favorite channel.
- You can display the "Favorite CH" screen by pressing **FAVORITE CH** on the remote control.

Antenna Setup-DIGITAL

In order to receive digital air broadcasts, you need a digital broadcast antenna. You can confirm the antenna configuration through the "Antenna Setup-DIGITAL" screen. If necessary, adjust the direction of the antenna to obtain the maximum signal strength.

Signal Strength: The signal strength of DIGITAL channel is displayed. The signal information is based on the current channel.

Channel Strength: Input the 2-digit channel number to check the signal strength of the selected channel. Make sure the signal is strong enough for each channel.

- This function is available for DIGITAL (Air) only.



On-Screen Display Menu

Example



Initial Setup (Continue)

Individual Setup

Secret No.

Allows you to use a secret number to protect certain settings from being accidentally changed.

IMPORTANT:

Three conditions must be met to enable the V-Chip

1. Secret No. is registered.
2. V-Chip/V-Chip (DTV Only) settings have been made.
 - The "V-Chip (DTV Only)" will only be selectable when a new rating system can be downloaded via digital broadcasting in the U.S.
3. "Status" is set to "Enable".

Setting Secret No.

You can set and change the secret number by using **0-9**.

New Secret No.: Changes or sets the Secret No.

Confirm Secret No.: Enter Secret No. to confirm.

NOTE

- As a precautionary measure, make a note of your secret number and keep it in a familiar place.

Parental Control (Parental Control Setting)

V-Chip

V-CHIP is an electronic filtering device built into your TV. This tool gives parents a great degree of control over broadcasts accessed by their children. It allows parents to select programs judged suitable for child viewing while blocking ones judged not suitable. It does so automatically once you activate the V-CHIP feature in your TV. "V-Chip" and "Status" will not be selectable from the menu if you do not first configure your secret number.

- The U.S. has two rating systems for viewing content: TV Parental Guidelines and movie ratings.
- The TV Parental Guidelines work in conjunction with the V-CHIP to help parents screen out inappropriate television shows from their children.
- Movie ratings are used for original movies rated by the Motion Picture Association of America (MPAA) as watched on cable TV and not edited for television. The V-CHIP can also be set to block MPAA-rated movies.

NOTE

- The setting automatically enters "Block" for any ratings below your selection.
- If Status is not set to "Enable", the configuration settings will not work.

MPAA (Voluntary movie rating system) Example

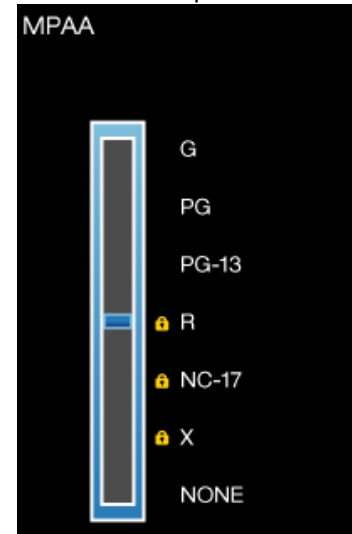

Press ▲/▼ to adjust the item to your desired position.

"■" indicates the item is blocked. Press **MENU** to exit.

G: General audiences. All ages admitted.

PG: Parental guidance suggested. Some material may not be suitable for children.

PG-13: Parents strongly cautioned. Some material may be inappropriate for children under 13.

R: Restricted. Under 17 requires accompanying parent or adult guardian (age varies in some jurisdictions).

NC-17: No one 17 and under admitted.

X: X is an older rating that is unified with NC-17 but may be encoded in the data of older movies.

NOTE

- Voluntary movie rating system only uses an age-based rating.



On-Screen Display Menu

Example



Initial Setup (Continue)

Individual Setup

Parental Control (Parental Control Setting)

TV Parental Guidelines

Example

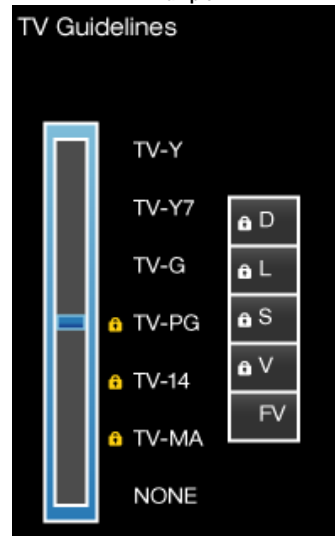

Suggested age

TV-Y: All children.

TV-Y7: Directed to older children.

TV-G: General audience.

TV-PG: Parental Guidance suggested.

TV-14: Parents strongly cautioned.

TV-MA: Mature audience only.

When setting an individual content-based rating item:

- 1 Press **▶** or **ENTER** to access blocked content items from the currently selected age-based rating item.
- 2 Press **▲/▼** to select an individual item, and then press **ENTER** to unblock it ("L" is removed). Repeat the same steps for the other items.
- 3 Press **◀** or **RETURN** to register after all individual content rating items are set.

Content

FV: Fantasy violence.

V: Violence.

S: Sexual situation.

L: Adult language.

D: Sexually suggestive dialog.

Rating	Content					
	FV	V	S	L	D	
Suggested age	TV-Y	⊗	⊗	⊗	⊗	⊗
	TV-Y7	×	⊗	⊗	⊗	⊗
	TV-G		⊗	⊗	⊗	⊗
	TV-PG		×	×	×	×
	TV-14		×	×	×	×
TV-MA		×	×	×		

⊗: The content rating can be set, but this rating is not normally broadcast by TV stations.

×: Content rating can be set.

Canadian Rating Systems (Canadian English ratings and Canadian French ratings)

- The TV rating systems in Canada are based on the Canadian Radio-Television and Telecommunications Commission (CRTC) policy on violence in television programming.
- While violence is the most important content element to be rated, the structure developed takes into consideration other program content like language, nudity, sexuality and mature themes.
- When setting the V-CHIP on the Canadian system you can choose either the Canadian English ratings or the Canadian French ratings.

Example



Initial Setup (Continue)

Individual Setup

Parental Control (Parental Control Setting)

Canadian English Ratings

- E:** Exempt: Includes news, sports, documentaries and other information programming; talk shows, music videos, and variety programming.
- C:** Children: Intended for younger children under the age of 8 years. Pays careful attention to themes that could threaten their sense of security and well-being.
- C8+:** Children over 8 years old: Contains no portrayal of violence as the preferred, acceptable, or only way to resolve conflict; nor encourage children to imitate dangerous acts which they may see on the screen.
- G:** General: Considered acceptable for all age groups. Appropriate viewing for the entire family, contains very little violence, physical, verbal or emotional.
- PG:** Parental Guidance: Intended for a general audience, but may not be suitable for younger children (under the age of 8) because it could contain controversial themes or issues.
- 14+:** Over 14 years: Could contain themes where violence is one of the dominant elements of the storyline, but it must be integral to the development of plot or character. Language usage could be profane and nudity present within the context of the theme.
- 18+:** Adults: Intended for viewers 18 years and older and might contain depictions of violence, which while related to the development of plot, character or themes, are intended for adult viewing. Could contain graphic language and portrayals of sex and nudity.

Canadian French Ratings

- E:** Exempt programming.
- G:** General: All ages and children, contains minimal direct violence, but may be integrated into the plot in a humorous or unrealistic manner.
- 8ans+:** General but inadvisable for young children: May be viewed by a wide public audience, but could contain scenes disturbing to children under 8 who cannot distinguish between imaginary and real situations. Recommended for viewing with parent.
- 13ans+:** Over 13 years: Could contain scenes of frequent violent scenes and therefore recommended for viewing with parent.
- 16ans+:** Over 16 years: Could contain frequent violent scenes and intense violence.
- 18ans+:** Over 18 years: Only for adult viewing. Could contain frequent violent scenes and extreme violence.

How to temporarily release the V-CHIP BLOCK

When the V-CHIP BLOCK is working and censors a broadcast, "V-CHIP HAS BEEN ACTIVATED." displays.

- 1 Press **ENTER** while the V-CHIP is working, and then the secret number setting menu displays.
- 2 Input the 4-digit secret number by using **0-9**. At this time V-CHIP BLOCK temporarily releases.

Example



Initial Setup (Continue)

Individual Setup

Parental Control (Parental Control Setting)

Reactivating the temporarily released V-CHIP BLOCK

You can reactivate the temporarily released V-CHIP BLOCK as shown below.

- Select "Status" setting from the Parental Control menu to reactivate BLOCK.
- Select "V-Chip" setting ("MPAA", "TV Guidelines", "Can. English Ratings" or "Can. French Ratings") from the Parental Control to reactivate BLOCK.
([See pages 4-8 to 4-10.](#))
- Switch off the TV power.

NOTE

- Performing any of the three above will activate the V-CHIP BLOCK.

Status

Used to enable or disable the parental control function. This function will not be selectable from the menu if you do not first configure your secret number.

Quick Start Mode

When this function is activated, you can reduce the TV's start-up time or even let the TV in standby mode start displaying images and so on via the connected equipment on the network.

NOTE

- Setting "Quick Start Mode" to "On" consumes more power.

Example



Initial Setup (Continue)

Input Settings

HDMI auto view

When you view images sent from external equipment in an HDMI connection, this function allows the image size on the TV to automatically switch to an appropriate one.

NOTE

- Refer to your external equipment operation manual for the signal type.

Digital audio output

You can output digital audio to an AV amplifier or similar device whose DIGITAL AUDIO INPUT terminal is connected to the DIGITAL AUDIO OUT terminal on the TV. Please select an audio output format compatible with the audio format of the program you are watching and the equipment connected.

PCM: For connecting to equipment that does not support Dolby Digital. The same audio (main, sub, or main/sub) as the audio of the program being viewed is output.

2-channel audio with a sampling rate of 48 kHz or less is output as linear PCM audio.

Bitstream: For connecting to an audio system that supports Dolby Digital. Audio is output through both the main and sub channels.

NOTE

- Analog channel audio and video input audio are output in PCM mode even when "Bitstream" is selected.
- PCM digital input signals are output in PCM mode even when "Bitstream" is selected.

Audio Select

This function sets the terminal to output the computer audio. The adjustment items vary depending on the input source. Select the input source corresponding to the terminal connected to the PC and then adjust the desired item.

HDMI 1(Digital): Select this when the TV and PC are connected using an HDMI-certified cable and audio is input via the same cable.

HDMI 1+ Analog: Select this when the TV and PC are connected using an HDMI-certified cable and the audio is input via an RCA audio to an RCA audio of component/video.

NOTE

- When "Audio Select" is set to "HDMI(Digital)", sound will not be produced if you use only an HDMI-certified cable to connect HDMI-compatible equipment. To produce sound, you should make an analog audio connection.
- If you want to connect HDMI-compatible equipment using only an HDMI-certified cable, set "Audio Select" to "HDMI(Digital)".

Output Select

Allows you to select what controls the audio output.

Fixed: Sound via speaker is adjusted with **VOL+/-** on the remote control unit or on the TV.

Sound via the AUDIO OUT terminal is not adjustable and outputs at a consistent level.

Variable: Sound via the AUDIO OUT terminal is adjusted with **VOL+/-** on the remote control unit or on the TV.

Sound via speaker is muted.

Input Select

For image input applied to the COMPONENT IN or VIDEO IN terminal, switch to "**COMPONENT**" or "**Video**", respectively.

COMPONENT: Select component video

Video: Select composite video.

NOTE

- If no (color) image display, try changing to another signal type.
- Check the operation manual of the external equipment for the signal type.

Input Skip

This setting allows you to skip the HDMI, COMPONENT or Video Input ("HDMI 1, HDMI 2, HDMI 3, COMPONENT and Video") on the Input Selection operation.

NOTE

- If you connect external equipment to an HDMI terminal which you have set to be skipped, a notification message appears on the display when a signal is received from the connected external equipment. Press "Yes" to reset the related skipping setting so that the

>>

On-Screen Display Menu

<<

Example



Initial Setup (Continue)

Input Settings

Color System

Select the video signal system compatible with your equipment from the list below:

AUTO/NTSC/PAL-M/PAL-N

NOTE

- "Color System" can only be set for the TV or Video.

LINK Setup

Make the settings to use LINK Operation.

Set the settings with "Initial Setup" > "Input Settings" > "LINK Setup".

[\(See page 6-2.\)](#)

Reset

If complex adjustments are made and the settings cannot be restored to normal, you can reset the settings to the factory preset values.

- If you have already set the Secret No., input the 4-digit secret number here.

NOTE

- The Channel Setup settings will not be changed.
- The Language settings will not be changed.
- The TV Location settings will not be changed.

Example

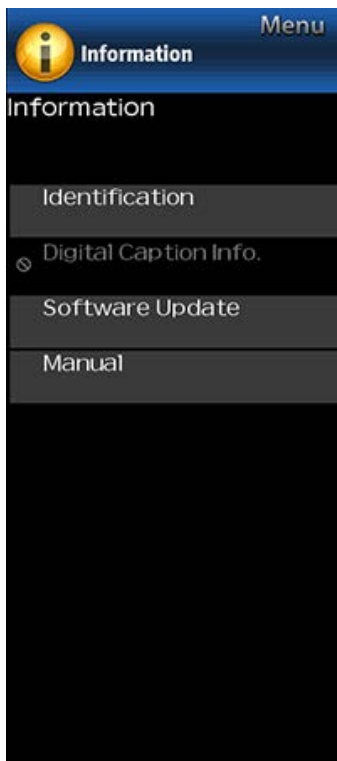

Information

NOTE

- For operating the on-screen display menu, [see page 4-3.](#)

Identification

The current version of the TV software is displayed.

Digital Caption Info.
(Digital Caption Information)

This function allows viewing of digital closed caption information for the digital broadcast program being viewed.

NOTE

- This list is not displayed for analog broadcasts or external input audio/video.
- This information is not included in CC1, CC2, Text1, or Text2, and is not displayed in a list.

Software Update

This is used to upgrade the system software to enhance the TV functions.

- 1 Press **MENU** to display the MENU screen, and then press **◀▶** to select "Information".
- 2 Press **▲▼** to select "Software Update", and then press **ENTER**.
- 3 Press **▲▼** to select "Manual Update" or "Auto Update Setting", and then press **ENTER**.
 - The operations thereafter vary depending on the setting.

Auto Update Setting

When the TV is on, or when an Internet application is being accessed, this function enables the TV to connect to the network and check for updates automatically.

When an update is available, a message is displayed.

Press **◀▶** to select "Yes", and then press **ENTER** to display the download screen.

[\(See page 4-16.\)](#)

NOTE

- This function does not work when a broadband connection or Internet Setup is not available.
- A message may also be displayed when an application is running. The message varies depending on the application.

Manual Update

Select the method for manually updating the software.

USB Update: Updates the software using a USB memory device containing the update file. (See "Updating the Software with a USB Memory Device".)

Network Update: Downloads the update file via the network and then updates the software.

[\(See page 4-16.\)](#)

NOTE

- A broadband connection and Internet Setup are required to update the software using the network. [\(See pages 7-2 to 7-4.\)](#)
- It may take time to access and download the update depending on the Internet connection and other factors.

Updating the Software with a USB Memory Device

To check for the availability of a software update, visit <http://www.sharpusa.com/products/support/>. If you have any questions, please

call 1-800-BE-SHARP (800-237-4277).

>>

On-Screen Display Menu

<<

Example

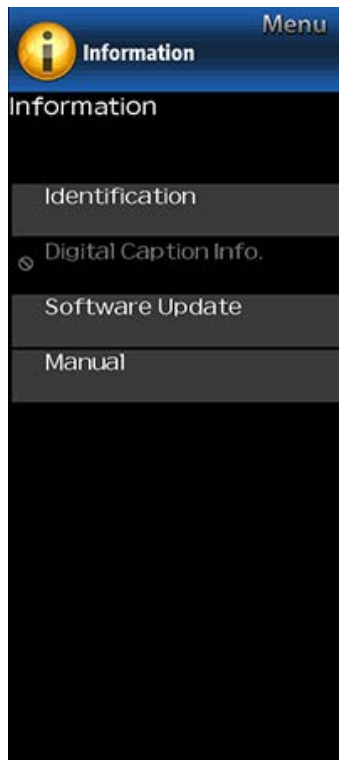

Information (Continue)

Software Update

Manual Update

CAUTION

- Do not remove the USB memory device or unplug the AC cord while the software is being updated.
- Be sure to properly follow the whole procedure described below, step by step. Otherwise, for example, the TV cannot read the data in the USB memory device and software updating will fail.

1 Insert the USB memory device with the update file into the USB terminal on the TV.

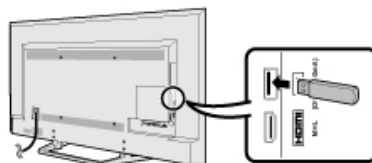

2 Press ▲/▼ on the Manual Update screen to select "USB Update", and then press **ENTER**.

3 Press **ENTER** to start checking the data in the USB memory device.



4 During the data checking, "Checking" blinks.

- The current version of the TV software and the version of the update file on the USB memory device are displayed.
- If the USB memory device is not properly installed or the correct update file cannot be found on the USB memory device, an error message is displayed. Check the file on the USB memory device, and then reinsert the USB memory device correctly.

Example

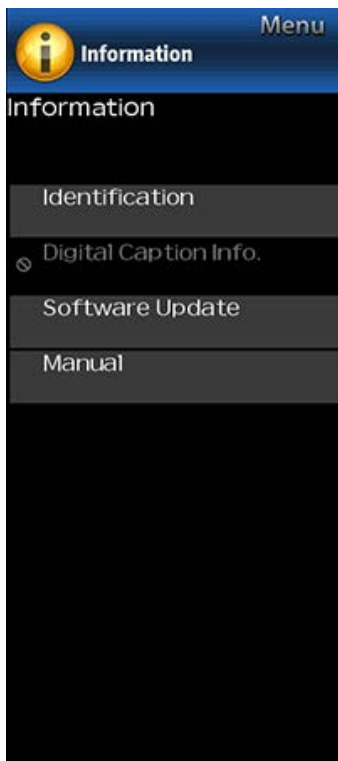

Information (Continue)

Software Update

Manual Update

CAUTION

- **Do not remove the USB memory device or unplug the AC cord while the software is being updated.**

5 When the software is successfully updated, a screen is displayed indicating that the update process is completed.

After this screen is displayed, the TV automatically turns off and then turns on again.

- If the update has failed, check the file in the USB memory device and try Software Update again.

6 Remove the USB memory device.

Updating the Software via the Network

1 Press ▲/▼ on the Manual Update screen to select "Network Update", and then press **ENTER**.

- The TV connects to the network and checks for updates.
- To cancel, press **ENTER**.

2 The current version of the TV and the latest version of software are displayed. To update the TV software, select "Yes", and then press **ENTER**.

- When a server connection cannot be established or an update is not available, a message is displayed. If a server connection cannot be established, check the broadband connection and Internet Setup.

3 After the update file is downloaded, the software update process begins.

CAUTION

- **Do not unplug the AC cord while the software is being updated.**

4 When the software is successfully updated, a screen is displayed indicating that the update process is completed.

- A screen indicating that the update is completed is displayed. 4 seconds later, the TV restarts automatically.
- If the software was not updated successfully, check the broadband connection and Internet Setup, and then try updating the software again.

Manual

Displays the built-in operation manual on the screen. You can read information about how to use this device.

Example



Picture Settings

Adjusts the picture to your preference with the following picture settings.

NOTE

- For operating the on-screen display menu, [see page 4-3](#).

Selected item	◀ button	▶ button
Backlight	The screen dims	The screen brightens
Contrast	For less contrast	For more contrast
Brightness	For less brightness	For more brightness
Color	For less color intensity	For more color intensity
Tint	Skin tones become reddish	Skin tones become greenish
Sharpness	For less sharpness	For more sharpness

- For resetting all Picture adjustment items to the factory preset values, press ▲/▼ to select "Reset", press **ENTER**, press ▲/▼ to select "Yes", and then press **ENTER**.

AV MODE (Changing Pic.Quality)

The audio and video settings can be changed to suit the program or input content being watched.

NOTE

- The selectable items vary depending on the input source and on the model of your TV.
- You can select AV MODE by pressing **AV MODE** on the remote control unit.
[See page 3-10](#) for details of AV MODE settings.

>>

On-Screen Display Menu

<<

Example

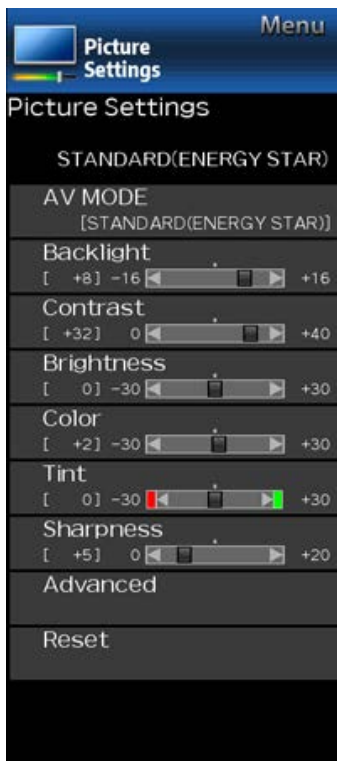

Picture Settings (Continue)

Advanced

Motion Enhancement (only for LC-65LE654U)

Use Motion Enhancement to view fast-action video more clearly.

Selected item	Description
AquoMotion240	Turn the LED backlight on or off for 120Hz drive display.
120Hz	For obtaining a clearer image.
Off	Original image.

NOTE

- "Motion Enhancement" may cause image noise. If this occurs, turn the function "Off".

Digital Noise Reduction

Produces a clearer video image.

AUTO: Automatically adjusts the level of noise reduction.

High/Middle/Low: You can select a desired level for viewing a clearer video image.

Off: No adjustment.

C.M.S. (Color Management System)

Color tone is managed using the six-color adjustment setting.

C.M.S.-Hue: This is a standard to adjust the color either more reddish or more bluish in tone.

C.M.S.-Saturation: Increases or decreases the saturation of a selected color.

C.M.S.-Value: A higher value makes the image brighter.

A lower value makes the image darker.

NOTE

- For resetting all adjustment items to the factory preset values, press ▲/▼ to select "Reset", and then press ENTER.

Example

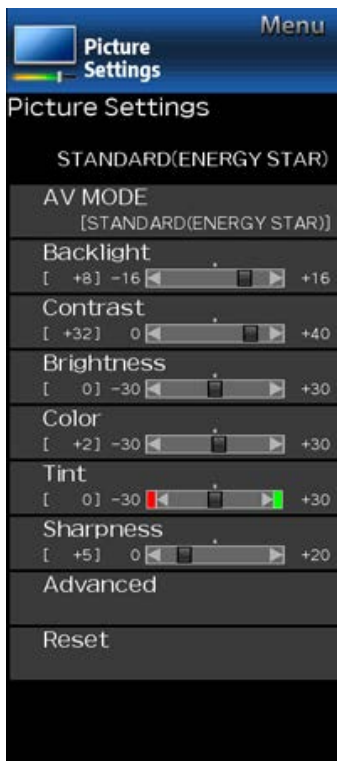

Picture Settings (Continue)

Advanced

Color Temp. (Color Temperature)

For a better white balance, use color temperature correction.

High: White with bluish tone



Middle:

Low: White with reddish tone

Fine tuning the color temperature

White balance can be adjusted between a maximum of +30 and a minimum of -30 for each color temperature.

NOTE

- For resetting all adjustment items to the factory preset values, press ▲/▼ to select "Reset", and then press ENTER.

Active Contrast

Automatically adjusts the image contrast according to the scene.

On: Produces high contrast image.

Off: No adjustment.

Film Mode (3:2 pull-down)

This function provides high-quality playback of images originally encoded at 24 frames/second, such as films.

Advanced: Adjusts effects to reduce judder film contents.

You can select a desired level of judder reduction from 0 to +3.

Standard: Plays back image with equal display time for each frame, reproducing movie theater experience.

Off: Normal viewing mode.

NOTE

- "Film Mode" does not function depending on input signal type.
- "Standard" does not function depending on input signal type.



On-Screen Display Menu

Example

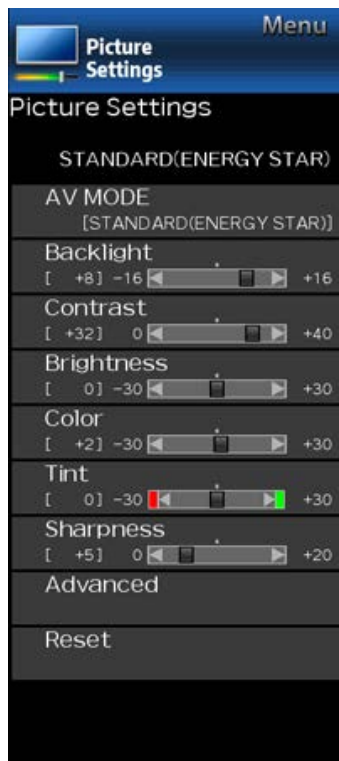

Picture Settings (Continue)

Advanced

Monochrome

For viewing a video in monochrome.

Reset

Returns Picture Settings to their factory preset values. To reset, select "Yes" and then press **ENTER**.



On-Screen Display Menu

Example



Audio Settings

You can adjust the sound quality to your preference with the following settings.

NOTE

- For operating the on-screen display menu, [see page 4-3.](#)

Selected item	◀ button	▶ button
Treble	For weaker treble	For stronger treble
Bass	For weaker bass	For stronger bass
Balance	Decrease audio from the right speaker	Decrease audio from the left speaker

NOTE

- The Audio menu is grayed out when "Output Select" is set to "Variable". [\(See page 4-12.\)](#)
- For resetting Audio adjustment items to the factory preset values, press ▲/▼ to select "Reset", press **ENTER**, press ▲/▼ to select "Yes", and then press **ENTER**.

SURROUND

The surround function produces Surround effect from the speakers.

NOTE

- The Audio Settings menu is grayed out when "Output Select" is set to "Variable". [\(See page 4-12.\)](#)
- For some discs, setup may be required on your BD/DVD player. In this case, please refer to the operation manual of your BD/DVD player.

Auto Volume

Different sound sources sometimes do not have the same loudness level, such as a program and its commercial breaks. The Automatic Volume Control(Auto Volume) reduces this problem by equalizing.

On: Reduces the loudness gaps among different sound source. The result is automatically adjusted according to the sound sources.

Off: No adjustment.

Reset

Returns Audio Settings to their factory preset values. To reset, select "Yes" and then press **ENTER**.

>>

On-Screen Display Menu

<<

Example



Smart TV

Dashboard

You can display a list of the main Smart TV settings.

Internet Setup

Configures LAN and Internet settings.

[\(See pages 7-2 to 7-4.\)](#)

AQUOS Remote Control

Set this function when operating the TV from equipment connected by LAN or wireless LAN.

AQUOS Remote Control

When "AQUOS Remote Control" is selected, "Change" will be highlighted. Press **ENTER**.

Detailed Settings

Make the detailed settings (Login ID, password, etc.). Follow the on-screen instructions to configure the settings.

Example



Smart TV (Continue)

Wallpaper

Activating the function will display still images when the TV is in standby mode.

Wallpaper Mode

Configures Wallpaper Mode settings.

Off: Nothing will be displayed.

On: Still images will be displayed when the TV is in standby mode.

Data Source

For the wallpaper, you can select either the still images pre-installed in the TV or your favorite still images stored in the USB memory device.

Pre-installed: The images pre-installed in the TV will be displayed in a slideshow.

USB: Your favorite images stored for the wallpaper will appear.

If only a single still image is stored in the USB memory device, that image will be displayed as the wallpaper.

When there are multiple still images in the memory, all the images will be displayed in a slideshow.

NOTE

- Images are displayed in 3-minute intervals as a slideshow.
- When the TV is in Wallpaper mode, you can turn off the TV by pressing and holding **POWER** on the TV for 5 seconds.
 - Just before the TV turns off, the last image shown when the TV was turned off appears briefly.
 - Your settings may not be saved in some cases.

When you display images by using the USB memory device:

- Create a folder named "WP" in the root directory of the USB memory device (the first directory when the USB memory device is opened), and store into the folder the still images you want to display for the wallpaper.
- You must insert the USB memory device to the TV before turning off the TV.
- If there are images on the USB memory device but they do not appear on the screen, switch to USB mode and check whether the image files on the USB memory device are shown correctly.

Timer Setting

You can set the length of time the TV will remain in the Wallpaper Mode.

3 hours/6 hours/12 hours/24 hours

NOTE

- No buttons except for **POWER** work even while the still images are being displayed.
- If the ready-for-use USB memory device is not inserted, the still images pre-installed in the TV will be displayed in a slideshow even when "Data Source" is set to "USB".
- Because the USB memory device cannot be detected immediately after the TV is turned on from standby mode, the wallpaper pre-installed in the TV may be displayed even when "Data Source" is set to "USB".
- The still images will be displayed until the set time has elapsed.

Example



Smart TV (Continue)

Miracast

You can connect a device such as a Miracast-compatible smartphone or tablet to the TV.

[\(See page 8-1.\)](#)

Advanced

TV Name Setting

Set this function when operating the TV from equipment connected by LAN or wireless LAN. Use the software keyboard when you need to input text at TV Name Setting.

Software Keyboard

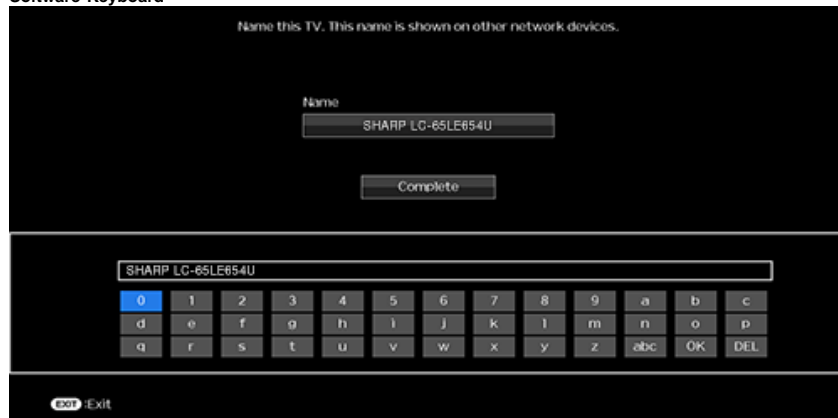
**abc**

Press "abc" to switch character to uppercase. If "ABC" is pressed again, changes character set into the numbers, symbols, etc.

":&12"

Press "":&12" to switch character to lowercase.

OK

Applies the entered information and closes the software keyboard.

space

Enters a space.

DEL

Erases the character string.

Netflix Help

You can deactivate the Netflix function. Refer to "Smart TV" > "Advanced" > "Netflix Help" and select "Deactivate".

[\(See page 7-13.\)](#)

VUDU Help

To deactivate the VUDU function, refer to "Smart TV" > "Advanced" > "VUDU Help" and select "Yes".

[\(See page 7-13.\)](#)

Example

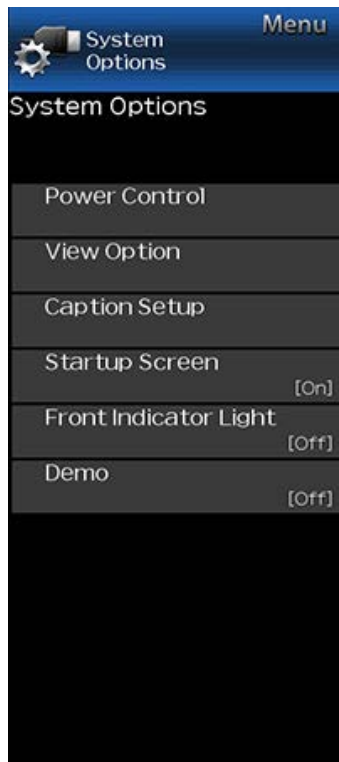

System Options

NOTE

- For operating the on-screen display menu, [see page 4-3](#).

Power Control

Power control setting allows you to save energy.

No Signal Off

When this function is enabled, the TV automatically shuts down if no signal is received for more than 15 minutes.

NOTE

- When it is 5 minutes before the power shuts down, the remaining time will start to keep appearing every minute.
- When a TV program finishes, this function may not operate.

No Operation Off

When you enable this function, the TV automatically shuts down if no operation is performed for more than 3 hours.

NOTE

- When it is 5 minutes before the power shuts down, the remaining time will start to keep appearing every minute.

View option

View Mode

This function changes the screen size. The View Mode menu varies depending on the input source.

Change Audio

MPX

Allows you to change the audio when multiple audio is available for the program you are watching.

NOTE

- You can change Audio by pressing AUDIO on the remote control unit. [See page 3-8](#) for details of Audio function.

Audio Only

When listening to music from a music program, you can turn the screen off and enjoy audio only.

NOTE

- The screen image will return to normal when a button (except those for audio adjustment, such as **VOL**, **MUTE**) is presses.

Change CC

Allows you to change the Closed Caption display. Select "Change CC" on the menu to display the Closed Caption information.

- The information displayed varies depending on the program you are watching.

NOTE

- You can change Closed Caption by pressing **CC** on the remote control unit. [See pages 3-12 to 3-13](#) for details of Closed Caption function.

Example

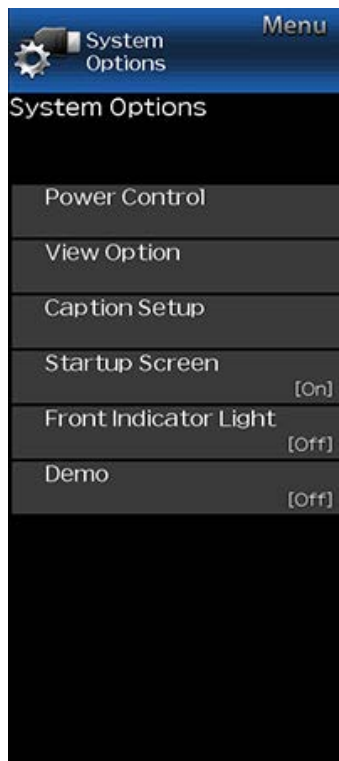

System Options (Continue)

Caption Setup

Mode

Select "Custom" to adjust the closed caption screen appearance to suit your preference.

Size/Edge Effect/Edge Color/Text Color/Background Color/Text Opacity/Background Opacity

NOTE

- The default value depends on the broadcasting station.

Startup Screen

With this function activated, the SHARP logo will be displayed when you turn on the TV.

NOTE

- This function is not available when the TV is set to "Quick Start Mode".

Front Indicator Light

When this function is set to "On", the LED on the front of the TV turns on.

NOTE

- "On" is the factory preset value. If you want to turn off the LED, set the function to "Off".

Demo

With this function activated, you can select the image from several types of demo mode.

NOTE

- What kinds of setting item are available depends on the model of your TV.
- "Demo" may not be selected depending on input signal type or application status.
- "Demo" may be automatically canceled depending on input signal type.

Preparation

You can connect the TV to a USB memory device, USB hard drive or Home Network server to enjoy viewing pictures, listening to music, and watching videos.

NOTE

- Depending on the USB memory device/USB hard drive/Home Network server, the TV may not be able to recognize the recorded data.
- It may take time to read the recorded data if the USB memory device/USB hard drive/Home Network server contains many files or folders.
- Use only alphanumeric characters for naming files.
- File names over 80 characters (may vary depending on character set) may not be displayed.

Connecting a USB Memory Device/USB Hard Drive

Insert the USB memory device with recorded photos, music or videos into the USB terminal on the TV.

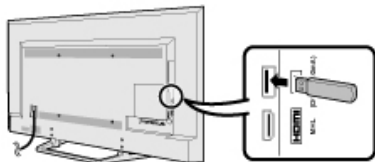

- When connecting a USB hard drive, be sure to use a hard drive with an AC adapter.
- Do not remove a USB memory device or memory card from the TV while transferring files, using the slide show function, or switching screens, or before you exit "USB" from the INPUT list.
- Do not insert and remove a USB memory device/USB hard drive to and from the TV repeatedly.
- When using a card reader, be sure to insert a USB memory device first.

CAUTION

- Do not use a USB extension cable when connecting a USB memory device to the USB terminal on the TV.
- Using a USB extension cable with the USB memory device may prevent the TV from performing correctly.

Connecting a Home Network Server

Connect the TV to the Home Network server using an ETHERNET cable.

- You can also connect a Home Network server by using a wireless LAN.

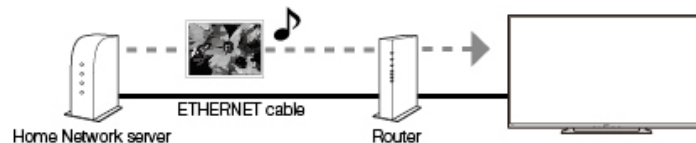

NOTE

- Do not disconnect a Home Network server from the TV while transferring files, when a screen is switching to another or before you exit "Home Network" from the INPUT list.
- Do not connect and disconnect a Home Network server from the TV repeatedly.

Enjoying Photo/Music/Video Playback



Selecting the Folders to Play Back

- To play back data on a USB memory device, insert the USB memory device on the TV.
- Use the following procedure to switch back to USB mode after switching from USB mode to another mode.
 - 1 Select "USB" or "Home Network" from INPUT list screen.
 - 2 Press to select "Video", "Music" or "Photo", and then press **ENTER**.

Example



- 3 Press to select the desired folder, and then press **ENTER**.
 - "VIEW MODE" is fixed during the Music mode. During "Video mode", you can select "AUTO", "ORIGINAL" or "Stretch".
 - During "Video mode", videos that are smaller than the number of pixels on the screen are displayed at their original size. In these cases, switch "VIEW MODE" to "AUTO" to have the video fill the screen.

NOTE

- You can also directly switch to the USB input source by pressing **USB** on the remote control.
- The Media screen can be displayed even by using the application window. To display the application window, press **SMART**. [\(See page 3-6.\)](#)
- 16 is the maximum number of USB drives and 10 is the maximum number of Home Network servers that can be displayed.

USB Device Compatibility

USB device	USB Memory, USB card reader (Mass Storage class), USB hard drive
File system	FAT/FAT32/NTFS (USB hard drive only)
Photo file format	JPEG (.jpg) (DCF2.0 compliant)
Music file format	MP3 (.mp3) Bitrate: 32k, 40k, 48k, 56k, 64k, 80k, 96k, 112k, 128k, 160k, 192k, 224k, 256k, 320kbps Sampling frequency: 32k, 44.1k, 48kHz

Enjoying Photo/Music/Video Playback



Selecting the Folders to Play Back (Continue)

Video file format			
File extension	Container	Video	Audio
.avi	AVI	MPEG-1 MPEG-4 SP/ASP(XviD) MPEG-4 AVC (H.264) Motion JPEG	MPEG-Audio LPCM MS-ADPCM AC3
.mkv	MKV	MPEG-1 MPEG-2 MPEG-4 SP/ASP(XviD) MPEG-4 AVC (H.264)	MPEG-Audio LPCM MS-ADPCM AC3
.asf .wmv	ASF WMV	MPEG-4 SP/ASP(XviD) WMV 7/8/9	LPCM WMA
.mp4	MP4	MPEG-4 SP/ASP(XviD) MPEG-4 AVC (H.264) Motion JPEG	MPEG-Audio LPCM MS-ADPCM AC3
.mpg .mpeg	MPG	MPEG-1 MPEG-2	MPEG-Audio LPCM MS-ADPCM AC3

NOTE

- Progressive format jpeg files are not supported.
- USB 1.1 devices may not be played properly.
- Operation using USB hubs is not guaranteed.
- Some video file formats may not be played depending on the file.
- Some images may not be displayed in the appropriate aspect ratio depending on the file format.

Home Network Server Compatibility

Photo file format	JPEG
Music file format	LPCM, MP3
Video file format	AVI, MKV, ASF, MP4, WMV, MPG

NOTE

- Progressive format jpeg files are not supported.
- Some video file formats may not be played depending on the file or the server.
- WMV, ASF, MP4, MOV and AVI are not Home Network contents.



Enjoying Photo/Music/Video Playback



Playing Back Files on a USB Memory Device/Home Network Server

NOTE

- The screen images in this section are for the USB mode. It may be slightly different in the Home Network mode.

Photo Mode

Viewing Thumbnails

Example



Buttons for thumbnail operations

Buttons	Description
▲▼▶◀	Select a desired item.
ENTER	When selecting a folder icon: Enter this directory. When selecting a photo thumbnail: Start the slide show.
RETURN	Return to the previous process.
A (red)	Clear the file information display.
B (green)	
C (blue)	
D (yellow)	

NOTE

- A few seconds after the cursor is positioned on a thumbnail, the file information is displayed in the right of the center of the screen.

Playing Back Files on a USB Memory Device/Home Network Server (Continue)

Slide Show

The photos displayed on the thumbnail selection screen are displayed as a slide show.

Buttons for slide show operation

Buttons	Description
RETURN	Return to the thumbnail selection screen.
B (green)	Previous file
C (blue)	Displaying/hiding operation guidance
D (yellow)	Next file

NOTE

- Rotating photos only applies to the temporarily selected item and this setting is not saved.





Playing Back Files on a USB Memory Device/Home Network Server (Continue)

Music Mode

Example

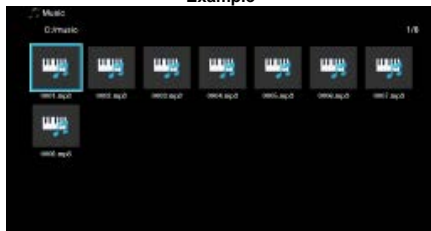

Buttons for music mode

Buttons	Description
▲▼◀▶	Select a desired item.
ENTER	When selecting a folder icon: Enter this directory. When selecting a music file: Play music.
RETURN	Return to the previous process.
A (red)	Clear the file information display.
B (green)	
C (blue)	
D (yellow)	

NOTE

- The displayed play time may differ slightly from the actual play time depending on the files.
- A few seconds after the cursor is positioned on a thumbnail, the file information is displayed in the right of the center of the screen.



Playing Back Files on a USB Memory Device/Home Network Server (Continue)

Video Mode

Example

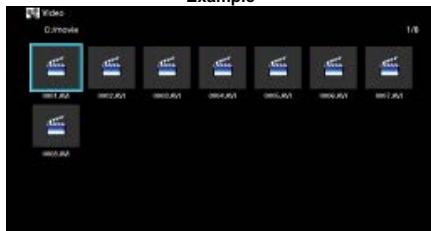

Buttons for file selecting operations

Buttons	Description
▲▼◀▶	Select a desired item.
ENTER	When selecting a folder icon: Enter this directory. When selecting a video file: Play the video.
RETURN	Return to the previous process.
A (red)	Clear the file information display.
B (green)	
C (blue)	
D (yellow)	

NOTE

- A few seconds after the cursor is positioned on a thumbnail, the file information is displayed in the right of the center of the screen.

>>

Enjoying Photo/Music/Video Playback

<<



Playing Back Files on a USB Memory Device/Home Network Server (Continue)

Buttons for playing mode

Buttons	Description
▶	Fast forward
◀	Fast rewind
A (red)	Subtitle off
B (green)	Previous file
C (blue)	Display/hide operation guide
D (yellow)	Next file
RETURN	Go back to the file selection screen.

Controlling HDMI Equipment Using LINK Operation

What's LINK Operation?

- Using the HDMI CEC (Consumer Electronics Control) protocol, with LINK Operation you can interactively operate compatible system equipment (Blu-ray disc equipment, AV amplifier, DVD).
- To access this function: System Operation > Initial Setup > Input Settings > Link Setup > Link Operation.

NOTE

- For connecting the TV to LINK-compatible equipment, use commercially available cables.
- Point the remote control toward the TV, not to connected HDMI equipment.
- Video noise may occur depending on the type of HDMI cable used. Make sure to use an HDMI-certified cable.
- Up to 3 pieces of HDMI recording equipment and one AV amplifier can be connected using this system.
- These operations affect the HDMI equipment selected as the current input source. If the equipment does not operate, turn on the equipment and select the appropriate input source using **INPUT**.
- The LINK feature may not operate properly when an HDMI splitter or AV selector unit is used. These devices may cause interruptions to the image and/or sound.

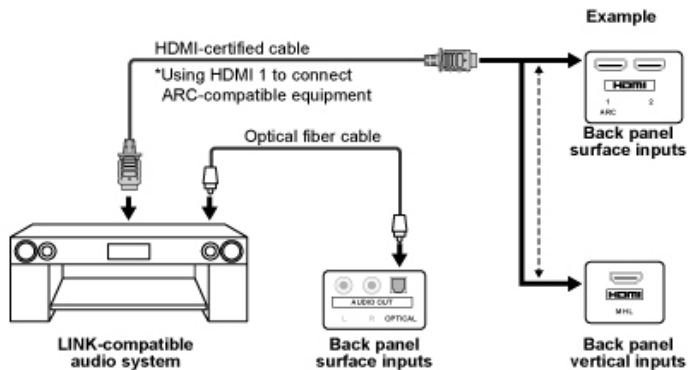

Connected LINK-compatible devices can be operated without changing the settings of the remote control unit.

Control the LINK-compatible audio system

Set the volume of LINK-compatible audio system.

NOTE

- The steps in "LINK Setup" on [page 6-2](#) need to be completed beforehand.
- Refer to this operation manual and the operation manual of the LINK device to be used with this TV.

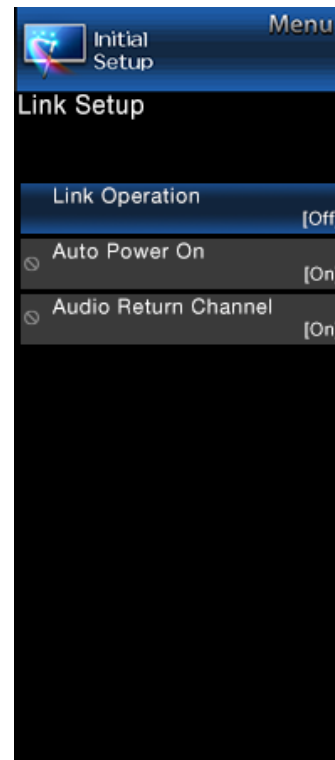



Controlling HDMI Equipment Using LINK Operation (Continue)

LINK Setup

Make the settings to use LINK Operation. Set the settings with "Initial Setup" > "Input Settings" > "LINK Setup".

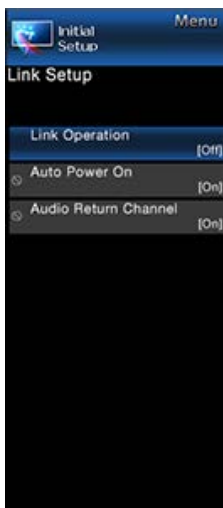

Link Operation

Select LINK Operation Control to disable the LINK function even when a LINK-compatible HDMI device is connected to the TV. This function prevents the device from starting to operate unexpectedly.

Auto Power On

If this is activated, the One Touch Play function is enabled. While the TV is in standby mode, it automatically turns on and plays back the image from the HDMI source.

Audio Return Channel

This function allows you to listen to the TV audio via audio equipment without using an optical fiber cable, which conventionally is required.

Requirements for using an ARC-compatible AV amplifier:

- ARC-compatible AV amplifier connected to the ARC-compatible HDMI terminal. (HDMI 1)
(Refer to the operation manual of the ARC-compatible equipment for details.)
- Use of an ARC-compatible cable.

Auto: You can listen to the TV audio with ARC-compatible audio equipment.

Off: This function does not work.

NOTE

- If the TV audio cannot be output from the AV amplifier even after making the necessary settings, connect the TV to the AV amplifier with an optical fiber cable and select "Off".



Using a Smartphone with the TV

This function enables you to connect the TV to a smartphone that supports Mobile High-Definition Link (MHL™) using an MHL cable.

To connect the TV to your MHL-compatible smartphone, be sure to use an MHL cable (commercially available).

- You can view pictures and video on a large screen.
- You can play back music files.

NOTE

- An MHL-compatible portable device is required to use this function. Connect the device to the HDMI IN 3 terminal.
- This product incorporates MHL 1.

Auto Input Selection

When an MHL-compatible device is connected while the TV is on, the input mode is selected automatically.

- This function operates when "LINK Operation" is set to "On".

[\(See page 6-2.\)](#)

Operation Using the Remote Control

The remote control of the TV can be used to operate a portable device.

- ▲▼◀▶, ENTER, EXIT, 0-9, • (DOT), ENT, etc.
- The operations vary depending on the connected equipment and content being viewed.

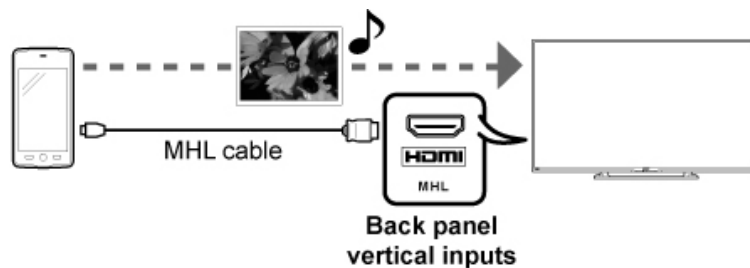

By connecting your TV to a broadband system, you can access the Internet from the TV.

- You can enjoy a variety of streaming content and Internet applications.
(See pages 7-12 to 7-13.)

Connecting to the Internet

- To connect your TV to the Internet, you must have a broadband Internet connection.
- If you do not have a broadband Internet connection, consult the store where you purchased your TV or ask your Internet service provider or telephone company.
- When an Internet connection is made, an Ethernet and wireless connection cannot be used at the same time. Use only one of the connection types.

Using an ETHERNET cable

Use an ETHERNET cable (commercially available) to connect the ETHERNET terminal on the TV to your broadband router (commercially available).



Using the wireless LAN

This TV is equipped with a wireless LAN function.

For a wireless LAN connection, you must use "Wireless Setup" to connect the access point and TV.



NOTE

- This TV has a built-in wireless LAN function. Using a separate wireless USB LAN adapter may result in radio communications that do not comply with regulations on radio communications. Therefore, do not use a separate wireless LAN adapter.
- A wireless LAN connection and performance cannot be guaranteed for all residential environments. In the following cases, the wireless LAN signal may be poor or drop, or the connection speed may become slower.
 - When used in buildings made with concrete, reinforced steel, or metal
 - When placed near objects that obstruct the signal
 - When used with other wireless devices that emit the same frequency
 - When used in the vicinity of microwave ovens and other devices that emit a magnetic field, electrostatic charge, or electromagnetic interference
- When there is significant interference in the 2.4-GHz frequency (such as from other wireless LAN devices, Bluetooth® devices, 2.4-GHz cordless telephones, and microwave ovens), it is recommended that you use a wireless LAN router/access point that supports IEEE802.11a/n (5 GHz) and set the access point to transmit at 5 GHz. For setup details, see the operation manual of your access point.



Internet Setup

Perform the procedure below to make adjustments or to confirm the settings for accessing the Internet.

- 1 Press **MENU** to display the MENU screen, and then press **ENTER**.
- 2 Press **◀▶** to select "Smart TV", and then press **ENTER**.
- 3 Press **▲▼** to select "Internet Setup", and then press **ENTER**.
- 4 Press **▲▼** to select "Connection Type", "Wired Setup" or "Wireless Setup", and then press **ENTER**.
 - Select "Wired Setup" or "Wireless Setup" when you make general adjustments to connect to the Internet.
- 5 Press **▲▼** to select a specific item, and then press **ENTER**.
- 6 Press **▲▼** (or **◀▶**) to select the desired setting, and then press **ENTER**.
- 7 Press **MENU** to exit.

Connection Type

Select the connection type.

Wired: The signal is detected and setup is performed automatically. Use "IP Setup" to check and change the settings as necessary.

Wireless: Configure the access point settings on "Wireless Setup".



Internet Setup (Continue)

Wireless Setup

Make adjustments and confirm the settings necessary for wireless LAN connection (such as search for the access point and registration of it).

WPS push button: Allows the TV to automatically establish the connection using a button on the access point.

WPS PIN code: Sets up the connection by registering a PIN code for the access point.

Selecting wireless network: Searches for and selects the access point to be connected.

Registering wireless network: Allows you to make the connection by entering an SSID for the access point. If your access point supports Wi-Fi Protected Setup (WPS push button method), it is recommended that you use this function for the wireless connection. You can press the WPS button on the access point to configure the settings automatically.

- The name of the WPS button function may differ depending on the access point. See the operation manual of the access point for details.

1 Confirm the current settings in "Connection Type".

- If "Wired" is selected, press **▲▼** to select "Wireless".

2 Press **▲▼** to select "Wireless Setup", and then press **ENTER**.

- Confirm the settings. If each setting item is correct, press **MENU** to exit.
- If you are configuring the wireless setup for the first time or changing the settings, go to step 3.

3 Press **◀▶** to select "Change", and then press **ENTER**.

4 Select the desired connection method and follow the instructions shown on the display.

5 When a connection is established, the connection details are displayed. Press **ENTER**.

NOTE

- Operations cannot be guaranteed when used with access points that do not have Wi-Fi® certification.
- A wireless LAN router/access point is required to connect the TV to the Internet using a wireless LAN. See the operation manual of your access point for setup.
- If your access point is set to a stealth mode (that prevents detection by other devices), you may not be able to establish a connection. In this case, disable the stealth mode on the access point.
- A stable connection speed is required to play back streaming content. Use an Ethernet connection if the wireless LAN speed is unstable.
- Before transferring to a third party or disposal, be sure to initialize the wireless LAN settings.
- Please follow the legislation in your country when using the wireless LAN outdoors.

IP Setup

You can make adjustments manually for the IP.

- Check that numbers are displayed for each setting.
- If there are any settings without numbers, specify the numbers by following the on-screen instructions.
- Input the IP address by using remote control buttons 0-9.

Example

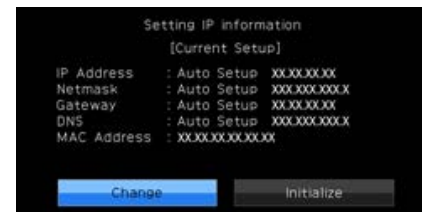



Internet Setup (Continue)

Connection Test

After the connecting and setting procedures have been completed, you can check that the preparation is correct. Press "Yes" to start the "Connection Test".

- When the test results are displayed, follow the instructions shown on the screen.



Entering Text (Software Keyboard)

When you are editing an input screen or specifying the Network settings used for accessing the Internet, enter text from the software keyboard.

NOTE

- You can enter up to 128 characters for text.
- Some special characters or diacritics may not be available depending on where you enter the text.

The text you enter is displayed as you type it in.

To move the cursor (the current input position), use "**<-**" or "**->**" on the software keyboard.

Clear	http://	www.	.com	.org	.cn	Close						
English	1	2	3	4	5	6	7	8	9	0	Enter	
CapsLock	Q	W	E	R	T	Y	U	I	O	P	Space	
<-	->	A	S	D	F	G	H	J	K	L	/	Symbol
BackSpace	Z	X	C	V	B	N	M	.	1/1	Delete		

While you are entering text, likely input conversion candidates are displayed based on what you typed in.

CapsLock

If "alphabet" is selected, this switches characters between uppercase and lowercase.

Each time you press **ENTER**, the character type switches.

Symbol

Press **ENTER** to select the type of characters entered: alphabet, or sign.

BackSpace/Delete

Erases text one character at a time.



Entering Text (Software Keyboard) (Continue)

Enter

Applies the entered information and closes the software keyboard.

Space

Enters a space.

Clear

Erases the character string.

- When the cursor is somewhere in a line: the character string to the right of the cursor will be erased.
- When the cursor is at the right end of a line: the entire line will be erased.

Close

Closes the software keyboard without applying the entered information.

Buttons on the remote control unit	Description
▲▼◀▶	Moves the focus. When moved at the far edge, the focus moves to the opposite edge.
ENTER	Performs the processing for the button currently in the focus.
EXIT	Closes the software keyboard without applying the original input elements for the entered text.
RETURN	
0-9	Directly enters the single-byte number for that button.



Using the Browser

- 1 Press **SMART**, press **◀▶** to select the browser icon from the application window, and then press **ENTER**.
 - Press **SMART** again to switch back to the currently tuned channel.

Buttons for Using the Browser

ENTER, ▲▼/◀▶

- Press **▲▼/◀▶** to select a link that you want to jump, and then press **ENTER**.

EXIT

- Press the button to return to the TV screen.

RETURN

- Press the button to return to the previous page.

NOTE

- Restrictions apply to window display.



Using the Browser (Continue)



Selected item	Description
	Allows you to go back to the previous page.
	Allows you to go to the next page.
	Refreshes the page. Interrupts a page while it is loading.
	Displays the home page.

Selected item	Description
	Displays the bookmarks list.
	Displays your browsing history.
	Configures browser settings.

Using the Toolbar

You can use the toolbar to control the browser and to specify settings.

- 1 Press to select a function, and then press **ENTER**.

Browsing Web Contents

You can display the web content you want to enjoy.

- 1 Press to move to the address area in the toolbar, and then press **ENTER**.
 - The Enter Address menu is displayed.
- 2 Enter an address, and then press **ENTER**.
 - The web content you want to view is displayed.



Using the Browser (Continue)

CAUTION

- If the power is cut due to a power failure or the TV being unplugged while you are using the Internet, information such as bookmarks or cookies may not be saved correctly.

To users who access the Internet from a PC

- When you access the Internet from this TV, the procedures may not be the same as regular browser-based access on a PC.
- On some pages, video and audio, text or images may not be displayed correctly.

About links

- Web pages on the Internet often include "links" that allow you to jump to other web pages (or sites).
- "Links" can take various forms, including words or images, but they always work in the same way letting you jump to the link destination when you select them.
- Selected items (such as links of text input fields) are enclosed in a frame.
- You can jump from a "link" to the corresponding link destination.

DISCLAIMERS

SHARP corporation bears no responsibility regarding the content and quality of the content provided by the content serve provider.



Using the Browser (Continue)

Browser Settings

You can check or modify your browser settings from the Browser menu.

- 1 Press to select "  " in the toolbar, and then press **ENTER**.
- 2 Press to specify the required setting, and then press **ENTER**.



Using Keyboard and Mouse

You can use a keyboard or mouse for operating the TV while using the browser.

- When you use the USB devices, connect the device to the USB terminal on the TV.

NOTE

- The keyboard and mouse can only be used on a browser screen.

The keyboard or mouse may not operate properly depending on the application being used.



Using Applications via the Internet

By connecting the TV to the Internet, you can enjoy a variety of broadband content, including videos, music and photos.



Please check that the most current software is loaded on TV by selecting "Auto Update Setting" on "Software Update"
([see page 4-14](http://www.sharpusa.com/products/support/)) or by visiting
<http://www.sharpusa.com/products/support/>
to check for a download of the newest software version.

Use the application window to access your favorite Internet applications. Press **SMART** to display the application window.

Follow the on-screen instructions for each application.

- When using this TV to access an Internet application for the first time, the Disclaimer appears on the screen. Press **▲▼** to select "Agree", and then press **ENTER**. (You must select "Agree" to use the application.)
- Check the web site of the provider for details on setup and use of the functions.

NOTE

- If  or  is displayed, check your TV's network settings and connection.
- Additional applications will be available in the future.
- These applications are provided by content providers. The available applications vary depending on your country or region.
- The delivery speed of applications varies depending on the network speed. Check the web site of the provider for details on application setup and other information.

Using the Application Window

During Dock Display

You can move the application icons.

Example



1 Press **◀▶** to select an application, and then press **▲**

2 Press **◀▶** to move the icon to the desired location.

Move the Icons

You can move the icons of the more commonly used applications closer to the left.

Press **◀▶** to move the icon to the desired location.

Saving Favorite Applications

You can set your favorite applications to the **FAV APP 1**, **2**, and **3** buttons on the remote control for easier startup. The applications whose icons are moved onto **1**, **2** and **3** during Dock Display will be assigned to the **FAV APP 1**, **2** and **3** buttons respectively.



Using Applications via the Internet (Continue)

Deactivating Netflix Function

You can deactivate the Netflix function. Refer to "Smart TV" > "Advanced" > "Netflix Help" and select "Deactivate".

- To confirm the Netflix status, check the information displayed on the screen and click "OK".

Deactivating the VUDU Function

To deactivate the VUDU function, refer to "Smart TV" > "Advanced" > "VUDU Help" and select "Yes". When you access the Internet application for the first time, the following appears.

- This message is available only in English.

AQUOS Advantage Live

When you select this app on the SmartCentral screen, you can use the remote support function from the support center and display the network status.

DISCLAIMERS

- This SHARP device facilitates the access to content and services provided by third parties. The content and services accessible via this device belong to and may be proprietary to third parties. Therefore, any use of such third party content and services must be in accordance with any authorization or terms of use provided by such content or service provider. SHARP shall not be liable to you or any third party for your failure to abide by such authorization or terms of use. Unless otherwise specifically authorized by the applicable content or service provider, all third party content and services provided are for personal and non-commercial use; you may not modify, copy, distribute, transmit, display, perform, reproduce, upload, publish, license, create derivative works from, transfer or sell in any manner or medium any content or services available via this device.
- SHARP is not responsible, nor liable, for customer service-related issues related to the third party content or services. Any questions, comments or service-related inquiries relating to the third party content or service should be made directly to the applicable content or service provider.
You may not be able to access content or services from the device for a variety of reasons which may be unrelated to the device itself, including, but not limited to, power failure, other Internet connection, or failure to configure your device properly. SHARP, its directors, officers, employees, agents, contractors and affiliates shall not be liable to you or any third party with respect to such failures or maintenance outages, regardless of cause or whether or not it could have been avoided.
- ALL THIRD PARTY CONTENT OR SERVICES ACCESSIBLE VIA THIS DEVICE IS PROVIDED TO YOU ON AN "AS-IS" AND "AS AVAILABLE" BASIS AND SHARP AND ITS AFFILIATES MAKE NO WARRANTY OR REPRESENTATION OF ANY KIND TO YOU, EITHER EXPRESS OR IMPLIED, INCLUDING, WITHOUT LIMITATION, ANY WARRANTIES OF MERCHANTABILITY, NON-INFRINGEMENT, FITNESS FOR A PARTICULAR PURPOSE OR ANY WARRANTIES OF SUITABILITY, AVAILABILITY, ACCURACY, COMPLETENESS, SECURITY, TITLE, USEFULNESS, LACK OF NEGLIGENCE OR ERROR-FREE OR UNINTERRUPTED OPERATION OR USE OF THE CONTENT OR SERVICES PROVIDED TO YOU OR THAT THE CONTENT OR SERVICES WILL MEET YOUR REQUIREMENTS OR EXPECTATIONS.
- SHARP IS NOT AN AGENT OF AND ASSUMES NO RESPONSIBILITY FOR THE ACTS OR OMISSIONS OF THIRD PARTY CONTENT OR SERVICE PROVIDERS, NOR ANY ASPECT OF THE CONTENT OR SERVICE RELATED TO SUCH THIRD PARTY PROVIDERS.
- IN NO EVENT WILL SHARP AND/OR ITS AFFILIATES BE LIABLE TO YOU OR ANY THIRD PARTY FOR ANY DIRECT, INDIRECT, SPECIAL, INCIDENTAL, PUNITIVE, CONSEQUENTIAL OR OTHER DAMAGES, WHETHER THE THEORY OF LIABILITY IS BASED ON CONTRACT, TORT, NEGLIGENCE, BREACH OF WARRANTY, STRICT LIABILITY OR OTHERWISE AND WHETHER OR NOT SHARP AND/OR ITS AFFILIATES HAVE BEEN ADVISED OF THE POSSIBILITY OF SUCH DAMAGES.

Examples of Application Logos

NETFLIX



CinemaNow

YouTube



Miracast devices

When you connect a device such as a Miracast-compatible smartphone or tablet to this TV, you can enjoy video and audio from the device on the TV's large screen and speakers.

- 1 Select the "Smart TV" > "Miracast".
- 2 Enable the Miracast function on the Miracast device and connect to the TV.
(The TV screen changes according to the behavior of the device)

NOTE

- When the TV is turned off or the connection is ended on the device, you must connect the device again.
- For details about the operation of the Miracast-compatible device, check the manual for that device.
- When the Miracast device is connected to the TV over a wireless LAN, Miracast video may be distorted and Miracast audio may be interrupted depending on the status of the TV's connection to the access point.

Removing the Stand

- Before detaching (or attaching) the stand, make sure to turn off the TV and unplug the AC cord.

CAUTION

- Do not remove the stand from the TV unless using an optional wall mount bracket to mount it.

- 1 Unfasten the four screws used to secure the stand in place.

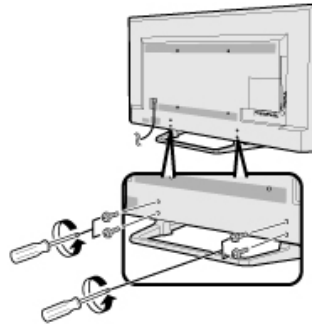
Example

- 2 Detach the stand from the TV.

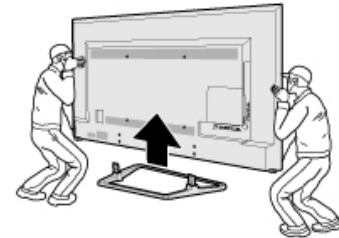
**NOTE**

- Be sure to always carry the TV by two people holding it with two hands.
- In the installation procedure, be careful not to catch your fingers between the TV set and the floor.

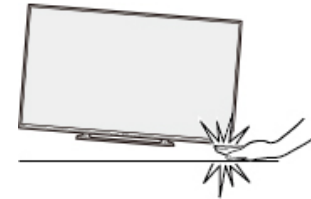

Setting the TV on the Wall

Wall Mount Kit Specifications

Standard dimensions for wall mount kits are shown below.

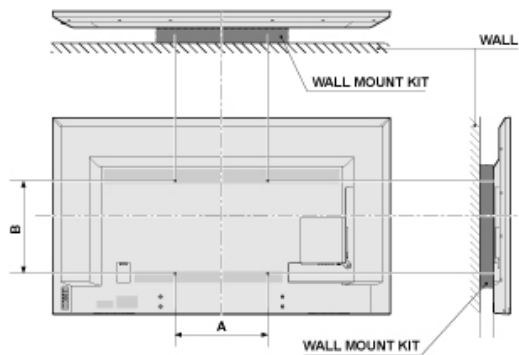

* The mounting means should be strong enough to bear the weight of the display.

* The wall mounting bracket should have UL or related approval.

Model	LC-65LE654U	LC-55LE653U	LC-48LE653U	LC-43LE653U
Wallmount Footprint (A x B)	400 x 400mm		200 x 200mm	
Wallmount Screws	M6			

Setting the TV on the Wall(Continue)

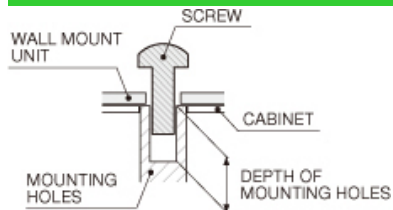

For the screws, refer to the table shown below.

Standard screws	M6 (Use 1.0 pitch screws.)
Length(Depth of mounting holes)	15/32 (12)
Quantity	4 pcs.

NOTE

- Do not mount the TV at a tilt.
- To use this TV mounted on a wall, remove the cable tie as needed.
- Do not use screws that do not comply with the VESA standard screw specifications.
- Do not use screws that are longer than the standard length. Screws that are too long may cause damage to the inside of the TV.
- Do not fasten the screws too firmly or loosely. This may damage the product or cause the product to fall, leading to personal injury. SHARP is not liable for these kinds of accidents.
- SHARP is not liable for product damage or personal injury when a non-VESA or non-specified wall mount is used or the consumer fails to follow the product installation instructions.



Do not install the wall mount kit while your TV is turned on. It may result in personal injury due to electric shock.

Troubleshooting

Problem	Possible Solution
<ul style="list-style-type: none"> No power 	<ul style="list-style-type: none"> Check if you pressed POWER on the remote control unit. Is the AC cord disconnected? Has the power been turned on?
<ul style="list-style-type: none"> Unit cannot be operated. 	<ul style="list-style-type: none"> External influences such as lightning, static electricity, may cause improper operation. In this case, operate the unit after first turning off the power of the TV or unplugging the AC cord and replugging it in after 1 or 2 minutes.
<ul style="list-style-type: none"> Remote control unit does not operate. 	<ul style="list-style-type: none"> Is the equipment to be operated by the remote control unit set correctly? Press TV to set the remote control unit to the setting for operating the TV. Are batteries inserted with polarity (+, -) aligned? Are batteries worn out? (Replace with new batteries.) Are you using it under strong or fluorescent lighting? Is a fluorescent light illuminated near the remote control sensor?
<ul style="list-style-type: none"> Picture is cut off/with sidebar screen. 	<ul style="list-style-type: none"> Are screen mode adjustments such as picture size made correctly? Pages 3-14 to 3-16
<ul style="list-style-type: none"> Strange color, light color, or color misalignment 	<ul style="list-style-type: none"> Adjust the picture tone. Pages 4-17 to 4-20 Is the room too bright? The picture may look dark in a room that is too bright.
<ul style="list-style-type: none"> Power is suddenly turned off. 	<ul style="list-style-type: none"> Is the sleep timer set? Pages 3-9 Check the power control settings. Page 4-25 The unit's internal temperature has increased. Remove any objects blocking vent or clean.

Problem	Possible Solution
<ul style="list-style-type: none"> No picture 	<ul style="list-style-type: none"> Is connection to other components correct? Is the correct input selected? Pages 2-1 Is "On" selected in "Audio Only"? Page 4-25 If the PC image is not displayed, check the following: <ul style="list-style-type: none"> When connecting a laptop PC to the TV, check that display output mode of the PC is set to external monitor.
<ul style="list-style-type: none"> Picture quality of HD programs is poor. 	<ul style="list-style-type: none"> To enjoy HD images from external equipment, you are required to set up HDMI connection or component connection. If the program content is not of HD quality, HD images cannot be displayed. Check that the program you are viewing provides HD images. The HD cable/satellite set-top box may need to be configured to output HD images via cable/satellite. The cable/satellite broadcast may not support a signal resolution of 1080p.
<ul style="list-style-type: none"> The TV sometimes makes a cracking sound. 	<ul style="list-style-type: none"> This is not a malfunction. This happens when the cabinet slightly expands and contracts according to change in temperature. This does not affect the TV's performance.
<ul style="list-style-type: none"> Some Internet functions used on a PC are not available from the TV. 	<ul style="list-style-type: none"> The TV has only limited functions compared with regular PC browsers. Pages 7-7 to 7-9

Troubleshooting (Continue)

Problem	Possible Solution
<ul style="list-style-type: none"> No sound 	<ul style="list-style-type: none"> Is connection to other components correct? Is the volume too low? Page 3-2 Is "Variable" selected in "Output Select"? Page 4-12 Have you pressed MUTE on the remote control unit? Page 3-3 Check the audio output of the connected external equipment. Is the volume too low or muted? When external equipment is connected via an HDMI cable, you may need to configure the audio to be output through the HDMI cable. When audio is not output from external equipment connected to the HDMI 2 terminal, check the "Audio Select" setting. Page 4-12 Even when external equipment is connected using an HDMI-certified cable, an audio cable connection may be required depending on the type of equipment and the media being played back. In this case, in addition to connecting an HDMI-certified cable to the HDMI 2 terminal, connect an RCA audio to Ø 3.5 mm stereo minijack cable to the AUDIO IN terminal and set "Audio Select" to "HDMI 1+ Analog". Page 4-12 When connecting a PC via an HDMI-certified cable, check the following: <ul style="list-style-type: none"> Is the audio output of the PC configured correctly? Check the audio output settings and output audio format in Sound Properties on the PC. The audio formats compatible with this TV are PCM and Dolby Digital. With other formats, audio cannot be output. Depending on the board, only video signals may be output. In this case, in addition to connecting an HDMI-certified cable to the HDMI 2 terminal, connect an RCA audio to Ø 3.5 mm stereo minijack cable to the AUDIO IN terminal and set "Audio Select" to "HDMI 1+ Analog". Page 4-12

Problem	Possible Solution
<ul style="list-style-type: none"> Miracast image/audio cannot be output to the TV. 	<ul style="list-style-type: none"> Check pairing.

Cautions regarding use in high and low temperature environments

- When the unit is used in a low temperature space (e.g. room, office), the picture may leave trails or appear slightly delayed. This is not a malfunction, and the unit will recover when the temperature returns to normal.
- Do not leave the unit in a hot or cold location. Also, do not leave the unit in a location exposed to direct sunlight or near a heater, as this may cause the cabinet to deform and the front panel to malfunction.
Storage temperature: -4°F to +140°F (-20°C to +60°C)



Appendix



Troubleshooting - Error Message

The example of an error message displayed on a screen	Error code	Possible Solution
<ul style="list-style-type: none">An incompatible audio signal has been received. Check the output device settings.	---	<ul style="list-style-type: none">This message is displayed when an audio format other than PCM, DTS or Dolby Digital is input.<ul style="list-style-type: none">- Set the audio output format of connected external HDMI equipment to PCM or Dolby Digital.- Refer to the operation manual of the external equipment for setting details.



Specifications



TV

Item		Model: LC-65LE654U	
LCD panel	Size	65" Class (64 33/64 Diagonal)	
	Resolution	1920x1080	
TV Function	TV-standard (CCIR)	American TV Standard ATSC/NTSC System	
	Receiving Channel	VHF/UHF	VHF 2-13ch, UHF 14-69ch
		CATV	1-135ch (non-scrambled channel only)
		Digital Terrestrial Broadcast (8VSB)	2-69ch
		Digital cable (64/256 QAM)	1-135ch (non-scrambled channel only)
Audio multiplex	BTSC System		
Audio out		10W x 2 (Digital Audio Amplifier)	
Terminals	Back panel vertical side	AUDIO OUT	Audio out (RCA)
		DIGITAL AUDIO OUT	Optical Digital audio out x 1 (PCM/Dolby Digital)
		HDMI 3	HDMI in with HDCP, MHL
		USB	Photo/Music/Video mode, Software update, USB keyboard/mouse, Wallpaper Picture
	Back panel surface side	HDMI 1	HDMI in with HDCP, ARC, Audio in an RCA audio of component/video
		HDMI 2	HDMI in with HDCP
		COMPONENT/VIDEO	COMPONENT in, AV in
		ANT/CABLE	75 Ω Unbalance, F Type x 1 for Analog (VHF/UHF/CATV) and Digital (AIR/CABLE)
		AUDIO IN	Audio in an RCA audio of component/video
		ETHERNET	Network connector
OSD language		English/French/Spanish	
Power Requirement		120V (108~132Vac) at 50/60 Hz	
On Mode Power		100W	
Standby Power Consumption		<0.5W	
Weight	TV + stand	61.7 lbs/28 kg	
	TV only	58.4 lbs/26.5 kg	
Dimensions (W x H x D)(inch)	TV + stand (W x H x D)	57 29/64 x 34 61/64 x 14 23/64	
	TV only (W x H x D)	57 29/64 x 33 27/64 x 2 3/4	
Operating temperature		+32°F to +104°F (0°C to +40°C)	

- As part of policy of continuous improvement, SHARP reserves the right to make design and specification changes for product improvement without prior notice. The performance specification figures indicated are nominal values of production units. There may be some deviations from these values in individual units.
- On Mode Power Consumption is measured according to Energy Star program requirements for televisions.



Specifications



TV

Item		Model: LC-55LE653U	
LCD panel	Size	55" Class (54 39/64 Diagonal)	
	Resolution	1920x1080	
TV Function	TV-standard (CCIR)	American TV Standard ATSC/NTSC System	
	Receiving Channel	VHF/UHF	VHF 2-13ch, UHF 14-69ch
		CATV	1-135ch (non-scrambled channel only)
		Digital Terrestrial Broadcast (8VSB)	2-69ch
		Digital cable (64/256 QAM)	1-135ch (non-scrambled channel only)
Audio multiplex	BTSC System		
Audio out		10W x 2 (Digital Audio Amplifier)	
Terminals	Back panel vertical side	AUDIO OUT	Audio out (RCA)
		DIGITAL AUDIO OUT	Optical Digital audio out x 1 (PCM/Dolby Digital)
		HDMI 3	HDMI in with HDCP, MHL
		USB	Photo/Music/Video mode, Software update, USB keyboard/mouse, Wallpaper Picture
	Back panel surface side	HDMI 1	HDMI in with HDCP, ARC, Audio in an RCA audio of component/video
		HDMI 2	HDMI in with HDCP
		COMPONENT/VIDEO	COMPONENT in, AV in
		ANT/CABLE	75 Ω Unbalance, F Type x 1 for Analog (VHF/UHF/CATV) and Digital (AIR/CABLE)
		AUDIO IN	Audio in an RCA audio of component/video
		ETHERNET	Network connector
OSD language		English/French/Spanish	
Power Requirement		120V (108~132Vac) at 50/60 Hz	
On Mode Power		90W	
Standby Power Consumption		<0.5W	
Weight	TV + stand	39.7 lbs/18 kg	
	TV only	36.4 lbs/16.5 kg	
Dimensions (W x H x D)(inch)	TV + stand (W x H x D)	48 13/16 x 30 25/32 x 13 3/16	
	TV only (W x H x D)	48 13/16 x 28 5/8 x 2 23/32	
Operating temperature		+32°F to +104°F (0°C to +40°C)	

- As part of policy of continuous improvement, SHARP reserves the right to make design and specification changes for product improvement without prior notice. The performance specification figures indicated are nominal values of production units. There may be some deviations from these values in individual units.
- On Mode Power Consumption is measured according to Energy Star program requirements for televisions.



Specifications



TV

Item		Model: LC-48LE653U	
LCD panel	Size	48" Class (47 39/64 Diagonal)	
	Resolution	1920x1080	
TV Function	TV-standard (CCIR)	American TV Standard ATSC/NTSC System	
	Receiving Channel	VHF/UHF	VHF 2-13ch, UHF 14-69ch
		CATV	1-135ch (non-scrambled channel only)
		Digital Terrestrial Broadcast (8VSB)	2-69ch
		Digital cable (64/256 QAM)	1-135ch (non-scrambled channel only)
Audio multiplex	BTSC System		
Audio out		10W x 2 (Digital Audio Amplifier)	
Terminals	Back panel vertical side	AUDIO OUT	Audio out (RCA)
		DIGITAL AUDIO OUT	Optical Digital audio out x 1 (PCM/Dolby Digital)
		HDMI 3	HDMI in with HDCP, MHL
		USB	Photo/Music/Video mode, Software update, USB keyboard/mouse, Wallpaper Picture
	Back panel surface side	HDMI 1	HDMI in with HDCP, ARC, Audio in an RCA audio of component/video
		HDMI 2	HDMI in with HDCP
		COMPONENT/VIDEO	COMPONENT in, AV in
		ANT/CABLE	75 Ω Unbalance, F Type x 1 for Analog (VHF/UHF/CATV) and Digital (AIR/CABLE)
		AUDIO IN	Audio in an RCA audio of component/video
		ETHERNET	Network connector
OSD language		English/French/Spanish	
Power Requirement		120V (108~132Vac) at 50/60 Hz	
On Mode Power		75W	
Standby Power Consumption		<0.5W	
Weight	TV + stand	28.7 lbs./13 kg	
	TV only	26.5 lbs./12 kg	
Dimensions (W x H x D)(inch)	TV + stand (W x H x D)	42 9/16 x 26 19/64 x 10 35/64	
	TV only (W x H x D)	42 9/16 x 24 59/64 x 2 19/32	
Operating temperature		+32°F to +104°F (0°C to +40°C)	

- As part of policy of continuous improvement, SHARP reserves the right to make design and specification changes for product improvement without prior notice. The performance specification figures indicated are nominal values of production units. There may be some deviations from these values in individual units.
- On Mode Power Consumption is measured according to Energy Star program requirements for televisions.



Specifications



TV

Item		Model: LC-43LE653U	
LCD panel	Size	43" Class (42 1/2 Diagonal)	
	Resolution	1920x1080	
TV Function	TV-standard (CCIR)	American TV Standard ATSC/NTSC System	
	Receiving Channel	VHF/UHF	VHF 2-13ch, UHF 14-69ch
		CATV	1-135ch (non-scrambled channel only)
		Digital Terrestrial Broadcast (8VSB)	2-69ch
		Digital cable (64/256 QAM)	1-135ch (non-scrambled channel only)
Audio multiplex	BTSC System		
Audio out		10W x 2 (Digital Audio Amplifier)	
Terminals	Back panel vertical side	AUDIO OUT	Audio out (RCA)
		DIGITAL AUDIO OUT	Optical Digital audio out x 1 (PCM/Dolby Digital)
		HDMI 3	HDMI in with HDCP, MHL
		USB	Photo/Music/Video mode, Software update, USB keyboard/mouse, Wallpaper Picture
	Back panel surface side	HDMI 1	HDMI in with HDCP, ARC, Audio in an RCA audio of component/video
		HDMI 2	HDMI in with HDCP
		COMPONENT/VIDEO	COMPONENT in, AV in
		ANT/CABLE	75 Ω Unbalance, F Type x 1 for Analog (VHF/UHF/CATV) and Digital (AIR/CABLE)
		AUDIO IN	Audio in an RCA audio of component/video
		ETHERNET	Network connector
OSD language		English/French/Spanish	
Power Requirement		120V (108~132Vac) at 50/60 Hz	
On Mode Power		58W	
Standby Power Consumption		<0.5W	
Weight	TV + stand	24.3 lbs./11 kg	
	TV only	21.6 lbs./9.8 kg	
Dimensions (W x H x D)(inch)	TV + stand (W x H x D)	38 5/64 x 23 47/64 x 10 35/64	
	TV only (W x H x D)	38 5/64 x 22 23/64 x 2 53/64	
Operating temperature		+32°F to +104°F (0°C to +40°C)	

- As part of policy of continuous improvement, SHARP reserves the right to make design and specification changes for product improvement without prior notice. The performance specification figures indicated are nominal values of production units. There may be some deviations from these values in individual units.
- On Mode Power Consumption is measured according to Energy Star program requirements for televisions.

>>

Specifications

<<

Wireless LAN

Specification	
Standard	IEEE 802.11b/g/n
Frequency Band	2.412-2.462 GHz
Security	64-bit, 128-bit WEP, TKIP, AES, WPA, WPA2, WPS, IEEE802.11i
Modulation	DBPSK@1Mbps DQPSK@2Mbps CCK@5.5/11Mbps BPSK@6/9 Mbps QPSK@12/18Mbps 16-QAM@24Mbps 64-QAM@48/54Mbps

- SMART is a registered trademark of Sharp Corporation.

- Manufactured under license from Dolby Laboratories. Dolby and the double-D symbol are trademarks of Dolby Laboratories.

- The terms HDMI and HDMI High-Definition Multimedia Interface, and the HDMI Logo are trademarks or registered trademarks of HDMI Licensing LLC in the United States and other countries.

- The Wi-Fi CERTIFIED Logo is a certification mark of the Wi-Fi Alliance.
- The Wi-Fi Protected Setup Mark is a mark of the Wi-Fi Alliance.
- Wi-Fi CERTIFIED Miracast™ and Miracast™ are trademarks of Wi-Fi Alliance.

- This product includes Home Networking Software 'DiXiM' developed by DigiOn, Inc.

- **LCフォント、LCFONT、エルシーフォント** and LC logo mark are registered trademarks of SHARP Corporation. This product is embedded with LC Font technology, which was developed by SHARP Corporation for clearly displaying easy-to-read characters on LCD screens. However, other fonts are used for some screen pages, too.

- Netflix and the Netflix logo are the registered trademarks of Netflix, Inc.

- VUDU™ is a trademark of VUDU, Inc.

- Manufactured under license under U.S. Patent Nos: 5,956,674; 5,974,380; 6,487,535 & other U.S. and worldwide patents issued & pending.

- MHL, the MHL Logo, and Mobile High-Definition Link are trademarks or registered trademarks of MHL LLC in the United States and other countries.
- MHL™

ENERGY STAR® User Information

- For more information on the ENERGY STAR program, you can refer to energystar.gov.
- Leaving the ENERGY STAR home mode or enabling optional features will cause an increase power consumed.
- This product qualifies for ENERGY STAR when "Home" is selected for "TV Location". Setting "TV Location" to "Home" allows the TV to achieve an energy-saving status for household use.



Products that have earned the ENERGY STAR® are designed to protect the environment through superior energy efficiency.



Dimensional Drawings



LC-65LE654U

Unit: inch (mm)
Unité: pouce (mm)
Unidad: pulgada (mm)

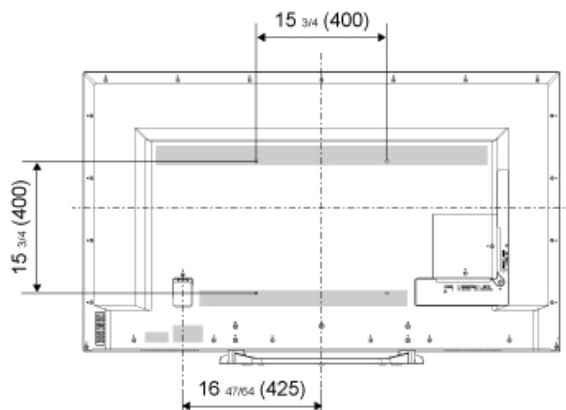
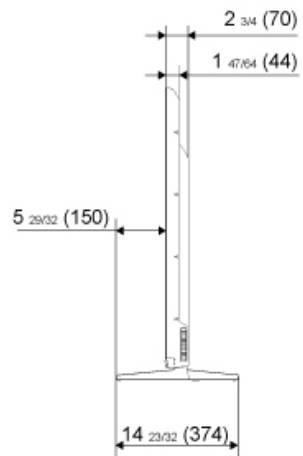
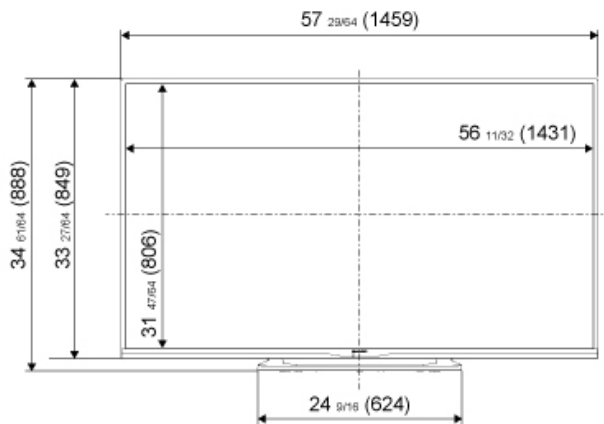

*1 Active area/Área activa/Zone active

*2 Thinnest part/Parte más delgada/Partie la plus mince

*3 Including projecting parts/Incluyendo partes salientes/Parties saillantes incluses



Dimensional Drawings



LC-55LE653U

Unit: inch (mm)
Unité: pouce (mm)
Unidad: pulgada (mm)

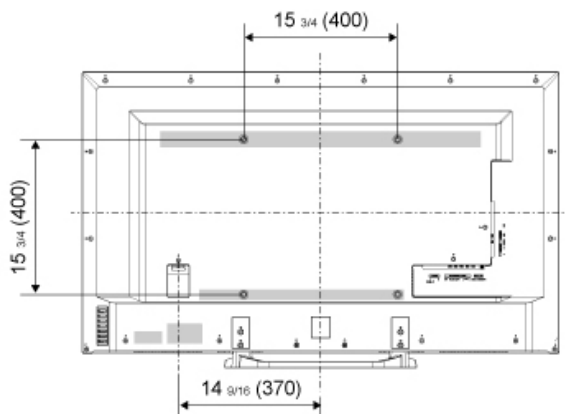
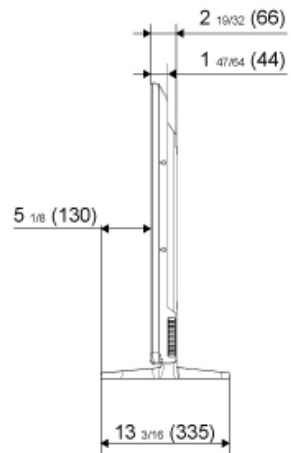
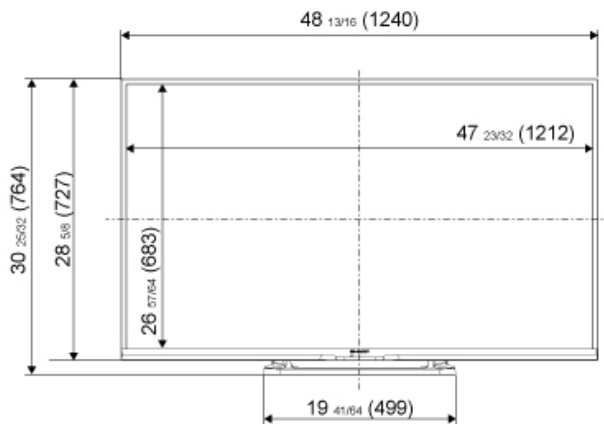

*1 Active area/Área activa/Zone active

*2 Thinnest part/Parte más delgada/Partie la plus mince

*3 Including projecting parts/Incluyendo partes salientes/Parties saillantes incluses



Dimensional Drawings



LC-48LE653U

Unit: inch (mm)
Unité: pouce (mm)
Unidad: pulgada (mm)

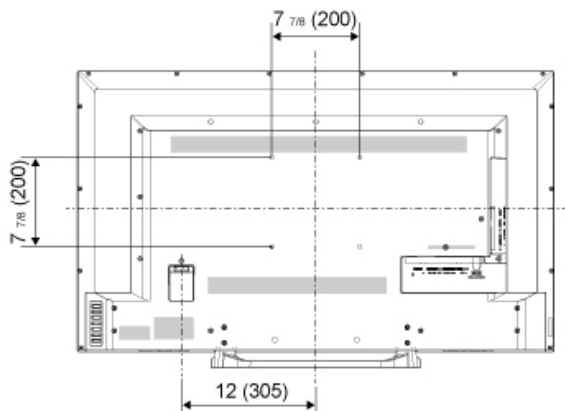
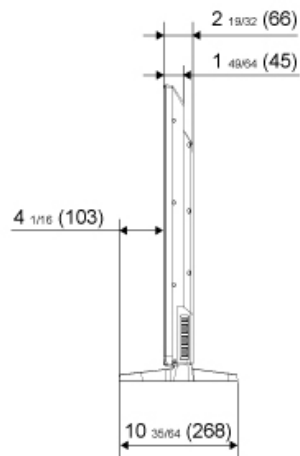
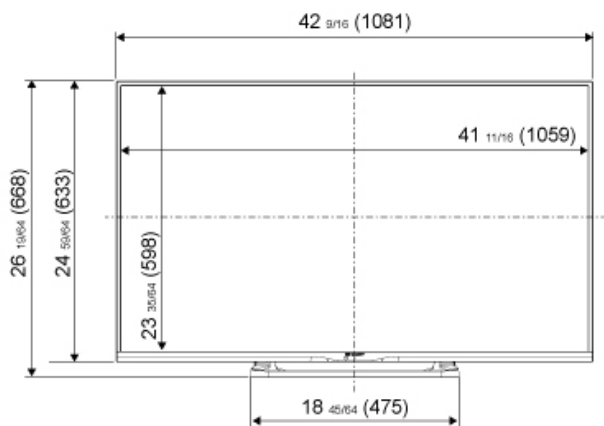

*1 Active area/Área activa/Zone active

*2 Thinnest part/Parte más delgada/Partie la plus mince

*3 Including projecting parts/Incluyendo partes salientes/Parties saillantes incluses



Dimensional Drawings



LC-43LE653U

Unit: inch (mm)
Unité: pouce (mm)
Unidad: pulgada (mm)

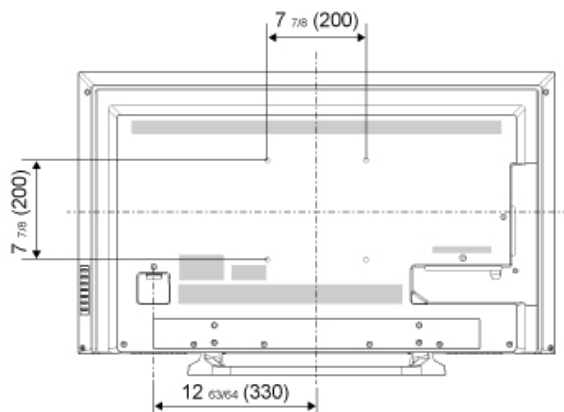
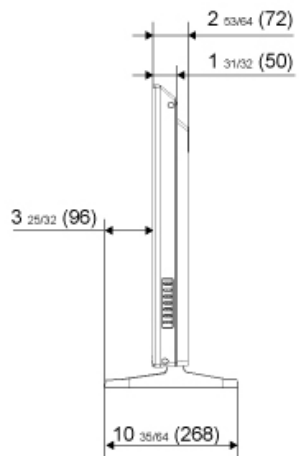
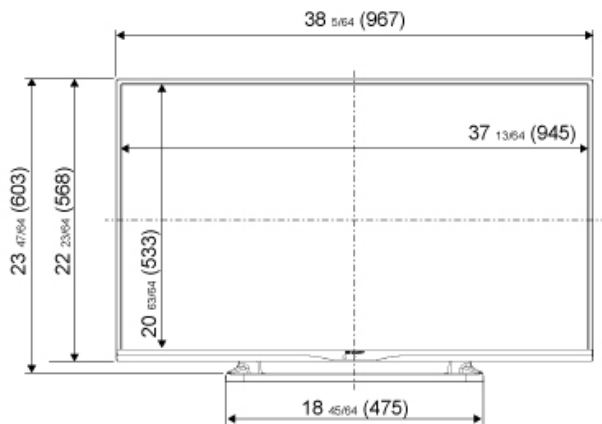

*1 Active area/Área activa/Zone active

*2 Thinnest part/Parte más delgada/Partie la plus mince

*3 Including projecting parts/Incluyendo partes salientes/Parties saillantes incluses



Software License



Information on the open-source software license.

Software composition

The software included in this product is comprised of various software components whose individual copyrights are held by third parties.

This product also makes use of freely distributed software and software components whose copyrights are held by third parties. These include software components covered by a GNU General Public License (hereafter GPL), a GNU Lesser General Public License (hereafter LGPL) or other license agreement.

Obtaining source code

Some of the open source software licensors require the distributor to provide the source code with the executable software components. GPL and LGPL include similar requirements. For information on obtaining the source code for the open source software and for obtaining the GPL, LGPL, and other license agreement information.

Acknowledgements

The following open source software components are included in this product:

Linux/kernel/U-Boot/busybox/uclibc zlib/libpng/libjpeg/DirectFB/TinyXML/Mp3Info/libotf/libfribidi Qt/libfreetype/libxml2/SQLite/ webkit/fontconfig/icu/OpenGL/cURL/c-ares/
Expat/libwebp/libmng/libunp/mongoose/

Software copyrights

Libfribidi
LGPL V2.1
Libotf
LGPL V2.1

Expat

Copyright (c) 1998, 1999, 2000 Thai Open Source Software Center Ltd and Clark Cooper
Copyright (c) 2001, 2002, 2003, 2004, 2005, 2006 Expat maintainers.

Permission is hereby granted, free of charge, to any person obtaining a copy of this software and associated documentation files (the "Software"), to deal in the Software without restriction, including without limitation the rights to use, copy, modify, merge, publish, distribute, sublicense, and/or sell copies of the Software, and to permit persons to whom the Software is furnished to do so, subject to the following conditions:

The above copyright notice and this permission notice shall be included in all copies or substantial portions of the Software.

THE SOFTWARE IS PROVIDED "AS IS", WITHOUT WARRANTY OF ANY KIND, EXPRESS OR IMPLIED, INCLUDING BUT NOT LIMITED TO THE WARRANTIES OF MERCHANTABILITY, FITNESS FOR A PARTICULAR PURPOSE AND NONINFRINGEMENT. IN NO EVENT SHALL THE AUTHORS OR COPYRIGHT HOLDERS BE LIABLE FOR ANY CLAIM, DAMAGES OR OTHER LIABILITY, WHETHER IN AN ACTION OF CONTRACT, TORT OR OTHERWISE, ARISING FROM, OUT OF OR IN CONNECTION WITH THE SOFTWARE OR THE USE OR OTHER DEALINGS IN THE SOFTWARE.

Libwebp

Copyright (c) 2010, Google Inc. All rights reserved.

Redistribution and use in source and binary forms, with or without modification, are permitted provided that the following conditions are met:

* Redistributions of source code must retain the above copyright notice, this list of conditions and the following disclaimer.

* Redistributions in binary form must reproduce the above copyright notice, this list of conditions and the following disclaimer in the documentation and/or other materials provided with the distribution.

* Neither the name of Google nor the names of its contributors may be used to endorse or promote products derived from this software without specific prior written permission.

THIS SOFTWARE IS PROVIDED BY THE COPYRIGHT HOLDERS AND CONTRIBUTORS "AS IS" AND ANY EXPRESS OR IMPLIED WARRANTIES, INCLUDING, BUT NOT LIMITED TO, THE IMPLIED WARRANTIES OF MERCHANTABILITY AND FITNESS FOR A PARTICULAR PURPOSE ARE DISCLAIMED. IN NO EVENT SHALL THE COPYRIGHT HOLDER OR CONTRIBUTORS BE LIABLE FOR ANY DIRECT, INDIRECT, INCIDENTAL, SPECIAL, EXEMPLARY, OR CONSEQUENTIAL DAMAGES (INCLUDING, BUT NOT LIMITED TO, PROCUREMENT OF SUBSTITUTE GOODS OR SERVICES; LOSS OF USE, DATA, OR PROFITS; OR BUSINESS INTERRUPTION) HOWEVER CAUSED AND ON ANY THEORY OF LIABILITY, WHETHER IN CONTRACT, STRICT LIABILITY, OR TORT (INCLUDING NEGLIGENCE OR OTHERWISE) ARISING IN ANY WAY OUT OF THE USE OF THIS SOFTWARE, EVEN IF ADVISED OF THE POSSIBILITY OF SUCH DAMAGE.



Software License(Continue)

Libmng

COPYRIGHT NOTICE:

Copyright (c) 2000-2007 Gerard Juyn (gerard@libmng.com)
[You may insert additional notices after this sentence if you modify this source]

For the purposes of this copyright and license, "Contributing Authors" is defined as the following set of individuals:

Gerard Juyn
Glenn Randers-Pehrson

The MNG Library is supplied "AS IS". The Contributing Authors disclaim all warranties, expressed or implied, including, without limitation, the warranties of merchantability and of fitness for any purpose. The Contributing Authors assume no liability for direct, indirect, incidental, special, exemplary, or consequential damages, which may result from the use of the MNG Library, even if advised of the possibility of such damage.

Permission is hereby granted to use, copy, modify, and distribute this source code, or portions hereof, for any purpose, without fee, subject to the following restrictions:

1. The origin of this source code must not be misrepresented; you must not claim that you wrote the original software.
2. Altered versions must be plainly marked as such and must not be misrepresented as being the original source.
3. This Copyright notice may not be removed or altered from any source or altered source distribution.

The Contributing Authors specifically permit, without fee, and encourage the use of this source code as a component to supporting the MNG and JNG file format in commercial products. If you use this source code in a product, acknowledgment would be highly appreciated.

Parts of this software have been adapted from the libpng package. Although this library supports all features from the PNG specification (as MNG descends from it) it does not require the libpng package. It does require the zlib library and optionally the IJG jpeg library, and/or the "little-cms"

This library's function is primarily to read and display MNG animations. It is not meant as a full-featured image-editing component! It does however offer creation and editing functionality at the chunk level. (future modifications may include some more support for creation and or editing)

Libupnp
Copyright (c) 2000-2003 Intel Corporation
All rights reserved.

Redistribution and use in source and binary forms, with or without modification, are permitted provided that the following conditions are met:

- * Redistributions of source code must retain the above copyright notice, this list of conditions and the following disclaimer.
- * Redistributions in binary form must reproduce the above copyright notice, this list of conditions and the following disclaimer in the documentation and/or other materials provided with the distribution.
- * Neither name of Intel Corporation nor the names of its contributors may be used to endorse or promote products derived from this software without specific prior written permission.

THIS SOFTWARE IS PROVIDED BY THE COPYRIGHT HOLDERS AND CONTRIBUTORS "AS IS" AND ANY EXPRESS OR IMPLIED WARRANTIES, INCLUDING, BUT NOT LIMITED TO, THE IMPLIED WARRANTIES OF MERCHANTABILITY AND FITNESS FOR A PARTICULAR PURPOSE ARE DISCLAIMED. IN NO EVENT SHALL INTEL OR CONTRIBUTORS BE LIABLE FOR ANY DIRECT, INDIRECT, INCIDENTAL, SPECIAL, EXEMPLARY, OR CONSEQUENTIAL DAMAGES (INCLUDING, BUT NOT LIMITED TO, PROCUREMENT OF SUBSTITUTE GOODS OR SERVICES; LOSS OF USE, DATA, OR PROFITS; OR BUSINESS INTERRUPTION) HOWEVER CAUSED AND ON ANY THEORY OF LIABILITY, WHETHER IN CONTRACT, STRICT LIABILITY, OR TORT (INCLUDING NEGLIGENCE OR OTHERWISE) ARISING IN ANY WAY OUT OF THE USE OF THIS SOFTWARE, EVEN IF ADVISED OF THE POSSIBILITY OF SUCH DAMAGE.

libjpeg
This software is copyright (c) 1991-2012, Thomas G. Lane, Guido Vollbeding. Portions of this software are based in part on the work of the Independent JPEG Group.

libpng
This software is Copyright (c) 2004, 2006-2007 Glenn Randers-Pehrson, and are distributed according to the same disclaimer and license as libpng-1.2.5 with the following individual added to the list of Contributing Authors Cosmin Truta



Software License(Continue)



mongoose

Copyright (c) 2004-2010 Sergey Lyubka

Permission is hereby granted, free of charge, to any person obtaining a copy of this software and associated documentation files (the "Software"), to deal in the Software without restriction, including without limitation the rights to use, copy, modify, merge, publish, distribute, sublicense, and/or sell copies of the Software, and to permit persons to whom the Software is furnished to do so, subject to the following conditions: The above copyright notice and this permission notice shall be included in all copies or substantial portions of the Software.

Qt

The Qt GUI Toolkit is Copyright (c) 2010 Nokia Corporation and/or its subsidiary(-ies).

Contact: Nokia Corporation (qt-info@nokia.com)

WebKit

Copyright (C) 2005, 2006, 2007, 2008, 2009 Apple Inc. All rights reserved.

Redistribution and use in source and binary forms, with or without modification, are permitted provided that the following conditions are met:

1. Redistributions of source code must retain the above copyright notice, this list of conditions and the following disclaimer.
2. Redistributions in binary form must reproduce the above copyright notice, this list of conditions and the following disclaimer in the documentation and/or other materials provided with the distribution.

libfreetype

Copyright (c) 2006, 2007, 2008, 2009, 2010 by David Turner, Robert Wilhelm, and Werner Lemberg.

The software is based in part of the work of the Free Type Team.

libxml2

Copyright (c) 1998-2003 Daniel Veillard. All Rights Reserved.

curl

COPYRIGHT AND PERMISSION NOTICE

Copyright (c) 1996 - 2009, Daniel Stenberg, <daniel@haxx.se>. All rights reserved.

Permission to use, copy, modify, and distribute this software for any purpose with or without fee is hereby granted, provided that the above copyright notice and this permission notice appear in all copies. THE SOFTWARE IS PROVIDED "AS IS", WITHOUT WARRANTY OF ANY KIND, EXPRESS OR IMPLIED, INCLUDING BUT NOT LIMITED TO THE WARRANTIES OF MERCHANTABILITY, FITNESS FOR A PARTICULAR PURPOSE AND NONINFRINGEMENT OF THIRD PARTY RIGHTS. IN NO EVENT SHALL THE AUTHORS OR COPYRIGHT HOLDERS BE LIABLE FOR ANY CLAIM, DAMAGES OR OTHER LIABILITY, WHETHER IN AN ACTION OF CONTRACT, TORT OR OTHERWISE, ARISING FROM, OUT OF OR IN CONNECTION WITH THE SOFTWARE OR THE USE OR OTHER DEALINGS IN THE SOFTWARE. Except as contained in this notice, the name of a copyright holder shall not be used in advertising or otherwise to promote the sale, use or other dealings in this Software without prior written authorization of the copyright holder.

OpenSSL

LICENSE ISSUES

The OpenSSL toolkit stays under a dual license, i.e. both the conditions of the OpenSSL License and the original SSLeay license apply to the toolkit. See below for the actual license texts. Actually both licenses are BSD-style Open Source licenses. In case of any license issues related to OpenSSL please contact openssl-core@openssl.org.

OpenSSL License

Copyright (c) 1998-2008 The OpenSSL Project. All rights reserved.

Redistribution and use in source and binary forms, with or without modification, are permitted provided that the following conditions are met:

1. Redistributions of source code must retain the above copyright notice, this list of conditions and the following disclaimer.
2. Redistributions in binary form must reproduce the above copyright notice, this list of conditions and the following disclaimer in the documentation and/or other materials provided with the distribution.
3. All advertising materials mentioning features or use of this software must display the following acknowledgment: "This product includes software developed by the OpenSSL Project for use in the OpenSSL Toolkit. (<http://www.openssl.org/>)"
4. The names "OpenSSL Toolkit" and "OpenSSL Project" must not be used to endorse or promote products derived from this software without prior written permission. For written permission, please contact openssl-core@openssl.org.



Software License(Continue)



5. Products derived from this software may not be called "OpenSSL" nor may "OpenSSL" appear in their names without prior written permission of the OpenSSL Project.

6. Redistributions of any form whatsoever must retain the following acknowledgment:
"This product includes software developed by the OpenSSL Project for use in the OpenSSL Toolkit (<http://www.openssl.org/>)"

THIS SOFTWARE IS PROVIDED BY THE OpenSSL PROJECT "AS IS" AND ANY EXPRESSED OR IMPLIED WARRANTIES, INCLUDING, BUT NOT LIMITED TO, THE IMPLIED WARRANTIES OF MERCHANTABILITY AND FITNESS FOR A PARTICULAR PURPOSE ARE DISCLAIMED. IN NO EVENT SHALL THE OpenSSL PROJECT OR ITS CONTRIBUTORS BE LIABLE FOR ANY DIRECT, INDIRECT, INCIDENTAL, SPECIAL, EXEMPLARY, OR CONSEQUENTIAL DAMAGES (INCLUDING, BUT NOT LIMITED TO, PROCUREMENT OF SUBSTITUTE GOODS OR SERVICES; LOSS OF USE, DATA, OR PROFITS; OR BUSINESS INTERRUPTION) HOWEVER CAUSED AND ON ANY THEORY OF LIABILITY, WHETHER IN CONTRACT, STRICT LIABILITY, OR TORT (INCLUDING NEGLIGENCE OR OTHERWISE) ARISING IN ANY WAY OUT OF THE USE OF THIS SOFTWARE, EVEN IF ADVISED OF THE POSSIBILITY OF SUCH DAMAGE.

This product includes cryptographic software written by Eric Young (ey@cryptsoft.com). This product includes software written by Tim Hudson (tjh@cryptsoft.com).

Original SSLey License
Copyright (C) 1995-1998 Eric Young (ey@cryptsoft.com)
All rights reserved.
This package is an SSL implementation written by Eric Young (ey@cryptsoft.com).
The implementation was written so as to conform with Netscapes SSL.

This library is free for commercial and non-commercial use as long as the following conditions are aheared to. The following conditions apply to all code found in this distribution, be it the RC4, RSA, lhash, DES, etc., code; not just the SSL code. The SSL documentation included with this distribution is covered by the same copyright terms except that the holder is Tim Hudson (tjh@cryptsoft.com).

Copyright remains Eric Young's, and as such any Copyright notices in the code are not to be removed. If this package is used in a product, Eric Young should be given attribution as the author of the parts of the library used. This can be in the form of a textual message at program startup or in documentation (online or textual) provided with the package.

Redistribution and use in source and binary forms, with or without modification, are permitted provided that the following conditions are met:

1. Redistributions of source code must retain the copyright notice, this list of conditions and the following disclaimer.
2. Redistributions in binary form must reproduce the above copyright notice, this list of conditions and the following disclaimer in the documentation and/or other materials provided with the distribution.
3. All advertising materials mentioning features or use of this software must display the following acknowledgement:
"This product includes cryptographic software written by Eric Young (ey@cryptsoft.com)"
The word 'cryptographic' can be left out if the rouines from the library being used are not cryptographic related :-).
4. If you include any Windows specific code (or a derivative thereof) from the apps directory (application code) you must include an acknowledgement:
"This product includes software written by Tim Hudson (tjh@cryptsoft.com)"

THIS SOFTWARE IS PROVIDED BY ERIC YOUNG "AS IS" AND ANY EXPRESS OR IMPLIED WARRANTIES, INCLUDING, BUT NOT LIMITED TO, THE IMPLIED WARRANTIES OF MERCHANTABILITY AND FITNESS FOR A PARTICULAR PURPOSE ARE DISCLAIMED. IN NO EVENT SHALL THE AUTHOR OR CONTRIBUTORS BE LIABLE FOR ANY DIRECT, INDIRECT, INCIDENTAL, SPECIAL, EXEMPLARY, OR CONSEQUENTIAL DAMAGES (INCLUDING, BUT NOT LIMITED TO, PROCUREMENT OF SUBSTITUTE GOODS OR SERVICES; LOSS OF USE, DATA, OR PROFITS; OR BUSINESS INTERRUPTION) HOWEVER CAUSED AND ON ANY THEORY OF LIABILITY, WHETHER IN CONTRACT, STRICT LIABILITY, OR TORT (INCLUDING NEGLIGENCE OR OTHERWISE) ARISING IN ANY WAY OUT OF THE USE OF THIS SOFTWARE, EVEN IF ADVISED OF THE POSSIBILITY OF SUCH DAMAGE.

The licence and distribution terms for any publically available version or derivative of this code cannot be changed. i.e. this code cannot simply be copied and put under another distribution licence [including the GNU Public Licence.]

SQLite

All of the code and documentation in SQLite has been dedicated to the public domain by the authors. All code authors, and representatives of the companies they work for, have signed affidavits dedicating their contributions to the public domain and originals of those signed affidavits are stored in a firesafe at the main offices of Hwaci. Anyone is free to copy, modify, publish, use, compile, sell, or distribute the original SQLite code, either in source code form or as a compiled binary, for any purpose, commercial or non-commercial, and by any means.



Software License(Continue)



The previous paragraph applies to the deliverable code and documentation in SQLite - those parts of the SQLite library that you actually bundle and ship with a larger application. Some scripts used as part of the build process (for example the "configure" scripts generated by autoconf) might fall under other open-source licenses. Nothing from these build scripts ever reaches the final deliverable SQLite library, however, and so the licenses associated with those scripts should not be a factor in assessing your rights to copy and use the SQLite library.

All of the deliverable code in SQLite has been written from scratch. No code has been taken from other projects or from the open internet. Every line of code can be traced back to its original author, and all of those authors have public domain dedications on file. So the SQLite code base is clean and is uncontaminated with licensed code from other projects.

TinyXML

Portions copyright (c) 1995-1996 Jean-loup Gailly and Mark Adler.

Mp3Info

Copyright (c) 2006-2008 Dan Sully & Logitech. All rights reserved.

Copyright (c) 1998-2005 Chris Nandor. All rights reserved.

This program is free software; you can redistribute it and/or modify it under the same terms as Perl itself.

zlib

Portions copyright (c) 1995-1996 Jean-loup Gailly and Mark Adler.

Apache License

Version 2.0, January 2004

<http://www.apache.org/licenses/>

TERMS AND CONDITIONS FOR USE, REPRODUCTION, AND DISTRIBUTION

1. Definitions. "License" shall mean the terms and conditions for use, reproduction, and distribution as defined by Sections 1 through 9 of this document.

"Licensor" shall mean the copyright owner or entity authorized by the copyright owner that is granting the License.

"Legal Entity" shall mean the union of the acting entity and all other entities that control, are controlled by, or are under common control with that entity. For the purposes of this definition, "control" means (i) the power, direct or indirect, to cause the direction or management of such entity, whether by contract or otherwise, or (ii) ownership of fifty percent (50%) or more of the outstanding shares, or (iii) beneficial ownership of such entity.

"You" (or "Your") shall mean an individual or Legal Entity exercising permissions granted by this License.

"Source" form shall mean the preferred form for making modifications, including but not limited to software source code, documentation source, and configuration files.

"Object" form shall mean any form resulting from mechanical transformation or translation of a Source form, including but not limited to compiled object code, generated documentation, and conversions to other media types.

"Work" shall mean the work of authorship, whether in Source or Object form, made available under the License, as indicated by a copyright notice that is included in or attached to the work (an example is provided in the Appendix below).

"Derivative Works" shall mean any work, whether in Source or Object form, that is based on (or derived from) the Work and for which the editorial revisions, annotations, elaborations, or other modifications represent, as a whole, an original work of authorship. For the purposes of this License, Derivative Works shall not include works that remain separable from, or merely link (or bind by name) to the interfaces of, the Work and Derivative Works thereof.

"Contribution" shall mean any work of authorship, including the original version of the Work and any modifications or additions to that Work or Derivative Works thereof, that is intentionally submitted to Licensor for inclusion in the Work by the copyright owner or by an individual or Legal Entity authorized to submit on behalf of the copyright owner. For the purposes of this definition, "submitted" means any form of electronic, verbal, or written communication sent to the Licensor or its representatives, including but not limited to communication on electronic mailing lists, source code control systems, and issue tracking systems that are managed by, or on behalf of, the Licensor for the purpose of discussing and improving the Work, but excluding communication that is conspicuously marked or otherwise designated in writing by the copyright owner as "Not a Contribution."

"Contributor" shall mean Licensor and any individual or Legal Entity on behalf of whom a Contribution has been received by Licensor and subsequently incorporated within the Work.

2. Grant of Copyright License. Subject to the terms and conditions of this License, each Contributor hereby grants to You a perpetual, worldwide, non-exclusive, no-charge, royalty-free, irrevocable copyright license to reproduce, prepare Derivative Works of, publicly display, publicly perform, sublicense, and distribute the Work and such Derivative Works in Source or Object form.



Software License(Continue)



3. Grant of Patent License. Subject to the terms and conditions of this License, each Contributor hereby grants to You a perpetual, worldwide, non-exclusive, no-charge, royalty-free, irrevocable (except as stated in this section) patent license to make, have made, use, offer to sell, sell, import, and otherwise transfer the Work, where such license applies only to those patent claims licensable by such Contributor that are necessarily infringed by their Contribution(s) alone or by combination of their Contribution(s) with the Work to which such Contribution(s) was submitted. If You institute patent litigation against any entity (including a cross-claim or counterclaim in a lawsuit) alleging that the Work or a Contribution incorporated within the Work constitutes direct or contributory patent infringement, then any patent licenses granted to You under this License for that Work shall terminate as of the date such litigation is filed.

4. Redistribution. You may reproduce and distribute copies of the Work or Derivative Works thereof in any medium, with or without modifications, and in Source or Object form, provided that You meet the following conditions:

You must give any other recipients of the Work or Derivative Works a copy of this License; and

You must cause any modified files to carry prominent notices stating that You changed the files; and

You must retain, in the Source form of any Derivative Works that You distribute, all copyright, patent, trademark, and attribution notices from the Source form of the Work, excluding those notices that do not pertain to any part of the Derivative Works; and

If the Work includes a "NOTICE" text file as part of its distribution, then any Derivative Works that You distribute must include a readable copy of the attribution notices contained within such NOTICE file, excluding those notices that do not pertain to any part of the Derivative Works, in at least one of the following places: within a NOTICE text file distributed as part of the Derivative Works; within the Source form or documentation, if provided along with the Derivative Works; or, within a display generated by the Derivative Works, if and wherever such third-party notices normally appear. The contents of the NOTICE file are for informational purposes only and do not modify the License. You may add Your own attribution notices within Derivative Works that You distribute, alongside or as an addendum to the NOTICE text from the Work, provided that such additional attribution notices cannot be construed as modifying the License. You may add Your own copyright statement to Your modifications and may provide additional or different license terms and conditions for use, reproduction, or distribution of Your modifications, or for any such Derivative Works as a whole, provided Your use, reproduction, and distribution of the Work otherwise complies with the conditions stated in this License.

5. Submission of Contributions. Unless You explicitly state otherwise, any Contribution intentionally submitted for inclusion in the Work by You to the Licensor shall be under the terms and conditions of this License, without any additional terms or conditions. Notwithstanding the above, nothing herein shall supersede or modify the terms of any separate license agreement you may have executed with Licensor regarding such Contributions.

6. Trademarks. This License does not grant permission to use the trade names, trademarks, service marks, or product names of the Licensor, except as required for reasonable and customary use in describing the origin of the Work and reproducing the content of the NOTICE file.

7. Disclaimer of Warranty. Unless required by applicable law or agreed to in writing, Licensor provides the Work (and each Contributor provides its Contributions) on an "AS IS" BASIS, WITHOUT WARRANTIES OR CONDITIONS OF ANY KIND, either express or implied, including, without limitation, any warranties or conditions of TITLE, NON-INFRINGEMENT, MERCHANTABILITY, or FITNESS FOR A PARTICULAR PURPOSE. You are solely responsible for determining the appropriateness of using or redistributing the Work and assume any risks associated with Your exercise of permissions under this License.

8. Limitation of Liability. In no event and under no legal theory, whether in tort (including negligence), contract, or otherwise, unless required by applicable law (such as deliberate and grossly negligent acts) or agreed to in writing, shall any Contributor be liable to You for damages, including any direct, indirect, special, incidental, or consequential damages of any character arising as a result of this License or out of the use or inability to use the Work (including but not limited to damages for loss of goodwill, work stoppage, computer failure or malfunction, or any and all other commercial damages or losses), even if such Contributor has been advised of the possibility of such damages.

9. Accepting Warranty or Additional Liability. While redistributing the Work or Derivative Works thereof, You may choose to offer, and charge a fee for, acceptance of support, warranty, indemnity, or other liability obligations and/or rights consistent with this License. However, in accepting such obligations, You may act only on Your own behalf and on Your sole responsibility, not on behalf of any other Contributor, and only if You agree to indemnify, defend, and hold each Contributor harmless for any liability incurred by, or claims asserted against, such Contributor by reason of your accepting any such warranty or additional liability.

END OF TERMS AND CONDITIONS



Software License(Continue)



APPENDIX: How to apply the Apache License to your work To apply the Apache License to your work, attach the following boilerplate notice, with the fields enclosed by brackets "[]" replaced with your own identifying information. (Don't include the brackets!) The text should be enclosed in the appropriate comment syntax for the file format. We also recommend that a file or class name and description of purpose be included on the same "printed page" as the copyright notice for easier identification within third-party archives.

Copyright [yyyy] [name of copyright owner]

Licensed under the Apache License, Version 2.0 (the "License"); you may not use this file except in compliance with the License. You may obtain a copy of the License at

<http://www.apache.org/licenses/LICENSE-2.0>

Unless required by applicable law or agreed to in writing, software distributed under the License is distributed on an "AS IS" BASIS, WITHOUT WARRANTIES OR CONDITIONS OF ANY KIND, either express or implied. See the License for the specific language governing permissions and limitations under the License.

Fonts are (c) Bitstream (see below). DejaVu changes are in public domain. Glyphs imported from Arev fonts are (c) Tavmjong Bah (see below)

Bitstream Vera Fonts Copyright

Copyright (c) 2003 by Bitstream, Inc. All Rights Reserved. Bitstream Vera is a trademark of Bitstream, Inc. Permission is hereby granted, free of charge, to any person obtaining a copy of the fonts accompanying this license ("Fonts") and associated documentation files (the "Font Software"), to reproduce and distribute the Font Software, including without limitation the rights to use, copy, merge, publish, distribute, and/or sell copies of the Font Software, and to permit persons to whom the Font Software is furnished to do so, subject to the following conditions:

The above copyright and trademark notices and this permission notice shall be included in all copies of one or more of the Font Software typefaces.

The Font Software may be modified, altered, or added to, and in particular the designs of glyphs or characters in the Fonts may be modified and additional glyphs or characters may be added to the Fonts, only if the fonts are renamed to names not containing either the words "Bitstream" or the word "Vera".

This License becomes null and void to the extent applicable to Fonts or Font Software that has been modified and is distributed under the "Bitstream Vera" names.

The Font Software may be sold as part of a larger software package but no copy of one or more of the Font Software typefaces may be sold by itself.

THE FONT SOFTWARE IS PROVIDED "AS IS", WITHOUT WARRANTY OF ANY KIND, EXPRESS OR IMPLIED, INCLUDING BUT NOT LIMITED TO ANY WARRANTIES OF MERCHANTABILITY, FITNESS FOR A PARTICULAR PURPOSE AND NONINFRINGEMENT OF COPYRIGHT, PATENT, TRADEMARK, OR OTHER RIGHT. IN NO EVENT SHALL BITSTREAM OR THE GNOME FOUNDATION BE LIABLE FOR ANY CLAIM, DAMAGES OR OTHER LIABILITY, INCLUDING ANY GENERAL, SPECIAL, INDIRECT, INCIDENTAL, OR CONSEQUENTIAL DAMAGES, WHETHER IN AN ACTION OF CONTRACT, TORT OR OTHERWISE, ARISING FROM, OUT OF THE USE OR INABILITY TO USE THE FONT SOFTWARE OR FROM OTHER DEALINGS IN THE FONT SOFTWARE.

Except as contained in this notice, the names of Gnome, the Gnome Foundation, and Bitstream Inc., shall not be used in advertising or otherwise to promote the sale, use or other dealings in this Font Software without prior written authorization from the Gnome Foundation or Bitstream Inc., respectively. For further information, contact: fonts at gnome dot org.

Arev Fonts Copyright

Copyright (c) 2006 by Tavmjong Bah. All Rights Reserved.

Permission is hereby granted, free of charge, to any person obtaining a copy of the fonts accompanying this license ("Fonts") and associated documentation files (the "Font Software"), to reproduce and distribute the modifications to the Bitstream Vera Font Software, including without limitation the rights to use, copy, merge, publish, distribute, and/or sell copies of the Font Software, and to permit persons to whom the Font Software is furnished to do so, subject to the following conditions:

The above copyright and trademark notices and this permission notice shall be included in all copies of one or more of the Font Software typefaces.

The Font Software may be modified, altered, or added to, and in particular the designs of glyphs or characters in the Fonts may be modified and additional glyphs or characters may be added to the Fonts, only if the fonts are renamed to names not containing either the words "Tavmjong Bah" or the word "Arev".



Software License(Continue)



This License becomes null and void to the extent applicable to Fonts or Font Software that has been modified and is distributed under the "Tavmjong Bah Arev" names.

The Font Software may be sold as part of a larger software package but no copy of one or more of the Font Software typefaces may be sold by itself.

THE FONT SOFTWARE IS PROVIDED "AS IS", WITHOUT WARRANTY OF ANY KIND, EXPRESS OR IMPLIED, INCLUDING BUT NOT LIMITED TO ANY WARRANTIES OF MERCHANTABILITY, FITNESS FOR A PARTICULAR PURPOSE AND NON-INFRINGEMENT OF COPYRIGHT, PATENT, TRADEMARK, OR OTHER RIGHT. IN NO EVENT SHALL TAVMJONG BAH BE LIABLE FOR ANY CLAIM, DAMAGES OR OTHER LIABILITY, INCLUDING ANY GENERAL, SPECIAL, INDIRECT, INCIDENTAL, OR CONSEQUENTIAL DAMAGES, WHETHER IN AN ACTION OF CONTRACT, TORT OR OTHERWISE, ARISING FROM, OUT OF THE USE OR INABILITY TO USE THE FONT SOFTWARE OR FROM OTHER DEALINGS IN THE FONT SOFTWARE.

Except as contained in this notice, the name of Tavmjong Bah shall not be used in advertising or otherwise to promote the sale, use or other dealings in this Font Software without prior written authorization from Tavmjong Bah. For further information, contact: tavmjong @ free. fr.

GNU LESSER GENERAL PUBLIC LICENSE

Version 3, 29 June 2007

Copyright © 2007 Free Software Foundation, Inc. <<http://fsf.org/>> Everyone is permitted to copy and distribute verbatim copies of this license document, but changing it is not allowed. This version of the GNU Lesser General Public License incorporates the terms and conditions of version 3 of the GNU General Public License, supplemented by the additional permissions listed below.

0. Additional Definitions.

As used herein, "this License" refers to version 3 of the GNU Lesser General Public License, and the "GNU GPL" refers to version 3 of the GNU General Public License.

"The Library" refers to a covered work governed by this License, other than an Application or a Combined Work as defined below.

An "Application" is any work that makes use of an interface provided by the Library, but which is not otherwise based on the Library. Defining a subclass of a class defined by the Library is deemed a mode of using an interface provided by the Library.

A "Combined Work" is a work produced by combining or linking an Application with the Library. The particular version of the Library with which the Combined Work was made is also called the "Linked Version".

The "Minimal Corresponding Source" for a Combined Work means the Corresponding Source for the Combined Work, excluding any source code for portions of the Combined Work that, considered in isolation, are based on the Application, and not on the Linked Version.

The "Corresponding Application Code" for a Combined Work means the object code and/or source code for the Application, including any data and utility programs needed for reproducing the Combined Work from the Application, but excluding the System Libraries of the Combined Work.

1. Exception to Section 3 of the GNU GPL.

You may convey a covered work under sections 3 and 4 of this License without being bound by section 3 of the GNU GPL.

2. Conveying Modified Versions.

If you modify a copy of the Library, and, in your modifications, a facility refers to a function or data to be supplied by an Application that uses the facility (other than as an argument passed when the facility is invoked), then you may convey a copy of the modified version:

- a) under this License, provided that you make a good faith effort to ensure that, in the event an Application does not supply the function or data, the facility still operates, and performs whatever part of its purpose remains meaningful, or
- b) under the GNU GPL, with none of the additional permissions of this License applicable to that copy.

3. Object Code Incorporating Material from Library Header Files.

The object code form of an Application may incorporate material from a header file that is part of the Library. You may convey such object code under terms of your choice, provided that, if the incorporated material is not limited to numerical parameters, data structure layouts and accessors, or small macros, inline functions and templates (ten or fewer lines in length), you do both of the following:

- a) Give prominent notice with each copy of the object code that the Library is used in it and that the Library and its use are covered by this License.
- b) Accompany the object code with a copy of the GNU GPL and this license document.



Software License(Continue)



4. Combined Works.

You may convey a Combined Work under terms of your choice that, taken together, effectively do not restrict modification of the portions of the Library contained in the Combined Work and reverse engineering for debugging such modifications, if you also do each of the following:

- a) Give prominent notice with each copy of the Combined Work that the Library is used in it and that the Library and its use are covered by this License.
- b) Accompany the Combined Work with a copy of the GNU GPL and this license document.
- c) For a Combined Work that displays copyright notices during execution, include the copyright notice for the Library among these notices, as well as a reference directing the user to the copies of the GNU GPL and this license document.
- d) Do one of the following:
 - 0) Convey the Minimal Corresponding Source under the terms of this License, and the Corresponding Application Code in a form suitable for, and under terms that permit, the user to recombine or relink the Application with a modified version of the Linked Version to produce a modified Combined Work, in the manner specified by section 6 of the GNU GPL for conveying Corresponding Source.
 - 1) Use a suitable shared library mechanism for linking with the Library. A suitable mechanism is one that (a) uses at run time a copy of the Library already present on the user's computer system, and (b) will operate properly with a modified version of the Library that is interface-compatible with the Linked Version.
- e) Provide Installation Information, but only if you would otherwise be required to provide such information under section 6 of the GNU GPL, and only to the extent that such information is necessary to install and execute a modified version of the Combined Work produced by recombining or relinking the Application with a modified version of the Linked Version. (If you use option 4d0, the Installation Information must accompany the Minimal Corresponding Source and Corresponding Application Code. If you use option 4d1, you must provide the Installation Information in the manner specified by section 6 of the GNU GPL for conveying Corresponding Source.)

5. Combined Libraries.

You may place library facilities that are a work based on the Library side by side in a single library together with other library facilities that are not Applications and are not covered by this License, and convey such a combined library under terms of your choice, if you do both of the following:

- a) Accompany the combined library with a copy of the same work based on the Library, uncombined with any other library facilities, conveyed under the terms of this License.
- b) Give prominent notice with the combined library that part of it is a work based on the Library, and explaining where to find the accompanying uncombined form of the same work.

6. Revised Versions of the GNU Lesser General Public License.

The Free Software Foundation may publish revised and/or new versions of the GNU Lesser General Public License from time to time. Such new versions will be similar in spirit to the present version, but may differ in detail to address new problems or concerns.

Each version is given a distinguishing version number. If the Library as you received it specifies that a certain numbered version of the GNU Lesser General Public License "or any later version" applies to it, you have the option of following the terms and conditions either of that published version or of any later version published by the Free Software Foundation. If the Library as you received it does not specify a version number of the GNU Lesser General Public License, you may choose any version of the GNU Lesser General Public License ever published by the Free Software Foundation.

If the Library as you received it specifies that a proxy can decide whether future versions of the GNU Lesser General Public License shall apply, that proxy's public statement of acceptance of any version is permanent authorization for you to choose that version for the Library.



Software License(Continue)



GNU GENERAL PUBLIC LICENSE

Version 3, 29 June 2007

Copyright © 2007 Free Software Foundation, Inc. <<http://fsf.org/>> Everyone is permitted to copy and distribute verbatim copies of this license document, but changing it is not allowed.

Preamble

The GNU General Public License is a free, copyleft license for software and other kinds of works.

The licenses for most software and other practical works are designed to take away your freedom to share and change the works. By contrast, the GNU General Public License is intended to guarantee your freedom to share and change all versions of a program--to make sure it remains free software for all its users. We, the Free Software Foundation, use the GNU General Public License for most of our software; it applies also to any other work released this way by its authors. You can apply it to your programs, too.

When we speak of free software, we are referring to freedom, not price. Our General Public Licenses are designed to make sure that you have the freedom to distribute copies of free software (and charge for them if you wish), that you receive source code or can get it if you want it, that you can change the software or use pieces of it in new free programs, and that you know you can do these things.

To protect your rights, we need to prevent others from denying you these rights or asking you to surrender the rights. Therefore, you have certain responsibilities if you distribute copies of the software, or if you modify it: responsibilities to respect the freedom of others.

For example, if you distribute copies of such a program, whether gratis or for a fee, you must pass on to the recipients the same freedoms that you received. You must make sure that they, too, receive or can get the source code. And you must show them these terms so they know their rights.

Developers that use the GNU GPL protect your rights with two steps: (1) assert copyright on the software, and (2) offer you this License giving you legal permission to copy, distribute and/or modify it.

For the developers' and authors' protection, the GPL clearly explains that there is no warranty for this free software. For both users' and authors' sake, the GPL requires that modified versions be marked as changed, so that their problems will not be attributed erroneously to authors of previous versions.

Some devices are designed to deny users access to install or run modified versions of the software inside them, although the manufacturer can do so. This is fundamentally incompatible with the aim of protecting users' freedom to change the software. The systematic pattern of such abuse occurs in the area of products for individuals to use, which is precisely where it is most unacceptable. Therefore, we have designed this version of the GPL to prohibit the practice for those products. If such problems arise substantially in other domains, we stand ready to extend this provision to those domains in future versions of the GPL, as needed to protect the freedom of users.

Finally, every program is threatened constantly by software patents. States should not allow patents to restrict development and use of software on general-purpose computers, but in those that do, we wish to avoid the special danger that patents applied to a free program could make it effectively proprietary. To prevent this, the GPL assures that patents cannot be used to render the program non-free.

The precise terms and conditions for copying, distribution and modification follow.

TERMS AND CONDITIONS

0. Definitions.

"This License" refers to version 3 of the GNU General Public License.

"Copyright" also means copyright-like laws that apply to other kinds of works, such as semiconductor masks.

"Copyright" also means copyright-like laws that apply to other kinds of works, such as semiconductor masks.

To "modify" a work means to copy from or adapt all or part of the work in a fashion requiring copyright permission, other than the making of an exact copy. The resulting work is called a "modified version" of the earlier work or a work "based on" the earlier work.

A "covered work" means either the unmodified Program or a work based on the Program.

To "propagate" a work means to do anything with it that, without permission, would make you directly or secondarily liable for infringement under applicable copyright law, except executing it on a computer or modifying a private copy. Propagation includes copying, distribution (with or without modification), making available to the public, and in some countries other activities as well.

To "convey" a work means any kind of propagation that enables other parties to make or receive copies. Mere interaction with a user through a computer network, with no transfer of a copy, is not conveying.

An interactive user interface displays "Appropriate Legal Notices" to the extent that it includes a convenient and prominently visible feature that (1) displays an appropriate copyright notice, and (2) tells the user that there is no warranty for the work (except to the extent that warranties are provided), that licensees may convey the work under this License, and how to view a copy of this License. If the interface presents a list of user commands or options, such as a menu, a prominent item in the list meets this criterion.

1. Source Code.

The "source code" for a work means the preferred form of the work for making modifications to it. "Object code" means any non-source form of a work.

A "Standard Interface" means an interface that either is an official standard defined by a recognized standards body, or, in the case of interfaces specified for a particular programming language, one that is widely used among developers working in that language.

The "System Libraries" of an executable work include anything, other than the work as a whole, that (a) is included in the normal form of packaging a Major Component, but which is not part of that Major Component, and (b) serves only to enable use of the work with that Major Component, or to implement a Standard Interface for which an implementation is available to the public in source code form. A "Major Component", in this context, means a major essential component (kernel, window system, and so on) of the specific operating system (if any) on which the executable work runs, or a compiler used to produce the work, or an object code interpreter used to run it.

The "Corresponding Source" for a work in object code form means all the source code needed to generate, install, and (for an executable work) run the object code and to modify the work, including scripts to control those activities. However, it does not include the work's System Libraries, or general-purpose tools or generally available free programs which are used unmodified in performing those activities but which are not part of the work. For example, Corresponding Source includes interface definition files associated with source files for the work, and the source code for shared libraries and dynamically linked subprograms that the work is specifically designed to require, such as by intimate data communication or control flow between

The Corresponding Source need not include anything that users can regenerate automatically from other parts of the Corresponding Source.

The Corresponding Source for a work in source code form is that same work.

2. Basic Permissions.

All rights granted under this License are granted for the term of copyright on the Program, and are irrevocable provided the stated conditions are met. This License explicitly affirms your unlimited permission to run the unmodified Program. The output from running a covered work is covered by this License only if the output, given its content, constitutes a covered work. This License acknowledges your rights of fair use or other equivalent, as provided by copyright law.

You may make, run and propagate covered works that you do not convey, without conditions so long as your license otherwise remains in force. You may convey covered works to others for the sole purpose of having them make modifications exclusively for you, or provide you with facilities for running those works, provided that you comply with the terms of this License in conveying all material for which you do not control copyright. Those thus making or running the covered works for you must do so exclusively on your behalf, under your direction and control, on terms that prohibit them from making any copies of your copyrighted material outside their relationship with you.

Conveying under any other circumstances is permitted solely under the conditions stated below. Sublicensing is not allowed; section 10 makes it unnecessary.

3. Protecting Users' Legal Rights From Anti-Circumvention Law.

No covered work shall be deemed part of an effective technological measure under any applicable law fulfilling obligations under article 11 of the WIPO copyright treaty adopted on 20 December 1996, or similar laws prohibiting or restricting circumvention of such measures.

When you convey a covered work, you waive any legal power to forbid circumvention of technological measures to the extent such circumvention is effected by exercising rights under this License with respect to the covered work, and you disclaim any intention to limit operation or modification of the work as a means of enforcing, against the work's users, your or third parties' legal rights to forbid circumvention of technological measures.



Software License(Continue)



4. Conveying Verbatim Copies.

You may convey verbatim copies of the Program's source code as you receive it, in any medium, provided that you conspicuously and appropriately publish on each copy an appropriate copyright notice; keep intact all notices stating that this License and any non-permissive terms added in accord with section 7 apply to the code; keep intact all notices of the absence of any warranty; and give all recipients a copy of this License along with the Program.

You may charge any price or no price for each copy that you convey, and you may offer support or warranty protection for a fee.

5. Conveying Modified Source Versions.

You may convey a work based on the Program, or the modifications to produce it from the Program, in the form of source code under the terms of section 4, provided that you also meet all of these conditions:

- a) The work must carry prominent notices stating that you modified it, and giving a relevant date.
- b) The work must carry prominent notices stating that it is released under this License and any conditions added under section 7. This requirement modifies the requirement in section 4 to "keep intact all notices".
- c) You must license the entire work, as a whole, under this License to anyone who comes into possession of a copy. This License will therefore apply, along with any applicable section 7 additional terms, to the whole of the work, and all its parts, regardless of how they are packaged. This License gives no permission to license the work in any other way, but it does not invalidate such permission if you have separately received it.
- d) If the work has interactive user interfaces, each must display Appropriate Legal Notices; however, if the Program has interactive interfaces that do not display Appropriate Legal Notices, your work need not make them do so.

A compilation of a covered work with other separate and independent works, which are not by their nature extensions of the covered work, and which are not combined with it such as to form a larger program, in or on a volume of a storage or distribution medium, is called an "aggregate" if the compilation and its resulting copyright are not used to limit the access or legal rights of the compilation's users beyond what the individual works permit. Inclusion of a covered work in an aggregate does not cause this License to apply to the other parts of the aggregate.

6. Conveying Non-Source Forms.

You may convey a covered work in object code form under the terms of sections 4 and 5, provided that you also convey the machine-readable Corresponding Source under the terms of this License, in one of these ways:

- a) Convey the object code in, or embodied in, a physical product (including a physical distribution medium), accompanied by the Corresponding Source fixed on a durable physical medium customarily used for software interchange.
- b) Convey the object code in, or embodied in, a physical product (including a physical distribution medium), accompanied by a written offer, valid for at least three years and valid for as long as you offer spare parts or customer support for that product model, to give anyone who possesses the object code either (1) a copy of the Corresponding Source for all the software in the product that is covered by this License, on a durable physical medium customarily used for software interchange, for a price no more than your reasonable cost of physically performing this conveying of source, or (2) access to copy the Corresponding Source from a network server at no charge.
- c) Convey individual copies of the object code with a copy of the written offer to provide the Corresponding Source. This alternative is allowed only occasionally and noncommercially, and only if you received the object code with such an offer, in accord with subsection 6b.
- d) Convey the object code by offering access from a designated place (gratis or for a charge), and offer equivalent access to the Corresponding Source in the same way through the same place at no further charge. You need not require recipients to copy the Corresponding Source along with the object code. If the place to copy the object code is a network server, the Corresponding Source may be on a different server (operated by you or a third party) that supports equivalent copying facilities, provided you maintain clear directions next to the object code saying where to find the Corresponding Source. Regardless of what server hosts the Corresponding Source, you remain obligated to ensure that it is available for as long as needed to satisfy these requirements.
- e) Convey the object code using peer-to-peer transmission, provided you inform other peers where the object code and Corresponding Source of the work are being offered to the general public at no charge under subsection 6d.

A separable portion of the object code, whose source code is excluded from the Corresponding Source as a System Library, need not be included in conveying the object code work.



Software License(Continue)



A "User Product" is either (1) a "consumer product", which means any tangible personal property which is normally used for personal, family, or household purposes, or (2) anything designed or sold for incorporation into a dwelling. In determining whether a product is a consumer product, doubtful cases shall be resolved in favor of coverage. For a particular product received by a particular user, "normally used" refers to a typical or common use of that class of product, regardless of the status of the particular user or of the way in which the particular user actually uses, or expects or is expected to use, the product. A product is a consumer product regardless of whether the product has substantial commercial, industrial or non-consumer uses, unless such uses represent the only significant mode of use of the product.

"Installation Information" for a User Product means any methods, procedures, authorization keys, or other information required to install and execute modified versions of a covered work in that User Product from a modified version of its Corresponding Source. The information must suffice to ensure that the continued functioning of the modified object code is in no case prevented or interfered with solely because modification has been made.

If you convey an object code work under this section in, or with, or specifically for use in, a User Product, and the conveying occurs as part of a transaction in which the right of possession and use of the User Product is transferred to the recipient in perpetuity or for a fixed term (regardless of how the transaction is characterized), the Corresponding Source conveyed under this section must be accompanied by the Installation Information. But this requirement does not apply if neither you nor any third party retains the ability to install modified object code on the User Product (for example, the work has been installed in ROM).

The requirement to provide Installation Information does not include a requirement to continue to provide support service, warranty, or updates for a work that has been modified or installed by the recipient, or for the User Product in which it has been modified or installed. Access to a network may be denied when the modification itself materially and adversely affects the operation of the network or violates the rules and protocols for communication across the network.

Corresponding Source conveyed, and Installation Information provided, in accord with this section must be in a format that is publicly documented (and with an implementation available to the public in source code form), and must require no special password or key for unpacking, reading or copying.

7. Additional Terms.

"Additional permissions" are terms that supplement the terms of this License by making exceptions from one or more of its conditions. Additional permissions that are applicable to the entire Program shall be treated as though they were included in this License, to the extent that they are valid under applicable law. If additional permissions apply only to part of the Program, that part may be used separately under those permissions, but the entire Program remains governed by this License without regard to the additional permissions.

When you convey a copy of a covered work, you may at your option remove any additional permissions from that copy, or from any part of it. (Additional permissions may be written to require their own removal in certain cases when you modify the work.) You may place additional permissions on material, added by you to a covered work, for which you have or can give appropriate copyright permission.

Notwithstanding any other provision of this License, for material you add to a covered work, you may (if authorized by the copyright holders of that material) supplement the terms of this License with terms:

- a) Disclaiming warranty or limiting liability differently from the terms of sections 15 and 16 of this License; or
- b) Requiring preservation of specified reasonable legal notices or author attributions in that material or in the Appropriate Legal Notices displayed by works containing it; or
- c) Prohibiting misrepresentation of the origin of that material, or requiring that modified versions of such material be marked in reasonable ways as different from the original version; or
- d) Limiting the use for publicity purposes of names of licensors or authors of the material; or
- e) Declining to grant rights under trademark law for use of some trade names, trademarks, or service marks; or
- f) Requiring indemnification of licensors and authors of that material by anyone who conveys the material (or modified versions of it) with contractual assumptions of liability to the recipient, for any liability that these contractual assumptions directly impose on those licensors and authors.

All other non-permissive additional terms are considered "further restrictions" within the meaning of section 10. If the Program as you received it, or any part of it, contains a notice stating that it is governed by this License along with a term that is a further restriction, you may remove that term. If a license document contains a further restriction but permits relicensing or conveying under this License, you may add to a covered work material governed by the terms of that license document, provided that the further restriction does not survive such relicensing or conveying.

If you add terms to a covered work in accord with this section, you must place, in the relevant source files, a statement of the additional terms that apply to those files, or a notice indicating where to find the applicable terms.



Software License(Continue)



Additional terms, permissive or non-permissive, may be stated in the form of a separately written license, or stated as exceptions; the above requirements apply either way.

8. Termination.

You may not propagate or modify a covered work except as expressly provided under this License. Any attempt otherwise to propagate or modify it is void, and will automatically terminate your rights under this License (including any patent licenses granted under the third paragraph of section 11).

However, if you cease all violation of this License, then your license from a particular copyright holder is reinstated (a) provisionally, unless and until the copyright holder explicitly and finally terminates your license, and (b) permanently, if the copyright holder fails to notify you of the violation by some reasonable means prior to 60 days after the cessation.

Moreover, your license from a particular copyright holder is reinstated permanently if the copyright holder notifies you of the violation by some reasonable means, this is the first time you have received notice of violation of this License (for any work) from that copyright holder, and you cure the violation prior to 30 days after your receipt of the notice.

Termination of your rights under this section does not terminate the licenses of parties who have received copies or rights from you under this License. If your rights have been terminated and not permanently reinstated, you do not qualify to receive new licenses for the same material under section 10.

9. Acceptance Not Required for Having Copies.

You are not required to accept this License in order to receive or run a copy of the Program. Ancillary propagation of a covered work occurring solely as a consequence of using peer-to-peer transmission to receive a copy likewise does not require acceptance. However, nothing other than this License grants you permission to propagate or modify any covered work. These actions infringe copyright if you do not accept this License. Therefore, by modifying or propagating a covered work, you indicate your acceptance of this License to do so.

10. Automatic Licensing of Downstream Recipients.

Each time you convey a covered work, the recipient automatically receives a license from the original licensors, to run, modify and propagate that work, subject to this License. You are not responsible for enforcing compliance by third parties with this License.

An "entity transaction" is a transaction transferring control of an organization, or substantially all assets of one, or subdividing an organization, or merging organizations. If propagation of a covered work results from an entity transaction, each party to that transaction who receives a copy of the work also receives whatever licenses to the work the party's predecessor in interest had or could give under the previous paragraph, plus a right to possession of the Corresponding Source of the work from the predecessor in interest, if the predecessor has it or can get it with reasonable efforts.

You may not impose any further restrictions on the exercise of the rights granted or affirmed under this License. For example, you may not impose a license fee, royalty, or other charge for exercise of rights granted under this License, and you may not initiate litigation (including a cross-claim or counterclaim in a lawsuit) alleging that any patent claim is infringed by making, using, selling, offering for sale, or importing the Program or any portion of it.

11. Patents.

A "contributor" is a copyright holder who authorizes use under this License of the Program or a work on which the Program is based. The work thus licensed is called the contributor's "contributor version".

A contributor's "essential patent claims" are all patent claims owned or controlled by the contributor, whether already acquired or hereafter acquired, that would be infringed by some manner, permitted by this License, of making, using, or selling its contributor version, but do not include claims that would be infringed only as a consequence of further modification of the contributor version. For purposes of this definition, "control" includes the right to grant patent sublicenses in a manner consistent with the requirements of this License.

Each contributor grants you a non-exclusive, worldwide, royalty-free patent license under the contributor's essential patent claims, to make, use, sell, offer for sale, import and otherwise run, modify and propagate the contents of its contributor version.

In the following three paragraphs, a "patent license" is any express agreement or commitment, however denominated, not to enforce a patent (such as an express permission to practice a patent or covenant not to sue for patent infringement). To "grant" such a patent license to a party means to make such an agreement or commitment not to enforce a patent against the party.



Software License(Continue)



If you convey a covered work, knowingly relying on a patent license, and the Corresponding Source of the work is not available for anyone to copy, free of charge and under the terms of this License, through a publicly available network server or other readily accessible means, then you must either (1) cause the Corresponding Source to be so available, or (2) arrange to deprive yourself of the benefit of the patent license for this particular work, or (3) arrange, in a manner consistent with the requirements of this License, to extend the patent license to downstream recipients. "Knowingly relying" means you have actual knowledge that, but for the patent license, your conveying the covered work in a country, or your recipient's use of the covered work in a country, would infringe one or more identifiable patents in that country that you have reason to believe are valid.

If, pursuant to or in connection with a single transaction or arrangement, you convey, or propagate by procuring conveyance of, a covered work, and grant a patent license to some of the parties receiving the covered work authorizing them to use, propagate, modify or convey a specific copy of the covered work, then the patent license you grant is automatically extended to all recipients of the covered work and works based on it.

A patent license is "discriminatory" if it does not include within the scope of its coverage, prohibits the exercise of, or is conditioned on the non-exercise of one or more of the rights that are specifically granted under this License. You may not convey a covered work if you are a party to an arrangement with a third party that is in the business of distributing software, under which you make payment to the third party based on the extent of your activity of conveying the work, and under which the third party grants, to any of the parties who would receive the covered work from you, a discriminatory patent license (a) in connection with copies of the covered work conveyed by you (or copies made from those copies), or (b) primarily for and in connection with specific products or compilations that contain the covered work, unless you entered into that arrangement, or that patent license was granted, prior to 28 March 2007.

Nothing in this License shall be construed as excluding or limiting any implied license or other defenses to infringement that may otherwise be available to you under applicable patent law.

12. No Surrender of Others' Freedom.

If conditions are imposed on you (whether by court order, agreement or otherwise) that contradict the conditions of this License, they do not excuse you from the conditions of this License. If you cannot convey a covered work so as to satisfy simultaneously your obligations under this License and any other pertinent obligations, then as a consequence you may not convey it at all. For example, if you agree to terms that obligate you to collect a royalty for further conveying from those to whom you convey the Program, the only way you could satisfy both those terms and this License would be to refrain entirely from conveying the Program.

13. Use with the GNU Affero General Public License.

Notwithstanding any other provision of this License, you have permission to link or combine any covered work with a work licensed under version 3 of the GNU Affero General Public License into a single combined work, and to convey the resulting work. The terms of this License will continue to apply to the part which is the covered work, but the special requirements of the GNU Affero General Public License, section 13, concerning interaction through a network will apply to the combination as such.

14. Revised Versions of this License.

The Free Software Foundation may publish revised and/or new versions of the GNU General Public License from time to time. Such new versions will be similar in spirit to the present version, but may differ in detail to address new problems or concerns.

Each version is given a distinguishing version number. If the Program specifies that a certain numbered version of the GNU General Public License "or any later version" applies to it, you have the option of following the terms and conditions either of that numbered version or of any later version published by the Free Software Foundation. If the Program does not specify a version number of the GNU General Public License, you may choose any version ever published by the Free Software Foundation.

If the Program specifies that a proxy can decide which future versions of the GNU General Public License can be used, that proxy's public statement of acceptance of a version permanently authorizes you to choose that version for the Program.

Later license versions may give you additional or different permissions. However, no additional obligations are imposed on any author or copyright holder as a result of your choosing to follow a later version.

15. Disclaimer of Warranty.

THERE IS NO WARRANTY FOR THE PROGRAM, TO THE EXTENT PERMITTED BY APPLICABLE LAW. EXCEPT WHEN OTHERWISE STATED IN WRITING THE COPYRIGHT HOLDERS AND/OR OTHER PARTIES PROVIDE THE PROGRAM "AS IS" WITHOUT WARRANTY OF ANY KIND, EITHER EXPRESSED OR IMPLIED, INCLUDING, BUT NOT LIMITED TO, THE IMPLIED WARRANTIES OF MERCHANTABILITY AND FITNESS FOR A PARTICULAR PURPOSE. THE ENTIRE RISK AS TO THE QUALITY AND PERFORMANCE OF THE PROGRAM IS WITH YOU. SHOULD THE PROGRAM PROVE DEFECTIVE, YOU ASSUME THE COST OF ALL NECESSARY SERVICING, REPAIR OR CORRECTION.



Software License(Continue)



16. Limitation of Liability.

IN NO EVENT UNLESS REQUIRED BY APPLICABLE LAW OR AGREED TO IN WRITING WILL ANY COPYRIGHT HOLDER, OR ANY OTHER PARTY WHO MODIFIES AND/OR CONVEYS THE PROGRAM AS PERMITTED ABOVE, BE LIABLE TO YOU FOR DAMAGES, INCLUDING ANY GENERAL, SPECIAL, INCIDENTAL OR CONSEQUENTIAL DAMAGES ARISING OUT OF THE USE OR INABILITY TO USE THE PROGRAM (INCLUDING BUT NOT LIMITED TO LOSS OF DATA OR DATA BEING RENDERED INACCURATE OR LOSSES SUSTAINED BY YOU OR THIRD PARTIES OR A FAILURE OF THE PROGRAM TO OPERATE WITH ANY OTHER PROGRAMS), EVEN IF SUCH HOLDER OR OTHER PARTY HAS BEEN ADVISED OF THE POSSIBILITY OF SUCH DAMAGES.

17. Interpretation of Sections 15 and 16.

If the disclaimer of warranty and limitation of liability provided above cannot be given local legal effect according to their terms, reviewing courts shall apply local law that most closely approximates an absolute waiver of all civil liability in connection with the Program, unless a warranty or assumption of liability accompanies a copy of the Program in return for a fee.

END OF TERMS AND CONDITIONS



SHARP®

SHARP ELECTRONICS CORPORATION

1 Sharp Plaza, Suite 1, Mahwah, New Jersey 07495-1123

SHARP CORPORATION