

SHARP®

AQUOS

LC-70LE845U LC-60LE845U

LIQUID CRYSTAL TELEVISION
TÉLÉVISEUR ACL
TELEVISOR CON PANTALLA
DE CRISTAL LÍQUIDO

OPERATION MANUAL
MODE D'EMPLOI
MANUAL DE OPERACIÓN



ENGLISH

FRANÇAIS

ESPAÑOL



NOM 1245



IMPORTANT : Please read this operation manual before starting operating the equipment.
IMPORTANT : Veuillez lire ce mode d'emploi avant de commencer à utiliser l'appareil.
IMPORTANTE : Lea este manual de operación antes de comenzar a operar el equipo.

LC-70LE845U

LC-60LE845U

LIQUID CRYSTAL TELEVISION

ENGLISH

OPERATION MANUAL

IMPORTANT:

To aid reporting in case of loss or theft, please record the TV's model and serial numbers in the space provided. The numbers are located at the rear and right side of the TV.

Model No.:

Serial No.:

IMPORTANT INFORMATION

WARNING: TO REDUCE THE RISK OF FIRE OR ELECTRIC SHOCK, DO NOT EXPOSE THIS PRODUCT TO RAIN OR MOISTURE.



CAUTION

RISK OF ELECTRIC SHOCK
DO NOT OPEN



CAUTION: TO REDUCE THE RISK OF ELECTRIC SHOCK,
DO NOT REMOVE COVER (OR BACK).
NO USER-SERVICEABLE PARTS INSIDE.
REFER SERVICING TO QUALIFIED SERVICE
PERSONNEL.



The lightning flash with arrow-head symbol, within an equilateral triangle, is intended to alert the user to the presence of uninsulated "dangerous voltage" within the product's enclosure that may be of sufficient magnitude to constitute a risk of electric shock to persons.



The exclamation point within a triangle is intended to alert the user to the presence of important operating and maintenance (servicing) instructions in the literature accompanying the product.

CAUTION: TO PREVENT ELECTRIC SHOCK, MATCH WIDE BLADE OF PLUG TO WIDE SLOT, FULLY INSERT.

WARNING: FCC Regulations state that any unauthorized changes or modifications to this equipment not expressly approved by the manufacturer could void the user's authority to operate this equipment.

IMPORTANT INFORMATION

CAUTION:

This product satisfies FCC regulations when shielded cables and connectors are used to connect the unit to other equipment. To prevent electromagnetic interference with electric appliances such as radios and televisions, use shielded cables and connectors for connections.

DECLARATION OF CONFORMITY:

SHARP LIQUID CRYSTAL TELEVISION, MODEL LC-70LE845U/LC-60LE845U

This device complies with Part 15 of the FCC Rules. Operation is subject to the following two conditions:

(1) This device may not cause harmful interference, and (2) this device must accept any interference received, including interference that may cause undesired operation.

RESPONSIBLE PARTY:

SHARP ELECTRONICS CORPORATION

Sharp Plaza, Mahwah, New Jersey 07495-1163

TEL: 1-800-BE-SHARP

For Business Customers: URL <http://www.sharppusa.com>

INFORMATION:

This equipment has been tested and found to comply with the limits for a Class B digital device, pursuant to Part 15 of the FCC Rules. These limits are designed to provide reasonable protection against harmful interference in a residential installation. This equipment generates, uses and can radiate radio frequency energy and, if not installed and used in accordance with the instructions, may cause harmful interference to radio communications. However, there is no guarantee that interference will not occur in a particular installation. If this equipment does cause harmful interference to radio or television reception, which can be determined by turning the equipment off and on, the user is encouraged to try to correct the interference by one or more of the following measures:

- Reorient or relocate the receiving antenna.
- Increase the separation between the equipment and receiver.
- Connect the equipment into an outlet on a circuit different from that to which the receiver is connected.
- Consult the dealer or an experienced radio/TV technician for help.

FCC Compliance Statement

This device complies with part 15 of the FCC Rules. Operation is subject to the following two conditions:

(1) This device may not cause harmful interference, and (2) this device must accept any interference received, including interference that may cause undesired operation.

Wireless Radio

For product available in the USA/Canada market, only channel 1–11 can be operated. Selection of other channels is not possible. This device is going to be operated in 5.15–5.25GHz frequency range, it is restricted in indoor environment only.

Important: Any changes or modifications not expressly approved by the party responsible for compliance could void the user's authority to operate the equipment.

FCC Radiation Exposure Statement: This equipment complies with FCC radiation exposure limits set forth for an uncontrolled environment. This equipment should be installed and operated with minimum distance 20cm between the radiator & your body.

Industry Canada Statement

This Class B digital apparatus complies with Canadian ICES-003.

Cet appareil numérique de la classe B est conforme à la norme NMB-003 du Canada.

Wireless Radio

For product available in the USA/Canada market, only channel 1–11 can be operated. Selection of other channels is not possible. The device could automatically discontinue transmission in case of absence of information to transmit, or operational failure.

Note that this is not intended to prohibit transmission of control or signaling information or the use of repetitive codes where required by the technology.

Important: Any changes or modifications not expressly approved by the party responsible for compliance could void the user's authority to operate the equipment.

IC Radiation Exposure Statement: This equipment complies with IC RSS-102 radiation exposure limits set forth for an uncontrolled environment. This equipment should be installed and operated with minimum distance 20 cm between the radiator & your body.

"Note to CATV system installer: This reminder is provided to call the CATV system installer's attention to Article 820 of the National Electrical Code that provides guidelines for proper grounding and, in particular, specifies that the cable ground shall be connected to the grounding system of the building, as close to the point of cable entry as practical."

This product qualifies for ENERGY STAR when "Home" is selected for "TV Location". Setting "TV Location" to "Home" allows the TV to achieve an energy-saving status for household use.

DEAR SHARP CUSTOMER

Thank you for your purchase of the Sharp Liquid Crystal Television. To ensure safety and many years of trouble-free operation of your product, please read the Important Safety Instructions carefully before using this product.

IMPORTANT SAFETY INSTRUCTIONS

Electricity is used to perform many useful functions, but it can also cause personal injuries and property damage if improperly handled. This product has been engineered and manufactured with the highest priority on safety. However, improper use can result in electric shock and/or fire. In order to prevent potential danger, please observe the following instructions when installing, operating and cleaning the product. To ensure your safety and prolong the service life of your Liquid Crystal Television, please read the following precautions carefully before using the product.

- 1) Read these instructions.
- 2) Keep these instructions.
- 3) Heed all warnings.
- 4) Follow all instructions.
- 5) Do not use this apparatus near water.
- 6) Clean only with dry cloth.
- 7) Do not block any ventilation openings. Install in accordance with the manufacturer's instructions.
- 8) Do not install near any heat sources such as radiators, heat registers, stoves, or other apparatus (including amplifiers) that produce heat.
- 9) Do not defeat the safety purpose of the polarized or grounding-type plug. A polarized plug has two blades with one wider than the other. A grounding type plug has two blades and a third grounding prong. The wide blade or the third prong are provided for your safety. If the provided plug does not fit into your outlet, consult an electrician for replacement of the obsolete outlet.
- 10) Protect the power cord from being walked on or pinched particularly at plugs, convenience receptacles, and the point where they exit from the apparatus.
- 11) Only use attachments/accessories specified by the manufacturer.
- 12) Use only with the cart, stand, tripod, bracket, or table specified by the manufacturer, or sold with the apparatus. When a cart is used, use caution when moving the cart/apparatus combination to avoid injury from tip-over.
- 13) Unplug this apparatus during lightning storms or when unused for long periods of time.
- 14) Refer all servicing to qualified service personnel. Servicing is required when the apparatus has been damaged in any way, such as power-supply cord or plug is damaged, liquid has been spilled or objects have fallen into the apparatus, the apparatus has been exposed to rain or moisture, does not operate normally, or has been dropped.



Additional Safety Information

- 15) Power Sources—This product should be operated only from the type of power source indicated on the marking label. If you are not sure of the type of power supply to your home, consult your product dealer or local power company. For products intended to operate from battery power, or other sources, refer to the operating instructions.
- 16) Overloading—Do not overload wall outlets, extension cords, or integral convenience receptacles as this can result in a risk of fire or electric shock.
- 17) Object and Liquid Entry—Never push objects of any kind into this product through openings as they may touch dangerous voltage points or short-out parts that could result in a fire or electric shock. Never spill liquid of any kind on the product.
- 18) Damage Requiring Service—Unplug this product from the wall outlet and refer servicing to qualified service personnel under the following conditions:
 - a) When the AC cord or plug is damaged,
 - b) If liquid has been spilled, or objects have fallen into the product,
 - c) If the product has been exposed to rain or water,
 - d) If the product does not operate normally by following the operating instructions.
Adjust only those controls that are covered by the operating instructions as an improper adjustment of other controls may result in damage and will often require extensive work by a qualified technician to restore the product to its normal operation,
 - e) If the product has been dropped or damaged in any way, and
 - f) When the product exhibits a distinct change in performance - this indicates a need for service.
- 19) Replacement Parts—When replacement parts are required, be sure the service technician has used replacement parts specified by the manufacturer or have the same characteristics as the original part. Unauthorized substitutions may result in fire, electric shock, or other hazards.
- 20) Safety Check—Upon completion of any service or repairs to this product, ask the service technician to perform safety checks to determine that the product is in proper operating condition.
- 21) Wall or ceiling mounting—When mounting the product on a wall or ceiling, be sure to install the product according to the method recommended by the manufacturer.

IMPORTANT SAFETY INSTRUCTIONS

- **Outdoor Antenna Grounding** — If an outside antenna is connected to the television equipment, be sure the antenna system is grounded so as to provide some protection against voltage surges and built-up static charges. Article 810 of the National Electrical Code, ANSI/NFPA 70, provides information with regard to proper grounding of the mast and supporting structure, grounding of the lead-in wire to an antenna discharge unit, size of grounding conductors, location of antenna-discharge unit, connection to grounding electrodes, and requirements for the grounding electrode.

EXAMPLE OF ANTENNA GROUNDING AS PER NATIONAL ELECTRICAL CODE, ANSI/NFPA 70

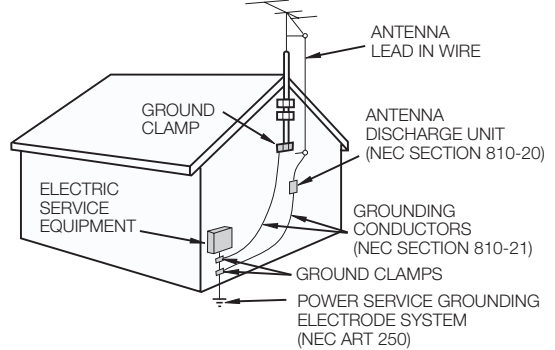

NEC — NATIONAL ELECTRICAL CODE

- **Water and Moisture** — Do not use this product near water - for example, near a bath tub, wash bowl, kitchen sink, or laundry tub; in a wet basement; or near a swimming pool; and the like.
- **Stand** — Do not place the product on an unstable cart, stand, tripod or table. Placing the product on an unstable base can cause the product to fall, resulting in serious personal injuries as well as damage to the product. Use only a cart, stand, tripod, bracket or table recommended by the manufacturer or sold with the product. When mounting the product on a wall, be sure to follow the manufacturer's instructions. Use only the mounting hardware recommended by the manufacturer.
- **Selecting the location** — Select a place with no direct sunlight and good ventilation.
- **Ventilation** — The vents and other openings in the cabinet are designed for ventilation. Do not cover or block these vents and openings since insufficient ventilation can cause overheating and/or shorten the life of the product. Do not place the product on a bed, sofa, rug or other similar surface, since they can block ventilation openings. This product is not designed for built-in installation; do not place the product in an enclosed place such as a bookcase or rack, unless proper ventilation is provided or the manufacturer's instructions are followed.
- The front panel used in this product is made of glass. Therefore, it can break when the product is dropped or applied with impact. Be careful not to be injured by broken glass pieces in case the panel breaks.
- **Heat** — The product should be situated away from heat sources such as radiators, heat registers, stoves, or other products (including amplifiers) that produce heat.
- The Liquid Crystal panel is a very high technology product with 2,073,600 pixels, giving you fine picture details. Occasionally, a few non-active pixels may appear on the screen as a fixed point of blue, green, red or yellow. Please note that this does not affect the performance of your product.
- **Lightning** — For added protection for this television equipment during a lightning storm, or when it is left unattended and unused for long periods of time, unplug it from the wall outlet and disconnect the antenna. This will prevent damage to the equipment due to lightning and power-line surges.
- **Power Lines** — An outside antenna system should not be located in the vicinity of overhead power lines or other electric light or power circuits, or where it can fall into such power lines or circuits. When installing an outside antenna system, extreme care should be taken to keep from touching such power lines or circuits as contact with them might be fatal.
- To prevent fire, never place any type of candle or flames on the top or near the TV set.
- To prevent fire or shock hazard, do not place the AC cord under the TV set or other heavy items.
- Do not display a still picture for a long time, as this could cause an afterimage to remain.
- To prevent fire or shock hazard, do not expose this product to dripping or splashing.
- No objects filled with liquids, such as vases, should be placed on the product.
- Do not insert foreign objects into the product. Inserting objects in the air vents or other openings may result in fire or electric shock. Exercise special caution when using the product around children.

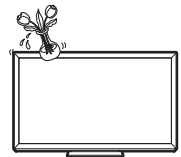

Precautions when transporting the TV

- When transporting the TV, never carry it by holding or otherwise putting pressure onto the display. Be sure to always carry the TV by two people holding it with two hands — one hand on each side of the TV.

Caring for the cabinet

- Use a soft cloth (cotton, flannel, etc.) and gently wipe the surface of the cabinet.
 - Using a chemical cloth (wet/dry sheet type cloth, etc.) may deform the components of the main unit cabinet or cause cracking.
 - Wiping with a hard cloth or using strong force may scratch the surface of the cabinet.
 - If the cabinet is very dirty, wipe with a soft cloth (cotton, flannel, etc.) soaked in neutral detergent diluted with water and thoroughly wrung out, and then wipe with a soft dry cloth.
 - Avoid using benzene, thinner, and other solvents, as these may deform the cabinet and cause the paint to peel off.
 - Do not apply insecticides or other volatile liquids.
- Also, do not allow the cabinet to remain in contact with rubber or vinyl products for a long period of time. Plasticizers inside the plastic may cause the cabinet to deform and cause the paint to peel off.

IMPORTANT SAFETY INSTRUCTIONS

Caring for the front panel

- Turn off the main power and unplug the AC cord from the wall outlet before handling.
- Gently wipe the surface of the front panel with a soft cloth (cotton, flannel, etc.). To protect the front panel, do not use a dirty cloth, liquid cleaners, or a chemical cloth (wet/dry sheet type cloth, etc.). This may damage the surface of the front panel.
- Wiping with a hard cloth or using strong force may scratch the surface of the front panel.
- Use a soft damp cloth to gently wipe the front panel when it is really dirty. (It may scratch the surface of the front panel when wiped strongly.)
- If the front panel is dusty, use an anti-static brush, which is commercially available, to clean it.
- To avoid scratching the frame or screen, please use a soft, lint free cloth for cleaning. Approved cleaning cloths are available directly from Sharp in single (00Z-LCD-CLOTH) or triple (00Z-LCD-CLOTH-3) packs. Call 1-800-BE-SHARP for ordering, or VISIT <http://www.sharpsusa.com/SharpDirect>.

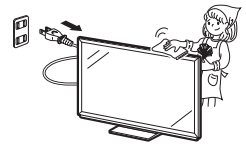

CHILD SAFETY:

It Makes A Difference How and Where You Use Your Flat Panel Display

Congratulations on your purchase! As you enjoy your new product, please keep these safety tips in mind:



THE ISSUE

- The home theater entertainment experience is a growing trend and larger flat panel displays are popular purchases. However, flat panel displays are not always supported on the proper stands or installed according to the manufacturer's recommendations.
- Flat panel displays that are inappropriately situated on dressers, bookcases, shelves, desks, speakers, chests or carts may fall over and cause injury.

THIS MANUFACTURER CARES!

- The consumer electronics industry is committed to making home entertainment enjoyable and safe.

TUNE INTO SAFETY

- One size does NOT fit all. Follow the manufacturer's recommendations for the safe installation and use of your flat panel display.
- Carefully read and understand all enclosed instructions for proper use of this product.
- Don't allow children to climb on or play with furniture and television sets.
- Don't place flat panel displays on furniture that can easily be used as steps, such as a chest of drawers.
- Remember that children can become excited while watching a program, especially on a "larger than life" flat panel display. Care should be taken to place or install the display where it cannot be pushed, pulled over, or knocked down.
- Care should be taken to route all cords and cables connected to the flat panel display so that they cannot be pulled or grabbed by curious children.

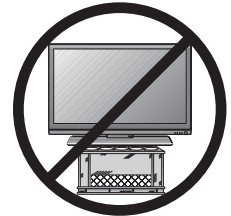

WALL MOUNTING: IF YOU DECIDE TO WALL MOUNT YOUR FLAT PANEL DISPLAY, ALWAYS:

- Use a mount that has been recommended by the display manufacturer and/or listed by an independent laboratory (such as UL, CSA, ETL).
- Follow all instructions supplied by the display and wall mount manufacturers.
- If you have any doubts about your ability to safely install your flat panel display, contact your retailer about professional installation.
- Make sure that the wall where you are mounting the display is appropriate. Some wall mounts are not designed to be mounted to walls with steel studs or old cinder block construction. If you are unsure, contact a professional installer.
- A minimum of two people are required for installation. Flat panel displays can be heavy.



Note: CEA is the preeminent trade association promoting growth in the \$161 billion U.S. consumer electronics industry. More than 2,200 companies enjoy the benefits of CEA membership, including legislative advocacy, market research, technical training and education, industry promotion and the fostering of business and strategic relationships.

IMPORTANT SAFETY INSTRUCTIONS

3D Glasses

Prevention of accidental ingestion

- Keep the accessory out of the reach of small children. Small children can accidentally swallow these parts.
 - If a child accidentally swallows any of these parts, seek immediate medical attention.

Do not disassemble

- Do not disassemble or modify the 3D Glasses except when recycling the batteries. Do not modify the 3D Glasses.

Caution for lithium ion polymer rechargeable battery

- Do not expose the 3D Glasses to excessive heat, such as direct sunlight, fire or in an area with high humidity.

Handling the 3D Glasses

- Do not drop, exert pressure on, or step on the 3D Glasses. Doing so may damage the glass section, which may result in the risk of injury.
- Be careful not to trap your finger in the hinge section of the 3D Glasses. Doing so may result in injury.
 - Pay special attention when children are using this product.

Using the 3D Glasses

- Use of the 3D Glasses should be limited to a maximum of 3 hours, and in any case no more than one movie.
- Use only the 3D Glasses recommended for this TV.
- Use the 3D Glasses only for the specified purpose.
- Do not move around while wearing the 3D Glasses. The surrounding area may appear dark, which may result in falling or other accidents that may cause injury.

Viewing 3D images

- If you experience dizziness, nausea, or other discomfort while viewing 3D images, discontinue use and rest your eyes.
- Do not use the 3D Glasses if they are cracked or broken.

Caution regarding rechargeable battery

- Use the supplied USB cable to connect to a USB terminal of a 3D compatible SHARP TV when recharging. Recharging using other devices may lead to battery damage.

Caution regarding the power supply

- Use the USB cable to connect to a USB terminal of a 3D compatible SHARP TV for supplying power. Supplying power using other devices may lead to heat generation or battery damage.
- During a thunderstorm, to avoid getting an electric shock, do not use the 3D Glasses that are power-supplied via USB, and do unplug the USB cable from both the USB terminal on the TV and the USB terminal on the 3D Glasses.

Contents





IMPORTANT INFORMATION	1-2
DEAR SHARP CUSTOMER	3
IMPORTANT SAFETY INSTRUCTIONS	3-6
Accessories	8
Supplied Accessories	8
Optional Accessories	8
QUICK REFERENCE	
Attaching the Stand	9
QUICK INSTALLATION TIPS	10
Experiencing HD Images	10
Using the Remote Control Unit	10
Preparation	
Antennas	11
Installing Batteries in the Remote Control Unit ...	11
Part Names	
TV (Front/Side)	12
TV (Rear)	12
Remote Control Unit	13
Introduction to Connections	
Types of Connection	14
Displaying an External Equipment Image	14
Connecting to External Equipment	
Connecting a Blu-ray Disc/DVD Player or HD Cable/Satellite Set-top Box	15-16
Connecting a VCR, Game Console, Camcorder or Cable/Satellite Set-top Box ...	16
Connecting a Surround System/Audio System ..	17
Connecting a PC	18
Watching TV	
Turning On/Off the Power	19
Initial Installation	19-22
Direct Button Operation	
INPUT	23
Changing Channels	23
Changing Volume	23
MUTE	23
Sleep Timer	23
FREEZE	23
FLASHBACK	24
SmartCentral	24
NETFLIX	24
AV MODE	24
AUDIO	24-25
Closed Captions and Digital Closed Captions	25
VIEW MODE	26
On-Screen Display Menu	
On-Screen Display Menu Operation	27
Menu Operation Buttons	27
Menu Items	28
Picture Settings	29-30
Audio Settings	31
Power Control	32
System Options	33-35
Initial Setup	36-39
Information	40-42
Enjoying 3D Image Viewing	
Display Methods for 3D and 2D Images	43
Viewing 3D Images	44-45
Configuring the TV Settings to Enhance 3D Image Viewing	45-46
Enjoying Photo/Music/Video Playback	
Connecting a USB Memory Device/ USB Hard Drive	48
Connecting a Home Network (DLNA) Server ...	48
Selecting the Folders to Play Back	49
Playing Back Files on a USB Memory Device/ Home Network (DLNA) Server	50-54
Playing Back Files from a Portable Device or PC	54
Other Viewing Options	
Presetting Remote Control Function	55
Operating the Connected Equipment	55-56
Using AQUOS LINK	
Controlling HDMI Equipment Using AQUOS LINK	57-59
Link Operation Menu	59-60
Using a Smartphone with the TV	61
Using a PC	
Displaying a PC Image on the Screen	62
Adjusting the PC Image	63
Setting Audio Input	63
PC Compatibility Chart	63
Control of the TV	64-65
Using the Internet	
Connecting to the Internet	66
Internet Setup	67-68
AQUOS Advantage Live	68
Entering Text (Software Keyboard)	69
Using the Browser	70-71
Using Applications via the Internet	72-73
Enjoying Skype™	74-77
DISCLAIMERS	78
Appendix	
Removing the Stand	79
Setting the TV on the Wall	80
Troubleshooting	81-82
Troubleshooting - 3D Images	82
Troubleshooting - Error Message	82
Trademarks	83
Specifications	
TV	84
Wireless LAN	85
Information on the Software License for This Product	86-88
Calling for Service	89
LIMITED WARRANTY	89
Dimensional Drawings	
• The dimensional drawings for the LCD TV set are shown on the inside back cover.	

- The illustrations and on-screen displays in this operation manual are for explanation purposes and may vary slightly from the actual operations.
- The examples used throughout this manual are based on the LC-70LE845U model.

Accessories

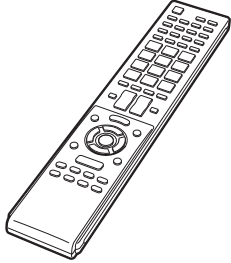
Supplied Accessories

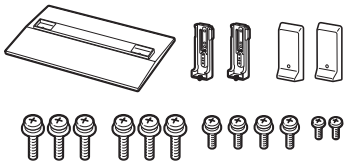
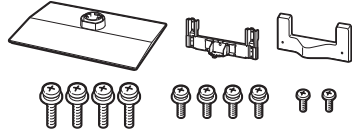
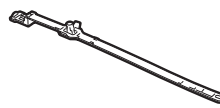
Make sure the following accessories are provided with the product.

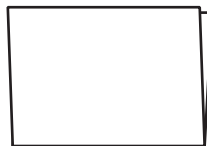
Remote control unit (x1)	“AAA” size battery (x2)	Stand unit (x1) (for LC-70LE845U)
 <p>Page 10</p>	 <p>Page 11</p>	 <p>Page 9</p>
Stand unit (x1) (for LC-60LE845U)	Cable tie (x1)	Operation manual (x1)
 <p>Page 9</p>	 <p>Page 10</p>	
Connection guide (x1)		
		

NOTE

- Always use the AC cord supplied with the TV.
- The illustrations above are for explanation purposes and may vary slightly from the actual accessories.

Optional Accessories

The listed optional accessories are available for the Liquid Crystal Television. Please purchase them at your nearest shop.

- Additional optional accessories may be available in the near future. When purchasing, please read the newest catalogue for compatibility and check the availability.

Part name	Model number
Wall mount bracket	AN-52AG4
3D Glasses	AN-3DG20

QUICK REFERENCE

Attaching the Stand

- Before attaching (or detaching) the stand, unplug the AC cord.
- Before performing work spread cushioning over the base area to lay the TV on. This will prevent it from being damaged.

CAUTION

- **Be sure to follow the instructions. Incorrect installation of the stand may result in the TV falling over.**

■ LC-70LE845U

- 1 Confirm that there are 12 screws (6 long screws, 4 middle screws and 2 short screws) supplied with the stand unit.
- 2 ① Set the post for the stand unit onto the polystyrene foam.
② Attach the base to the post.
③ Insert and tighten the 6 screws into the 6 holes on the bottom of the base.
 - Hold the stand unit securely with one hand, and then tighten the screws.

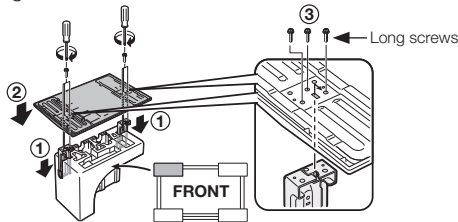

- 3 Insert the stand into the openings on the rear of the TV.
 - Make sure that the stand is firmly inserted into the TV. Improper installation may result in tilting of the TV set.

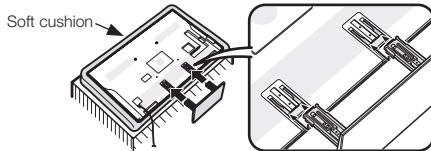

- 4 Insert and tighten the 4 screws into the 4 holes on the rear of the stand unit.

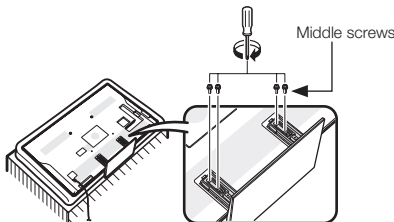

- 5 ① Insert the stand cover.
② Insert the 2 screws to secure the stand cover.

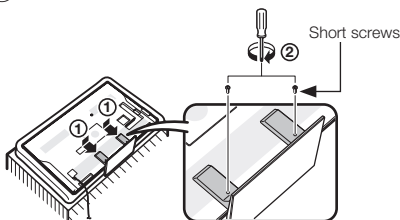

■ LC-60LE845U

- 1 Confirm that there are 10 screws (4 long screws, 4 middle screws and 2 short screws) supplied with the stand unit.
- 2 ① Attach the supporting post for the stand unit onto the base.
② Insert and tighten the 4 screws into the 4 holes on the top of the supporting post.
 - The supporting post attaches to the base at an off-centered location on the base. Be sure to attach the supporting post in the direction indicated below and attach the stand to the TV with the wider side of the base facing forward.

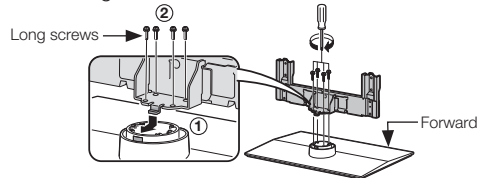

- 3 Insert the stand into the openings on the rear of the TV.
 - Make sure that the stand is firmly inserted into the TV. Improper installation may result in tilting of the TV set.

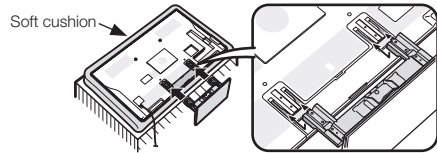

- 4 Insert and tighten the 4 screws into the 4 holes on the rear of the stand unit.

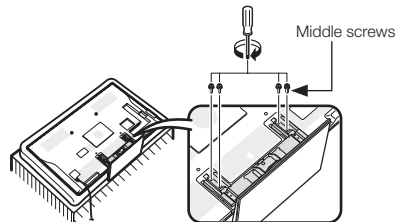

- 5 ① Insert the stand cover.
② Insert the 2 screws to secure the stand cover.

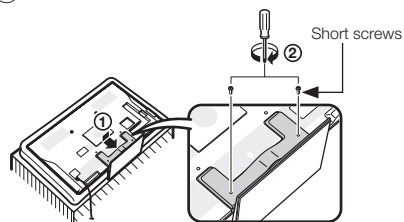

• In the installation procedure, be careful not to catch your fingers between the TV set and the floor.

- **Do not remove the stand from the TV unless using an optional wall mount bracket to mount it.**
- **After attaching the stand to the TV, do not hold the stand when you put up, set up, move or lay down the TV. (For LC-70LE845U)**

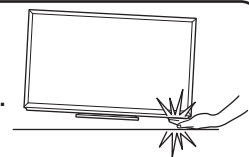

QUICK REFERENCE

QUICK INSTALLATION TIPS

- 1 Attach your antenna to the back of the television. (See page 11.)
- 2 Connect the AC plug for the television into the AC outlet.

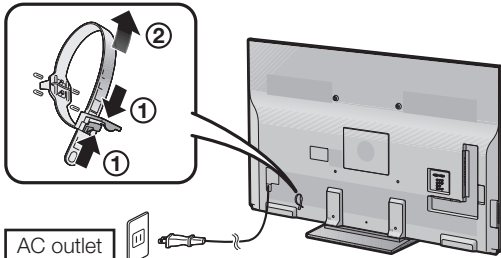

- Place the TV close to the AC outlet, and keep the power plug within reach.

NOTE

- **TO PREVENT RISK OF ELECTRIC SHOCK, DO NOT TOUCH UN-INSULATED PARTS OF ANY CABLES WITH THE AC CORD CONNECTED.**

- 3 Bundle the cords properly with the cable tie.

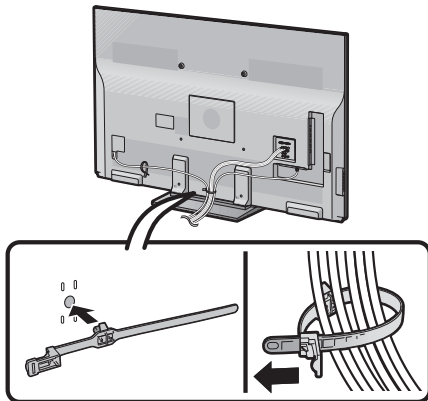

- 4 When turning on the TV for the first time, press **POWER** on the television.

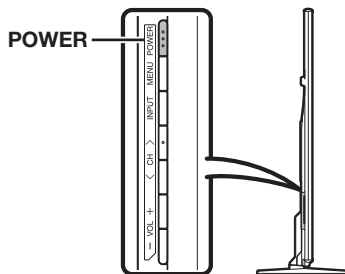

- 5 Insert the batteries into the remote control unit. (See page 11.)

NOTE

- Speakers cannot be detached from the TV.
- The TV angle cannot be adjusted. (For LC-70LE845U)
- The TV can be rotated up to 20 degrees to right and left. (For LC-60LE845U)

Experiencing HD Images

An HDTV without an HD source is just an ordinary TV.

To enjoy HD images on the TV, you should get HD programming from the following:

- Over-the-air broadcasting via HD quality antenna
- HD cable/satellite subscription
- HD compatible external equipment

NOTE

- For information on updating to HD programming, ask your cable/satellite service provider.

Using the Remote Control Unit

Use the remote control unit by pointing it towards the remote control sensor on the TV. Objects between the remote control unit and the remote control sensor may prevent proper operation.

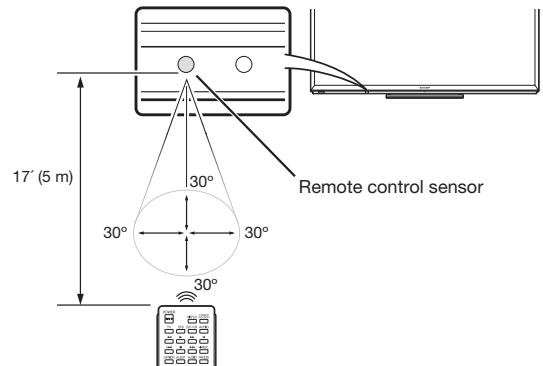

■ Cautions regarding the remote control unit

- Do not expose the remote control unit to shock. In addition, do not expose the remote control unit to liquids, and do not place in an area with high humidity.
- Do not install or place the remote control unit under direct sunlight. The heat may cause deformation of the remote control unit.
- The remote control unit may not work properly if the remote control sensor on the TV is under direct sunlight or strong lighting. In such cases, change the angle of the lighting or the TV, or operate the remote control unit closer to the remote control sensor.

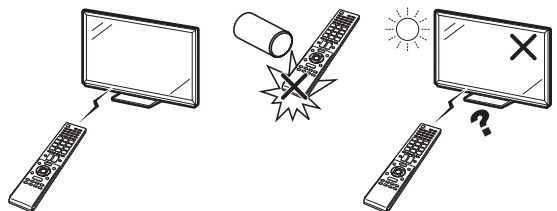

IMPORTANT:

IF THE UNIT DOES NOT POWER ON - UNPLUG THE TELEVISION FROM THE OUTLET AND REPEAT THE INSTALLATION STEPS.

IF YOU STILL ENCOUNTER NO POWER, PLEASE CONTACT US AT 1-800-BE-SHARP.

Preparation

Antennas

To enjoy a clearer picture, use an outdoor antenna. The following is a brief explanation of the types of connections that are used for a coaxial cable. If your outdoor antenna uses a 75-ohm coaxial cable with an F-type connector, plug it into the antenna terminal at the rear of the TV set. For connecting the antenna cable to the TV, use commercially available cables.

Connecting Antenna Cable

• Connect the antenna cable to the TV using one of the methods in the illustration as shown (①, ②, ③ or ④).

① Cable without a CATV converter

② VHF/UHF antenna

③ Combination VHF/UHF antenna

④ Separate VHF/UHF antenna

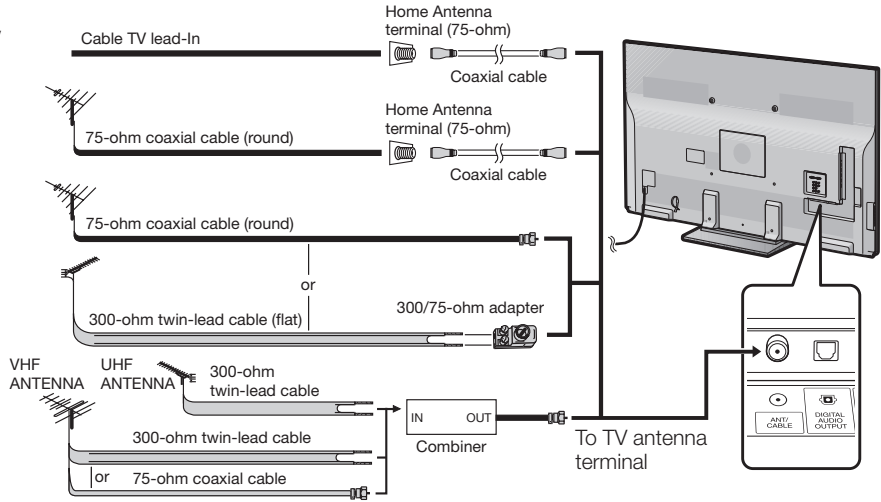

1. A 75-ohm system is generally a round cable with F-type connector that can easily be attached to a terminal without tools.

2. A 300-ohm system is a flat "twin-lead" cable that can be attached to a 75-ohm terminal through a 300/75-ohm adapter.

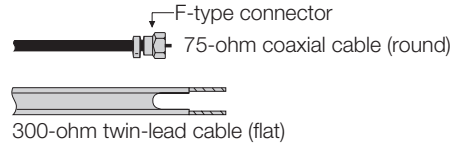

NOTICE F-type connector should be finger-tightened only.

When connecting the RF cable to the TV set, do not tighten F-type connector with tools. If tools are used, it may cause damage to your TV set. (The breaking of internal circuit, etc.)

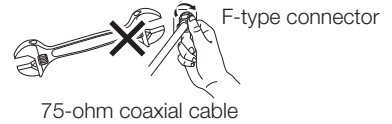

Installing Batteries in the Remote Control Unit

If the remote control fails to operate TV functions, replace the batteries in the remote control unit.

1 Open the battery cover.

2 Insert two "AAA" size batteries (supplied with the product).

3 Close the battery cover.

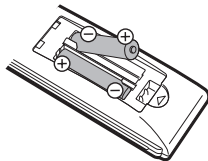
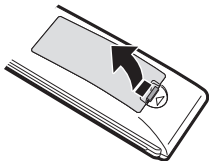

- Place the batteries with their terminals corresponding to the (+) and (-) indications in the battery compartment.

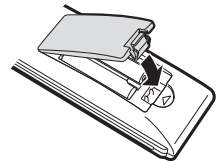

CAUTION

Improper use of batteries can result in chemical leakage or explosion. Be sure to follow the instructions below.

- Do not mix batteries of different types. Different types of batteries have different characteristics.
- Do not mix old and new batteries. Mixing old and new batteries can shorten the life of new batteries or cause chemical leakage in old batteries.
- Remove batteries as soon as they are worn out. Chemicals that leak from batteries that come in contact with skin can cause a rash. If you find any chemical leakage, wipe thoroughly with a cloth.
- The batteries supplied with this product may have a shorter life expectancy due to storage conditions.
- If you will not be using the remote control unit for an extended period of time, remove batteries from it.

Part Names

TV (Front/Side)

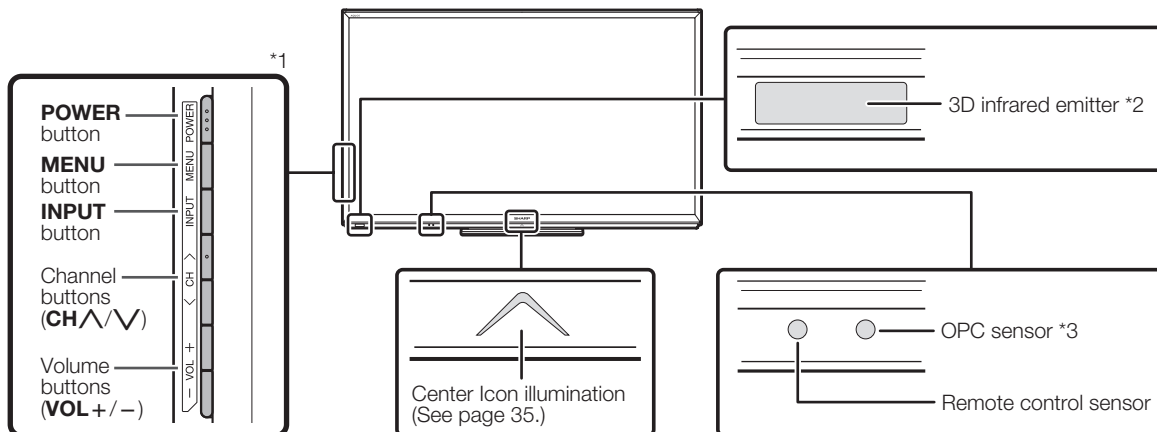

*1 See pages 14, 19 and 27 for button operations.

*2 This panel emits the infrared signal towards the 3D Glasses you wear when you view 3D images.

Do not place anything between the 3D infrared emitter on the TV and the infrared receiver on the 3D Glasses.

When the TV is in 3D mode, the emitter may look reddish.

*3 OPC: Optical Picture Control (See page 29.)

TV (Rear)

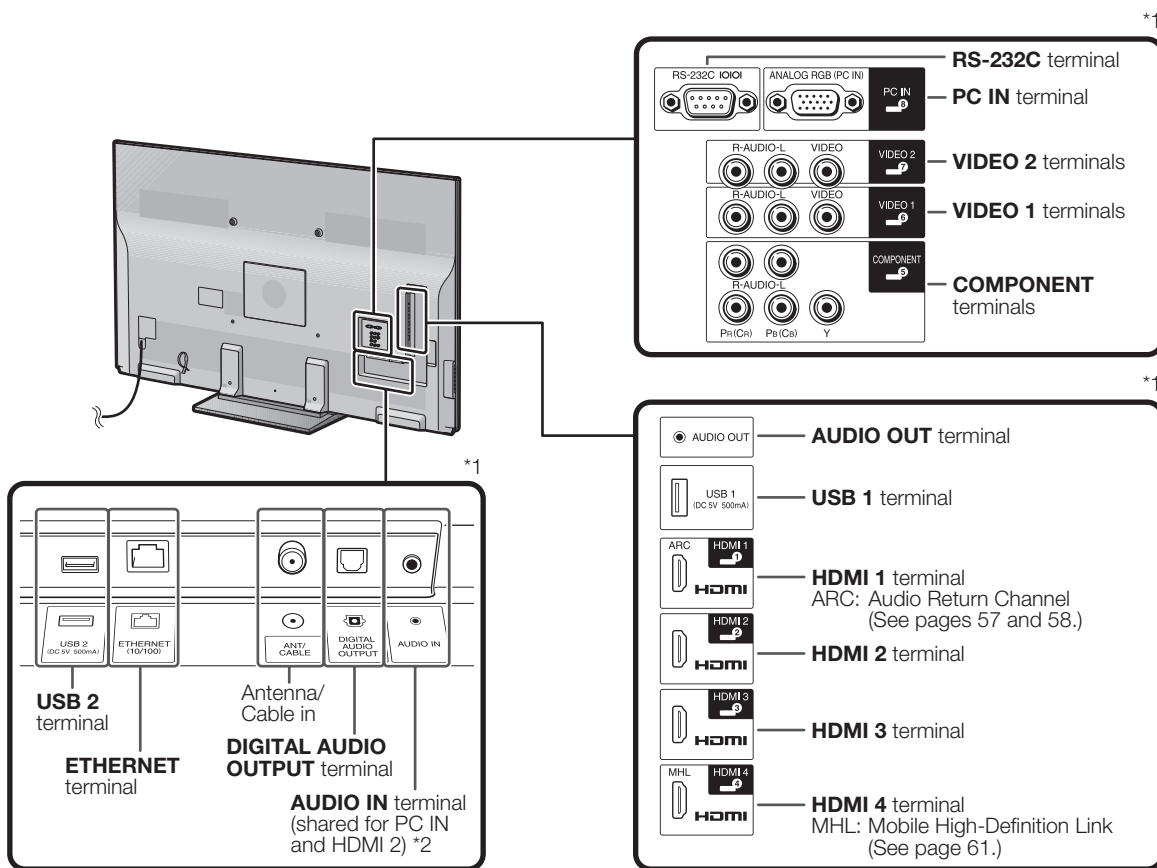

*1 See pages 14 to 18 and 57 for external equipment connection.

*2 See page 63 for details on the Audio Select function.

Remote Control Unit

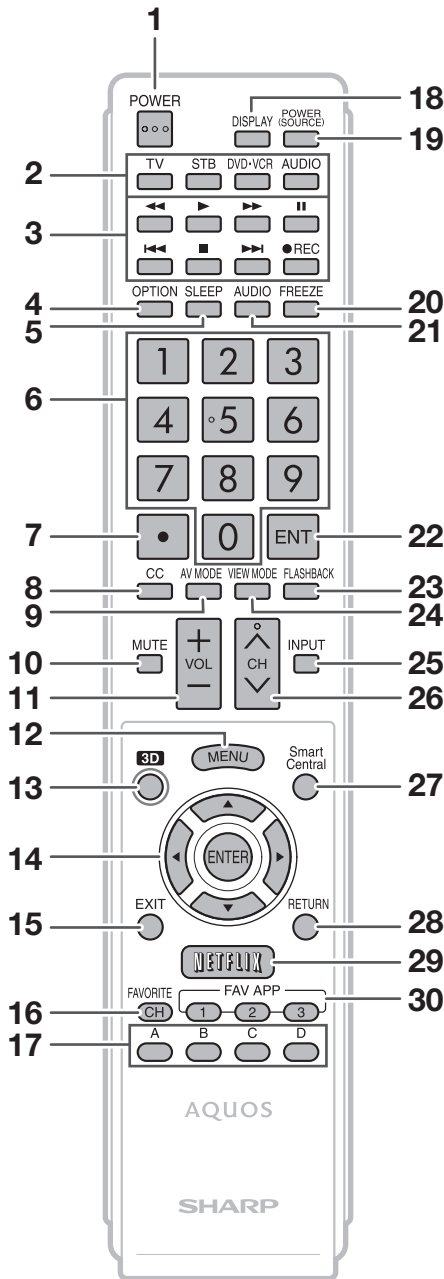

NOTE

- When using the remote control unit, point it at the TV.

- 1 POWER:** Switch the TV power on or enter standby. (See page 19.)
- 2 TV, STB, DVD•VCR, AUDIO:** Switches the remote control for TV, STB, BD, DVD, VCR and AUDIO operation. (See pages 55 to 56 for details.)
* To enter the code registration mode, you need to press an appropriate button (**STB**, **DVD•VCR** or **AUDIO**) and **DISPLAY** at the same time.
- 3 External equipment operational buttons:** Operate the external equipment.
- 4 OPTION:** Display the Link Operation Menu screen. This button will function only when AQUOS LINK is used. (See pages 57 to 60 for details.)
- 5 SLEEP:** Set the sleep timer. (See page 23.)
- 6 0-9:** Set the channel. (See page 23.)
- 7 • (DOT):** (See pages 23 and 55.)
- 8 CC:** Display captions from a closed-caption source. (See page 25.)
- 9 AV MODE:** Select an audio or video setting. (See page 24.)
- 10 MUTE:** Mute the sound. (See page 23.)
- 11 VOL + / - :** Set the volume. (See page 23.)
- 12 MENU:** Display the menu screen. (See page 27.)
- 13 3D:** Select between 3D and 2D image viewing. (See pages 44 to 45 for details.)
- 14 ▲/▼/◀/▶, ENTER:** Select a desired item on the screen.
- 15 EXIT:** Turn off the menu screen.
- 16 FAVORITE CH:** Set the favorite channels. (See page 37.)
While watching, you can toggle the selected channels by pressing **A**, **B**, **C** and **D**.
- 18 DISPLAY:** Display the channel information.
- 19 POWER (SOURCE):** Turns the power of the external equipment on and off.
- 20 FREEZE:** Set the still image. Press again to return to normal screen. (See page 23.)
- 21 AUDIO:** Selects the MTS/SAP or the audio mode during multichannel audio broadcasts. (See pages 24 to 25.)
- 22 ENT:** Jumps to a channel after selecting with the **0-9** buttons.
- 23 FLASHBACK:** Return to the previous channel or external input mode. (See page 24.)
- 24 VIEW MODE:** Select the screen size. (See pages 26 and 62.)
- 25 INPUT:** Select a TV input source. (TV, HDMI1, HDMI2, HDMI3, HDMI4, COMPONENT, VIDEO1, VIDEO2, PC IN, Home Network (DLNA), USB) (See pages 14 and 23.)
- 26 CH ▲/▼:** Select the channel. (See page 23.)
- 27 SmartCentral:** Display the application window. (See page 24.)
- 28 RETURN:** Return to the previous menu screen.
- 29 NETFLIX:** Display the Netflix screen. (See page 24.)
- 30 FAV APP 1, 2, 3:** You can assign your favorite applications to these buttons. (See page 72.)

Introduction to Connections

Types of Connection

For connecting the TV to external equipment, use commercially available cables.

- The illustrations of the terminals are for explanation purposes and may vary slightly from the actual products.

■ Connecting to video equipment or PC

Image quality differs depending on the terminal used. To enjoy clearer images, check the output terminals of your external equipment and use its appropriate terminals for higher quality images.

Image Quality	Terminal on the TV	Cable	Terminal on external equipment	
 HD Quality		HDMI-certified cable		→ Pages 15, 17, 18
		Ø 3.5 mm stereo minijack cable DVI-HDMI conversion cable		→ Pages 15, 18
		Component video cable		→ Page 16
		Audio cable AV cable		→ Page 16
Standard Quality				

■ Connecting to audio equipment

Terminal on the TV	Cable	Terminal on external equipment	
	Optical fiber cable		→ Page 17
	Ø3.5 mm stereo minijack to RCA audio cable		→ Page 17

Displaying an External Equipment Image

To view external source images, select the input source by pressing **INPUT** on the remote control unit or on the TV.

INPUT

Example

- Press **INPUT**.
 - The INPUT list screen displays.
- Press **▲/▼** to select the input source.
 - You can also select the input source by pressing **INPUT**. Each time **INPUT** is pressed, the input source toggles.
 - An image from the selected source automatically displays.
 - If the corresponding input is not plugged in, you cannot change the input. Be sure to connect the equipment beforehand.

Connecting to External Equipment

You can connect many types of external equipment to your TV. To view external source images, select the input source from **INPUT** on the remote control unit or on the TV. (See pages 14 and 23.)

For connecting the TV to external equipment, use commercially available cables.

CAUTION

- To protect equipment, always turn off the TV before connecting any external equipment.
- Please read the relevant operation manual (Blu-ray disc player, etc.) carefully before making connections.

Connecting a Blu-ray Disc/DVD Player or HD Cable/Satellite Set-top Box

■ When using HDMI cable (HDMI 1, 2, 3 or 4):

The HDMI (High Definition Multimedia Interface) terminal is an audio-video interface that enables a connection for audio and video signals using a single cable. The HDMI terminal supports high-resolution video input.

- Blu-ray disc player
- DVD player
- HD cable/satellite set-top box

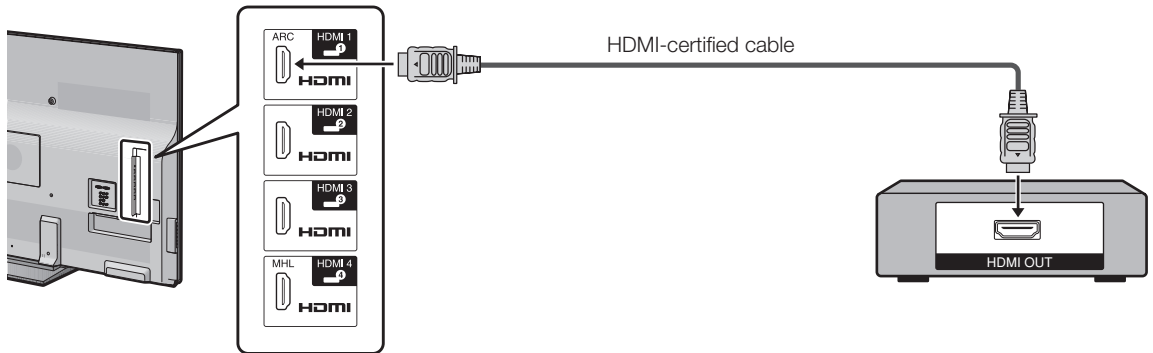

NOTE

- To enjoy 1080p display capability, connect your external equipment using an HDMI-certified cable or a component cable and set the equipment to 1080p output.
- Supported Audio format: Linear PCM/Dolby Digital, sampling rate 32/44.1/48kHz.
- When you connect ARC-compatible equipment, use HDMI 1.

■ When using DVI-HDMI conversion cable (HDMI 2):

- Blu-ray disc player
- DVD player
- HD cable/satellite set-top box

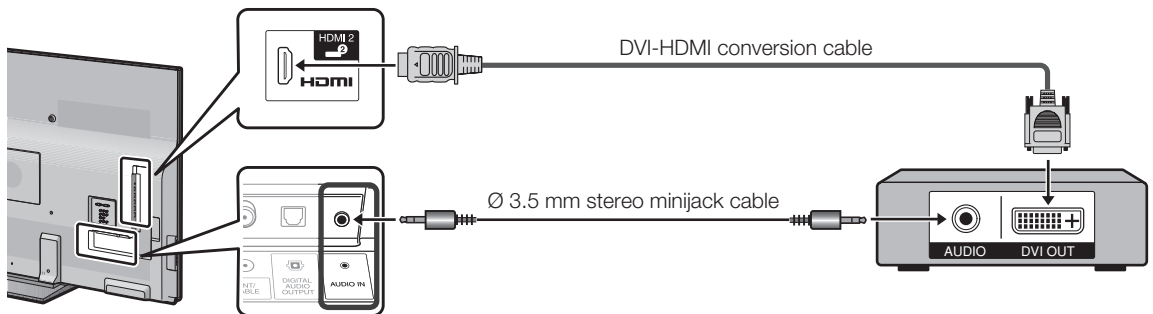

NOTE

- When using a DVI-HDMI conversion cable, you should make an analog audio connection. In this case, in addition to connecting a DVI-HDMI conversion cable to the HDMI 2 terminal, connect a \varnothing 3.5 mm stereo minijack cable to the AUDIO IN terminal and set "Audio Select" to "HDMI+Analog". (See page 63.)

Connecting to External Equipment

■ When using Component cable (COMPONENT):

- Blu-ray disc player
- DVD player
- HD cable/satellite set-top box

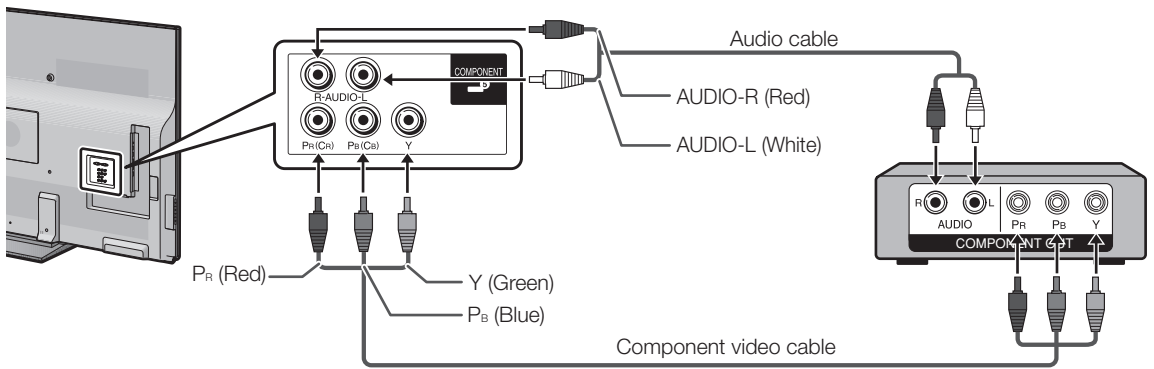

NOTE

- To enjoy 1080p display capability, connect your external equipment using an HDMI-certified cable or a component cable and set the equipment to 1080p output.
- See page 15 for connecting a Blu-ray disc player, DVD player or an HD cable/satellite set-top box to the HDMI terminal.

Connecting a VCR, Game Console, Camcorder or Cable/Satellite Set-top Box

■ When using Composite cable (VIDEO 1 or 2):

- Game console
- VCR
- Camcorder
- Cable/Satellite set-top box

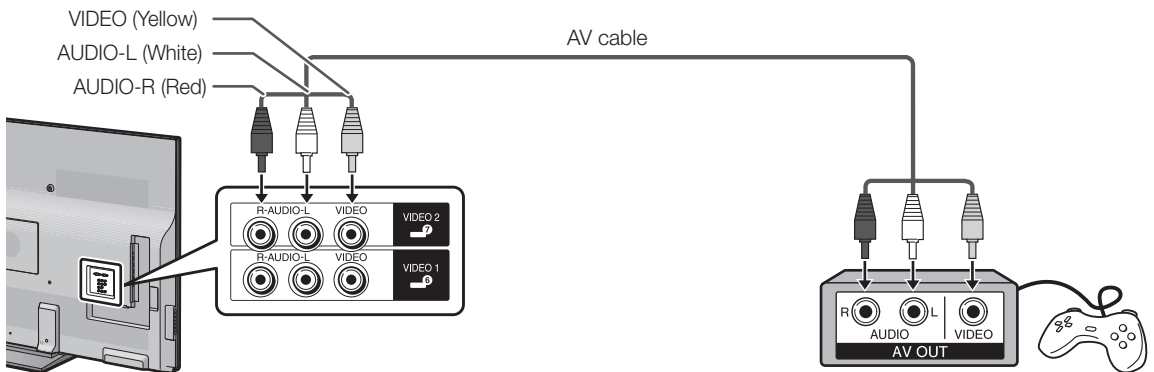

Connecting to External Equipment

Connecting a Surround System/Audio System

■ When connecting an AV amplifier for surround system

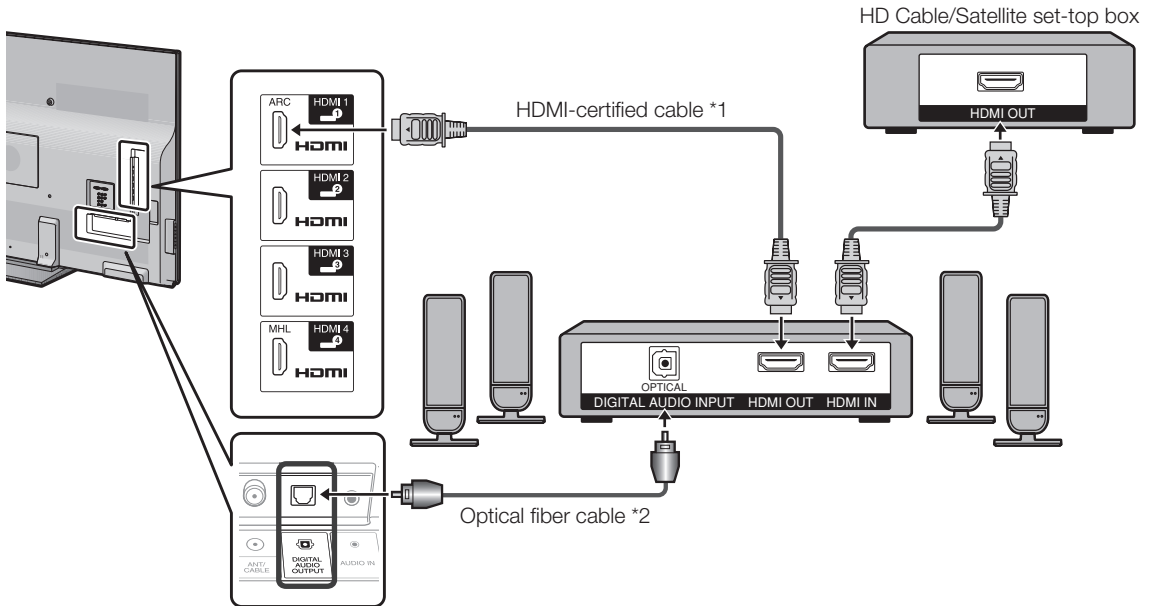

- Letting the TV output the audio to an AV amplifier:

*1 When you connect ARC-compatible equipment, use the HDMI 1 terminal.

*2 If the equipment to be connected is not compatible with the ARC, connect an optical fiber cable.

NOTE

- If the image is not in sync with the audio, check the settings of the connected surround system.

■ When connecting an Audio amplifier

It is possible to output audio through the DIGITAL AUDIO OUTPUT terminal. (See page 33 for details.)

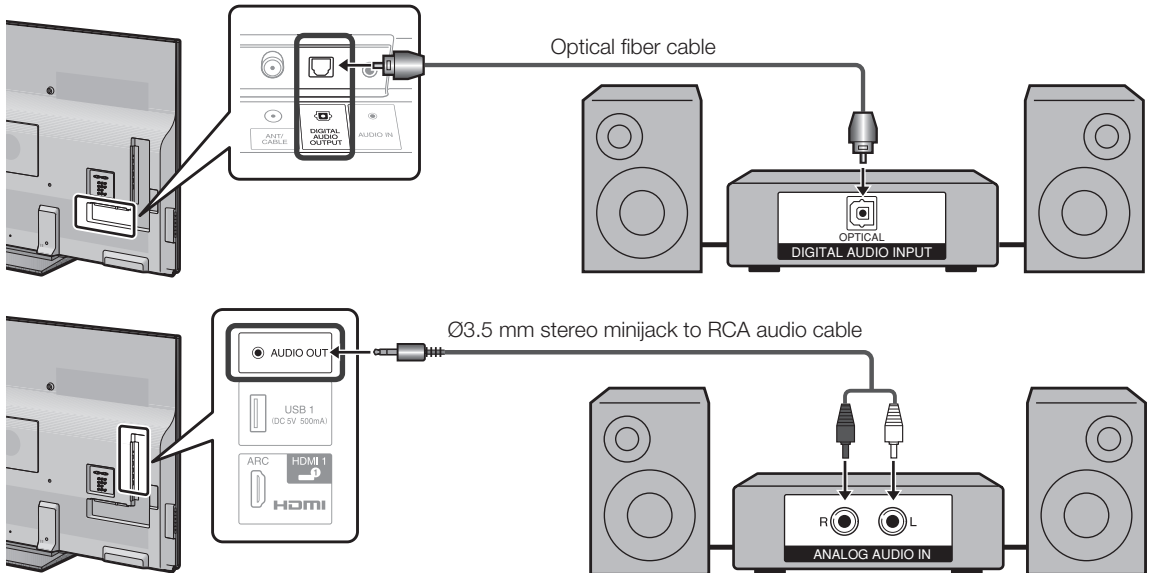

NOTE

- See page 34 for details on the Output Select function.

Connecting to External Equipment

Connecting a PC

Refer to page 63 for a list of PC signals compatible with the TV.

■ When using HDMI cable (HDMI 1, 2, 3 or 4):

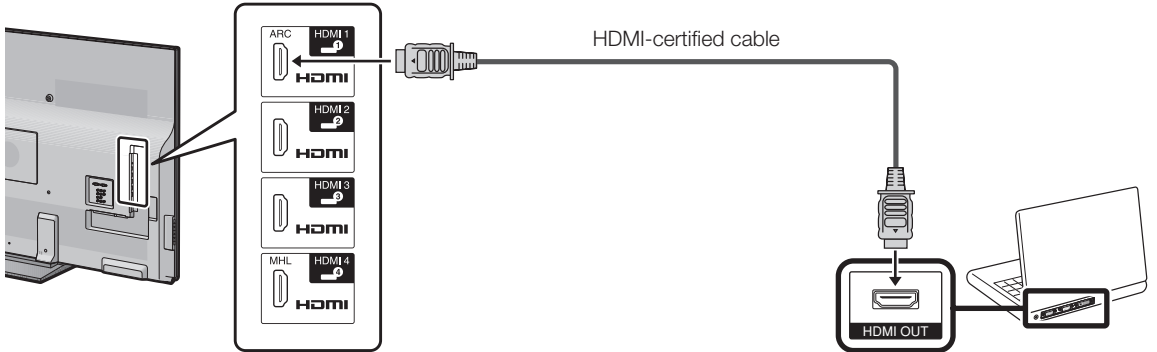

NOTE

- Depending on the board, only video signals may be output. In this case, in addition to connecting an HDMI-certified cable to the HDMI 2 terminal, connect a \varnothing 3.5 mm stereo minijack cable to the AUDIO IN terminal and set "Audio Select" to "HDMI+Analog". (See page 63.)
- The HDMI terminals only support digital signal.

■ When using DVI-HDMI conversion cable (HDMI 2):

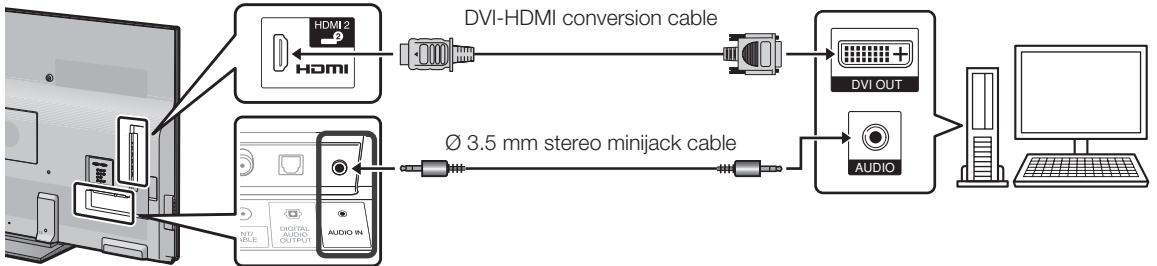

NOTE

- When using a DVI-HDMI conversion cable, you should make an analog audio connection. In this case, in addition to connecting a DVI-HDMI conversion cable to the HDMI 2 terminal, connect a \varnothing 3.5 mm stereo minijack cable to the AUDIO IN terminal and set "Audio Select" to "HDMI+Analog". (See page 63.)

■ When using analog RGB cable (PC IN):

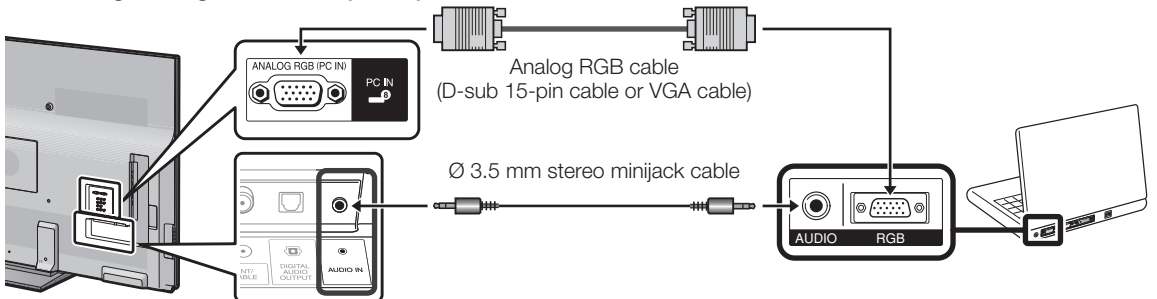

NOTE

- When using an analog RGB cable, input the audio signal to the AUDIO IN terminal of PC IN.
- When connecting a PC to the PC IN, set "Audio Select" to "Video+Audio". (See page 63.)

Watching TV

Turning On/Off the Power

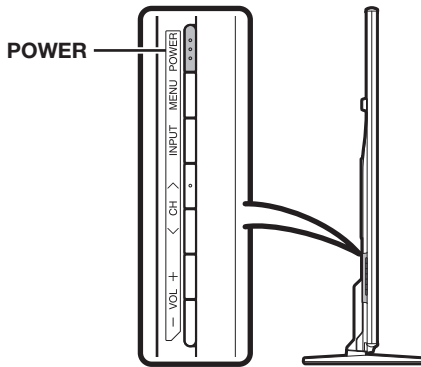

POWER (On/Standby)

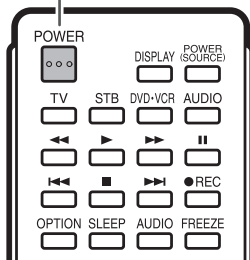

Press **POWER** on the TV or on the remote control unit to turn the power on.

NOTE

- The Initial Installation starts when the TV powers on for the first time. If the TV has been turned on before, the Initial Installation will not be invoked. For changing the settings of the Initial Installation, perform "EZ setup" on the Initial Setup menu on page 36.

Press **POWER** on the TV or on the remote control unit again to turn the power off.

- The TV enters standby and the image on the screen disappears.

NOTE

- If you are not going to use this TV for a long period of time, be sure to remove the AC cord from the AC outlet.
- Weak electric power is still consumed even when the TV is turned off.

Initial Installation

When you turn on the TV for the first time, it will automatically memorize the broadcasting channels available in the region where you live. Perform the following steps before you press **POWER** on the remote control unit.

1. Insert the batteries into the remote control unit. (See page 11.)
2. Connect the antenna cable to the TV. (See page 11.)
3. Plug in the AC cord to the AC outlet. (See page 10.)

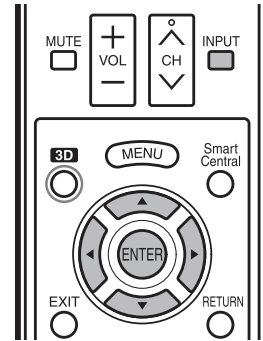

Language (Language setting)

Select from among 3 languages: English, French and Spanish.

- 1 Press **▲/▼** to select the desired language listed on the screen, and then press **ENTER**.



Location & Time

Make settings for the country, area and time zone where you use the TV.

- 2 Press **▲/▼** to select "United States", "Canada" or "Mexico", and then press **ENTER**.

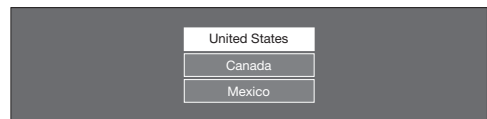

Watching TV

- 3 Press ▲/▼ to select the time zone where you are using the TV, and then press **ENTER**.

Example



- The time zone differs depending on the selected country.
 - The factory preset value is the time zone for the capital of the selected country.
- 4 Press ▲/▼ to select the Daylight Savings Time, and then press **ENTER**.

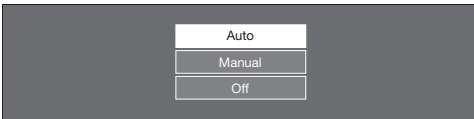

- "Auto" is the default selection.

TV Location

Select "Home" or "Store" for the location where you plan to install the TV. This product qualifies for ENERGY STAR in Home mode default setting.

- 5 Press ◀/▶ to select "Home" or "Store". Press **ENTER** to enter the setting.



Home: "Power Saving" is set to "Advanced", and AV MODE is set to "STANDARD".

Store: "Power Saving" is set to "Off" and AV MODE is set to "DYNAMIC (Fixed)". Picture Reset and Feature Demo can be set.

Picture Reset: AV MODE will be set to "DYNAMIC (Fixed)" regardless of whether Picture Reset is "On" or "Off".

- If you select "On" and there is no operation for 30 minutes:
 - AV MODE will be reset to "DYNAMIC (Fixed)" and, when a 3D signal is detected, 3D images will switch to 2D images.
- When "Off" is selected:
 - AV MODE will be set to "DYNAMIC (Fixed)".

Feature Demo: When "On" is selected, after all the settings are completed, the Feature Demo screen is displayed if there is no operation for several minutes.

NOTE

- ENERGY STAR qualification is based on AV MODE "STANDARD".

Antenna & Cable/STB

Select the type of connection you will use to watch TV.

- 6 Press ◀/▶ to select "Antenna & Cable" or "Set-top box", and then press **ENTER**.

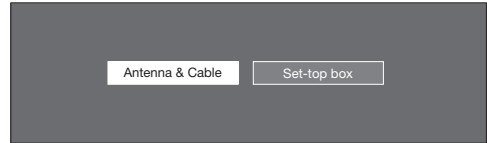

To watch TV via an antenna or cable connection (without using a set-top box):

Select "Antenna & Cable", and then go to step 7.

To watch TV via a set-top box:

- ① Select "Set-top box", and then press **ENTER**.
- ② To watch TV, select the input source corresponding to the terminal connected to the set-top box. When doing so, you must make the setting to skip "TV". Press ◀/▶ to select "On", and then press **ENTER**.



- When this is set to "On", the channel on the TV cannot be changed using the remote control unit or menu. (e.g. CH ▲/▼, Favorite CH, etc.)
 - See page 34 for details on the Input Skip function.
- ③ Press **INPUT** to select the input source corresponding to the terminal connected to the set-top box. Make the necessary settings on the connected external equipment.
 - See the operation manual of the connected equipment for setting up the equipment.

Air/Cable (Antenna setting)

Make sure what kind of connection is made with your TV when selecting "Air" or "Cable".

- 7 Press ◀/▶ to select "Air" or "Cable". Press **ENTER** to enter the setting.

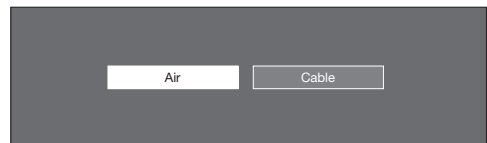

Watching TV

CH Search (Channel search)

Channel auto search makes the TV look for all channels viewable in the set area.

- 8 When "Air" is selected in Antenna setting:**
Press ◀/▶ to select "Start", and then press **ENTER**.

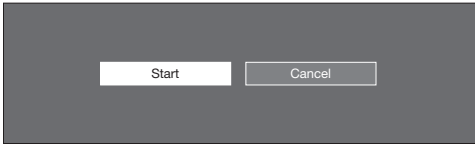

When "Cable" is selected in Antenna setting:

- ① Press ▲/▼ to select "Analog & Digital Search Start" to search both analog and digital broadcasts, or to select "Analog Search Start" to search only analog broadcasts, and then press **ENTER**.

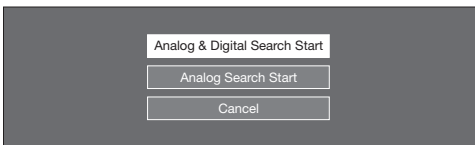

- The Channel search will start automatically.
 - To exit the Channel search screen, select "Cancel", and then press **ENTER**.
- ② The Channel search results may include scrambled channels or channels that are not viewable in the set area. Press ◀/▶ to select "Yes", and then press **ENTER** to remove scrambled channels.



Network

When you connect to the Internet on the TV, select the desired connection method and follow the instructions shown on the display.

- Wireless LAN connection is possible only when the WPS (push button) method is used. If any other method is used, make settings by Initial Setup > Internet Setup > Network Setup. (See page 67.)

- 9** Press ◀/▶ to select "Yes", and then press **ENTER**.



- 10** Press ▲/▼ to select "Wired" or "Wireless", and then press **ENTER**.

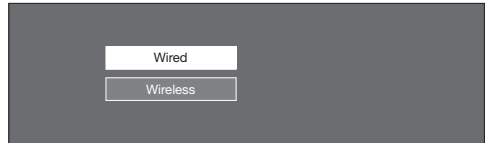

Connection using an ETHERNET cable:

- ① Select "Wired" and press **ENTER**.
- ② Confirm that the TV is properly connected with the router, and then press "Next". Follow the instructions on the display to perform the connection test.

Wireless LAN connection by the WPS method:

- ① Select "Wireless" and press **ENTER**.
- ② Follow the instructions on the display, and finalize the connection after testing its viability.

NOTE

- When you change the network settings, refer to Initial Setup > Internet Setup > Network Setup. (See page 67.)

Completed

- 11** The settings confirmation screen is displayed. Confirm the information displayed on the screen, and then press **ENTER**.

Examples of the settings confirmation screen

When one or more channel is received after "Antenna & Cable" was selected in step 6 and a search was carried out.

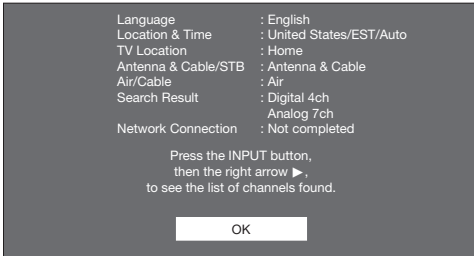

When no channel is received after "Antenna & Cable" was selected in step 6 and a search was carried out.

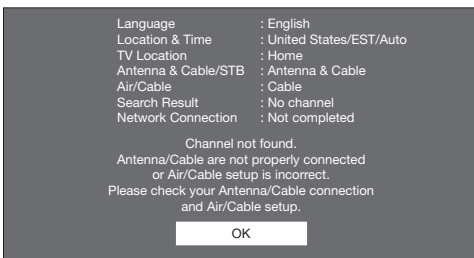

When "Set-top box" was selected in step 6 and a search was carried out.

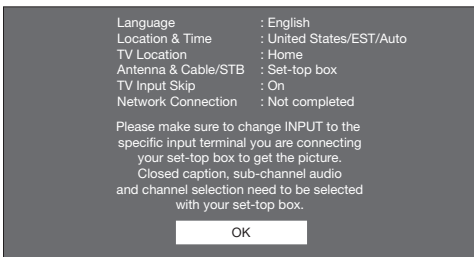

When you have made network settings in step 9.

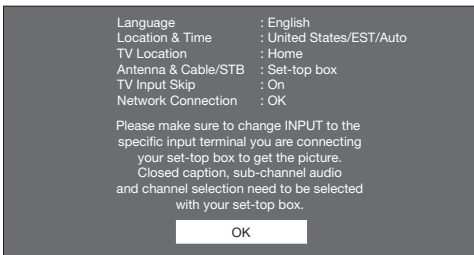

NOTE

- If no channel is found, confirm the type of connection made with your TV and try "EZ Setup" again. (See page 36.)
- For changing the settings of the Initial Installation, perform "EZ setup" on the Initial Setup menu on page 36.
- To see the list of channels found during Channel search, press **INPUT**, and then press ►.

Direct Button Operation

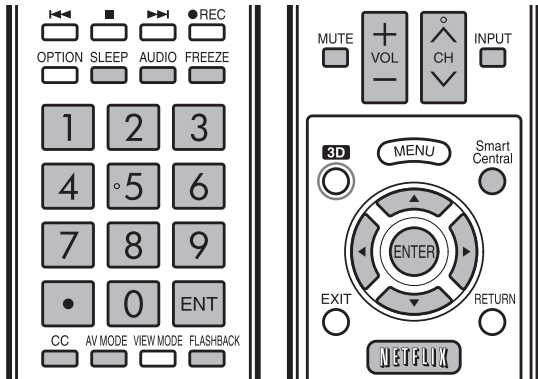

INPUT

To view external source images, select the input source by pressing **INPUT** on the remote control unit or on the TV.

- 1 Press **INPUT**.
 - The INPUT list screen displays.
- 2 Press **▲/▼** or press **INPUT** again to select the input source.
 - An image from the selected source automatically displays.
 - Each time **INPUT** is pressed, the input source toggles.
 - If the corresponding input is not plugged in, you cannot change the input. Be sure to connect the equipment beforehand.

NOTE

- See pages 14 to 18 and 57 for external equipment connection.

Changing Channels

You can change channels in several ways.

Method 1

Using **CH▲/▼** on the remote control unit or on the TV.

Method 2

Using remote control buttons **0-9**, **• (DOT)**.

Examples:

To select a 1 or 2-digit channel number (e. g., Channel 5):
Press **5** → **ENTER**.

To select a 3-digit channel number (e. g., Channel 115):
Press **1** → **1** → **5** → **ENTER**.

To select a 4-digit channel number (e. g., Channel 22.1):
Press **2** → **2** → **• (DOT)** → **1** → **ENTER**.

Method 3

Selecting the program from Channel list.

- 1 Press **INPUT** on the remote control unit.
 - The INPUT list displays.
- 2 Press **◀/▶** to select “AIR” or “CABLE”.
 - The Channel list displays.
- 3 Press **▲/▼** to select the desired channel, and then press **ENTER**.

NOTE

- When selecting a 1-digit channel number, it is not necessary to press **0** before the number.
- When you enter **0-9** only, channel selection will be made if there is no operation within a few seconds.
- If you push “0” by itself, nothing will happen.
- Complete the above steps within a few seconds.
- When you enter **0-9** and **• (DOT)**, channel selection will be made if there is no operation within a few seconds.

Changing Volume

You can change the volume by pressing **VOL +/–** on the TV or on the remote control unit.

- To increase the volume, press **VOL +**.
- To decrease the volume, press **VOL –**.



Audio status

Output device	Output Select	
	Fixed	Variable
Speaker	Variable sound	Mute

- When “Output Select” is set to “Variable”, the indicator on the screen changes as shown below.

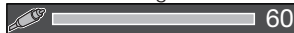

NOTE

- See page 34 for details on the Output Select function.

MUTE

Mutes the current sound output.

Press **MUTE**.

- “” will be displayed on the screen for 30 minutes, and the sound is silenced.

NOTE

- Within 30 minutes of pressing **MUTE**, mute can be canceled by pressing **VOL +/–** or **MUTE**.
- Mute will be canceled after 30 minutes have passed. However, the TV will not suddenly output a loud sound as the volume level is set to 0 automatically.

Sleep Timer

Allows you to set a time when the TV automatically switches to standby.

Press **SLEEP**.

- The remaining time displays when the sleep timer has been set.
- Each time you press **SLEEP**, the remaining time switches as shown below.

Off → 30 → 60 → 90 → 120

- When set, the time automatically starts counting down.
- If you want to adjust the sleep timer, you can press **SLEEP** twice then change the time setting.
- When it is 5 minutes before the time expires, the remaining time will start to keep appearing every minute.

NOTE

- Select “Off” by pressing **SLEEP** to cancel the sleep timer.
- The TV will enter standby when the remaining time reaches 0.

FREEZE

Allows you to capture and freeze a moving image that you are watching.

Press **FREEZE**.

- A moving image is captured.
- Press **FREEZE** again to cancel the function.

NOTE

- When this function is not available, “No displaying still image available.” will display.
- The still image automatically goes out after 30 minutes.
- If you are using the freeze function and a broadcast activates the V-CHIP BLOCK, the freeze function will be canceled and a V-CHIP BLOCK message will appear.
- You can have the same settings by choosing “Freeze” on the menu items. (See page 33.)

Direct Button Operation

FLASHBACK

Press **FLASHBACK** to switch to the previously tuned channel or previous input mode.

- Press **FLASHBACK** again to switch back to the currently tuned channel.

NOTE

- FLASHBACK** will not work if no channel has been changed after the TV is turned on.

SmartCentral

Allows you to directly activate various types of applications.

- Press **SmartCentral** to display the application window.

- Press **SmartCentral** again to display a list of applications by category.

- Press ◀/▶ (or ▲/▼) to select the desired application, and then press **ENTER**.

- If you changed the display to the list of applications in step 1, select a category and then an application. See page 72 for details.
- If "USB" is displayed after you switch to USB mode, check the USB connection.
- If "Internet" or "DLNA" is displayed after you switch to Home Network (DLNA) mode or after you connect to the Internet, check your TV's network settings and connection.

NOTE

- See pages 49, 68 and 72 for details of viewable applications.
- You can display the application window by choosing "APPS" on the menu items. (See page 33.)
- When this function is not available, "Can not operate this function now" will display.

NETFLIX

Displays the Netflix screen.

Press **NETFLIX**.

NOTE

- To enjoy Netflix, you need to make:
 - a broadband Internet connection (See page 66.)
 - settings of Internet Setup (See pages 67 and 68.)
 - adjustments for Netflix (See page 72.)

AV MODE

AV MODE gives you several viewing options to choose from to best match the surrounding environment of the TV, which can vary due to factors like room brightness, type of program watched or the type of image input from external equipment.

Press **AV MODE**. Current AV MODE displays.

- Press **AV MODE** again before the mode displayed on the screen disappears. The mode changes as shown below:

Example:

When the input source is **TV, COMPONENT, VIDEO 1 or 2**

AUTO → STANDARD → MOVIE → GAME → PC
 ↑ ↓
 DYNAMIC (Fixed) ← DYNAMIC ← USER [TV]

Example:

When the input source is **PC IN or HDMI 1 to 4**

AUTO → STANDARD → MOVIE → GAME → PC
 ↑ ↓
 DYNAMIC (Fixed) ← DYNAMIC ← x.v.Color* ← USER []

- * "x.v.Color" can only be selected when an x.v.Color signal is input using HDMI 1 to 4.

AUTO: Optimizes the image quality automatically based on the room brightness and image signal.

STANDARD: For a highly defined image in a normal lighting.

MOVIE: For a movie.

GAME: Lowers image brightness for easier viewing.

PC: For PC.

USER: Allows the user to customize settings as desired. You can set the mode for each input source.

x.v.Color: Supports the x.v.Color international standard for wide color space. The x.v.Color signal allows you to experience colors that conventional color signals cannot reproduce.

DYNAMIC: For a clear-cut image emphasizing high contrast, useful for sports viewing.

DYNAMIC (Fixed): Changes the image and sound settings to the factory preset values. No adjustments are allowed.

NOTE

- You can select a different AV MODE item for each input mode. (For example, select STANDARD for TV input and DYNAMIC for COMPONENT.)
- When you play games, "GAME" is recommended for AV MODE.
- You cannot set "GAME" or "PC" when the TV is connected to the Internet or when the input source is "Home Network (DLNA)" or "USB".
- You can have the same settings by choosing "AV MODE" on the menu items. (See page 29.)

AUDIO

■ MTS/SAP stereo mode

The TV has a feature that allows reception of sound other than the main audio for the program. This feature is called Multi-channel Television Sound (MTS). The TV with MTS can receive mono sound, stereo sound and Secondary Audio Programs (SAP). The SAP feature allows a TV station to broadcast other information, which could be audio in another language or something completely different like weather information.

You can enjoy Hi-Fi stereo sound or SAP broadcasts where available.

- Stereo broadcasts:** View programs like live sporting events, shows and concerts in dynamic stereo sound.
- SAP broadcasts:** Receive TV broadcasts in either MAIN or SAP sound.
 - MAIN sound: The normal program soundtrack (either in mono or stereo).
 - SAP sound: Listen to a second language, supplementary commentary or other information. (SAP is mono sound.)

Direct Button Operation

If stereo sound is difficult to hear.

- Obtain a clearer sound by manually switching to fixed mono-sound mode.

You can change MTS as shown below to match the television broadcast signal.

Press **AUDIO** to toggle between audio modes.

Examples: when receiving MTS and SAP

STEREO mode: STEREO ↔ MONO
 STEREO + SAP mode: ST(SAP) → SAP(ST) → MONO
 MAIN + SAP mode: MAIN ↔ SAP
 MONO mode: MONO

■ Digital broadcasting audio mode

The types of audio transmitted in a digital broadcast include SURROUND as well as MONO and STEREO. In addition, it is possible for multiple audio tracks to accompany a single video track.

Press **ENTER** to toggle between audio modes.

Example: when receiving Digital broadcasting

STEREO (Audio1) → STEREO (Audio2)
 ← SURROUND (Audio3) ←

NOTE

- MTS only operates while in TV mode.
- You can have the same settings by choosing "Change Audio" on the menu items. (See page 33.)

Closed Captions and Digital Closed Captions

Your TV is equipped with an internal Closed Caption decoder. It allows you to view conversations, narration and sound effects as subtitles on your TV. Closed Captions are available on some TV programs and on some VHS home video tapes at the discretion of the program provider.

Digital Closed Caption service is a new caption service available only on digital TV programs (also at the discretion of the service provider). It is a more flexible system than the original Closed Caption system, because it allows for a variety of caption sizes and font styles. When the Digital Closed Caption service is in use, it will be indicated by the appearance of a 3-letter abbreviation that also indicates the language of the Digital Closed Captions: ENG (English), SPA (Spanish), FRA (French) or other language codes.

Not all programs and VHS videotapes offer closed captions. Please look for the "CC" symbol to ensure that captions will be shown.

In the Closed Caption system, there can be more than one caption service provided. Each is identified by its own number. The "CC1" and "CC2" services display subtitles of TV programs superimposed over the program's picture.

In the Closed Caption system, the "Text1" or "Text2" services display text that is unrelated to the program being viewed (e.g., weather or news). These services are also superimposed over the program currently being viewed.

1 Press **CC**.

- This will present the Closed Caption information display.

2 Press **CC** while the Closed Caption information is still on the screen.

- Press repeatedly until you select the desired closed caption service.

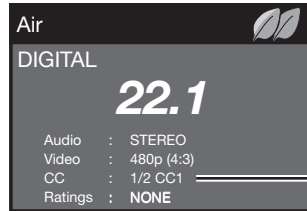

- Depending on the number of caption services in the signal being received, you will see information such as 1/2 or 1/4 displayed. 1/2 means "the first of two services".

Example:

If a program has three services (Digital CC(ENG), CC1 and Text1), the closed caption display will toggle in this sequence:



- The **CC** button keeps a record of the last service selected in its memory. If the last closed caption mode (e.g. 1/3 ENG) you selected is not available for the next program, or on another channel, the closed caption service that is available is automatically selected, and this service appears in parentheses, e.g. "1/3(CC1)". Closed Caption services that appear in parentheses will not be stored in the **CC** button's memory as your last selected service. Only services that you have selected with the **CC** button are stored.

Examples:

In a case where there are two closed caption services provided (for instance, Digital CC(ENG) and CC1), and Digital CC(ENG) is displayed as your current selection, if Digital CC(ENG) is not broadcast for the next program, the other closed caption service, CC1, will be displayed in parentheses.

A closed caption service appears in parentheses because the service you selected is not available and a different service is displayed on your screen. "1/1(CC1)" is displayed instead of "1/2/ENG".

NOTE

- When "Power Saving" is set to "Standard" or "Advanced", the Power Saving leaf icon appears on the channel information window. See page 32 for details of Power Saving settings.
- See page 34 for detailed closed caption settings.
- When the program contains no closed caption, "--" displays in the closed caption information.
- If the language code, e.g. "ENG", is not found on Digital TV programs, "--" will be shown.
- Four kinds of closed caption service (CC1, CC2, Text1, Text2) are potentially available, but a broadcast may contain none or only some of these services at the discretion of the program provider.
- When a web page is displayed, Closed Captions are not available.
- You can have the same settings by choosing "Change CC" on the menu items. (See page 33.)

Direct Button Operation

VIEW MODE

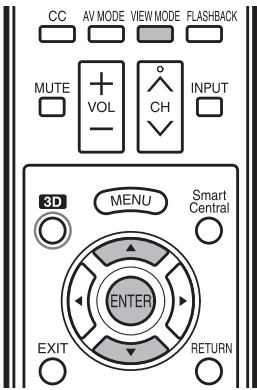

You can select the screen size.

1 Press **VIEW MODE**.

- The View Mode menu displays.
- The menu lists the View Mode options selectable for the type of video signal currently being received.

2 Press **VIEW MODE** or **▲/▼** while the View Mode menu is displayed to select a desired item on the menu.

- You can sequentially select a View Mode that has its own aspect ratio.

NOTE

- You can have the same settings by choosing "View Mode" on the menu items. (See page 33.)
- You may not be able to change the View Mode while in 3D mode.

■ For HD programs

Stretch	Dot by Dot (Full Screen)	S.Stretch (Smart stretch)	Zoom
<p>Suitable for viewing wide-screen 1.78:1 aspect ratio program, stretch mode will still show very thin black bands at the top and bottom of the screen.</p>	<p>Dot by Dot (1080i/p only): Detects the resolution of the signal and displays an image with the same number of pixels on the screen. Full Screen (720p only): You can select "Full Screen" only when receiving a 720p signal.</p>	<p>Suitable for stretching 4:3 programs to fill the screen.</p>	<p>Suitable for viewing wide-screen 2.35:1 aspect-ratio programs in full screen.</p>

NOTE

- When using Dot by Dot or Full Screen, it is possible to see noise or bars around different outer portions of the screen. Please change view mode to correct this.

■ For 4:3 programs

Example: Screen size images

Side Bar	S.Stretch (Smart stretch)	Zoom	Stretch
<p>Suitable for viewing conventional 4:3 programs in their normal format.</p>	<p>Suitable for stretching 4:3 programs to fill the screen.</p>	<p>Suitable for viewing wide-screen 2.35:1 anamorphic DVDs in full screen.</p>	<p>This mode is useful for 1.78:1 DVDs. When viewing 1.85:1 DVDs, stretch mode will still show very thin black bands at the top and bottom of the screen.</p>

■ For USB-Video, DLNA-Video or Internet applications

Example: Screen size images

Input signal	Auto	Original
	<p>Keeps the original aspect ratio in a full screen display.</p>	<p>Displays an image by an original size.</p>

On-Screen Display Menu

On-Screen Display Menu Operation

LCFONT embedded

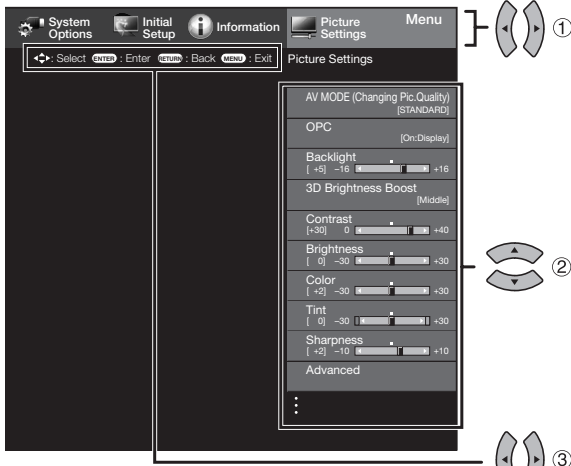

- 1 Press **MENU** to display the MENU screen.
- 2 ① Press **◀/▶** to select the desired menu.
 ② Press **▲/▼** to select a specific adjustment item, and then press **ENTER**.
 - Additional related adjustment items may be displayed. Press **▲/▼** to select the desired item.
- ③ Adjust the item while referring to the guide display.
 - Operations vary depending on the function or item. Refer to the guide display corresponding to the menu setting screen for button operations.
- 3 Press **MENU** to exit.

NOTE

- Menu options differ in the selected input modes, but the operating procedures are the same.
- The screens in the operation manual are for explanation purposes (some are enlarged, others cropped) and may vary slightly from the actual screens.
- The order of explanations for each menu item in the following pages is not necessarily in accordance with the alignment of the items on the screen.

LCFONT:

- This product is embedded with LC Font technology, which was developed by SHARP Corporation for clearly displaying easy-to-read characters on LCD screens.

Menu Operation Buttons

Using the remote control

Use the following buttons on the remote control to operate the menu.

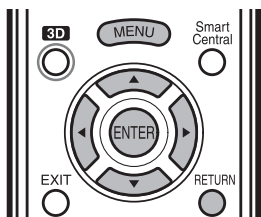

- MENU:** Press to open or close the menu screen.
- ▲/▼/◀/▶:** Press to select a desired item on the screen or adjust a selected item.
- ENTER:** Press to go to the next step or complete the setting.
- RETURN:** Press to return to the previous step.

Using the control panel of the main unit

You can also operate the menu with the control panel of the main unit.

Button operations on the control panel correspond to the ones on the remote control as shown below.

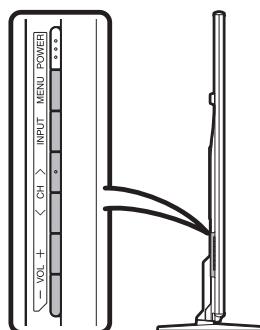

- MENU:** MENU on the remote control.
- INPUT:** ENTER on the remote control.
- CH▲/▼:** Cursor ▲/▼ on the remote control.
- VOL +/–:** Cursor ◀/▶ on the remote control.

Example

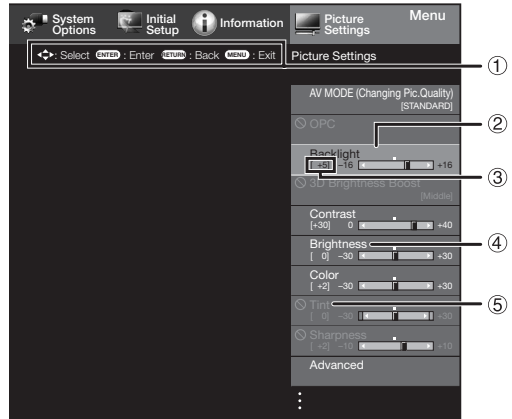

- ① Guide display
 - This indicates the buttons that can be operated on the displayed screen. The guide display varies depending on the menu setting screen.
 - The operations for some selected items may be displayed in the operational guide bar at the bottom of the screen.
- ② Item displayed in blue
 - This indicates the item currently selected.
 - Press **ENTER** to go to the adjustment screen for this item.
- ③ Item in brackets
 - This indicates the current setting for the item.
- ④ Item displayed in white
 - This indicates that the item can be selected.
- ⑤ Item displayed in gray
 - This indicates that the item cannot be selected. There are various reasons why the items cannot be selected, but the main reasons are as follows:
 - Nothing is connected to the selected input terminal.
 - The function is not compatible with the current input signal.

Menu Items

NOTE

- When AV MODE is set to "AUTO", part of the menu may not be displayed correctly or the setting range of the menu may be changed.
- Some menu items may not be displayed depending on the selected input source.

 **Picture Settings**

AV MODE
 (Changing Pic.Quality) Pages 29 and 45
 OPC Page 29
 Backlight Page 29
 3D Brightness Boost Page 45
 Contrast Page 29
 Brightness Page 29
 Color Page 29
 Tint Page 29
 Sharpness Page 29
 Advanced Pages 29-30
 C.M.S.-Hue Page 29
 C.M.S.-Saturation Page 29
 C.M.S.-Value Page 29
 Color Gamut Range Page 30
 Color Temp. Page 30
 Motion Enhancement Page 30
 Active Contrast Page 30
 Gamma Adjustment Page 30
 Black Level Page 30
 Film Mode Page 30
 Digital Noise Reduction Page 30
 Monochrome Page 30
 Range of OPC Page 30
 Reset Page 29

 **Audio Settings**

Auto Volume Page 31
 Treble Page 31
 Bass Page 31
 Balance Page 31
 3D Surround Page 31
 Bass Enhancer Page 31
 Clear Voice Page 31
 Reset Page 31

 **Power Control**

Audio Only Page 32
 Power Saving Page 32
 No Signal Off Page 32
 No Operation Off Page 32

 **System Options**

View Option Pages 33, 53
 APPS Page 33
 USB Operation Panel Page 53
 Home Network (DLNA)
 Operation Panel Page 53
 View Mode Page 33
 Freeze Page 33
 Change Audio Page 33
 Change CC Page 33
 3D Setup Page 46
 AQUOS LINK Setup Page 58

Terminal Setting Pages 33-34, 63
 Audio Setup Page 33
 PC input Page 63
 Audio Select Page 63
 Input Skip Page 34
 Input Label Page 34
 HDMI Setup Page 34
 Output Select Page 34
 Color System Page 34
 Menu Design Page 34
 Channel Selecting Effect Page 34
 Program Title Display Page 34
 Position Page 34
 Caption Setup Page 34
 Game Play Time Page 35
 Operation Lock Out Page 35
 Icon Light Up Setting Page 35
 Demo Mode Page 35

 **Initial Setup**

EZ Setup Page 36
 Language Page 36
 Location & Time Page 36
 TV Location Page 36
 Antenna & Cable/STB Page 36
 Air/Cable Page 36
 CH Search Page 36
 Network Page 36
 Completed Page 36
 Broadcasting Setup Pages 36-37
 CH Setup Page 36
 Favorite CH Page 37
 Antenna Setup-DIGITAL Page 37
 Internet Setup Pages 54, 64, 67-68
 Language Page 37
 DivX® Setup Page 54
 Individual Setup Pages 37-39
 Secret No. Page 37
 Parental CTRL Pages 37-39
 Wall Mount Audio Setup Page 37
 Reset Page 37

 **Information**

Identification Page 40
 Digital Caption Info. Page 40
 Software Update Pages 40-42
 Manual Update Pages 40-42
 Auto Update Setting Page 40
 Netflix Help Page 73
 VUDU Help Page 73

Picture Settings

Adjusts the picture to your preference with the following picture settings.

Example

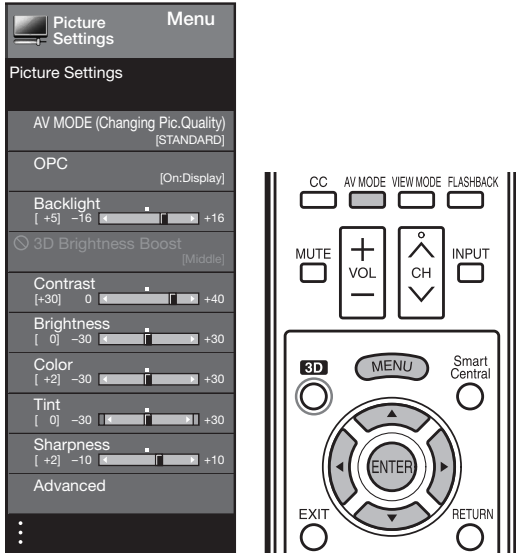

- 1 Press **MENU** to display the MENU screen, and then press **◀/▶** to select "Picture Settings".
- 2 Press **▲/▼** to select a specific adjustment item.
 - Select "Advanced" and then press **ENTER** to set "C.M.S.-Hue", "C.M.S.-Saturation", "C.M.S.-Value", "Color Gamut Range", "Color Temp.", "Motion Enhancement", "Active Contrast", "Gamma Adjustment", "Black Level", "Film Mode", "Digital Noise Reduction", "Monochrome" or "Range of OPC".
- 3 Press **▲/▼**(or **◀/▶**) to select the desired setting, and then press **ENTER**.
- 4 Press **MENU** to exit.

Selected item	◀button	▶button
Backlight	The screen dims	The screen brightens
Contrast	For less contrast	For more contrast
Brightness	For less brightness	For more brightness
Color	For less color intensity	For more color intensity
Tint	Skin tones become reddish	Skin tones become greenish
Sharpness	For less sharpness	For more sharpness

- You can select "3D Brightness Boost" while in 3D mode. (See page 45.)
- For resetting all Picture adjustment items to the factory preset values, press **▲/▼** to select "Reset", press **ENTER**, press **▲/▼** to select "Yes", and then press **ENTER**.

AV MODE (Changing Pic.Quality)

The audio and video settings can be changed to suit the program or input content being watched. Select from the following AV modes.

- **When the input source is TV, COMPONENT, VIDEO 1 or 2:**
 AUTO/STANDARD/MOVIE/GAME/USER/DYNAMIC/DYNAMIC(Fixed)
- **When the input source is PC IN or HDMI 1 to 4:**
 AUTO/STANDARD/MOVIE/GAME/PC/USER/x.v.Color/DYNAMIC/DYNAMIC(Fixed)

NOTE

- The selectable items vary depending on the input source.
- For details of the selectable items in 3D mode, see page 45.
- You can select AV MODE by pressing **AV MODE** on the remote control unit. See page 24 for details of AV MODE settings.

OPC Setting

Automatically adjusts the brightness of the screen.
Off: The brightness is fixed at the value set in "Backlight".
On: Automatically adjusts.
On:Display: Displays the OPC effect on the screen while adjusting the brightness of the screen.

NOTE

- When set to "On", the Optical Picture Control (OPC) senses the surrounding light and automatically adjusts the backlight brightness. Make sure nothing obstructs the OPC sensor, which could affect its ability to sense surrounding light.
- When set to "On:Display", OPC effect displays on the screen while the OPC adjusts the screen brightness.

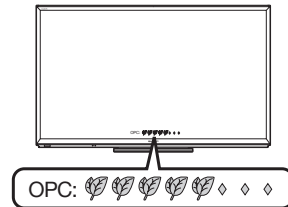

Advanced Picture Settings

This TV provides various advanced functions for optimizing the picture quality.

C.M.S. (Color Management System)

Color tone is managed using the six-color adjustment setting.

- **C.M.S.-Hue:** This is a standard to adjust the color either more reddish or more bluish in tone.
- **C.M.S.-Saturation:** Increases or decreases the saturation of a selected color.
- **C.M.S.-Value:** A higher value makes the image brighter. A lower value makes the image darker.

NOTE

- For resetting all adjustment items to the factory preset values, press **▲/▼** to select "Reset", and then press **ENTER**.

On-Screen Display Menu

Color Gamut Range

You can set the color gamut range.

Standard: Standard color gamut.

Expanded: More vivid colors with expanded color gamut.

NOTE

- "Color Gamut Range" is only available when AV MODE is set to "MOVIE" or "MOVIE (3D)".

Color Temp. (Color Temperature)

For a better white balance, use color temperature correction.

High: White with bluish tone

Mid-High:

Middle:

Mid-Low:

Low: White with reddish tone



White balance can be adjusted between a maximum of +30 and a minimum of -30 for each color temperature.

R Gain (LO/HI)/G Gain (LO/HI)/B Gain (LO/HI)

■ Fine tuning the color temperature

To fine tune the color temperature, set "10 Point Setting" to "On".

You can adjust the "Position" setting. Adjust the set color temperature from +1 to +10.

White balance can be adjusted between a maximum of +30 and a minimum of -30 for each color temperature.

NOTE

- When "Position" is set to "10", you can adjust the white balance between -30 and 0.
- For resetting all adjustment items to the factory preset values, press ▲/▼ to select "Reset", and then press ENTER.

Motion Enhancement

Use Motion Enhancement to view fast-action video more clearly.

240Hz: Turn the LED backlight on or off for 240Hz drive display.

AquoMotion240: Turn the LED backlight on or off for 120Hz drive display.

120Hz High/120Hz Low: For obtaining a clearer image.
Off: Normal image.

NOTE

- "Motion Enhancement" may cause image noise. If this occurs, turn the function "Off".
- When AV MODE is set to "GAME" or "PC", or PC format is being input, "Motion Enhancement" is not available.

Active Contrast

Automatically adjusts the image contrast according to the scene.

On: Automatically adjusts the image contrast.

Off: No adjustment.

Gamma Adjustment

Adjusts the differences of picture tones between bright parts and dark parts. The adjustment range of the gamma can be set to a maximum of +2 and a minimum of -2 by pressing ◀ or ▶.

Black Level

Adjusts on-screen black level to your preferred level.

High: The black level gets brighter.

Low: The black level gets darker.

NOTE

- "Black Level" is available for input signal from Composite Video, Component 480i and analog broadcasts (air and cable).

Film Mode (3:2 pull-down)

Automatically detects a film-based source (originally encoded at 24 frames/second), analyzes it then recreates each still film frame for high-definition picture quality.

Advanced: Adjust effect to reduce judder from film contents. Select a desired level of judder reduction from 0 to +10.

Standard: Detects, analyzes, converts film source.

Off: Normal viewing mode.

NOTE

- "Film Mode" does not function depending on input signal type.
- "Film Mode" does not function when you set AV MODE to "GAME" or "PC".
- "Standard" does not function when channel display shows an input signal resolution of 480p, 720p, or 1080p.

Digital Noise Reduction

Produces a clearer video image.

Auto: Automatically adjusts the level of noise reduction.

High/Middle/Low: Select a desired level for viewing a clearer video image.

Off: No adjustment.

NOTE

- "Digital Noise Reduction" is not available when you set AV MODE to "PC" or PC format is being input.
- When AV MODE is set to "GAME", "Auto" is not available.

Monochrome

For viewing a video in monochrome.

On: For viewing in monochrome.

Off: Normal color.

Range of OPC

The brightness level range of the OPC sensor's automatic adjustments can be set according to your preferences.

The adjustment range of the OPC sensor can be set to a maximum of +16 and a minimum of -16.

Max.: -15 through +16

Min.: -16 through +15

NOTE

- The "Range of OPC" settings are active only when "OPC" is set to "On".
- The maximum setting cannot be set to a smaller number than the minimum setting.
- The minimum setting cannot be set to a bigger number than the maximum setting.
- Depending on the brightness of the surrounding light, the OPC sensor might not operate if the adjustment range is small.

Audio Settings

You can adjust the sound quality to your preference with the following settings.

Example

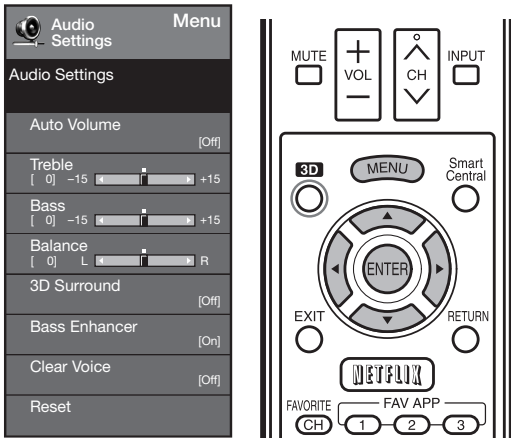

- 1 Press **MENU** to display the MENU screen, and then press **◀/▶** to select "Audio Settings".
- 2 Press **▲/▼** to select a specific adjustment item.
 - Select "Auto Volume", "3D Surround", "Bass Enhancer" or "Clear Voice", and then press **ENTER** to set each item.
- 3 Press **▲/▼** (or **◀/▶**) to select the desired setting, and then press **ENTER**.
- 4 Press **MENU** to exit.

Selected item	◀button	▶button
Treble	For weaker treble	For stronger treble
Bass	For weaker bass	For stronger bass
Balance	Decrease audio from the right speaker	Decrease audio from the left speaker

NOTE

- Audio menu is grayed out when "Output Select" is set to "Variable". (See page 34.)
- For resetting Audio adjustment items to the factory preset values, press **▲/▼** to select "Reset", press **ENTER**, press **▲/▼** to select "Yes", and then press **ENTER**.

Auto Volume

Different sound sources sometimes do not have the same loudness level, such as a program and its commercial breaks. The Automatic Volume Control (Auto Volume) reduces this problem by equalizing levels.

- High:** Reducing the loudness gaps among different sound sources strongly.
- Middle:**
- Low:** Reducing the loudness gaps among different sound sources slightly.

NOTE

- Audio Settings menu is grayed out when "Output Select" is set to "Variable". (See page 34.)

3D Surround

The surround function produces Surround effect from the speakers.

- 3D Stadium:** Reproducing lifelike experience of excitements such that live sports or concert performances in a stadium create.
- 3D Hall:** Reproducing concert hall experience with realistic live surround sound using measured reverberant sound in the concert hall.
- 3D Movie:** Reproducing movie theater experience with realistic live surround sound using measured reverberant sound in the movie theater.
- 3D Standard:** Creating 3 dimensional surround sound with detailed control of the signal phase.
- Normal:** Providing mild surround sound.
- Off:** Outputs the normal sound.

NOTE

- Audio Settings menu is grayed out when "Output Select" is set to "Variable". (See page 34.)
- For some discs, setup may be required on your BD/DVD player. In this case, please refer to the operation manual of your BD/DVD player.

Bass Enhancer

This function allows you to enjoy bass-enhanced sound.

- On:** Bass Enhancer function is on.
- Off:** Normal sound.

NOTE

- Audio Settings menu is grayed out when "Output Select" is set to "Variable". (See page 34.)

Clear Voice

This function emphasizes speech against background noise for greater clarity.

NOTE

- Audio Settings menu is grayed out when "Output Select" is set to "Variable". (See page 34.)

Power Control

Power control setting allows you to save energy.

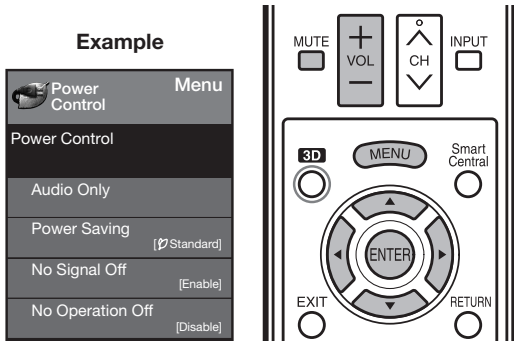

- 1 Press **MENU** to display the MENU screen, and then press **◀▶** to select "Power Control".
- 2 Press **▲/▼** to select a specific adjustment item, and then press **ENTER**.
- 3 Press **▲/▼** (or **◀▶**) to select the desired setting, and then press **ENTER**.
- 4 Press **MENU** to exit.
 - Skip this step for "Audio Only".

Audio Only

When listening to music from a music program, you can turn the screen off and enjoy audio only.

- On:** Audio is output without screen image.
- Off:** Both screen images and audio are output.

NOTE

- The screen image will return to normal when a button (except those for audio adjustment, such as **VOL**, **MUTE**) is pressed.

Power Saving

This function allows you to set the Power Saving level in order to decrease the power consumption and increase the backlight lifespan.

Standard: Optimizes power reduction based upon video content. When set to "Standard", "☁" appears on the screen.

Advanced: Optimizes power reduction based upon video content and engages OPC. When set to "Advanced", "☁" appears on the screen.

Off: This function does not work.

NOTE

- "Power Saving" does not function when you set AV MODE to "AUTO" or "DYNAMIC (Fixed)".
- You cannot select a different Power Saving item for each AV MODE.
 - When "Power Saving" is set, the "OPC" settings for all AV Modes will automatically change.
 - If you set "OPC" to "On" when "Power Saving" is set to "Standard", then the "Power Saving" setting will change to "Advanced".
 - When you change the "Power Saving" setting from "Advanced" to "Off" or to "Standard", "OPC" will be set to "Off".
 - "AUTO" and "DYNAMIC (Fixed)" will remain set to "Off".
- When "Power Saving" is set to "Standard" or "Advanced", the Power Saving leaf icon appears to the left of "OPC" in the Picture Settings menu screen.
- "Power Saving" is not available when the TV is in 3D mode.

No Signal Off

This function allows the TV to automatically shut the power down when there is no signal received.

Enable: The power will automatically shut down if there is no signal for 15 minutes.

Disable: This function does not work.

A confirmation screen appears.

Yes: The setting will be changed.

No: The setting will not be changed.

NOTE

- When it is 5 minutes before the power shuts down, the remaining time will start to keep appearing every minute.
- When a TV program finishes, this function may not operate.

No Operation Off

This function allows the TV to automatically shut the power down when there is no operation.

Enable: The power will automatically shut down if there is no operation for 3 hours.

Disable: This function does not work.

A confirmation screen appears.

Yes: The setting will be changed.

No: The setting will not be changed.

NOTE

- When it is 5 minutes before the power shuts down, the remaining time will start to keep appearing every minute.

System Options

Example

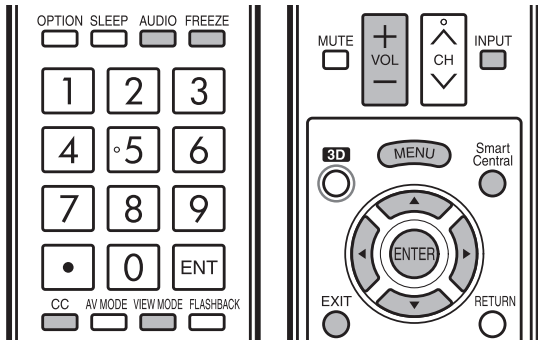
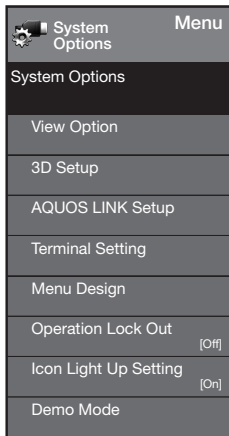

- 1 Press **MENU** to display the MENU screen, and then press **◀▶** to select "System Options".
- 2 Press **▲/▼** to select a specific adjustment item and then press **ENTER**.
- 3 Press **▲/▼** (or **◀▶**) to select the desired setting, and then press **ENTER**.
- 4 Press **MENU** to exit.

View Option

These functions are useful for adjusting the audio and video settings. The View Option functions can be operated with the remote control unit.

APPS

The application window can be displayed by selecting "APPS" on the MENU screen.

NOTE

- You can display the application window by pressing **SmartCentral** on the remote control unit. (See page 24.)

View Mode

This function changes the screen size. Select "View Option" on the menu to display the View Mode menu screen.

The View Mode menu varies depending on the input source.

NOTE

- You can select View Mode by pressing **VIEW MODE** on the remote control unit.
 - See page 26 for adjusting the video being input from a TV, other audiovisual equipment, USB-Video, DLNA-Video or Internet applications.
 - See page 62 for adjusting the video being input from a PC.

Freeze

Allows you to capture and freeze a moving image that you are watching.

NOTE

- You can select Freeze by pressing **FREEZE** on the remote control unit. See page 23 for details of Freeze function.

Change Audio

Allows you to change the audio when multiple audio is available for the program you are watching.

NOTE

- You can change Audio by pressing **AUDIO** on the remote control unit. See pages 24 to 25 for details of Audio function.

Change CC

Allows you to change the Closed Caption display. Select "Change CC" on the menu to display the Closed Caption information.

- The information displayed varies depending on the program you are watching.

NOTE

- You can change Closed Caption by pressing **CC** on the remote control unit. See page 25 for details of Closed Caption function.

Terminal Setting

Audio Setup

You can output digital audio to an AV amplifier or similar device whose DIGITAL AUDIO INPUT terminal is connected to the DIGITAL AUDIO OUTPUT terminal on the TV. Please select an audio output format compatible with the audio format of the program you are watching and the equipment connected.

PCM: Set to "PCM" when connecting to equipment that does not support Dolby Digital. The same audio (main, sub, or main/sub) as the audio of the program being viewed is output.

2-channel audio with a sampling rate of 48 kHz or less is output as linear PCM audio.

Bitstream: Set to "Bitstream" when connecting to an audio system that supports Dolby Digital. Audio is output through both the main and sub channels.

NOTE

- Analog channel audio and video input audio are output in PCM mode even when "Bitstream" is selected.
- PCM digital input signals are output in PCM mode even when "Bitstream" is selected.

On-Screen Display Menu

Input Skip

This setting allows you to skip the TV, HDMI or PC IN Input ("TV", "PC IN", "HDMI 1", "HDMI 2", "HDMI 3" and "HDMI 4") on the Input Selection operation.

Yes: Skips the input.

No: Does not skip input.

Input Label

Lets you set the input terminal displayed when using the INPUT list or channel display. Press ▲/▼/◀/▶ to select the new name for the input mode.

- Using the software keyboard, you can enter up to 10 characters for text. (See page 69.)

NOTE

- You cannot change labels if the input source is TV, Home Network (DLNA) or USB.

HDMI Setup

To watch an HDMI or PC IN equipment image, select "HDMI 1", "HDMI 2", "HDMI 3" or "HDMI 4" from the INPUT list using **INPUT** on the remote control unit or on the TV.

Auto View:

Enable: To use View Mode based on signal recognition, including an HDMI signal.

Disable: No function.

NOTE

- Refer to your external equipment operation manual for the signal type.
- When connecting a DVI-HDMI conversion adapter/cable to the HDMI terminal, the image may not come in clearly.

Output Select

Allows you to select what controls the audio output.

Fixed: Sound via speaker is adjusted with **VOL + / -** on the remote control unit or on the TV.

Sound via the AUDIO OUT terminal is not adjustable and outputs at a consistent level.

Variable: Sound via the AUDIO OUT terminal is adjusted with **VOL + / -** on the remote control unit or on the TV. Sound via speaker is muted.

Color System

Select the video signal system compatible with your equipment from the list below:

Auto/NTSC/PAL-M/PAL-N

NOTE

- "Color System" can only be set for the VIDEO 1 or 2.
- If you have already set the Secret No., input the 4-digit secret number here. See page 37 for setting a secret number.

Menu Design

Channel Selecting Effect

You can select whether to use transition effects when changing channels.

Yes: A transition effect is used when the channel is changed.

No: No function.

NOTE

- In some cases, "Channel Selecting Effect" does not work.

Program Title Display

Select the CH display when changing channels for digital broadcasting.

Yes: "Program Info." displays.

No: "Program Info." does not display.

Position

For adjusting a picture's horizontal and vertical position.

H-Pos.: Centers the image by moving it to the left or right.

V-Pos.: Centers the image by moving it up or down.

NOTE

- For resetting adjustments to the factory preset values, press ▲/▼ to select "Reset", and then press **ENTER**.
- When connecting a PC to the HDMI terminal, the image position will be automatically adjusted. It cannot be manually adjusted.
- The screen position variable ranges depend on the View Mode or the signal type. The ranges can be seen on the position-setting screen.
- Adjustments are stored separately according to input source.
- "Position" does not work when USB mode, Home Network (DLNA) mode or an Internet application is used.
- You may not be able to adjust the position while in 3D mode.

Caption Setup

This function allows you to adjust the closed caption screen appearance to suit your preference. You can adjust 7 items: "Caption Size", "Font Style", "Foreground Color", "Foreground Opacity", "Background Color", "Background Opacity" and "Character Edge".

Example:

Selectable items available for "Font Style".

Default: The font specified by broadcasting station or default font.

Type 0: Proportional font used in the MENU screen.

Type 1: Monospaced with serifs.

Type 2: Proportionally spaced with serifs.

Type 3: Monospaced without serifs.

Type 4: Proportionally spaced without serifs.

Type 5: Casual font type.

Type 6: Cursive font type.

Type 7: Small capitals.

NOTE

- For resetting adjustments to the factory preset values, press ▲/▼ to select "Reset", and then press **ENTER**.
- The default value depends on the broadcasting station.

On-Screen Display Menu

Game Play Time

This function displays the elapsed game time so you do not lose track of the time. To display the elapsed time, select "GAME" for the AV MODE before starting the game.

On: The elapsed time is displayed every 30 minutes when you switch to GAME mode in external input mode.

Off: No adjustment.

Operation Lock Out

This function locks the operation buttons on the TV and the remote control.

Off: No adjustment.

RC Control Lock: All buttons on the remote control are locked.

Button Control Lock: All buttons on the TV, except **POWER**, are locked.

When "RC Control Lock" or "Button Control Lock" is selected, a confirmation screen appears.

Yes: Locks the operation buttons.

No: No adjustment.

NOTE

- To unlock the buttons on the remote control by using the control panel of the main unit (see page 27):
 - Press **MENU** to display the MENU screen, press **VOL + / -** to select "System Options", and then press **INPUT**.
 - Press **CH^/V** to select "Operation Lock Out", and then press **INPUT**.
 - Press **CH^/V** to select "Off", and then press **INPUT**.
 - Press **MENU** to exit.
- To unlock the buttons on the TV, press **MENU** on the remote control, and then select "Off" in "Operation Lock Out".

Icon Light Up Setting

When this function is set to "On", the LED on the front of the TV turns on.

- The LED lights white in 2D mode.
- The LED lights blue in 3D mode.

NOTE

- "On" is the factory preset value. If you want to turn off the LED, set the function to "Off".

Demo Mode

You can select the image from several types of demo mode.

Quattron/240Hz Panel/SmartCentral/3D/Feature Demo/Auto Play

If you have selected "Auto Play", you need to select the desired playback type(s), and then set the playback time.

Continuous: Play Demos continuously.

10 min.: Play Demos every 10 minutes.

20 min.: Play Demos every 20 minutes.

NOTE

- This function will be canceled when you press **EXIT** on the remote control unit.
- When "Demo Mode" is set to "Quattron" or "Feature Demo", pressing **FREEZE** pauses/restarts demo.
- "Demo Mode" may not be selected depending on input signal type or application status.
- "Demo Mode" may be automatically canceled depending on input signal type.

Initial Setup

Example

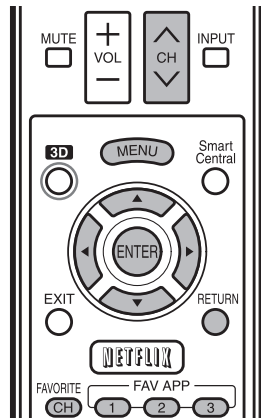
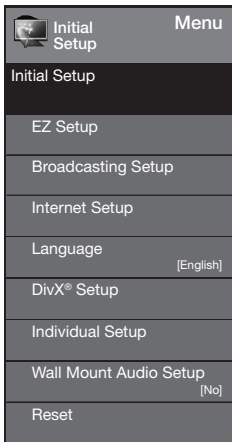

- 1 Press **MENU** to display the MENU screen, and then press **◀▶** to select "Initial Setup".
- 2 Press **▲/▼** to select a specific adjustment item, and then press **ENTER**.
 - When you select "EZ Setup", "CH Setup", "Parental CTRL" or "Reset", you can enter the 4-digit secret number here. See page 37 for setting a secret number.
- 3 Press **▲/▼** (or **◀▶**) to select the desired setting, and then press **ENTER**.
- 4 Press **MENU** to exit.

EZ Setup

You can run EZ Setup again, even after setting up the preset channels.

- Language:** Select from among 3 languages (English, French and Spanish).
- Location & Time:** Make settings for the country, area and time zone where you use the TV.
 - Select your country:** Select either "United States", "Canada" or "Mexico".
 - Select your time zone:** Select your time zone. The available settings differ depending on the selected country.
 - Select DST (Daylight Savings Time):** Select "Auto", "Manual" or "Off".
- TV Location:** Select "Home" or "Store" for the location where you plan to install the TV. This product qualifies for ENERGY STAR in Home mode default setting.
 - Home:** "Power Saving" is set to "Advanced", and AV MODE is set to "STANDARD".
 - Store:** "Power Saving" is set to "Off" and AV MODE is set to "DYNAMIC (Fixed)". Picture Reset and Feature Demo can be set.
 - Picture Reset:** AV MODE will be set to "DYNAMIC (Fixed)" regardless of whether Picture Reset is "On" or "Off". If you select "On", AV MODE will be reset to "DYNAMIC (Fixed)" if there is no operation for 30 minutes. When "Off" is selected, AV MODE will be set to "DYNAMIC (Fixed)".
 - Feature Demo:** When "On" is selected, after all the settings are completed, the Feature Demo screen is displayed if there is no operation for several minutes.
- ENERGY STAR qualification is based on AV MODE "STANDARD".

Antenna & Cable/STB: Select the type of connection you will use to watch TV.

Air/Cable: Make sure what kind of connection is made with your TV when selecting "Air" or "Cable".

CH Search: Channel auto search makes the TV look for all channels viewable in the set area.

- If "Cable" is selected for Antenna setting, scrambled channels are removed after the Channel search has been completed.

Network: When you connect to the Internet on the TV, confirm the connection method and make adjustments.

- Wireless LAN connection is possible only when the WPS (push button) method is used. If any other method is used, make settings by Initial Setup > Internet Setup > Network Setup. (See page 67.)

Completed: The settings confirmation screen is displayed. Confirm the information displayed on the screen.

NOTE

- See Initial Installation on pages 19 to 22 for setting each item.
- If no channel is found, confirm the type of connection made with your TV and try "EZ Setup" again.
- If you select "Analog Search Start" and initiate the channel search, the CH Memory for Cable Digital will be deleted.

Broadcasting Setup

CH Setup

If Initial Installation does not memorize all the channels in your region, follow the instructions below to manually memorize the channels.

Air/Cable: Make sure what kind of connection is made with your TV when selecting "Air" or "Cable".

CH Search: Channel auto search makes the TV look for all channels viewable in the set area.

CH Memory: You can select the channels to skip in each ANALOG (Air), ANALOG (Cable), DIGITAL (Air) and DIGITAL (Cable).

On: Skips channels. (Channel selection disabled using **CH ▲/▼**.)

Off: Does not skip channels. (Channel selection enabled using **CH ▲/▼**.)

Remove Scrambled CH: This function makes the TV look for and then delete digital cable channels that are scrambled and so unavailable in the set area. The process may take more than 20 minutes.

Yes: Starts to remove scrambled channels.

No: This function does not work.

NOTE

- See Initial Installation on pages 19 to 22 for setting each item.
- If no channel is found, confirm the type of connection made with your TV and try channel search again.
- If you select "Analog Search Start" and initiate the channel search, the CH Memory for Cable Digital will be deleted.

On-Screen Display Menu

Favorite CH (Favorite Channel Setting)

This function allows you to program 4 favorite channels, in 4 different categories. By setting the favorite channels in advance, you can select your favorite channels easily.

To register your favorite channel:

Select "Register" and then press **ENTER**. Press ▲/▼/◀/▶ to select the position in the category, and then press **ENTER** to register.

To delete your favorite channel:

Select "1 Data Clear" and then press **ENTER**. Press ▲/▼/◀/▶ to select the channel you want to delete, and then press **ENTER**. Select "Yes" and then press **ENTER**.

To delete all the favorite channels, select "All Data Clear".

NOTE

- Before setting the channel, select the channel you want to register as a favorite channel.
- You can display the "Favorite CH" screen by pressing **FAVORITE CH** on the remote control.

Antenna Setup-DIGITAL

In order to receive digital air broadcasts, you need a digital broadcast antenna. You can confirm the antenna configuration through the "Antenna Setup-DIGITAL" screen. If necessary, adjust the direction of the antenna to obtain the maximum signal strength.

Signal Strength: The signal strength of DIGITAL channel is displayed. The signal information is based on the current channel.

Channel Strength: Input the 2-digit channel number to check the signal strength of the selected channel. Make sure the signal is strong enough for each channel.

- This function is available for DIGITAL (Air) only.

Language

You can also select a language from the Initial Setup menu. Select from among 3 languages: English, French and Spanish.

Wall Mount Audio Setup

This selects the optimal audio for the program you are currently watching even when the TV is mounted to a wall.

Yes: Selects the optimal audio.

No: No adjustment.

Reset

If complex adjustments are made and the settings cannot be restored to normal, you can reset the settings to the factory preset values.

- If you have already set the Secret No., input the 4-digit secret number here.

NOTE

- The Channel Setup settings will not be changed.
- The Language settings will not be changed.
- The Secret number settings will not be changed.
- The TV Location settings will not be changed.

Individual Setup

Secret No.

Allows you to use a secret number to protect certain settings from being accidentally changed.

IMPORTANT:

Three conditions must be met to enable the V-Chip (see pages 38 to 39):

1. Secret No. is registered.
2. V-Chip/V-Chip (DTV Only) settings have been made.
 - The "V-Chip (DTV Only)" will only be selectable when a new rating system can be downloaded via digital broadcasting in the U.S.
3. "Status" is set to "On".

■ Setting the Secret No.

You can set and change the secret number by using **0-9**.

Yes: Changes or sets the Secret No.

No: The confirmation screen to clear the Secret No. appears when the Secret No. has been set. When the Secret No. has not been set, the previous screen will be displayed.

■ Secret No. Clear

You can clear your secret number.

Yes: Your secret number is cleared.

No: Your secret number is not cleared.

NOTE

- As a precautionary measure, make a note of your secret number and keep it in a familiar place.
- If the secret number is cleared, the Status setting automatically sets to "Off". "V-Chip" and "Status" will not be selectable from the menu.

Parental CTRL (Parental Control Setting)

Status

Used to enable or disable the parental control function. This function will not be selectable from the menu if you do not first configure your secret number.

On: Enables Parental CTRL.

Off: Disables Parental CTRL.

On-Screen Display Menu

V-Chip

V-CHIP is an electronic filtering device built into your TV. This tool gives parents a great degree of control over broadcasts accessed by their children. It allows parents to select programs judged suitable for child viewing while blocking ones judged not suitable. It does so automatically once you activate the V-CHIP feature in your TV. "V-Chip" and "Status" will not be selectable from the menu if you do not first configure your secret number.

- The U.S. has two rating systems for viewing content: TV Parental Guidelines and movie ratings.
- The TV Parental Guidelines work in conjunction with the V-CHIP to help parents screen out inappropriate television shows from their children.
- Movie ratings are used for original movies rated by the Motion Picture Association of America (MPAA) as watched on cable TV and not edited for television. The V-CHIP can also be set to block MPAA-rated movies.

NOTE

- The setting automatically enters "Block" for any ratings below your selection.
- If Status is not set to "On", the configuration settings will not work.

MPAA (Voluntary movie rating system)

Example

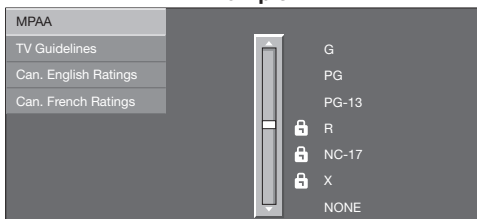

Press ▲/▼ to adjust the item to your desired position. "🔒" indicates the item is blocked. Press **MENU** to exit.

- G:** General audiences. All ages admitted.
- PG:** Parental guidance suggested. Some material may not be suitable for children.
- PG-13:** Parents strongly cautioned. Some material may be inappropriate for children under 13.
- R:** Restricted. Under 17 requires accompanying parent or adult guardian (age varies in some jurisdictions).
- NC-17:** No one 17 and under admitted.
- X:** X is an older rating that is unified with NC-17 but may be encoded in the data of older movies.

NOTE

- Voluntary movie rating system only uses an age-based rating.

TV Parental Guidelines

Example

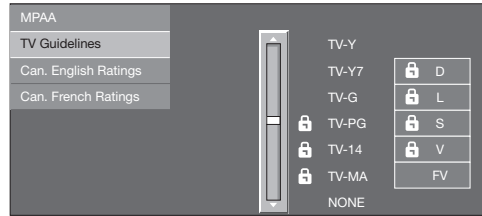

Press ▲/▼ to adjust the item to your desired position. "🔒" indicates the item is blocked. Press **MENU** to exit.

Suggested age

- TV-Y:** All children.
- TV-Y7:** Directed to older children.
- TV-G:** General audience.
- TV-PG:** Parental Guidance suggested.
- TV-14:** Parents strongly cautioned.
- TV-MA:** Mature audience only.

Example

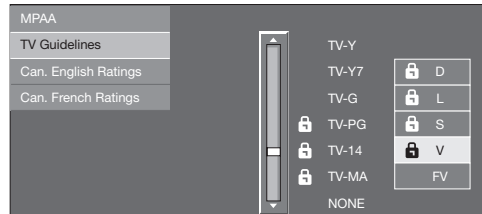

When setting an individual content-based rating item:

- 1 Press ► or **ENTER** to access blocked content items from the currently selected age-based rating item.
- 2 Press ▲/▼ to select an individual item, and then press **ENTER** to unblock it ("🔒" is removed). Repeat the same steps for the other items.
- 3 Press ◀ or **RETURN** to register after all individual content rating items are set.

Content

- FV:** Fantasy violence.
- V:** Violence.
- S:** Sexual situation.
- L:** Adult language.
- D:** Sexually suggestive dialog.

Rating		Content				
		FV	V	S	L	D
Suggested age	TV-Y	☒	☒	☒	☒	☒
	TV-Y7	×	☒	☒	☒	☒
	TV-G		☒	☒	☒	☒
	TV-PG		×	×	×	×
	TV-14		×	×	×	×
	TV-MA		×	×	×	

☒ : The content rating can be set, but this rating is not normally broadcast by TV stations.

× : Content rating can be set.

On-Screen Display Menu

Canadian Rating Systems (Canadian English ratings and Canadian French ratings)

- The TV rating systems in Canada are based on the Canadian Radio-Television and Telecommunications Commission (CRTC) policy on violence in television programming.
- While violence is the most important content element to be rated, the structure developed takes into consideration other program content like language, nudity, sexuality and mature themes.
- When setting the V-CHIP on the Canadian system you can choose either the Canadian English ratings or the Canadian French ratings.

Canadian English Ratings

Example

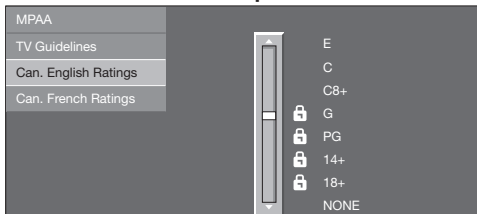

Press ▲/▼ to adjust the item to your desired position. "🔒" indicates the item is blocked. Press **MENU** to exit.

- E:** Exempt: Includes news, sports, documentaries and other information programming; talk shows, music videos, and variety programming.
- C:** Children: Intended for younger children under the age of 8 years. Pays careful attention to themes that could threaten their sense of security and well-being.
- C8+:** Children over 8 years old: Contains no portrayal of violence as the preferred, acceptable, or only way to resolve conflict; nor encourage children to imitate dangerous acts which they may see on the screen.
- G:** General: Considered acceptable for all age groups. Appropriate viewing for the entire family, contains very little violence, physical, verbal or emotional.
- PG:** Parental Guidance: Intended for a general audience, but may not be suitable for younger children (under the age of 8) because it could contain controversial themes or issues.
- 14+:** Over 14 years: Could contain themes where violence is one of the dominant elements of the storyline, but it must be integral to the development of plot or character. Language usage could be profane and nudity present within the context of the theme.
- 18+:** Adults: Intended for viewers 18 years and older and might contain depictions of violence, which while related to the development of plot, character or themes, are intended for adult viewing. Could contain graphic language and portrayals of sex and nudity.

Canadian French Ratings

Example

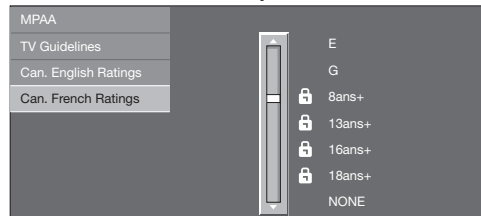

Press ▲/▼ to adjust the item to your desired position. "🔒" indicates the item is blocked. Press **MENU** to exit.

- E:** Exempt programming.
- G:** General: All ages and children, contains minimal direct violence, but may be integrated into the plot in a humorous or unrealistic manner.
- 8ans+:** General but inadvisable for young children: May be viewed by a wide public audience, but could contain scenes disturbing to children under 8 who cannot distinguish between imaginary and real situations. Recommended for viewing with parent.
- 13ans+:** Over 13 years: Could contain scenes of frequent violent scenes and therefore recommended for viewing with parent.
- 16ans+:** Over 16 years: Could contain frequent violent scenes and intense violence.
- 18ans+:** Over 18 years: Only for adult viewing. Could contain frequent violent scenes and extreme violence.

How to temporarily release the V-CHIP BLOCK

When the V-CHIP BLOCK is working and censors a broadcast, "V-CHIP HAS BEEN ACTIVATED." displays.

- 1 Press **ENTER** while the V-CHIP is working, and then the secret number setting menu displays.
- 2 Input the 4-digit secret number by using **0-9**. At this time V-CHIP BLOCK temporarily releases.

Reactivating the temporarily released V-CHIP BLOCK

You can reactivate the temporarily released V-CHIP BLOCK as shown below.

- Select "Status" setting from the Parental CTRL menu to reactivate BLOCK. (See page 37.)
- Select "V-Chip" setting ("MPAA", "TV Guidelines", "Can. English Ratings" or "Can. French Ratings") from the Parental CTRL to reactivate BLOCK. (See pages 38 to 39.)
- Switch off the TV power.

NOTE

- Performing any of the three above will activate the V-CHIP BLOCK.

Information

Example

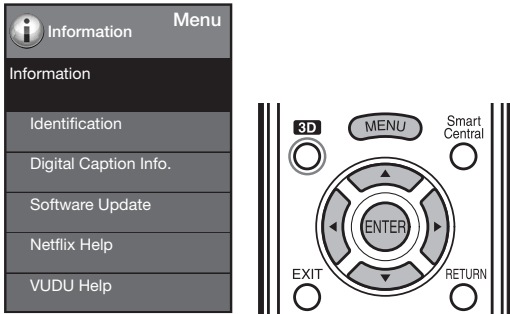

- 1 Press **MENU** to display the MENU screen, and then press **◀/▶** to select "Information".
- 2 Press **▲/▼** to select a specific adjustment item, and then press **ENTER**.
- 3 Press **▲/▼** (or **◀/▶**) to select the desired setting, and then press **ENTER**.
- 4 Press **MENU** to exit.

Identification

The current version of the TV software is displayed.

Digital Caption Info.
(Digital Caption Information)

This function allows viewing of digital closed caption information for the digital broadcast program being viewed.

NOTE

- This list is not displayed for analog broadcasts or external input audio/video.
- This information is not included in CC1, CC2, Text1, or Text2, and is not displayed in a list.

Software Update

This is used to upgrade the system software to enhance the TV functions.

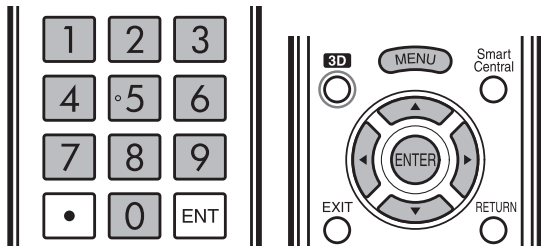

- 1 Press **MENU** to display MENU screen, and then press **◀/▶** to select "Information".

- 2 Press **▲/▼** to select "Software Update", and then press **ENTER**.
 - If you have already set the Secret No., go to step 3.

Example

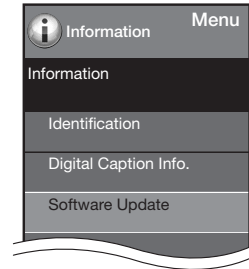

- 3 Input the 4-digit secret number by using **0-9**.

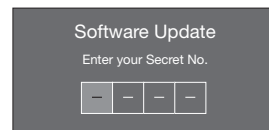

- 4 Press **▲/▼** to select "Manual Update" or "Auto Update Setting", and then press **ENTER**.
 - The operations thereafter vary depending on the setting.

Manual Update

Select the method for manually updating the software.

- USB Update:** Updates the software using a USB memory device containing the update file. (See pages 41 to 42.)
- Network Update:** Downloads the update file via the network and then updates the software. (See page 41.)

NOTE

- A broadband connection and Internet Setup are required to update the software using the network. (See pages 66 to 68.)
- It may take time to access and download the update depending on the Internet connection and other factors.

Auto Update Setting

When the TV is on, or when an Internet application is being accessed, this function enables the TV to connect to the network and check for updates automatically.

- Yes:** Enables Auto Update Setting.
- No:** Disables Auto Update Setting.

When an update is available, a message is displayed. Press **◀/▶** to select "Yes", and then press **ENTER** to display the download screen. (See page 41.)

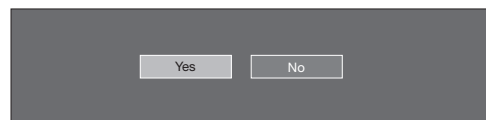

NOTE

- This function does not work when a broadband connection or Internet Setup is not available.
- A message may also be displayed when an application is running. The message varies depending on the application.

On-Screen Display Menu

■ Updating the Software via the Network

- 1 Press ▲/▼ on the Manual Update screen to select "Network Update", and then press **ENTER**.
 - The TV connects to the network and checks for updates.
 - To cancel, press **ENTER**.

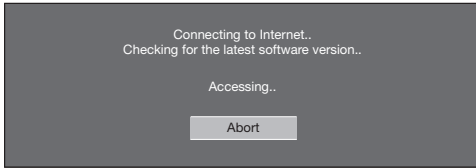

- 2 The current version of the TV and the latest version of software are displayed. To update the TV software, select "Yes", and then press **ENTER**.

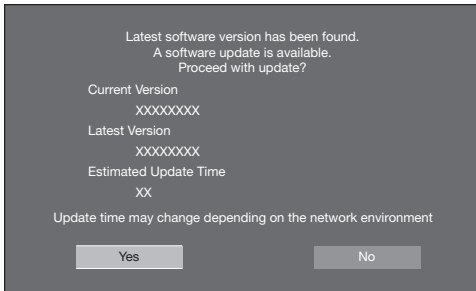

- When a server connection cannot be established or an update is not available, a message is displayed. If a server connection cannot be established, check the broadband connection and Internet Setup.

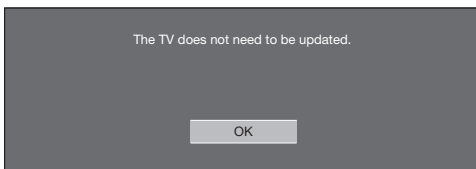
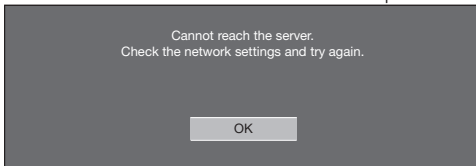

- 3 After the update file is downloaded, the software update process begins.

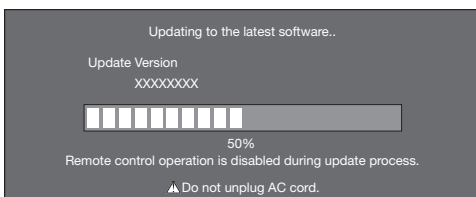
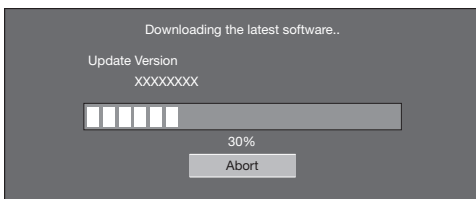

CAUTION

- **Do not unplug the AC cord while the software is being updated.**
- 4 When the software is successfully updated, a screen is displayed indicating that the update process is completed. A screen indicating that the update is completed is displayed. 4 seconds later, the TV restarts automatically.

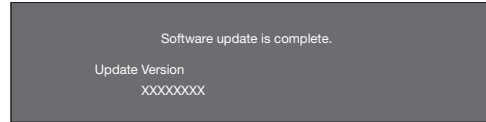

- If the software was not updated successfully, check the broadband connection and Internet Setup, and then try updating the software again.

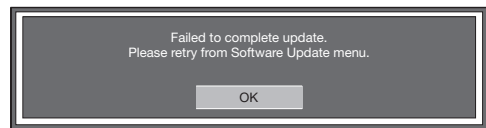

■ Updating the Software with a USB Memory Device

To check for the availability of a software update, visit <http://www.sharpsusa.com/products/support/>. If you have any questions, please call 1-800-BE-SHARP (800-237-4277).

CAUTION

- **Do not remove the USB memory device or unplug the AC cord while the software is being updated.**
- **Be sure to properly follow the whole procedure described below, step by step. Otherwise, for example, the TV cannot read the data in the USB memory device and software updating will fail.**

- 1 Insert the USB memory device with the update file into the USB 1 or USB 2 terminal on the TV.
 - When you update the software, use only one USB terminal. Either USB 1 or USB 2 is usable.

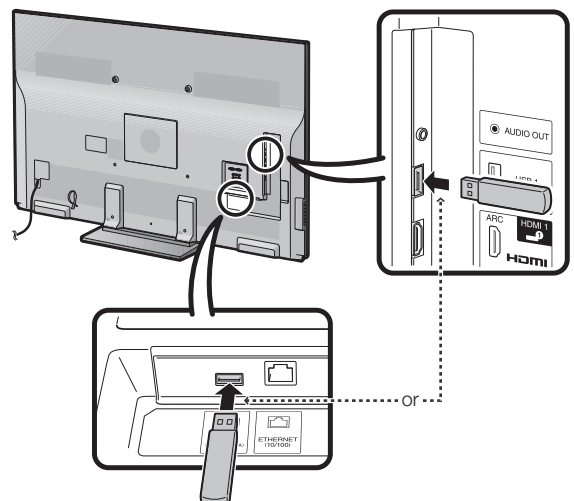

- 2 Press ▲/▼ on the Manual Update screen to select "USB Update", and then press **ENTER**.

On-Screen Display Menu

- 3 Press **ENTER** to start checking the data in the USB memory device.



- 4 During the data checking, "Checking" blinks.

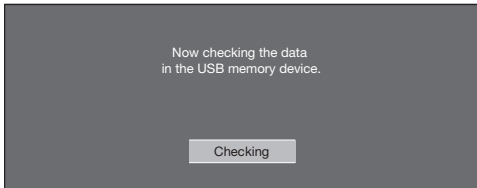

- The current version of the TV software and the version of the update file on the USB memory device are displayed.

Example



- If the USB memory device is not properly installed or the correct update file cannot be found on the USB memory device, an error message is displayed. Check the file on the USB memory device, and then reinsert the USB memory device correctly.

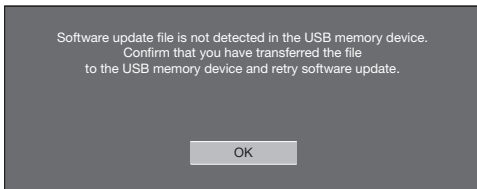

- 5 To update the TV software with the update file, select "Yes", and then press **ENTER**.

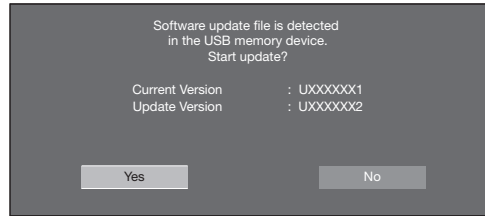

Example

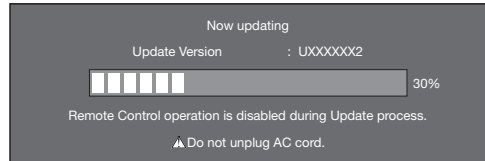

CAUTION

- Do not remove the USB memory device or unplug the AC cord while the software is being updated.**

- 6 When the software is successfully updated, a screen is displayed indicating that the update process is completed. After this screen is displayed, the TV automatically turns off and then turns on again.

Example

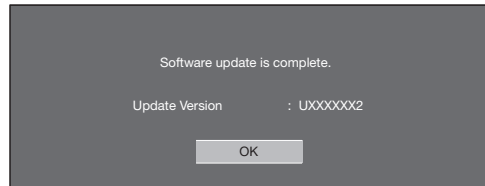

- If the update has failed, check the file in the USB memory device and try Software Update again.

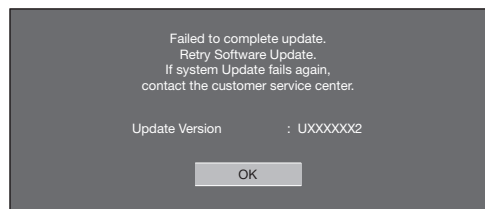

- 7 After the screen shown below is displayed, press **ENTER**.



- 8 Remove the USB memory device.

Enjoying 3D Image Viewing





You can use special 3D Glasses to watch 3D-supported images on this TV.

- You can enjoy 3D movies on this TV by viewing the movie through SHARP 3D Glasses sold separately.
- To produce 3D images, liquid crystal shutters in the 3D Glasses alternately open and close imperceptibly fast to exactly match alternating left and right video images displayed by the TV.
- Not all consumers can experience and enjoy 3DTV. Some people suffer from stereo blindness which prevents them from perceiving the intended depth of 3D entertainment. Also, some people who watch 3D programming may experience initial feelings of motion sickness as they adjust to the picture. Others may experience headaches, eye fatigue or motion sickness. Some viewers might also experience epileptic seizures. Like a roller coaster, the experience is not for everyone.

CAUTION

- **The 3D Glasses are precision equipment. Handle them with care.**
- **Improper use of the 3D Glasses or failure to follow these instructions can result in eye strain.**
- **If you experience dizziness, nausea, or other discomfort while viewing 3D images, immediately discontinue use of the 3D Glasses. Using the 3DTV with incompatible 3D broadcasts or software can make images appear blurry or create overlapping images.**
- **When viewing 3D images continuously, be sure to take a break periodically to prevent eye strain.**
- **If you are nearsighted or farsighted or have astigmatism or a different level of eyesight between the left and right eyes, you should take the necessary steps, such as wearing eyeglasses, to correct your eyesight before viewing 3D images. The 3D Glasses can be worn over eyeglasses.**
- **When viewing 3D images, keep the 3D Glasses horizontally level with the TV screen. If you tilt the 3D Glasses with respect to the TV screen, the images viewed by the left and right eyes may appear significantly different or images may appear overlapping.**
- **View 3D images at the appropriate distance from the TV screen. The recommended distance is three times the effective height of the TV screen.**
Examples of recommended distances
 70-inch screen: Approx. 8.5 ft (2.6 m)
 60-inch screen: Approx. 7.2 ft (2.2 m)
Viewing should not be done closer than the recommended distance.
- **Be careful of your surroundings when viewing 3D images. When you view 3D images, objects may appear closer or farther than they are. This may cause you to misjudge the distance and possibly result in injury if you accidentally hit the screen or surrounding objects.**
- **The 3D Glasses are not recommended for people aged less than 6.**
- **When children are viewing 3D images, be sure a parent or guardian is present. Monitor children viewing 3D images, and if they show signs of discomfort, immediately discontinue use of the 3D Glasses.**
- **People with a known history of photosensitivity and people with heart problems or poor health should not use the 3D Glasses. This can worsen existing health conditions.**
- **Do not use the 3D Glasses for other purposes (such as general eyeglasses, sunglasses, or protective goggles).**
- **Do not use the 3D function or 3D Glasses while walking or moving around. This may result in injuries due to running into objects, tripping, and/or falling.**
- **When using the 3D Glasses, take care not to accidentally strike the TV screen or other people. Viewing 3D images may cause you to misjudge the distance to the TV screen and accidentally strike the screen, resulting in possible injury.**
- **It is recommended that you do not view 3D images if you are sleep deprived or if you have been drinking alcohol.**

Display Methods for 3D and 2D Images

	Display method	Example display	Description
3D mode (using the 3D Glasses)	2D → 3D		• Converts normal 2D images into 3D images.
	Side by Side		• Creates 3D images from 3D images displayed side by side. The image is split into a left and right image, and then the images are stretched and displayed sequentially to create a 3D image.
	Top and Bottom		• Creates 3D images from 3D images displayed on the top and bottom. The image is split into a top and bottom image, and then the images are stretched and displayed sequentially to create a 3D image.
2D mode (without using the 3D Glasses)	Side by Side → 2D		• Creates 2D images from 3D images displayed side by side. Only the left image is stretched and displayed. The image does not appear in 3D.
	Top and Bottom → 2D		• Creates 2D images from 3D images displayed on the top and bottom. Only the top image is stretched and displayed. The image does not appear in 3D.

Viewing 3D Images

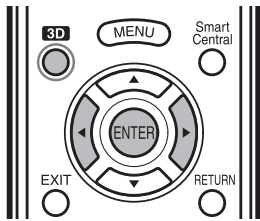

NOTE

- The TV screen may temporarily become black when the TV is trying to detect a 3D image signal and when switching from 3D to 2D mode.

Receiving a 3D Image Signal That Can Be Detected Automatically

The image signal may contain a 3D identification signal. You can enable the TV to automatically detect the 3D image type by selecting “System Options” > “3D Setup” > “3D Auto Change” on the TV. (See page 46.)

1 When “3D Auto Change” is set to “Mode 1” or “Mode 2”

- The 3D image type is detected automatically and the appropriate 3D image is displayed.

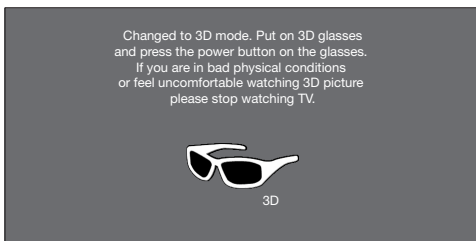

When “3D Auto Change” is set to “Off”

- The following message is displayed. Press **3D**.

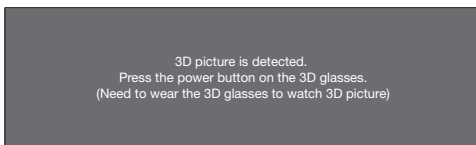

- Press **3D** to select the "Yes", and then press **ENTER**.



- Turn on the 3D Glasses and place them on your head.
- You can now view 3D images.

Switching from 3D to 2D Mode

- Press **3D** during the 3D mode. Select “Yes” and press **ENTER** to switch to 2D mode.



- Take off the 3D Glasses and turn off the power.

Ending 3D Image Viewing

- Take off the 3D Glasses and turn off the power.

NOTE

- If the input signal switches to 2D, 2D images are displayed automatically.
- 3D mode is canceled automatically when the setting is changed, input selection is changed, or the power is turned off.

Receiving a 3D Image Signal That Cannot Be Detected Automatically

- Press **3D**.

- A screen appears prompting you to select between 3D and 2D image viewing.



- Press **3D** or **2D** to select “3D” or “2D”, and then press **ENTER**.

- To view in 3D mode:** Select “3D”, and then go to step 3.
- To view in 2D mode:** Select “2D”, and then go to step 6.

- Press **3D** or **2D** to select the 3D signal type (“2D→3D”, “Side by Side” or “Top and Bottom”) and then press **ENTER**.

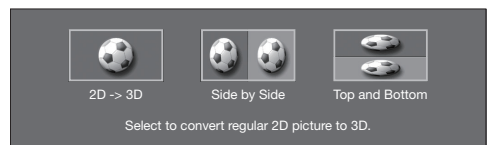

- If you select the same system as that of the input signal, 3D images are displayed.

- Turn on the 3D Glasses and place them on your head.
- You can now view 3D images.

Enjoying 3D Image Viewing

Switching from 3D to 2D Mode

- 6 Press ◀▶ to select the 2D signal type ("Side by Side" or "Top and Bottom") and then press **ENTER**.

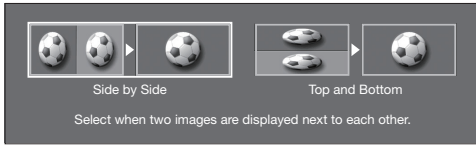

- If you select the same system as that of the input signal, 2D images are displayed.
- Take off the 3D Glasses and turn off the power.

Ending 3D Image Viewing

- 7 Take off the 3D Glasses and turn off the power.

Watching 2D Images in 3D

You can convert normal 2D images into 3D images.

- 1 Press **3D**.
- 2 Press ◀▶ to select "2D→3D convert", and then press **ENTER**.
- 3 Turn on the 3D Glasses and place them on your head.

NOTE

- The TV returns to 2D mode after 1 hour has passed.

Switching to the Previous Mode

You can switch back to the previous mode by pressing **3D**.

- 1 Press **3D**.
 - A confirmation screen is displayed.



- 2 Select "Yes" and then press **ENTER**.
 - The TV returns to the previous mode.

3D Menu

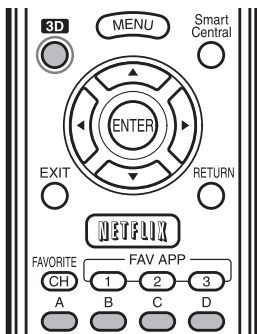

Pressing **3D** in 3D mode displays the 3D menu. Press the colored buttons to make the necessary settings.

- A:** 3D Brightness Boost
- B:** 3D Surround (See page 31.)
The surround mode changes each time you press **B**.
- C:** 2D→3D Convert Effect (See page 46.)
- D:** 3D Setup (See page 46.)

Configuring the TV Settings to Enhance 3D Image Viewing

Example

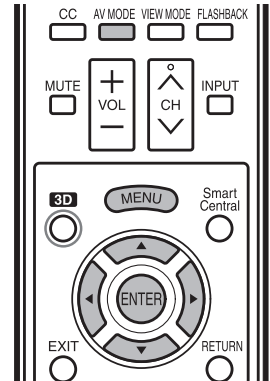
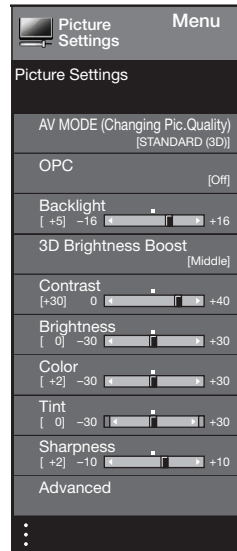

- 1 Press **MENU** to display the MENU screen, and then press ◀▶ to select "Picture Settings".
- 2 Press ▲/▼ to select a specific adjustment item, and then press **ENTER**.
- 3 Press ▲/▼ (or ◀▶) to select the desired item, and then press **ENTER**.
- 4 Press **MENU** to exit.

NOTE

- Which items can be selected/adjusted differs depending on whether the TV is in 2D mode or in 3D mode.

AV MODE

The audio and video settings can be changed to suit the program or input content being watched.

STANDARD(3D): For a highly defined image in a normal lighting.

MOVIE(3D): For a movie.

GAME(3D): Lowers image brightness for easier viewing.

NOTE

- You can select AV MODE by pressing **AV MODE** on the remote control unit.

3D Brightness Boost

You can adjust the backlight of the TV for 3D image viewing.

High/Middle/Low: Select a desired level of 3D Brightness Boost.

NOTE

- When "High" or "Low" is selected, "OPC", "Backlight" and "Range of OPC" are not available.

Enjoying 3D Image Viewing

3D Setup

You can make various settings to enhance 3D image viewing.

Example

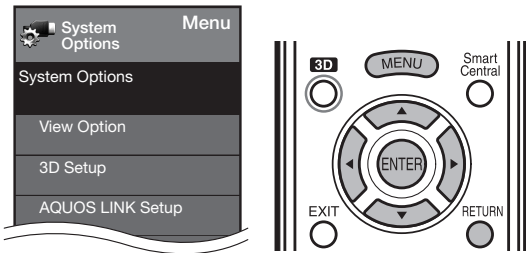

- 1 Press **MENU** to display the MENU screen, and then press **◀/▶** to select "System Options".
- 2 Press **▲/▼** to select "3D Setup", and then press **ENTER**.
- 3 Press **▲/▼** to select a specific item, and then press **ENTER**.
- 4 Press **▲/▼** (or **◀/▶**) to select the desired setting, and then press **ENTER**.
- 5 Press **MENU** to exit.

3D Auto Change

This setting can be used to switch to 3D mode automatically when a 3D identification signal is detected.

Set the desired mode according to the type of media you are viewing, such as video from a connected device or video from an internet application.

Mode 1: 3D mode is selected automatically when a 3D signal is detected while viewing video from a VOD service or HDMI-connected equipment.

Mode 2: 3D mode is selected automatically when, in addition to detecting a 3D signal while viewing video from a VOD service or HDMI-connected equipment, a video pattern with "Side by Side" or "Top and Bottom" format is also detected.

Off: Auto change is not performed.

NOTE

- This function does not work when the input source is Composite, Component, RGB or Analog/Digital tuner.

3D Depth Control

Select the method for adjusting the 3D depth.

Auto: Adjusts the depth automatically.

Manual: Manually adjusts the depth using the function "Depth Change".

NOTE

- This function is only available when the input signal is 3D.
- This function is not displayed depending on the type of 3D signal.

Depth Change

Adjusts the depth manually. "0" is the level where no adjustment is made.

NOTE

- This function is only available when "3D Depth Control" is "Manual".

2D→3D Convert Effect

You can adjust the 3D effect when converting images from 2D mode to 3D mode.

Select a desired level of convert effect from +1 to +16.

NOTE

- This function is only available when converting 2D images to 3D images.
- When you use this function, image conversion on the TV will result in some differences in the original images and how they appear.
- 2D images that have been converted to 3D images may be viewed only for personal use.

Viewing Time Info

This displays the elapsed time of 3D image viewing.

Yes: Displays the elapsed viewing time on the screen every hour.

No: Does not display the elapsed viewing time.

3D Test

This displays 3D images for testing the 3D operation. Clicking "Start" on the screen plays back 3D test images.

- If you press **RETURN** during playback, the previous screen will be displayed.

3D Glasses Control

To enable this function, set "TV Location" to "Store". Selecting "Yes" prevents the 3D Glasses from receiving 3D signals from other TVs.

Enjoying 3D Image Viewing

NOTE

- Appropriate 3D Glasses (sold separately) are required to view 3D images. Purchase 3D Glasses for use with Sharp brand 3D LCD TVs.

■ 3D Glasses lenses

- Do not apply pressure to the lenses of the 3D Glasses. Also, do not drop or bend the 3D Glasses.
- Do not scratch the surface of the lenses of the 3D Glasses with a pointed instrument or other object. Doing so may damage the 3D Glasses and reduce the quality of the 3D image.
- Use only the cloth provided with the optional 3D Glasses to clean the lenses.

■ 3D Glasses infrared receiver

- Do not allow the infrared receiver to become dirty, and do not attach stickers to or otherwise cover the infrared receiver. Doing so may prevent the receiver from operating normally.
- If the 3D Glasses are affected by other infrared data communication equipment, the 3D images may not be displayed correctly.

■ Caution during viewing

- Do not use devices that emit strong electromagnetic waves (such as cellular phones or wireless transceivers) near the 3D Glasses. Doing so may cause the 3D Glasses to malfunction.
- The 3D Glasses cannot operate fully at extreme high or low temperatures. Please use them within the specified usage temperature range.
- If the 3D Glasses are used in a room with fluorescent lighting (60 Hz), the light within the room may appear to flicker. In this case, either darken or turn off the fluorescent lights when using the 3D Glasses.
- Wear the 3D Glasses correctly. 3D images will not be correctly visible if the 3D Glasses are worn upside down or back-to-front.
- Other displays (such as computer screens, digital clocks, and calculators) may appear dark and difficult to view while wearing the 3D Glasses. Do not wear the 3D Glasses when watching anything other than 3D images.
- If you lie on your side while watching the TV with 3D Glasses, the picture may look dark or may not be visible.
- Be sure to stay within the viewing angle and optimum TV viewing distance when watching 3D images. Otherwise, you may not be able to enjoy the full 3D effect.
- The 3D Glasses may not work properly if there is any other 3D product or electronic devices turned on near the glasses or TV. If this occurs, turn off the other 3D product or electronic devices or keep the devices as far away as possible from the 3D Glasses.
- Stop using the 3D Glasses in any of the following situations:
 - When images consistently appear doubled while you are wearing the 3D Glasses
 - When you have difficulty perceiving the 3D effect
- If the 3D Glasses are faulty or damaged, stop using them immediately. Continued use of the 3D Glasses may cause eye fatigue, headaches and illness.
- If you have any abnormal skin reaction, stop using the 3D Glasses. In very rare instances, such reactions may be due to an allergic reaction to the coating or materials used.
- If your nose or temples become red or you experience any pain or itchiness, stop using the 3D Glasses. Pressure caused by long periods of use may lead to such reactions and may result in skin irritation.

■ Usage range of the 3D Glasses

- The 3D Glasses can be used by receiving an infrared signal sent from the TV.
Operating range:
From directly in front of the 3D infrared emitter on the TV: approx. 17 ft (5 m)
(within approx. 30° horizontally and 20° vertically)
 - The 3D infrared emitter lights in 3D mode.
- For further details, refer to the operation manual of your 3D Glasses.

Enjoying Photo/Music/Video Playback

You can connect the TV to a USB memory device, USB hard drive or home network (DLNA) server to enjoy viewing pictures, listening to music, and watching videos.

NOTE

- Depending on the USB memory device/USB hard drive/home network (DLNA) server, the TV may not be able to recognize the recorded data.
- It may take time to read the recorded data if the USB memory device/USB hard drive/home network (DLNA) server contains many files or folders.
- Use only alphanumeric characters for naming files.
- File names over 80 characters (may vary depending on character set) may not be displayed.

Connecting a USB Memory Device/USB Hard Drive

Insert the USB memory device with recorded photos, music or videos into the USB 1 or USB 2 terminal on the TV.

- If USB memory devices are inserted into both terminals, the USB 1 terminal has priority.

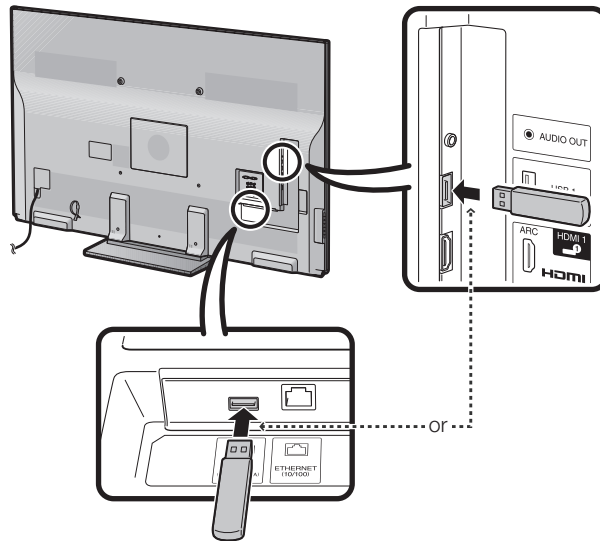

- When connecting a USB hard drive, be sure to use a hard drive with an AC adapter.
- Do not remove a USB memory device or memory card from the TV while transferring files, using the slide show function, or switching screens, or before you exit "USB" from the INPUT list.
- Do not insert and remove a USB memory device/USB hard drive to and from the TV repeatedly.
- When using a card reader, be sure to insert Memory first before using the card reader.
- USB input cannot be selected when displaying the browser. Close the browser first.

CAUTION

- **Do not use a USB extension cable when connecting a USB memory device to the USB terminal on the TV.**
- **Using a USB extension cable with the USB memory device may prevent the TV from performing correctly.**

Connecting a Home Network (DLNA) Server

Connect the TV to the home network (DLNA) server using an ETHERNET cable.

- You can also connect a Home Network (DLNA) server by using a wireless LAN.

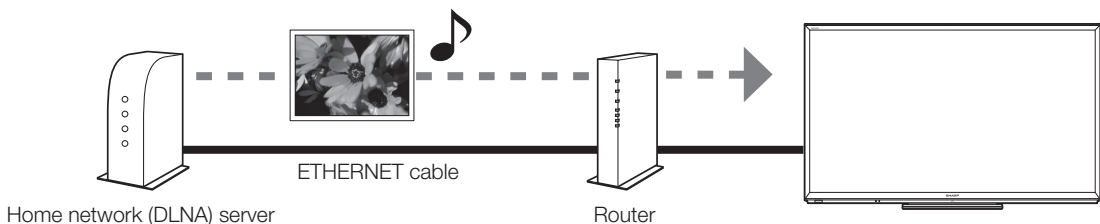

NOTE

- Do not disconnect a home network (DLNA) server from the TV while transferring files, when a screen is switching to another or before you exit "Home Network (DLNA)" from the INPUT list.
- Do not connect and disconnect a home network (DLNA) server from the TV repeatedly.

Enjoying Photo/Music/Video Playback

Selecting the Folders to Play Back

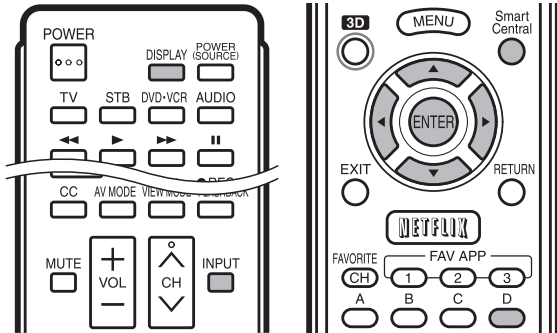

- To play back data on a USB memory device, insert the USB memory device on the TV. USB mode is selected automatically. (Go to step 2)
- Use the following procedure to switch back to USB mode after switching from USB mode to another mode.

- Select "USB" or "Home Network (DLNA)" from INPUT list screen.
- Press **D**.
- Press **▲/▼** (or **◀/▶**) to select the drive/server where you want to find your files, and then press **ENTER**.
 - For USB mode, select the drive.
 - When in DLNA mode, select the server.
- Press **◀/▶** to select "Photo", "Music" or "Video", and then press **ENTER**.

Example

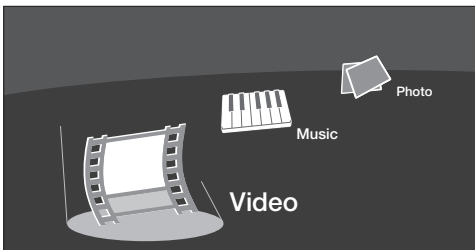

- Press **◀/▶** to select the desired folder, and then press **ENTER**.

NOTE

- The Media screen can be displayed even by using the application window. To display the application window, press **SmartCentral**. (See page 24.)
- You cannot switch the input mode if a USB memory device is not connected.
- You do not need to select the drive/server in step 2 when there is only one drive in the connected USB memory device or there is only one home network (DLNA) server connected to the TV.
- 16 is the maximum number of USB drives and 10 is the maximum number of home network (DLNA) servers that can be displayed.
- If the TV is turned off and then on again, the number assigned to the USB drive may change.
- "VIEW MODE" is fixed during the Photo or Music mode. During "Video mode", you can select "Auto" or "Original".
- The key guide display disappears automatically after a particular time has elapsed. To display the key guide display again, press **DISPLAY**.

USB Device Compatibility

USB device	USB Memory, USB card reader (Mass Storage class), USB hard drive
File system	FAT/FAT32/NTFS (USB hard drive only)
Photo file format	JPEG (.jpg) (DCF2.0 compliant) Multi-Picture Format (.mpo) (CIPA DC-007 Compliant) MP Type : Multi view individually image (stereoscopic view)
Music file format	MP3 (.mp3) Bitrate: 32k, 40k, 48k, 56k, 64k, 80k, 96k, 112k, 128k, 160k, 192k, 224k, 256k, 320kbps Sampling frequency: 32k, 44.1k, 48kHz

Video file format

File extension	Container	Video	Audio
.avi	AVI	DivX 3.11/4.x/5.1/6.0 XviD H.264 MPEG4 Motion Jpeg	MP3 Dolby Digital LPCM ADPCM
.mkv	MKV	DivX 3.11/4.x/5.1/6.0 XviD H.264 MPEG4	MP3 Dolby Digital LPCM ADPCM
.asf .wmv	ASF	DivX 3.11/4.x/5.1/6.0 XviD MPEG4 VC-1 Windows Media Video v9	MP3 Dolby Digital LPCM WMA
.mp4 .mov .3gp	MP4 (SMP4)	H.264 MPEG4 Motion Jpeg	MP3 AAC
.vro .mpg .mpeg	PS	MPEG2 MPEG1	Dolby Digital MPEG LPCM

NOTE

- Progressive format jpeg files are not supported.
- USB 1.1 devices may not be played properly.
- Operation using USB hubs is not guaranteed.
- Some video file formats may not be played depending on the file.
- Some images may not be displayed in the appropriate aspect ratio depending on the file format.

Home Network (DLNA) Server Compatibility

Photo file format	JPEG
Music file format	LPCM, MP3
Video file format	MPEG2-PS, MPEG2-TS, WMV, ASF, MP4, MOV, AVI

NOTE

- Progressive format jpeg files are not supported.
- Some video file formats may not be played depending on the file or the server.
- WMV, ASF, MP4, MOV and AVI are non-DLNA contents.

Playing Back Files on a USB Memory Device/Home Network (DLNA) Server

Photo Mode

Viewing Thumbnails

Example

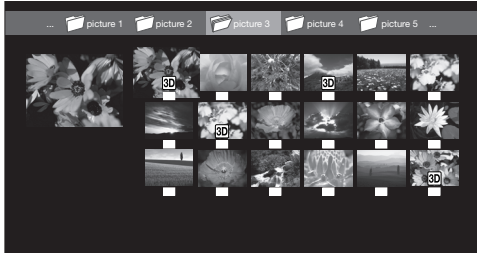

This screen image is for the USB mode. It may be slightly different in the Home network (DLNA) mode.

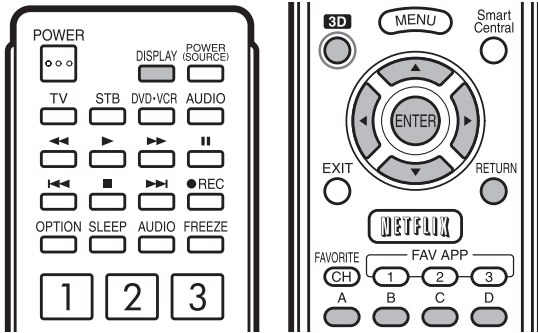

Buttons for thumbnail operations

Buttons	Description
▲/▼/◀/▶	Select a desired item.
ENTER	When selecting a folder icon: Enter this directory. When selecting a photo thumbnail: Enlarge the photo.
RETURN	Return to the previous process.
A (red)	USB mode: Select the images to be displayed. Press this button to add or remove a checkmark. Home Network (DLNA) mode: Display the Media screen.
B (green)	Display the music list screen. You can select the background music to be played for the slide show.
C (blue)*	Start the slide show.
D (yellow)	Display the USB MENU/Home Network (DLNA) Menu screen.

* This function is available only for the USB mode.

NOTE

- When there are invalid photo files, the **X** mark will be displayed for the file. (USB mode only.)
- The icon **3D** appears on the thumbnails of 3D images. If you do not switch to 3D mode for the 3D images, they will be displayed in 2D. (USB mode only.)
- You can see the file name, shooting date, file size and pixel size of the selected photo in the lower-left corner of the screen (shooting date is only available in the EXIF file format).

Viewing Individual Photos

The photo selected on the thumbnail selection screen is displayed.

Buttons for individual display operation

Buttons	Description
◀/▶	Go to the previous/next photo in the same directory.
RETURN	Return to the thumbnail selection screen.
3D	Switches between 2D and 3D modes.
A (red)	Rotate the photo by 90 degrees to the left.
B (green)	Rotate the photo by 90 degrees to the right.

NOTE

- Rotating photos only applies to the temporarily selected item and this setting is not saved.
- In 3D mode, you cannot rotate the photos.
- The key guide display disappears automatically after a particular time has elapsed. To display the key guide display again, press **DISPLAY**.

Slide Show

The photos displayed on the thumbnail selection screen are displayed as a slide show.

Buttons for slide show operation

Buttons	Description
RETURN	Return to the thumbnail selection screen.
3D	Switches between 2D and 3D modes.
D (yellow)	Display the USB MENU/Home Network (DLNA) Menu screen.

NOTE

- The selected BGM is played repeatedly.
- The slide show continues until you press **RETURN**.
- For setting the slide show speed, select "Select Slide Show Interval" on the USB MENU/Home Network (DLNA) Menu screen.
- The key guide display disappears automatically after a particular time has elapsed. To display the key guide display again, press **DISPLAY**.

Enjoying Photo/Music/Video Playback

USB Menu

On the menu to be displayed in USB mode, use ▲/▼ to select an item and make settings to your preferences.

Example

USB MENU	
3D Display	[On]
Select Slide Show Interval	[10sec]
Select Slide Show BGM	
Set All Slide Show Image	
Reset All Slide Show Image	
Remove USB Device	

3D Display

You can view photos in 3D.

On: Displays the photos in 3D.

Off: Normal viewing mode.

NOTE

- You can select "3D display" from "USB MENU" only when the thumbnails screen for the photo mode in USB mode is displayed on the screen.
- Depending on the file, the photos may not be displayed in 3D.

Select Slide Show Interval

Specify the length of time before the next image appears.

Press ▲/▼ to select the desired length of the time, and then press **ENTER**.

5sec/10sec/30sec/60sec

NOTE

- For DLNA mode, follow the same procedure.
- Depending on the photo files, the length of the slide show interval may differ from the selected interval time.

Select Slide Show BGM

The music list screen appears when you select "Select Slide Show BGM".

You can select the music to be played in the background while the slide show is being displayed.

- Select the music you want to play from the music list.
 - For operations on the music list screen, see "Music Mode".
- Press **RETURN** to display the thumbnail selection screen, and then press **C** to start the slide show and the background music.

NOTE

- All of the music files are selected by default.

Set/Reset All Slide Show Image

Selecting "Set All Slide Show Image" or "Reset All Slide Show Image" will display the thumbnail selection screen. On the screen, set or reset the images to be displayed in the slide show.

Set All Slide Show Image: Checkmarks are added to all the images.

Reset All Slide Show Image: Remove all the checkmarks from all the images.

Remove USB Device

To remove the USB device properly, use ◀/▶ to select "Yes" and then press **ENTER**.

Music Mode

Example

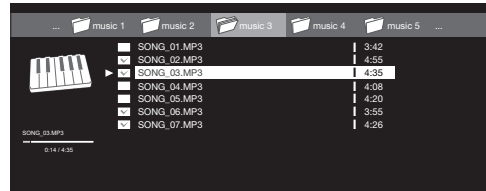

This screen image is for the USB mode. It may be slightly different in the Home network (DLNA) mode.

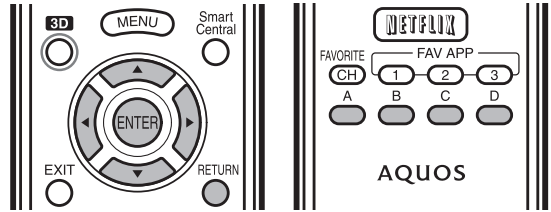

Buttons for music mode

Buttons	Description
▲/▼/◀/▶	Select a desired item.
ENTER	When selecting a folder icon: Enter this directory. When selecting a music file: Play music.
RETURN	Return to the previous process.
A (red)	USB mode: Select the music to be played back. Press this button to add or remove a checkmark. ----- Home Network (DLNA) mode: Display the Media screen.
B (green)	Stop music.
C (blue)	Play/Pause music.
D (yellow)*	Display the USB MENU screen.

* This function is available only for the USB mode.

NOTE

- When there are invalid music files, the **X** mark will be displayed for the file. (USB mode only.)
- The displayed play time may differ slightly from the actual play time depending on the files.

Enjoying Photo/Music/Video Playback

USB Menu

On the menu to be displayed in USB mode, use ▲/▼ to select an item and make settings to your preferences.

Example



* See page 51 for details on the Remove USB Device function.

■ Set/Reset All Auto Play

Selecting "Set All Auto Play" or "Reset All Auto Play" will display the music list screen. On the screen, set or reset the music to be played back in the slide show.

Set All Auto Play: Checkmarks are added to all the music files.

Reset All Auto Play: Remove all the checkmarks from all the music files.

Video Mode

Example



This screen image is for the USB mode. It may be slightly different in the Home network (DLNA) mode.

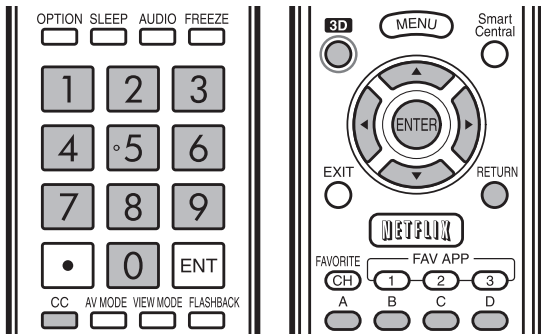

Buttons for file selecting operations

Buttons	Description
▲/▼/◀/▶	Select a desired item.
ENTER	When selecting a folder icon: Enter this directory. When selecting a music file: Play the video.
RETURN	Return to the previous process.
A (red)	USB mode: Select/deselect items (checkmarks are added to the selected items). ----- Home Network (DLNA) mode: Display the Media screen.
D (yellow)*	Display the USB MENU screen.

* This function is available only for the USB mode.

Buttons for playing mode

Buttons	Description
▲	Go to the beginning of a file by pressing ▲ once and the previous file by pressing ▲ twice.
▼	Go to the next file.
▶	USB mode: The fast forward speed changes every time you press ▶. After playing to the end, the TV goes to the next file and starts to play. ----- Home Network (DLNA) mode: Jump forward in a video. *2
◀	USB mode: The reverse speed changes every time you press ◀. After going back to the beginning, the TV starts to play the same file. ----- Home Network (DLNA) mode: Jump back in a video. *2
ENTER	USB mode: Pause the video. ----- Home Network (DLNA) mode: Play/Pause the video. *2
RETURN	Go back to the file selection screen.
3D	Switches between 2D and 3D modes.
A (red)*1	Jump to the scene where playback was last stopped.
B (green)	Stop a video.
C (blue)	Display the USB/home network (DLNA) operation panel.
D (yellow)*1	Display the USB MENU screen.
0-9*1	Jump to a point in the video during playback of a file without chapters. You can jump to a later point by pressing a higher number.*3

*1 These functions are available only for the USB mode.

*2 Jump forward/back and play/pause may not be available depending on the files.

*3 During playback of a file without chapters, playback points are set automatically. Playback points are set at intervals of a one-tenth of playback time.

Example for a file with a playback time of 100 minutes:
Pressing **1** jumps 10 minutes forward, and pressing **2** jumps 20 minutes forward. Pressing **0** returns to the start of the file being played back.

Enjoying Photo/Music/Video Playback

■ Using the operation panel

You can use the operation panel for video playback operations.

You can call up this operation panel by pressing **MENU** after you press ▲/▼ to select "USB Operation Panel"/"Home Network (DLNA) Operation Panel" from "System Options" > "View Option".

Example



Buttons for using the USB operation panel

◀◀	Hold down to go in reverse.
▶	Starts playback.
▶▶	Hold down to fast forward.
◀◀	Video without chapters: Press one time to return to the previous playback point.* Press two times to return to the previous file. Video with chapters: Press one time to return to the previous chapter. Press two times to return to the previous file.
	Sets pauses and still pictures.
▶▶	Video without chapters: Press one time to advance to the next playback point.* Press two times to display the next file. Video with chapters: Press one time to advance to the next chapter. Press two times to display the next file.
Audio	Change the audio when multiple audio is available for the video you are watching.
■	Playback stops.
CC	Change the Closed Caption display.
Title	Displays the title (edition).
Resume jump	Jump to the scene where playback was last stopped.

* During playback of a file without chapters, playback points are set automatically. Playback points are set at intervals of a one-tenth of playback time.

Example for a file with a playback time of 100 minutes: Playback points are set every 10 minutes. Pressing ▶▶ one time after viewing the file for 15 minutes jumps to the 20-minute playback point.

NOTE

- Reverse/fast forward continues from one file to another during continuous playback.
- Use "CC" on the operation panel to change the Closed Caption display. You can also switch the Closed Caption display by using "System Options" > "View Option" > "Change CC" or by pressing **CC** on the remote control unit.
- Use "Audio" on the operation panel to change the audio. You can also switch the audio by using "System Options" > "View Option" > "Change Audio".

Buttons for using the Home Network (DLNA) operation panel

▶	Starts playback.
◀◀	Go to the beginning of a file by pressing once or to the previous file by pressing twice.
	Sets pauses and still pictures.
▶▶	Go to the next file.
■	Playback stops.
↶	Jump back in a video.
↷	Jump forward in a video.

USB Menu

On the menu to be displayed in USB mode, use ▲/▼ to select an item and make settings to your preferences.

Menu for file selecting operations

Example



* See page 51 for details on the Remove USB Device function.

■ Set/Reset All Auto Play

Selecting "Set All Auto Play" or "Reset All Auto Play" will display the video list screen. On the screen, set or reset the video to be played back in the slide show.

Set All Auto Play: Checkmarks are added to all the video files.

Reset All Auto Play: Remove all the checkmarks from all the video files.

Menu for playing mode

Example

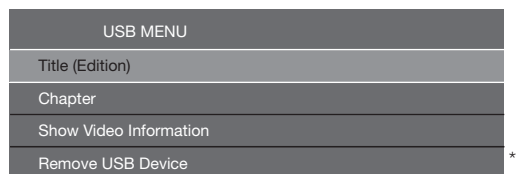

* See page 51 for details on the Remove USB Device function.

■ Title (Edition)/Chapter

Selecting "Title (Edition)" or "Chapter" will display a list of titles/chapters contained in the video file. Select the title or chapter you want to play back.

- The selected title or chapter is played back.
- "0-9" is displayed for files without chapters. Playback jumps to the playback point of the selected number.

NOTE

- If there is Edition information, this screen is displayed when the title is selected.
- If there is no title or edition, you cannot select "Title (Edition)".
- "Chapter" cannot be selected when there is no chapter.

■ Show Video Information

The information of the current file is displayed.

Example

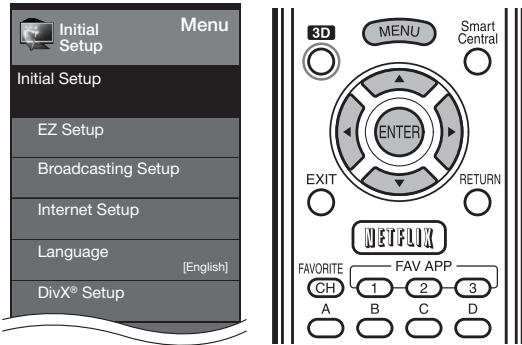

DivX® Setup

This is the function to confirm your registration code. You need to register the code at <http://www.divx.com>.

- 1 Press **MENU** to display the menu screen.
- 2 Press **◀/▶** to select "Initial Setup", and then press **ENTER**.
- 3 Press **▲/▼** to select "DivX® Setup", and then press **ENTER**.

■ DivX® VOD registration

You can find your registration code on this menu. You need to register the TV at <http://www.divx.com> before playing the DivX content.

■ DivX® VOD deregistration

You can find your deregistration code on this menu. You need to deregister the TV at <http://www.divx.com> to release the registration.

NOTE

- This function is available only for the USB mode.
- This function may not work while an Internet application is being used.

Playing Back Files from a Portable Device or PC

With the remote playback function, you can use your portable device to play back pictures, video, and music on the home network server.

- This TV is a DLNA certified Digital Media Renderer. (DMR)
- To use the remote playback function, your portable device must be a DLNA Certified Digital Media Controller.
- A wireless access point is required to use a portable device.

Set Up Home Network

Make the settings for remote playback.

- 1 Press **◀/▶** to select "Initial Setup", and then press **ENTER**.
- 2 Press **▲/▼** to select "Internet Setup", and then press **ENTER**.
- 3 Press **▲/▼** to select "Set Up Home Network", and then press **ENTER**.
- 4 Press **▲/▼** to select the specific adjustment item, and then press **ENTER** to set each item.

■ Remote Control Play Settings

This setting allows the TV to perform remote playback.

Permitted: Allows remote playback.

Not allowed: Does not allow remote playback.

■ Timeout Setup

This sets the time until the TV returns automatically to TV mode after remote playback ends.

10 sec./60 sec.: When the set time has elapsed after remote playback ends, the TV returns automatically to TV mode.

No: Select this to manually switch the TV after remote playback ends.

NOTE

- This function may not work while an Internet application is being used.
- For information on the compatible formats, see "Home Network (DLNA) Server Compatibility" on page 49.

Other Viewing Options

Presetting Remote Control Function

You can operate the connected AV products (AV receiver, cable box, SAT tuner, DTV, VCR, BD, DVD, LD) using the presetting manufacturer function of your remote control unit.

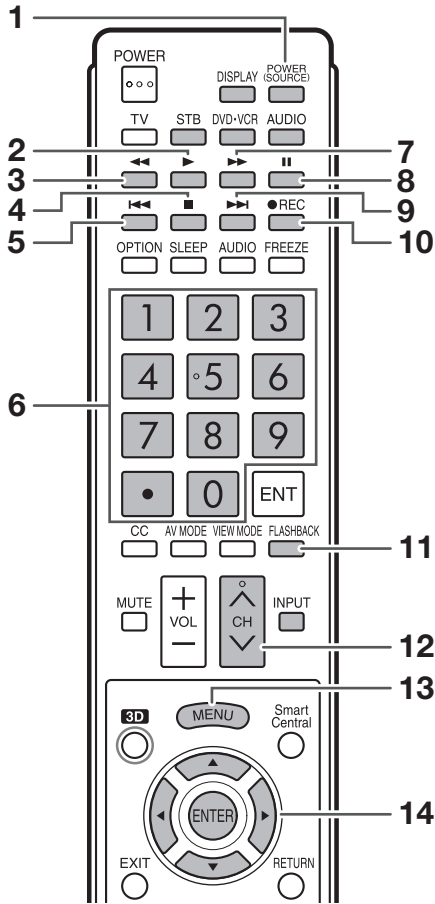

Presetting manufacturer codes

- 1 Press an appropriate button (**STB**, **DVD•VCR** or **AUDIO**) to operate the connected equipment.
- 2 Press an appropriate button (**STB**, **DVD•VCR** or **AUDIO**) and **DISPLAY** at the same time to enter the code registration mode.
- 3 Press **0-9** to enter the manufacturer code. (See page 56.)
 - Preset mode is finished once the LED no longer lights up.
- 4 After registering the code, the LED will stop blinking then turn off after one second. (If you perform an incorrect operation, the LED will blink quickly then turn off.)

Operating the Connected Equipment

To operate the connected equipment, press **STB**, **DVD•VCR** or **AUDIO** to select your device. (STB (cable/satellite set-top box), BD, DVD, VCR or AUDIO.) The remote control unit button will function as follows.

- When you operate VCR, DVD or BD, press **INPUT** to select the terminal connected to your device.
- CABLE and SAT cannot be selected at the same time.

1 POWER (SOURCE)

- Turns the connected equipment power on and off.

2 ▶

- Starts playback. (VCR, BD, DVD)

3 ◀◀

- Rewinds the tape and allows picture search. (VCR)
- Hold down to go in reverse. (BD, DVD)

4 ■

- Stops the tape transport. (VCR)
- Playback stops when pressed. With some Blu-ray disc/DVD players, pressing the button twice may open the disc tray. (BD, DVD)

5 ◀◀◀

- Pressing quickly once takes you to the start of the chapter currently playing. Each time you press it, you move back to the start of the previous chapter. (BD, DVD)

6 0-9, • (DOT) (STB)

- Press a button (or buttons) that corresponds to the channel that you wish to watch.

7 ▶▶

- Rapidly advances the tape and allows picture search. (VCR)
- Hold down to fast forward. (BD, DVD)

8 ||

- Sets pauses and still pictures. (VCR, BD, DVD)

9 ▶▶▶

- Pressing quickly once takes you to the start of the next chapter. Each time you press it, you move ahead to the start of the next chapter. (BD, DVD)

10 ●REC

- Starts recording. (VCR)

11 FLASHBACK

- Press to switch between the current channel and the channel you were watching immediately before. Some manufacturers do not preset FLASHBACK. (STB)

12 CH ^/v

- Press **CH^** or **CHv** to tune in to a higher or lower channel. (STB)
- Press to select the channel of the TV tuner on the VCR. (VCR)

13 MENU

- When this button is pressed, the BD/DVD menu will display. (BD, DVD)

14 ▲/▼/◀/▶, ENTER

- **▲/▼/◀/▶**: Press the button to select items on the STB GUIDE screen or STB MENU screen. (STB)
Press the button to select items on the BD/DVD menu screen. (BD, DVD)
- **ENTER**: Press to activate the selected function. (STB, BD, DVD)

Other Viewing Options

Manufacturer codes

VCR BRAND	REMOTE CONTROL CODE NUMBER
AUDIO DYNAMICS	09
BROCKSONIC	13
CANON	04
CRAIG	12
CURTIS MATHIS	04
DBX	09
EMERSON	10, 13, 14
GE	04
INSTANT REOLYA	04
JC PENNEY	04
JVC	09, 16, 17, 22
KENWOOD	09
MAGNAVOX	04, 05, 06
MAGNIN	12
MEMOREX	04
MONTGOMERY WARD	02
NEC	09
PANASONIC	04, 18, 19, 20, 21
PENTAX	05
PHILCO	04, 05
PHILIPS	04, 05, 06
QUASAR	04
REALISTIC	01, 02
SAMSUNG	11, 12
SHARP	01, 02, 03
SONY	07, 08, 15
SYLVANIA	04, 05, 06
TATUNG	09
TEAC	09
TMK	10
YAMAHA	09

STB BRAND	REMOTE CONTROL CODE NUMBER
ANVISION	04, 05
CABLE STAR	04, 05
DISH NETWORK	39, 40
DIRECTV	41
EAGLE	05
G.INSTRUMENT	02, 03, 10, 11, 17, 20
GERROLD	17
JERROLD	02, 03, 10, 11, 12, 20, 25-34
MAGNAVOX	04, 05, 08, 12, 15, 16, 18, 19, 22, 23
MOTOROLA	38
OKA SIGMA	07
PANASONIC	14, 21
PHILIPS	04, 05, 08, 13, 15, 16, 18, 19, 22, 23
PIONEER	07
RANDTEK	04, 05
RCA	14, 36*, 37*
S.ATLANTA	01, 09, 24
VIEWSTAR	04, 05, 08, 13, 15, 16, 18, 19, 22, 23
ZENITH	06, 35

NOTE

- Numbers marked with * are SAT codes, all others are STB codes.

BD/DVD/LD BRAND	REMOTE CONTROL CODE NUMBER
DENON	24
JVC	31
KENWOOD	36
MAGNAVOX	26
MARANTZ	26
mitsubishi	28
PANASONIC	24, 37
PHILIPS	26, 38
PIONEER	30, 33, 35
PROSCAN	25
RCA	25, 39
SAMSUNG	29, 34
SHARP	23, 32, 41, 42
SONY	27, 40
TOSHIBA	26
YAMAHA	24
ZENITH	26

AUDIO BRAND	REMOTE CONTROL CODE NUMBER
SHARP	01
SHARP (SOUND BAR)	02

- Depending on the brand, the codes of some BD players may not be supported.

Using AQUOS LINK

Controlling HDMI Equipment Using AQUOS LINK

What's AQUOS LINK?

- Using the HDMI CEC (Consumer Electronics Control) protocol, with AQUOS LINK you can interactively operate compatible system equipment (Blu-ray disc equipment, AV amplifier, DVD).
- By connecting AQUOS LINK-compatible devices with HDMI-certified cables to the TV, you can control a recorder or AV amplifier using the remote control of the TV.
- AQUOS LINK allows you to operate the HDMI-connected equipment with one remote control.

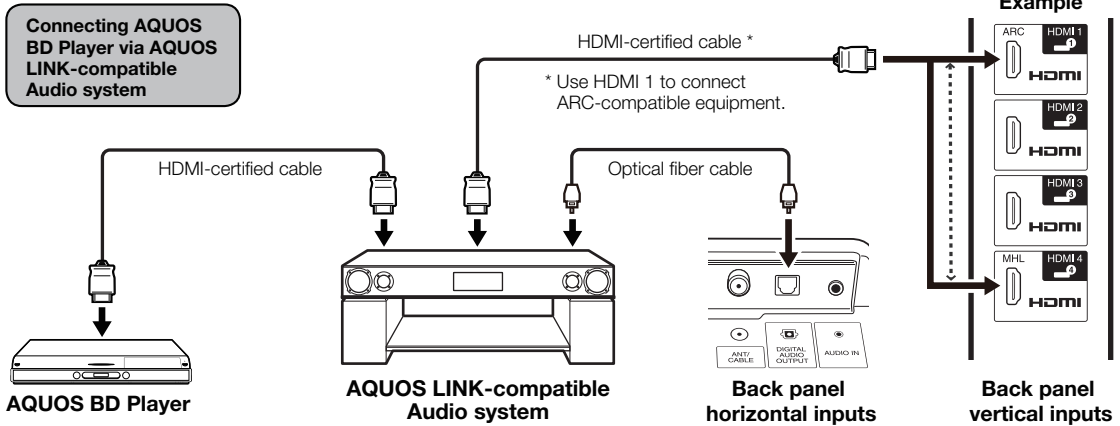

NOTE

- For connecting the TV to AQUOS LINK-compatible equipment, use commercially available cables.
- Point the remote control toward the TV, not to connected HDMI equipment.
- Video noise may occur depending on the type of HDMI cable used. Make sure to use an HDMI-certified cable.
- Up to 3 pieces of HDMI recording equipment and one AV amplifier can be connected using this system.
- These operations affect the HDMI equipment selected as the current input source. If the equipment does not operate, turn on the equipment and select the appropriate input source using **INPUT**.
- The AQUOS LINK feature may not operate properly when an HDMI splitter or AV selector unit is used. These devices may cause interruptions to the image and/or sound.

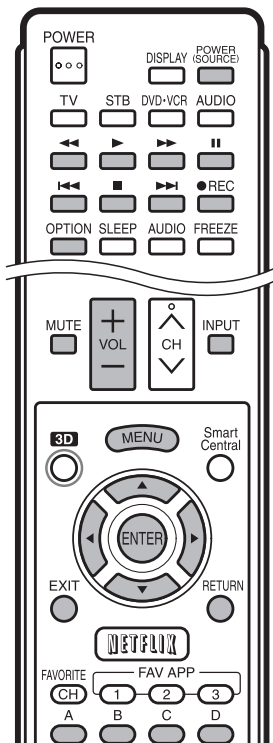

Connected AQUOS LINK-compatible devices can be operated without changing the settings of the remote control unit.

OPTION button will function only when AQUOS LINK is used.

■ One Touch Play

While the TV is in standby mode, it automatically turns on and plays back the image from the HDMI source.

■ One Touch Recording

Press **REC** while you are viewing a broadcast received with the AQUOS LINK-compatible recorder. The AQUOS LINK automatically recognizes the connected HDMI device and starts recording.

■ Single remote control

The AQUOS LINK automatically recognizes the connected HDMI device and you can control the TV and the devices as if using a universal remote control.

■ Control the AQUOS LINK-compatible audio system

Set the volume of AQUOS LINK-compatible audio system.

NOTE

- The above description is an example of the AQUOS LINK function.
- The steps in "AQUOS LINK Setup" on page 58 need to be completed beforehand.
- Refer to this operation manual and the operation manual of the AQUOS LINK device to be used with this TV.

AQUOS LINK Setup

Example

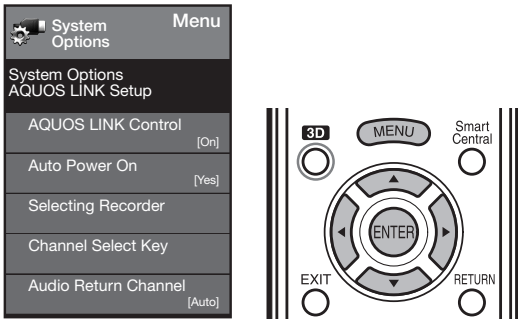

- 1 Press **MENU** to display the MENU screen, and then press ◀▶ to select "System Options".
- 2 Press ▲/▼ to select "AQUOS LINK Setup", and then press **ENTER**.
- 3 Press ▲/▼ to select a specific item, and then press **ENTER**.
- 4 Press ▲/▼ (or ◀▶) to select the desired setting, and then press **ENTER**.
- 5 Press **MENU** to exit.

AQUOS LINK Control

Select AQUOS LINK Control to disable AQUOS LINK function even when an AQUOS LINK-compatible HDMI device is connected to the TV. This function prevents the device from starting to operate unexpectedly.

- On:** You can operate AQUOS LINK-compatible equipment.
- Off:** AQUOS LINK function does not work.

Auto Power On

If this is activated, the One Touch Play function is enabled.

- Yes:** While the TV is in standby mode, it automatically turns on and plays back the image from the HDMI source.
- No:** This function does not work.

Selecting Recorder

When multiple AQUOS LINK-compatible devices are connected, this function allows you to set the recorder for recording when you press ●REC on the TV's remote control unit.

Press ▲/▼ to select the recorder for recording.

Channel Select Key

This function can be set for each input terminal.

- On:** The remote control unit of the TV can be used to select the channel, display program information, and perform other operations of the connected AQUOS LINK-compatible equipment.
- Off:** This function does not work.

Audio Return Channel

This function allows you to listen to the TV audio via audio equipment without using an optical fiber cable, which conventionally is required.

Requirements for using an ARC-compatible AV amplifier:

- ARC-compatible AV amplifier connected to the ARC-compatible HDMI terminal (HDMI 1). (Refer to the operation manual of the ARC-compatible equipment for details.)
- Use of an ARC-compatible cable.
 - Auto:** You can listen to the TV audio with ARC-compatible audio equipment.
 - Off:** This function does not work.

NOTE

- If the TV audio cannot be output from the AV amplifier even after making the necessary settings, connect the TV to the AV amplifier with an optical fiber cable and select "Off".

One Touch Playback

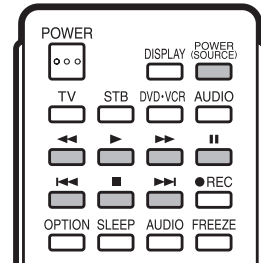

AQUOS LINK allows you to operate the HDMI-connected equipment with one remote control.

Press ▶ to start playing back a title.

- The last played program is played back. You can use the following buttons during broadcast viewing.

Buttons	Description
POWER (SOURCE)	Turns the power of the HDMI connected devices on and off.
◀◀	Hold down to go in reverse.
▶	Starts playback.
▶▶	Hold down to fast forward.
■	Playback stops.
	Sets pauses and still pictures.
◀◀◀	Pressing quickly once takes you to the start of the chapter currently playing. Each time you press it, you move back to the start of the previous chapter.
▶▶▶	Pressing quickly once takes you to the start of the next chapter. Each time you press it, you move ahead to the start of the next chapter.

NOTE

- The buttons ◀◀◀/▶▶▶ do not function with the following Blu-ray disc players currently available.
 - BD-HP20U, BD-HP50U

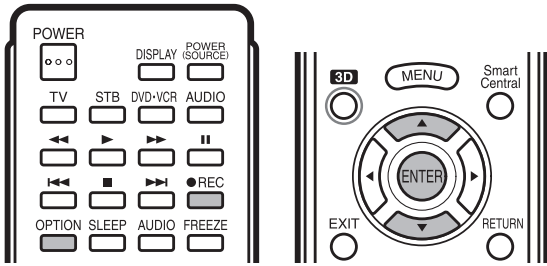

One Touch Recording

This function allows easy one-touch recording of the program being viewed on the TV to AQUOS LINK-compatible equipment with a recording function by simply pressing **REC** on the remote control.

Prepare the connected AQUOS LINK-compatible recorder for recording. Check the following items.

- Make sure that the antenna cable is connected.
- Check that there is sufficient available space on the recording media (HDD, DVD, etc.).
- On the TV, use "AQUOS LINK Setup" and "Selecting Recorder" to select the equipment for recording.
- By default, the recorder connected to HDMI 1 is selected for recording.

1 Press **REC to start recording.**

- When you are viewing a broadcast received with the AQUOS LINK-compatible recorder selected in "Selecting Recorder", recording to the AQUOS recorder of the broadcast being viewed starts.
- When you are viewing a broadcast received with equipment other than the AQUOS LINK-compatible recorder selected in "Selecting Recorder" or other external input equipment, pressing **REC** on the remote control does not start recording.

2 Use the Link Operation Menu to stop recording.

- ① Press **OPTION** to display the Link Operation Menu screen.
- ② Press **▲/▼** to select "Stop Recording", and then press **ENTER**.

Start/Stop Recording

You can also use the Link Operation Menu for recording on the connected AQUOS LINK-compatible equipment.

1 Press **OPTION to display the Link Operation Menu screen.**

2 Select "Start Recording", and then press **ENTER to start recording.**

- You can also start recording by pressing **REC** on the remote control unit.

3 Select "Stop Recording", and then press **ENTER to stop recording.**

Link Operation Menu

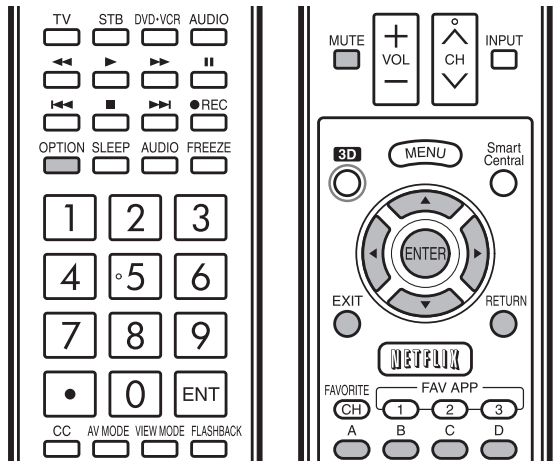
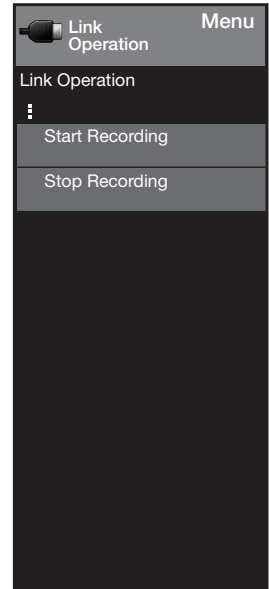
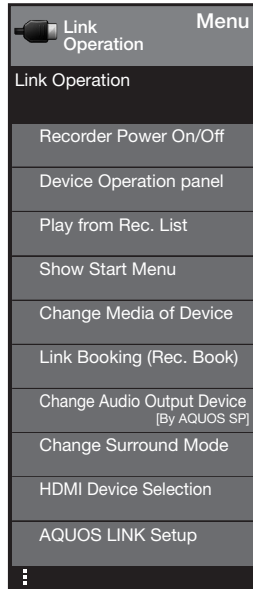

The Link Operation Menu allows you to make adjustments during operation of AQUOS LINK-compatible equipment.

1 Press **OPTION to display the Link Operation Menu.**

2 Press **▲/▼ to select the desired item, and then press **ENTER**.**

- Specific operations differ depending on the item you select. Following are the basic operations for each item.

Using AQUOS LINK

Recorder Power On/Off

You can manually turn on/off the power of the connected AQUOS LINK-compatible equipment. Each time you press **ENTER**, the connected equipment switches on or off.

Device Operation Panel

You can use the device operation panel to control playback operations.

Press **▲/▼/◀/▶** to select the desired operation.

NOTE

- This function works only when AQUOS LINK-compatible equipment with the Device Operation Panel function is connected.

Play from Rec. List

This function allows you to display the title list for the connected equipment and to play back the title you want to enjoy.

Before using this function.

Power on the AQUOS LINK-compatible equipment, and select the appropriate external input.

Select the title with **▲/▼/◀/▶**, and then press **▶** to start playback.

NOTE

- This function works only when AQUOS LINK-compatible equipment is connected.

Show Start Menu

You can call up a setup menu from the connected AQUOS LINK-compatible equipment.

NOTE

- Depending on the status of the equipment (recording or in standby mode, etc), the setup menu will not be displayed.
- The setup menu will not be displayed with the player BD-HP20U currently available.

Change Media of Device

You can switch the media (HDD or DVD) for playback or recording on the AQUOS LINK-compatible recorder.

- The Media type toggles each time you press **ENTER** in "Change Media of Device".

Link Booking (Rec. Book)

You can call up the AQUOS LINK-compatible recorder's EPG and preset timer recordings using the TV's remote control.

Select the program on the recorder's EPG.

- You can use **▲/▼/◀/▶**, **ENTER**, **RETURN**, **EXIT** and the colored buttons.

NOTE

- This function works only when an AQUOS LINK-compatible recorder is connected.
- Refer to the operation manual of the recorder for details.

Change Audio Output Device

You can select to listen to the TV sound only from the AQUOS LINK-compatible audio system.

By AQUOS audio SP: The sound from the TV speaker is muted and only the sound from the AQUOS LINK-compatible audio system is audible.

- You can use **VOL+/-** and **MUTE**.

By AQUOS SP: The sound is output from the TV speaker.

Change Surround Mode

You can manually change the AQUOS AUDIO speaker system's sound mode.

The sound mode changes each time you press **ENTER**.

- Refer to the operation manual of the AQUOS LINK-compatible audio system for details.

HDMI Device Selection

If multiple HDMI devices are connected in a daisy chain, you can specify which device to control here. Press **▲/▼** to select the desired device from a list of connected HDMI devices, and then press **ENTER**.

AQUOS Link Setup

You can also display the AQUOS LINK Setup screen from the Link Operation Menu.

Using a Smartphone with the TV

This function enables you to connect the TV to a smartphone that supports Mobile High-Definition Link (MHL) using an MHL-compatible cable.

To connect the TV to your MHL-compatible smartphone, be sure to use an MHL-compatible cable (commercially available).

- You can view pictures and video on a large screen.
- You can play back music files.

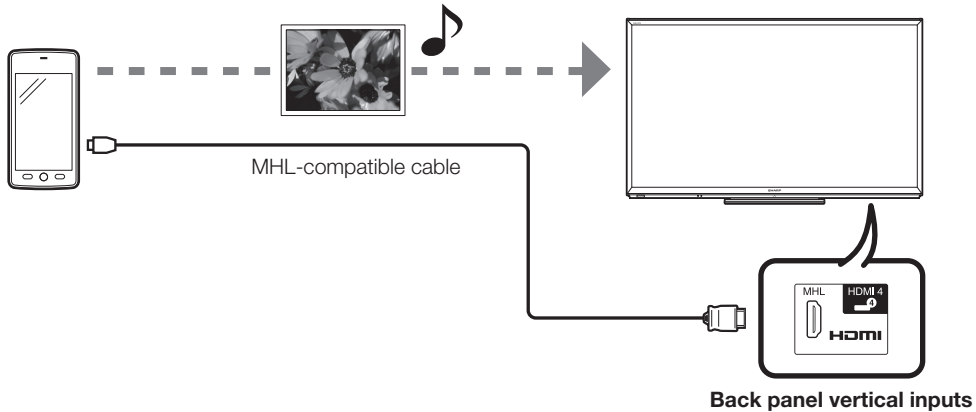

NOTE

- An MHL-compatible portable device is required to use this function. Connect the device to the HDMI 4 terminal.

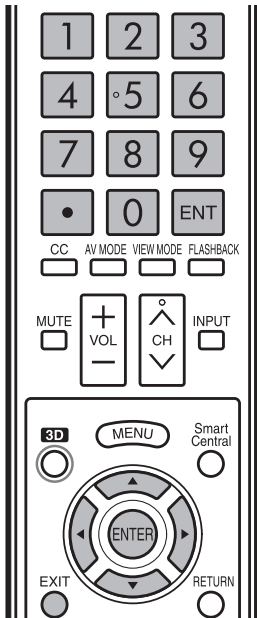

■ Auto Power On

When an MHL-compatible device is connected to the TV, the TV turns on automatically.

- This function operates when "AQUOS LINK Control" is set to "On". (See page 58.)

■ Auto Input Selection

When an MHL-compatible device is connected while the TV is on, the input mode is selected automatically.

- This function operates when "AQUOS LINK Control" is set to "On". (See page 58.)

■ Operation Using the Remote Control

The remote control of the TV can be used to operate a portable device.

- ▲/▼/◀/▶, **ENTER**, **EXIT**, **0-9**, • (DOT), **ENT**, etc.
- The operations vary depending on the connected equipment and content being viewed.

Using a PC

Displaying a PC Image on the Screen

VIEW MODE

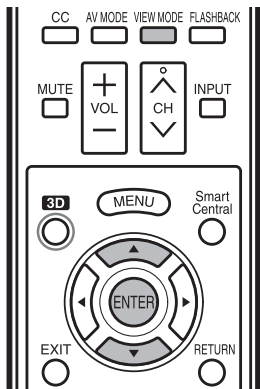

You can select the screen size.

1 Press VIEW MODE.

- The View Mode menu displays.
- The menu lists the View Mode options selectable for the type of video signal currently being received.

2 Press VIEW MODE or ▲/▼ while the View Mode menu is displayed to select a desired item on the menu.

- You can sequentially select a View Mode that has its own aspect ratio.

NOTE

- Connect the PC before making adjustments. (See page 18.)
- Selectable screen size may vary with input signal type.
- You can have the same settings by choosing "View Mode" on the menu items. (See page 33.)
- You may not be able to change the View Mode while in 3D mode.

Example: Screen size images

<p>Input signal</p> <p>4:3</p>	<p>Normal</p> <p>Keeps the original aspect ratio in a full screen display.</p>	<p>Zoom</p> <p>For viewing widescreen programs. The top and bottom of the image is cropped.</p>	<p>Stretch</p> <p>An image fully fills the screen.</p>	<p>Dot by Dot</p> <p>Detects the resolution of the signal and displays an image with the same number of pixels on the screen.</p>
<p>Input signal</p> <p>16:9</p>	<p>Stretch</p> <p>An image fully fills the screen.</p>	<p>Dot by Dot</p> <p>Detects the resolution of the signal and displays an image with the same number of pixels on the screen.</p>		

Using a PC

Example

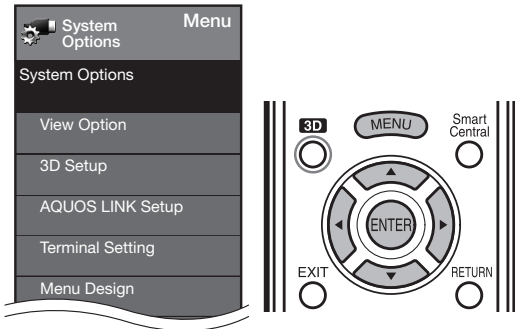

- 1 Press **MENU** to display the MENU screen, and then press **◀▶** to select "System Options".
- 2 Press **▲▼** to select "Terminal Setting", and then press **ENTER**.
- 3 Press **▲▼** to select "PC input" or "Audio Select", and then press **ENTER**.
- 4 Press **▲▼** to select a specific adjustment item, and then press **ENTER** to set each item.
- 5 Press **▲▼** (or **◀▶**) to select or adjust the desired setting, and then press **ENTER**.

Adjusting the PC Image

Auto Sync. (for Analog PC Input Mode Only)

For automatically adjusting the PC image.

Yes: Auto Sync. starts and "Now adjusting the image." displays.

No: This function does not work.

NOTE

- When "Auto Sync." is successful, "Completed" displays. If not, "Auto Sync." failed.
- "Auto Sync." may fail even if "Completed" displays.
- "Auto Sync." may fail if the computer image has low resolution, has unclear (black) edges, or is moved while executing "Auto Sync.".
- Be sure to connect the PC to the TV and switch it on before starting "Auto Sync.".

Fine Sync.

Ordinarily you can easily adjust the picture as necessary to change image position using "Auto Sync.". In some cases, however, manual adjustment is needed to optimize the image.

H-Pos.: Centers the image by moving it to the left or right.

V-Pos.: Centers the image by moving it up or down.

Clock: Adjust when the image flickers with vertical stripes.

Phase: Adjust when characters have low contrast or when the image flickers.

NOTE

- For resetting all "Fine Sync." adjustment items to the factory preset values, press **▲▼** to select "Reset", and then press **ENTER**.
- It is not necessary to adjust the "Clock" or "Phase" when a digital signal is being input, so it cannot be selected.
- The default cursor position may not be in the center, because the screen position variable ranges may be asymmetrical.
- The screen position variable ranges depend on the View Mode or the signal type. The ranges can be seen on the position-setting screen.

Setting Audio Input

Audio Select

This function sets the terminal to output the computer audio.

The adjustment items vary depending on the input source. Select the input source corresponding to the terminal connected to the PC and then adjust the desired item.

■ PC IN

Video: Select this when the TV and PC are connected using an analog RGB cable and the audio is not input.

Video+Audio: Select this when the TV and PC are connected using an analog RGB cable and the audio is input via a Ø 3.5 mm stereo minijack.

■ HDMI 2

HDMI(Digital): Select this when the TV and PC are connected using an HDMI-certified cable and audio is input via the same cable.

HDMI+Analog: Select this when the TV and PC are connected using a DVI-HDMI conversion cable and the audio is input via a Ø 3.5 mm stereo minijack.

NOTE

- When "Audio Select" is set to "HDMI(Digital)", sound will not be produced if you use only an HDMI-certified cable to connect HDMI-compatible equipment. To produce sound, you should make an analog audio connection.
- If you want to connect HDMI-compatible equipment using only an HDMI-certified cable, set "Audio Select" to "HDMI(Digital)".

PC Compatibility Chart

It is necessary to set the PC correctly to display XGA and WXGA signal.

Resolution		Horizontal Frequency	Vertical Frequency	VESA Standard
VGA	720 x 400	31.5 kHz	70 Hz	—
	640 x 480	31.5 kHz	60 Hz	○
37.9 kHz		72 Hz	○	
37.5 kHz		75 Hz	○	
SVGA	800 x 600	35.1 kHz	56 Hz	○
		37.9 kHz	60 Hz	○
		48.1 kHz	72 Hz	○
		46.9 kHz	75 Hz	○
XGA	1024 x 768	48.4 kHz	60 Hz	○
		56.5 kHz	70 Hz	○
		60.0 kHz	75 Hz	○
WXGA	1360 x 768	47.7 kHz	60 Hz	○
SXGA	1280 x 1024	64.0 kHz	60 Hz	○
SXGA+	1400 x 1050	65.3 kHz	60 Hz	○
UXGA	1600 x 1200	75.0 kHz	60 Hz	○
1080p	1920 x 1080	67.5 kHz	60 Hz	—

VGA and XGA are registered trademarks of International Business Machines Corp.

Control of the TV

- The TV can be controlled from a PC, control panels and other devices using the RS-232C or IP.
- Use a cross-type RS-232C cable, ETHERNET cable (commercially available) or wireless LAN for the connections.

NOTE

- This operation system should be used by a person who is accustomed to using computers.

AQUOS Remote Control

Example

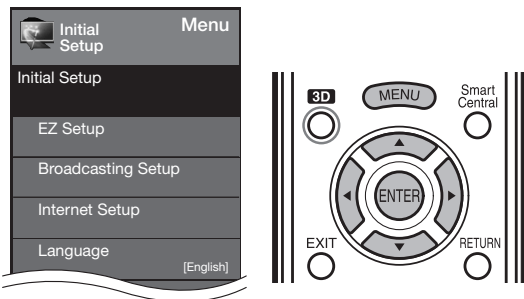

- 1 Press **MENU** to display the MENU screen, and then press **◀▶** to select "Initial Setup".
- 2 Press **▲▼** to select "Internet Setup", and then press **ENTER**.
- 3 Press **▲▼** to select "AQUOS Remote Control", and then press **ENTER**.

■ AQUOS Remote Control

Set this when operating the TV from equipment connected by LAN or wireless LAN.

- When "AQUOS Remote Control" is selected, "Change" will be highlighted. Press **ENTER**.
Enable: Allows operation from the connected equipment.
Disable: This function does not work.

■ Select Device Names

Set the name of the TV displayed on the portable device.

- Use the software keyboard to set the name. See page 69 for details on the software keyboard.

■ Detailed Settings

Make the detailed settings (Login ID, password, etc.). Follow the on-screen instructions to configure the settings.

Communication Conditions for IP

Connect to the TV with the following settings made for IP on the PC.

IP protocol:	TCP/IP
Host IP address:	Set the IP address on the TV menu
Service:	None (Do not select Telnet or SSH)
TCP port#:	Set a port number on the TV menu (Control port)

When you set your ID and password on the TV menu, you need to enter them as soon as you connect to the TV.

NOTE

- When you use this function, make settings for "AQUOS Remote Control".
- The connection will be cut off when there has been no communication for 3 minutes.

Communication Conditions for RS-232C

Set the RS-232C communication settings on the PC to match the TV's communication conditions. The TV's communication settings are as follows:

Baud rate:	9,600 bps
Data length:	8 bits
Parity bit:	None
Stop bit:	1 bit
Flow control:	None

■ Communication procedure

Send the control commands from the PC via the RS-232C or IP.

The TV operates according to the received command and sends a response message to the PC.

Do not send multiple commands at the same time. Wait until the PC receives the OK response before sending the next command.

■ Command format

Eight ASCII codes + CR

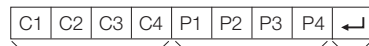

Command 4-digits: Command. The text of four characters.
 Parameter 4-digits: Parameter 0-9, x, blank, ?

■ Parameter

Input the parameter values, aligning left, and fill with blank(s) for the remainder. (Be sure that 4 values are input for the parameter.)

When the input parameter is not within an adjustable range, "ERR" returns. (Refer to "Response code format".) Any numerical value can replace the "x" on the table.

0				When "?" is input for some commands, the present setting value responds.	?			
0	0	0	9		?	?	?	?
-	3	0						

■ Response code format

Normal response

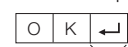

Return code (0DH)

Problem response (communication error or incorrect command)



Return code (0DH)

Using a PC

■ Command table

- Commands not indicated here are not guaranteed to operate.

CONTROL ITEM		COMMAND	PARAMETER	CONTROL CONTENTS		
POWER ON COMMAND SETTING		R S P W	0	Off	The Power On command rejected.	
			1	On [RS-232C]	The Power On command accepted.	
			2	On [IP]	The Power On command accepted. When the power is in standby mode, commands also go to waiting status and so power consumption is just about the same as usual. With the commands in waiting status, the Center Icon Illumination on the front of the TV lights up.	
POWER SETTING	P O W R	0	Power Off	It shifts to standby.		
			1	Power On	Power On	
INPUT SELECTION	TOGGLE	I T G D	x	(Toggle)	It input-switches by the toggle. (It is the same as an input change key)	
	TV	I T V D	0		It input-switches to TV. (A channel remains as it is. (Last memory))	
1-8		I A V D	*			
AV MODE SELECTION		A V M D	*			
				0: HDMI 1, 2: HDMI 2, 3: HDMI 3, 4: HDMI 4, 5: COMPONENT, 6: VIDEO 1, 7: VIDEO 2, 8: PC		
				0: (Toggle), 1: STANDARD, 2: MOVIE, 3: GAME, 4: USER, 5: DYNAMIC (Fixed), 6: DYNAMIC, 7: PC, 8: x.v.Color, 14: STANDARD (3D), 15: MOVIE (3D), 16: GAME (3D), 100: AUTO	Although it can choose now, it is toggle operation in inside.	
VOLUME		V O L M	*		Volume (0-60)	
POSITION	H-POSITION	H P O S	*			
	V-POSITION	V P O S	*			
	CLOCK	C L C K	*		Only PC mode. (0-180)	
	PHASE	P H S E	*		Only PC mode. (0-40)	
VIEW MODE		W I D E	*			
				0: (Toggle) [AV], 1: Side Bar [AV], 2: S.Stretch [AV] 3: Zoom [AV], 4: Stretch [AV], 5: Normal [PC] 6: Zoom [PC], 7: Stretch [PC], 8: Dot by Dot [PC] [AV], 9: Full Screen [AV] 10: Auto [USB-Video, DLNA-Video or Internet applications], 11: Original [USB-Video, DLNA-Video or Internet applications]	0: Although it can choose now, it is toggle operation in inside. 1: Only available when 4:3 signal is being input. 5, 6: Only available when 4:3 signal is being input. 8: [PC] Available except when UXGA is being input. [AV] Only available when 1080i/p is being input. 9: Only available when 720p is being input. 10, 11: Available when USB-Video, DLNA-Video or Internet application is used.	
MUTE		M U T E	*		0: (Toggle), 1: On, 2: Off	
SURROUND		A C S U	*		0: (Toggle), 1: Normal, 2: Off, 4: 3D Hall, 5: 3D Movie, 6: 3D Standard, 7: 3D Stadium	
AUDIO SELECTION		A C H A	x		(Toggle)	
SLEEP TIMER		O F T M	*		0: Off, 1: OFF TIMER - 30 MIN., 2: OFF TIMER - 60 MIN., 3: OFF TIMER - 90 MIN., 4: OFF TIMER - 120 MIN.	
CHANNEL	DIRECT CHANNEL (ANALOG)	D C C H	*		The channel number of TV (1-135)	
					An input change is included if it is not TV display. In Air, 2-69ch is effective. In Cable, 1-135ch is effective.	
	DIRECT CHANNEL (DIGITAL)	D A 2 P	*		(0100-9999)	DIGITAL Air (Two-Part numbers, 2-digit plus 2-digit)
		D C 2 U	*		(1-999)	DIGITAL Cable (Two-Part numbers, 3-digit plus 3-digit) Front half of DIGITAL CABLE CHANNEL NO. (Designate major channel)
		D C 2 L	*		(0-999)	DIGITAL Cable (Two-Part numbers, 3-digit plus 3-digit) Rear half of DIGITAL CABLE CHANNEL NO. (Designate minor channel)
		D C 1 0	*		(0-9999)	DIGITAL Cable (One-Part numbers, 5-digit, less than 10,000)
		D C 1 1	*		(0-6383)	DIGITAL Cable (One-Part numbers, 5-digit, more than 10,000)
	CH UP	C H U P	x		The channel number of TV +1	If it is not TV display, it will input-switch to TV. (same function as CH \wedge)
CH DOWN	C H D W	x		The channel number of TV -1	If it is not TV display, it will input-switch to TV. (same function as CH \vee)	
CC		C L C P	x		(Toggle)	
DEVICE NAME		T V I N M	1		The device name set in "IP Control Setup" is displayed.	
MODEL NAME		M I N R D	1		The model name of the TV	
SOFTWARE VERSION		S W V N	1		The current version of the TV software is displayed.	
IP PROTOCOL VERSION		I P P V	1		The currently supported version of IP protocol is displayed.	
3D		T D C H	*		0: 3D Off 1: 2D-3D 2: SBS 3: TAB 4: 3D-2D (SBS) 5: 3D-2D (TAB) 6: 3D auto 7: 2D auto	
REMOTE CONTROL BUTTONS		R C K Y	*		0-9: 0-9, 10: ENT, 11: POWER, 13: DISPLAY, 14: POWER (SOURCE) 15: \blacktriangleleft , 16: \blacktriangleright , 17: \blacktriangleright , 18: \blacksquare , 19: \blacktriangleleft , 20: \blacksquare , 21: \blacktriangleright , 22: \bullet REC, 23: OPTION, 24: SLEEP, 27: CC, 28: AV MODE, 29: VIEW MODE, 30: FLASHBACK, 31: MUTE, 32: VOL -, 33: VOL +, 34: CH \wedge , 35: CH \vee , 36: INPUT, 38: MENU, 39: SmartCentral, 40: ENTER, 41: \blacktriangle , 42: \blacktriangledown , 43: \blacktriangleleft , 44: \blacktriangleright , 45: RETURN, 46: EXIT, 47: FAVORITE CH, 48: 3D Surround, 49: AUDIO, 50: A (red), 51: B (green), 52: C (blue), 53: D (yellow), 54: FREEZE, 55: FAV APP 1, 56: FAV APP 2, 57: FAV APP 3, 58: 3D, 59: NETFLIX	

NOTE

- If an underbar ($_$) appears in the parameter column, enter a space.
- If an asterisk (*) appears, enter a value in the range indicated in brackets under CONTROL CONTENTS.
- Any numerical value can replace the "x" on the table.

Using the Internet

By connecting your TV to a broadband system, you can access the Internet from the TV.

- Use "AQUOS ADVANTAGE LIVE" to obtain the latest software and receive online user support. (See page 68.)
- You can enjoy a variety of streaming content and Internet applications. (See page 72.)

NOTE

- You may not be able to view 3D images when accessing the Internet.

Connecting to the Internet

- To connect your TV to the Internet, you must have a broadband Internet connection.
- If you do not have a broadband Internet connection, consult the store where you purchased your TV or ask your Internet service provider or telephone company.
- When an Internet connection is made, an Ethernet and wireless connection cannot be used at the same time. Use only one of the connection types. (See page 67.)

■ Using an ETHERNET cable

Use an ETHERNET cable (commercially available) to connect the ETHERNET terminal on the TV to your broadband router (commercially available).

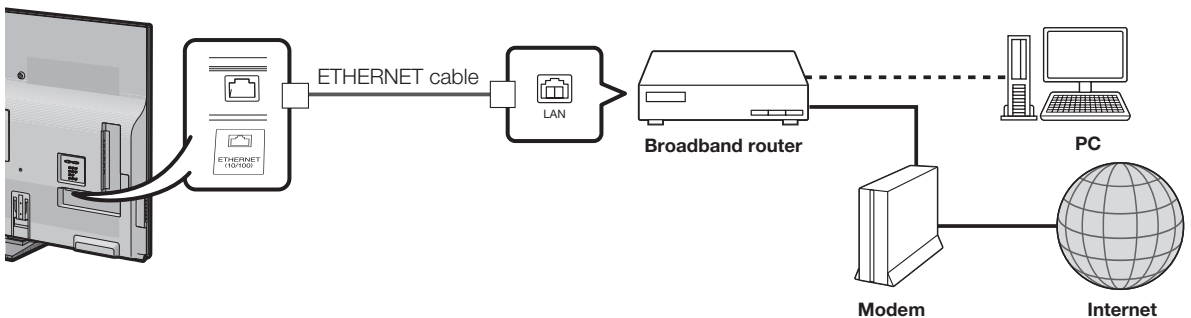

■ Using the wireless LAN

This TV is equipped with a wireless LAN function.

For a wireless LAN connection, you must use "Wireless Setup" to connect the access point and TV. (See page 67.)

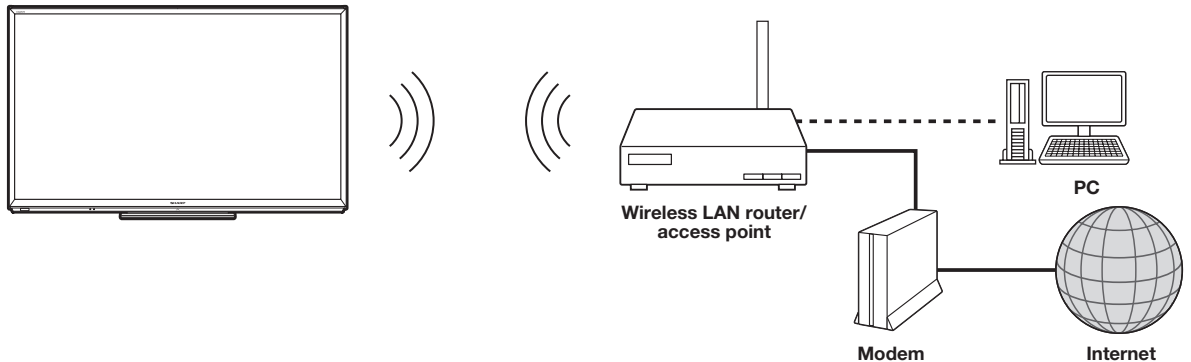

NOTE

- This TV has a built-in wireless LAN function. Using a separate wireless USB LAN adapter may result in radio communications that do not comply with regulations on radio communications. Therefore, do not use a separate wireless LAN adapter.
- A wireless LAN connection and performance cannot be guaranteed for all residential environments. In the following cases, the wireless LAN signal may be poor or drop, or the connection speed may become slower.
 - When used in buildings made with concrete, reinforced steel, or metal
 - When placed near objects that obstruct the signal
 - When used with other wireless devices that emit the same frequency
 - When used in the vicinity of microwave ovens and other devices that emit a magnetic field, electrostatic charge, or electromagnetic interference
- When there is significant interference in the 2.4-GHz frequency (such as from other wireless LAN devices, Bluetooth® devices, 2.4-GHz cordless telephones, and microwave ovens), it is recommended that you use a wireless LAN router/access point that supports IEEE802.11a/n (5 GHz) and set the access point to transmit at 5 GHz. For setup details, see the operation manual of your access point.

Internet Setup

Example

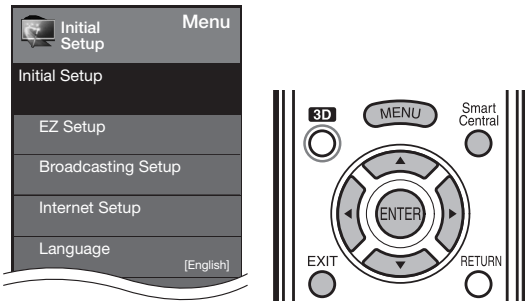

Connection Type

- 1 Press **MENU** to display the MENU screen, and then press **◀/▶** to select "Initial Setup".
- 2 Press **▲/▼** to select "Internet Setup", and then press **ENTER**.
- 3 Press **▲/▼** to select "Network Setup", and then press **ENTER**.
- 4 Press **▲/▼** to select "Manual Setup", and then press **ENTER**.
- 5 Press **◀/▶** to select "Yes", and then press **ENTER**.
- 6 Press **▲/▼** to select "Connection Type", and then press **ENTER**.
- 7 Press **◀/▶** to select "Wired" or "Wireless", and then press **ENTER**.
 - If you select "Wired", the signal is detected and setup is performed automatically. Use "IP Setup" to check and change the settings as necessary. (See page 68.)
 - If you select "Wireless", use "Wireless Setup" to configure the access point settings.

Wireless Setup

- If your access point supports Wi-Fi Protected Setup (WPS), it is recommended that you use this function for the wireless connection. You can press the WPS button on the access point to configure the settings automatically.
- The name of the WPS button function may differ depending on the access point. See the operation manual of the access point for details.
- 1 Confirm the current settings in "Connection Type".
 - If "Wired" is selected, press **◀/▶** to select "Wireless".
 - 2 Press **▲/▼** to select "Wireless Setup", and then press **ENTER**.
 - Confirm the settings. If each setting item is correct, press **MENU** to exit.
 - If you are configuring the wireless setup for the first time or changing the settings, go to step 3.
 - 3 Press **◀/▶** to select "Change", and then press **ENTER**.
 - 4 Press **▲/▼** to select "WPS", and then press **ENTER**.
 - To select and register an access point manually, select "Search" or "Manual Setup" and make the necessary settings.

- 5 Press **▲/▼** to select "Push button", and then press **ENTER**.
 - To configure the setting via PC, select "PIN code". Follow the on-screen instructions and the operation manual of the access point to configure the settings.
- 6 Select "Next" to complete the settings.
 - The connection process starts and the WPS button on the access point can be pressed.
- 7 Press the WPS button on the access point.
 - Pressing the WPS button displays a confirmation screen. Please wait until a connection is established.
- 8 When a connection is established, the connection details are displayed. Press **ENTER**.

NOTE

- Operations cannot be guaranteed when used with access points that do not have Wi-Fi® certification.
- A wireless LAN router/access point is required to connect the TV to the Internet using a wireless LAN. See the operation manual of your access point for setup.
- If your access point is set to a stealth mode (that prevents detection by other devices), you may not be able to establish a connection. In this case, disable the stealth mode on the access point.
- A stable connection speed is required to play back streaming content. Use an Ethernet connection if the wireless LAN speed is unstable.
- Before transferring to a third party or disposal, be sure to initialize the wireless LAN settings.
- Please follow the legislation in your country when using the wireless LAN outdoors.

Interactive Service

If you do not want other people to connect to the Internet in your absence, you can make settings to keep the TV away from the Internet.

- 1 Press **MENU** to display the MENU screen, and then press **◀/▶** to select "Initial Setup".
- 2 Press **▲/▼** to select "Internet Setup", and then press **ENTER**.
- 3 Press **▲/▼** to select "Interactive Service", and then press **ENTER**.
 - Input the 4-digit secret number by using **0-9**.
- 4 Press **◀/▶** to select "No", and then press **ENTER**.
 - If you want to allow Internet connection, select "Yes", and then press **ENTER**.
- 5 Press **MENU** to exit.

Using the Internet

Checking Your Internet Connection

- 1 Press **SmartCentral** to display the application window.
- 2 Press **◀/▶** to select "AQUOS ADVANTAGE LIVE", and then press **ENTER**.
 - If "❌" or "📶" is displayed after you connect to the Internet, check your TV's network settings and connection.
 - When the AQUOS ADVANTAGE LIVE screen appears, now you are connected to the Internet.
 - You can also display the AQUOS ADVANTAGE LIVE screen by pressing **FAV APP** on the remote control unit. See page 72 for details.

NOTE

- If you have failed to connect to the Internet in the above operation, then an error message will appear. In this case, press **EXIT** to exit from the connected TV feature to make changes to the network settings.
- If you still cannot connect to the Internet, please consult your Internet service provider or telephone company.
- When an application is used, you cannot make settings for "Internet Setup".

If you need to make the settings of "Internet Setup", press **EXIT** to exit from the connected TV feature.

■ If you cannot connect to the Internet

Perform the procedures below to check your TV's network settings.

IP Setup

- 1 Press **EXIT** to exit from the connected TV feature.
- 2 Press **MENU** to display the MENU screen, and then press **◀/▶** to select "Initial Setup".
- 3 Press **▲/▼** to select "Internet Setup", and then press **ENTER**.
- 4 Press **▲/▼** to select "Network Setup", and then press **ENTER**.
- 5 Press **▲/▼** to select "Manual Setup", and then press **ENTER**.
- 6 Press **◀/▶** to select "Yes", and then press **ENTER**.
- 7 Press **▲/▼** to select "IP Setup", and then press **ENTER**.
 - Check that numbers are displayed for each setting.
 - If there are any settings without numbers, specify the numbers by following the on-screen instructions.
 - For information on how to enter text, see page 69.

Example

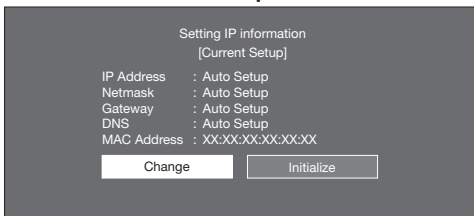

- 8 Press **MENU** to exit.

AQUOS Advantage Live

This function can be used to display up-to-date information and allow you to receive support service over the network.

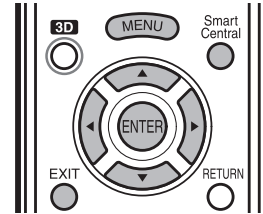

- 1 Press **SmartCentral** to display the application window.
- 2 Press **◀/▶** to select "AQUOS ADVANTAGE LIVE", and then press **ENTER**.
 - You can also display the AQUOS ADVANTAGE LIVE screen by pressing **FAV APP** on the remote control unit. See page 72 for details.
 - When you are not connected to the Internet, a network function explanation screen is displayed. The services displayed vary depending on circumstances.
- 3 Press **▲/▼/◀/▶** to select the desired service.
- 4 Press **EXIT** to exit from the connected TV feature.

NOTE

- The display may change as a result of a software update.

Using the Internet

Entering Text (Software Keyboard)

When you are editing an input screen or specifying the Ethernet settings used for accessing the Internet, enter text from the software keyboard.

NOTE

- You can enter up to 128 characters for text.
- Some special characters or diacritics may not be available depending on where you enter the text.

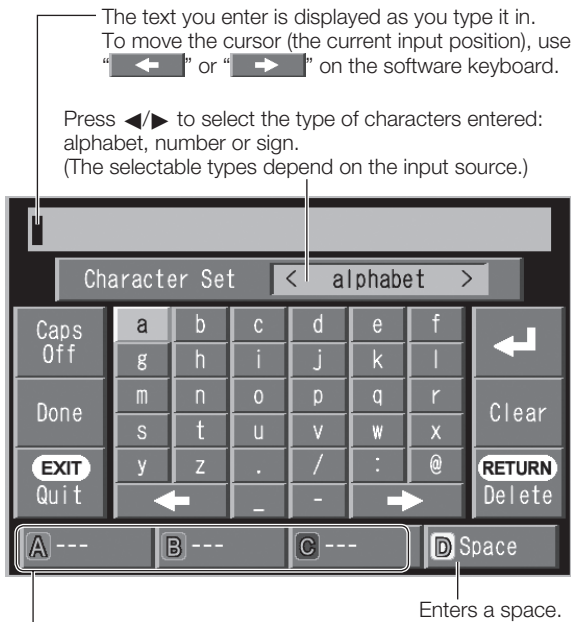

While you are entering text, likely input conversion candidates are displayed based on what you typed in.

- You can also enter text by pressing **A**, **B** or **C** on the remote control unit.

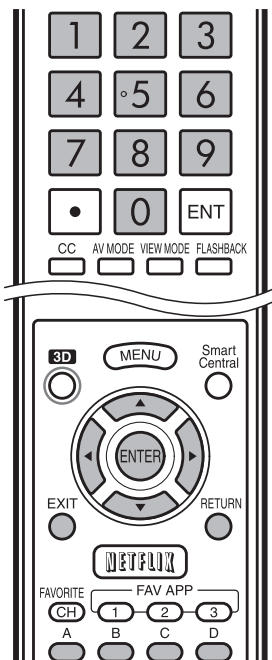

Buttons	Description
	Moves the focus up. When the focus is at the top edge, this moves the focus to the opposite edge (bottom edge).
	Moves the focus down. When the focus is at the bottom edge, this moves the focus to the opposite edge (top edge).
	Moves the focus left. When the focus is at the left edge, this moves the focus to the opposite edge (right edge). When the focus is on "Character Set", this selects the character type (moving backwards). When the focus is in an input box, this moves the cursor in the input box to the left.
	Moves the focus right. When the focus is at the right edge, this moves the focus to the opposite edge (left edge). When the focus is on "Character Set", this selects the character type (moving forwards). When the focus is in an input box, this moves the cursor in the input box to the right.
ENTER	Performs the processing for the button currently in the focus.
EXIT	Closes the software keyboard without applying the original input elements for the entered text. Erases the text in the input box where the cursor is currently located.
RETURN	When the cursor is at the end of a sentence, this acts as a backspace.
0-9	Directly enters the single-byte number for that button.
A (red)	Directly enters prediction candidate 1.
B (green)	Directly enters prediction candidate 2.
C (blue)	Directly enters prediction candidate 3.
D (yellow)	Enters a space.

Caps Off/Caps On/Caps Lock

If "alphabet" is selected in "Character Set", this switches characters between uppercase and lowercase.

Each time you press **ENTER**, the character type switches as shown below:

Caps Off: all the characters are lowercased

Caps On: only the first character is uppercased

Caps Lock: all the characters are uppercased

Done

Applies the entered information and closes the software keyboard.

Quit

Closes the software keyboard without applying the entered information.

- You can also close the software keyboard by pressing **EXIT** on the remote control unit.



Displays the icon "", indicating that a new line has been inserted.

Clear

Erases the character string.

- When the cursor is somewhere in a line: the character string to the right of the cursor will be erased.
- When the cursor is at the right end of a line: the entire line will be erased.

Delete

If the cursor is at the right end of a line, this erases text one character at a time.

- You can also delete text by pressing **RETURN** on the remote control unit.

Using the Browser

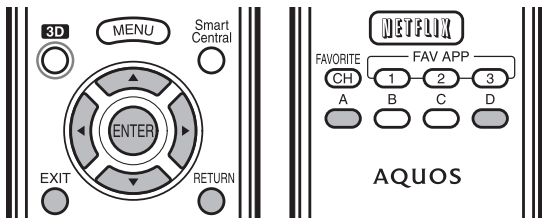

ENTER, ▲/▼/◀/▶

- Press ▲/▼/◀/▶ to select a link that you want to jump, and then press **ENTER**.

EXIT

- Press the button to return to the TV screen.

RETURN

- Press the button to return to the previous page.

D

- Display the toolbar.



Pages with security protection are clearly shown as such.

If content on a page is continued on another page, you can use ▲/▼/◀/▶ to go to the continuation of a page.

- Where there is link text or a link image in the direction pressed, the text or image is selected first. If this happens, press the same direction button several times.

Tool bar

Selected item	Description
◀	Go back to the previous page.
▶	Go to the next page.
↻	Refresh the page. Interrupt a page while it is loading.
★ ★ ★	Display the bookmarks list.
🏠	Display the AQUOS ADVANTAGE LIVE.
🔧	Display the Browser menu.
★	Add the current page to your bookmarks.

About links

- Web pages on the Internet often include “links” that allow you to jump to other web pages (or sites).
- “Links” can take various forms, including words or images, but they always work in the same way letting you jump to the link destination when you select them.
- Selected items (such as links of text input fields) are enclosed in a frame.
- You can jump from a “link” to the corresponding link destination.

DISCLAIMERS

SHARP corporation bears no responsibility regarding the content and quality of the content provided by the content serve provider.

CAUTION

- If the power is cut due to a power failure or the TV being unplugged while you are using the Internet, information such as bookmarks or cookies may not be saved correctly.

NOTE

When a security notification window is displayed:

- Press **ENTER** to close the window.
- This window appears when you visit a web page that has security protection, or when you move from a protected page to an unprotected page.
- In “Security” you can set whether or not this window is displayed. (See page 71.)

To users who access the Internet from a PC

- When you access the Internet from this TV, the procedures may not be the same as regular browser-based access on a PC.
- You cannot download files.
- You cannot view a history of the pages you have visited.
- You cannot change the startup page displayed when you start AQUOS ADVANTAGE LIVE.
- If a pop-up window has appeared as a new page, select “◀” on the toolbar and you can return to the previous page.
- On some pages, video and audio, text or images may not be displayed correctly.

powered
by  espial

<http://www.espial.com>

Using the Internet

Using the Toolbar

You can use the toolbar to control the browser and to specify settings.

- 1 Press **D** to display the toolbar.
- 2 Press **◀/▶** to select a function, and then press **ENTER**.

Saving the URL of the Current Page

Adding a web page to your bookmarks allows you to return to that page later by simply selecting it from your list of bookmarks.

- 1 Display the page that you want to bookmark.
- 2 Press **D** to display the toolbar.
- 3 Press **◀/▶** to select “★” in the toolbar, and then press **ENTER**.
- 4 Select “Yes”, and then press **ENTER**.
 - The page is added to your bookmarks.

Opening a Bookmarked Page

- 1 Press **D** to display the toolbar.
- 2 Press **◀/▶** to select “☆☆” in the toolbar, and then press **ENTER**.
 - Your bookmarks list is displayed.
- 3 Press **▲/▼/◀/▶** to select the page you want to access, and then press **ENTER**.
 - The selected page is displayed.

NOTE

- You can edit and delete bookmarks.

Browsing Web Contents

You can display the web content you want to enjoy.

- 1 Press **D** to display the toolbar.
- 2 Press **◀/▶** to move to the address area in the toolbar, and then press **ENTER**.
 - The Enter Address menu is displayed.
- 3 Enter an address and select “▶”, and then press **ENTER**.
 - The web content you want to view is displayed.

Browser Settings

You can check or modify your browser settings from the Browser menu.

- 1 Press **D** to display the toolbar.
- 2 Press **◀/▶** to select “⚙” in the toolbar, and then press **ENTER**.
- 3 Press **▲/▼** to select and confirm the item you want to set.
- 4 Press **▲/▼/◀/▶** to specify the required setting, and then press **ENTER**.
- 5 Press **D** to exit.

Zoom In/Out:

Zoom in: Displays content enlarged to 200%.

Normal: Displays content at 100%.

Zoom out: Displays content reduced to 75%.

Encoding: Selects the desired encoding from the list below:

Western (ISO-8859-1)/Unicode (UTF-8)

Page Information: Displays information about the currently displayed page.

Security:

Notify me of secure/non-secure page changes:

If you select this option, a message is displayed when you move between a protected page and an unprotected page.

Root Certificates/CA Certificates: Displays the list of certificates. You can choose to enable/disable a certificate.

- Disabled certificates are shown unticked in the certificate list screen.

Cookies:

Accept all: Select this option to accept all cookies.

Reject all: Select this option when you do not want to accept cookies.

Delete All Cookies: Deletes all your cookies.

Reset:

Resets the browser settings.

NOTE

- “Reset” does not reset the certification enable/disable and Encoding settings.

Using the Internet

Using Applications via the Internet

By connecting the TV to the Internet, you can enjoy a variety of broadband content, including videos, music and photos.

Please check that the most current software is loaded on TV by selecting "Auto Update Setting" on "Software Update" (see page 40) or by visiting <http://www.sharpusa.com/products/support/> to check for a download of the newest software version.

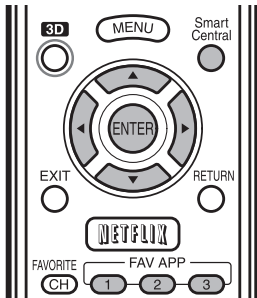

Use the application window to access your favorite Internet applications. Press **SmartCentral** to display the application window.

Follow the on-screen instructions for each application.

- When using this TV to access an Internet application for the first time, the Disclaimer appears on the screen. Press **▲/▼** to select "Agree", and then press **ENTER**. (You must select "Agree" to use the application.)
- Check the web site of the provider for details on setup and use of the functions.

NOTE

- If "X" or "X" is displayed after you connect to the Internet, check your TV's network settings and connection.
- Additional applications will be available in the future.
- These applications are provided by content providers. The available applications vary depending on your country or region.
- The delivery speed of applications varies depending on the network speed. Check the web site of the provider for details on application setup and other information.

Using the Application Window

During Dock Display

You can move the application icons and delete any unused icons.

Example



- Select an application, and then press **▲**.
- Press **▲/▼** to select "Move App" or "Delete App", and then press **ENTER**.

Move the Icons

You can move the icons of the more commonly used applications closer to the left.

Press **◀/▶** to move the icon to the desired location.

Delete an Application

Select "Delete App" to delete the icon.

Saving Favorite Applications

You can set your favorite applications to the **FAV APP 1, 2, and 3** buttons on the remote control for easier startup.

The applications whose icons are moved onto ①, ② and ③ during Dock Display will be assigned to the **FAV APP 1, 2 and 3** buttons respectively.

NOTE

- The SmartCentral icon cannot be moved or deleted.

During Gallery Display

During Dock display, press **SmartCentral** again to display a list of applications by category.

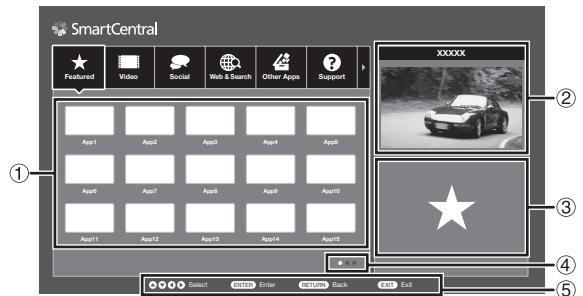

- Press **◀/▶** to select a category, and then press **ENTER** or **▼**.
- Press **▲/▼/◀/▶** to select an application, and then press **ENTER**.
 - Displays a list of applications for the selected category that can be displayed on the TV. Press **ENTER** to add or delete applications to or from the application window and favorites.
 - Displays the image now playing.
 - Provides a description of the selected application.
 - Displayed when there are multiple pages. Press **◀/▶** to change pages.
 - Guide display of required operation buttons.

Example

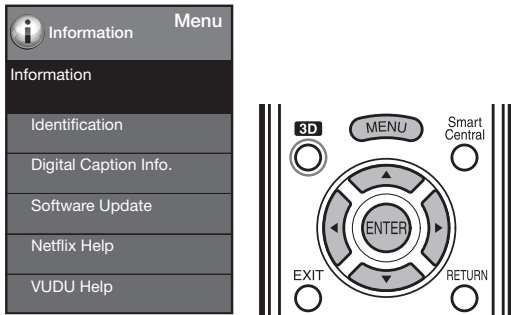

Deactivating Netflix Function

- 1 Press **MENU** to display the menu screen.
- 2 Press **◀/▶** to select "Information", and then press **ENTER**.
- 3 Press **▲/▼** to select "Netflix Help", and then press **ENTER**.
- 4 Press **◀/▶** to select "Deactivate", and then press **ENTER**.
 - To confirm the Netflix status, check the information displayed on the screen and click "OK".

Deactivating the VUDU Function

- 1 Press **MENU** to display the menu screen.
- 2 Press **◀/▶** to select "Information", and then press **ENTER**.
- 3 Press **▲/▼** to select "VUDU Help", and then press **ENTER**.
- 4 Press **◀/▶** to select "Yes", and then press **ENTER**.

Enjoying Skype™

With Skype™ on your TV, you can enjoy large screen video calls.

NOTE

- It is free to create a Skype account and make Skype-to-Skype voice and video calls.
- Skype is not a replacement for your telephone and cannot be used for emergency calls.
- For detailed Skype information, please visit the following website:
<http://www.skype.com/>
- Calling phones and mobiles, sending SMS (short message service) mail and saving instant messages are not possible.
- You might not be able to enjoy Skype on the TV while using a specific function. In such cases, stop using the function.
- Depending on the Skype version being used by the contact you are calling, you may not be able to perform some operations.
- Before using Skype, check "Terms of Use". (See page 77.)

Preparation

To use Skype, you must first make sure you have the following:

- A broadband Internet connection
- Communication camera for Skype
- A registered Skype account, or an e-mail address to create a new Skype account

NOTE

- Depending on the network environment used, transmission qualities of voice or pictures may deteriorate.

Buying the communication camera

Follow the guidance found on the website below and purchase a communication camera compatible with Skype.
<http://freetalk.me/product/sharp/>

NOTE

- The Skype FREETALK® Communication camera is not supplied by Sharp.
- Other cameras and webcams are not compatible with your TV.

Getting Started

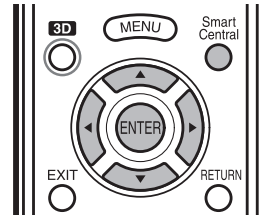

Connecting the Communication Camera

- 1 Connect the communication camera directly to the USB 1 or USB 2 terminal on the TV.

NOTE

- Do not use a USB hub.
- Set the communication camera on the top left of the TV.

Selecting Skype on the Application Window

- 2 Press **SmartCentral** to display the application window.
- 3 Press **Left/Right** to select "Skype", and then press **ENTER**.
 - The Welcome to Skype screen is displayed.
 - When using this TV to access Skype for the first time, the Terms of Use appears on the screen. Press **Up/Down** to select "Agree", and then press **ENTER**. (You must select "Agree" to use the application.)

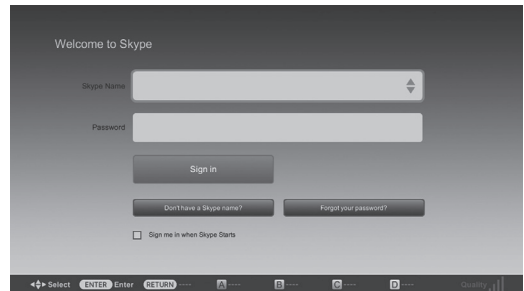

NOTE

- If the Welcome to Skype screen is not displayed, check the network connection.

Creating a New Skype Account

- If you already have a Skype account, you can use that account. (Go to step 8 in **Sign In to Skype**.)
- 4 Select "Don't have a Skype Name?" on the Welcome to Skype screen, and then press **ENTER**.
 - 5 The Create a new Skype account screen will appear. If you agree to all of the terms and conditions, select "Accept", and then press **ENTER**.

NOTE

- For more information on the terms and conditions, refer to the following:
 - Skype Terms of Service (<http://www.skype.com/intl/en/legal/terms/tou>)
 - Skype Privacy Statement (<http://www.skype.com/legal/privacy/general>)

Using the Internet

- 6 Enter your "Full name", "Skype Name", "Password", and "Email" address.

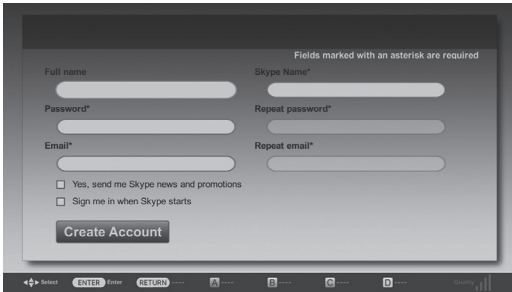

- 7 Select "Create Account", and then press **ENTER**.

Sign In to Skype

- 8 Enter your registered "Skype Name" and "Password".
9 Select "Sign in", and then press **ENTER**.

NOTE

- If you have signed in on the TV before:
 - Select the "Skype Name", and then press **ENTER**.
 - Select your Skype name from the recently used accounts, and then press **ENTER**.
- By ticking the "Sign me in when Skype starts", you can enable automatic sign in.

Using Skype™

Skype Main Menu



- ① Your Skype Name, online status*, Skype credit and profile picture
② The picture from your communication camera
③ Notification area
④ Menu items: "Contacts", "History", "Profile" and "Settings"

* Status icons

Icon	Status
	Online
	Away
	Do not disturb
	Invisible/Offline

Adding Your Friends to Your Contact list

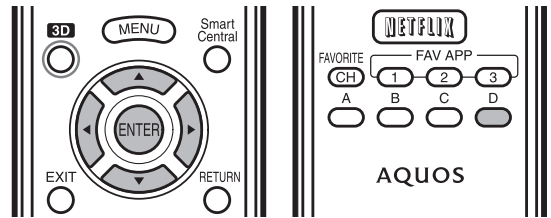

- If this is not your first time using Skype, your previously registered contacts will appear.
- Select "Contacts" on the Skype main menu, and then press **ENTER**.
 - Press **D** (add contact).

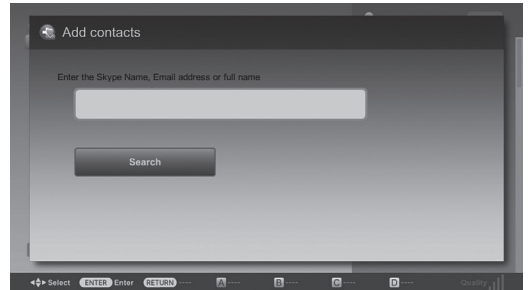

- Enter the Skype name, E-mail address, or full name of the person you want to add.
- Select "Search", and then press **ENTER**.
- Select the person you want to add from the search result, and then press **ENTER**.
- With the software keyboard, enter a message to introduce yourself and send it with "Done".
 - "Contact requests" will be sent to the person added to the Contact list.

Selecting a Contact and Starting a Video Call

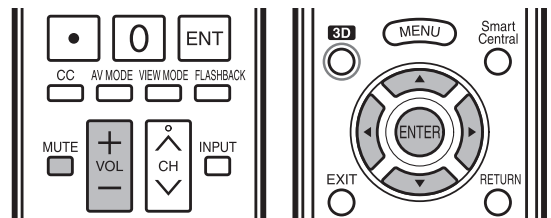

- Select "Contacts" in the Skype main menu, and then press **ENTER**.
- Select a contact who is online from your list of Contacts, and then press **ENTER**.

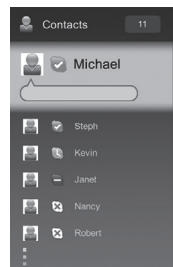

Using the Internet

3 Select "Video call" on the Contacts Option menu, and then press **ENTER**.

- If you want to make a voice call, select "Call".

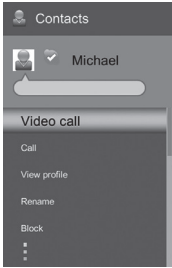

Contact Option menu

Video call: Make a video call.

Call: Make a voice call.

View profile: View the selected contact's profile.

Rename: Rename the selected person.

Block/Unblock: Block/Unblock selected person from contacting you.

Send Voicemail: Send a voicemail message to the selected contact. (Voicemail is a paid service. Visit the following website for more information: <http://www.skype.com/>)

Remove: Remove the person from your Contacts list.

Video Call Screen (Normal View)



- 1 Video call menu*
- 2 The picture from contact person's communication camera
- 3 The picture from your communication camera
- 4 Video quality indicator
(Depending on the network environment)

* Video call menu

Once a video call has started, the following items will be available.

- End call
- Hold/Resume
- Dial pad
- Mute/Unmute (microphone)
- Stop my video/Start my video
- Full view

NOTE

- To change the speaker volume of the unit, press **VOL +/-** or **MUTE** on the remote control.

Receiving Skype Calls

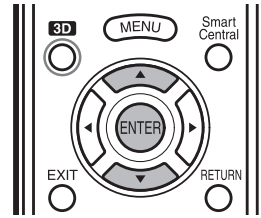

You can receive Skype calls even while watching a TV program or video.

When you receive an incoming call, a window will appear in the bottom right-hand corner of the screen. Select "Video", "Audio", "Decline" or "Hide", and then press **ENTER**.

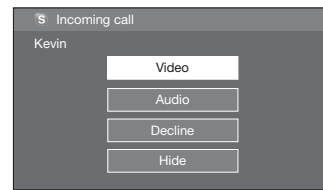

NOTE

- You cannot receive calls when you are signed out of Skype, when the TV is in standby mode, or when the power is off.
- Skype on the TV cannot be activated while you are using a certain specific function. In that case, stop using the function.

Other Useful Functions

On the Skype main menu, you can manage and adjust your call history.

History

- Shows your call history.
- Allows you to call a person displayed in Call History and to accept or block contact requests.

NOTE

- If the time displayed in History is incorrect, make the necessary adjustments in Initial Setup > EZ Setup > Location & Time.

Profile

Set up the following items.

Edit profile: Edit your profile.

Online status: Change your online status.

Settings

Set up the following items.

General settings: Select whether you want to sign in automatically when you enter Skype.

Change password: Change your password.

Video settings: Adjust the privacy settings for video.

Privacy settings: Choose whom you wish to receive calls from.

Block contacts: Set the person who you do not want to hear.

Using the Internet

The following will be displayed when you get access to Skype for the first time.

Terms of Use

PLEASE READ CAREFULLY

1. All Skype features are offered by Skype under the terms of the Skype end user license agreement .
2. You shall not promote, include, display, provide, or make available any content which:
 - (a) may be considered: sexually explicit (including the use of sexual terms, images and nudity);vulgar, profane, offensive or obscene; defamatory, libellous, slanderous; religiously or racially offensive or otherwise promoting hate towards individuals or groups; promoting terrorist or other criminal or illegal activities; promoting gambling, alcohol, tobacco, firearms or ammunition; otherwise unlawful; or
 - (b) infringes anyone else's intellectual property rights, other proprietary rights or rights of privacy; You undertake and represent that you own or have sufficient permission to use all content that you include in, display through, provide, or make available through our product.
3. You are solely responsible for any content that you upload, submit, post, transmit or display through the Skype on our product -(" use" or "used") and that SHARP is not responsible to you or any third party for any content that is used by you or any other Skype user.
4. You will not reverse engineer or attempt to derive the source code for any Skype software included in our product, or remove or separate from our product , or copy, redistribute or otherwise provide to any third parties any Skype software that is included in our product.
5. The Skype features do not support any emergency calls.
6. SHARP will not guarantee that you cannot utilize the Skype features under the following conditions
 - In case the malfunction caused by the Skype server happens
 - In case the malfunction of the network happens
7. IN NO EVENT SHALL SHARP AND/OR ITS AFFILIATES BE LIABLE, WHETHER IN CONTRACT, WARRANTY, TORT (INCLUDING NEGLIGENCE), PRODUCT LIABILITY OR ANY OTHER FORM OF LIABILITY, FOR:
 - SPECIAL OR CONSEQUENTIAL DAMAGES (INCLUDING WITHOUT LIMITATION ANY LOSS OF OR CORRUPTION TO DATA, INTERRUPTION, COMPUTER FAILURE OR PECUNIARY LOSS) ARISING OUT OF THE USE OR INABILITY TO USE THE SKYPE; AND
 - ANY LOSS OF INCOME, BUSINESS OR PROFITS (WHETHER DIRECT OR INDIRECT) ARISING OUT OF THE USE OR INABILITY TO USE THE SKYPE;
 - ANY LOSS OR DAMAGE WHICH MAY BE INCURRED BY YOU AS A RESULT OF;
 - ▶ ANY DISRUPTIONS OR DELAYS IN ANY COMMUNICATION WHEN USING THE SKYPE
8. These Terms of Use supplement and do not replace, any terms, conditions or disclaimers, which were provided with your purchase of the product. All such terms, conditions and disclaimers remain in full force and effect.
9. Your use of the Skype on our product constitutes your agreement to be bound by these Terms of Use. You understand and agree that SHARP will treat your use of the Skype on our product as acceptance of the Terms of Use from that point onwards.

You agree that the use of the Skype on our product is at your own risk.

Using the Internet

When you access the Internet application for the first time, the following appears.

- This message is available only in English.

DISCLAIMERS

- This SHARP device facilitates the access to content and services provided by third parties. The content and services accessible via this device belong to and may be proprietary to third parties. Therefore, any use of such third party content and services must be in accordance with any authorization or terms of use provided by such content or service provider. SHARP shall not be liable to you or any third party for your failure to abide by such authorization or terms of use. Unless otherwise specifically authorized by the applicable content or service provider, all third party content and services provided are for personal and non-commercial use; you may not modify, copy, distribute, transmit, display, perform, reproduce, upload, publish, license, create derivative works from, transfer or sell in any manner or medium any content or services available via this device.
- SHARP is not responsible, nor liable, for customer service-related issues related to the third party content or services. Any questions, comments or service-related inquiries relating to the third party content or service should be made directly to the applicable content or service provider.
You may not be able to access content or services from the device for a variety of reasons which may be unrelated to the device itself, including, but not limited to, power failure, other Internet connection, or failure to configure your device properly. SHARP, its directors, officers, employees, agents, contractors and affiliates shall not be liable to you or any third party with respect to such failures or maintenance outages, regardless of cause or whether or not it could have been avoided.
- ALL THIRD PARTY CONTENT OR SERVICES ACCESSIBLE VIA THIS DEVICE IS PROVIDED TO YOU ON AN "AS-IS" AND "AS AVAILABLE" BASIS AND SHARP AND ITS AFFILIATES MAKE NO WARRANTY OR REPRESENTATION OF ANY KIND TO YOU, EITHER EXPRESS OR IMPLIED, INCLUDING, WITHOUT LIMITATION, ANY WARRANTIES OF MERCHANTABILITY, NON-INFRINGEMENT, FITNESS FOR A PARTICULAR PURPOSE OR ANY WARRANTIES OF SUITABILITY, AVAILABILITY, ACCURACY, COMPLETENESS, SECURITY, TITLE, USEFULNESS, LACK OF NEGLIGENCE OR ERROR-FREE OR UNINTERRUPTED OPERATION OR USE OF THE CONTENT OR SERVICES PROVIDED TO YOU OR THAT THE CONTENT OR SERVICES WILL MEET YOUR REQUIREMENTS OR EXPECTATIONS.
- SHARP IS NOT AN AGENT OF AND ASSUMES NO RESPONSIBILITY FOR THE ACTS OR OMISSIONS OF THIRD PARTY CONTENT OR SERVICE PROVIDERS, NOR ANY ASPECT OF THE CONTENT OR SERVICE RELATED TO SUCH THIRD PARTY PROVIDERS.
- IN NO EVENT WILL SHARP AND/OR ITS AFFILIATES BE LIABLE TO YOU OR ANY THIRD PARTY FOR ANY DIRECT, INDIRECT, SPECIAL, INCIDENTAL, PUNITIVE, CONSEQUENTIAL OR OTHER DAMAGES, WHETHER THE THEORY OF LIABILITY IS BASED ON CONTRACT, TORT, NEGLIGENCE, BREACH OF WARRANTY, STRICT LIABILITY OR OTHERWISE AND WHETHER OR NOT SHARP AND/OR ITS AFFILIATES HAVE BEEN ADVISED OF THE POSSIBILITY OF SUCH DAMAGES.

Examples of Application Logos



Appendix

Removing the Stand

- Before detaching (or attaching) the stand, make sure to turn off the TV and unplug the AC cord.

CAUTION

- Do not remove the stand from the TV unless using an optional wall mount bracket to mount it.

■ LC-70LE845U

- 1** Loosen the screws used to secure the stand cover.

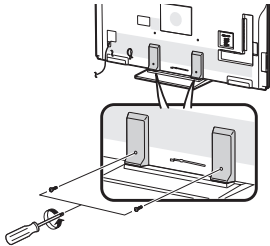

- 2** ① Pull the bottom of the stand cover slightly toward you to allow it to move upward.
② Move the stand cover upward, and pull it toward you to remove.

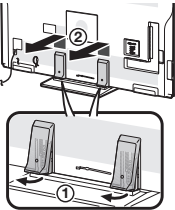

- 3** Unfasten the four screws used to secure the stand in place.

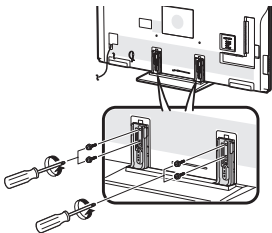

- 4** Detach the stand from the TV.

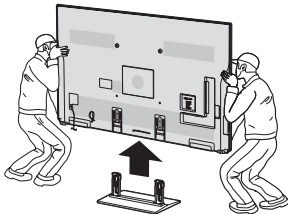

■ LC-60LE845U

- 1** ① Loosen the screws used to secure the stand cover.
② Remove the cover.

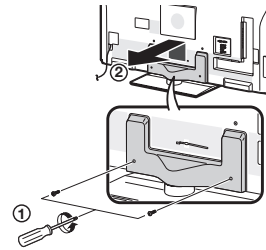

- 2** Unfasten the four screws used to secure the stand in place.

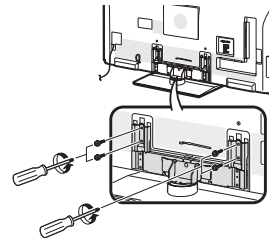

- 3** Detach the stand from the TV.

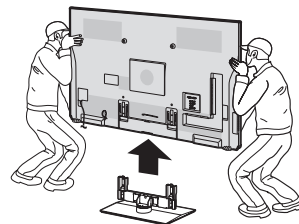

- In the installation procedure, be careful not to catch your fingers between the TV set and the floor.

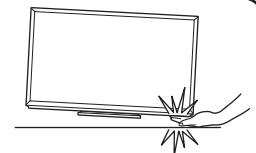

Setting the TV on the Wall

CAUTION

- This TV should be mounted on the wall only with the wall mount bracket AN-52AG4 (SHARP). The use of other wall mount brackets may result in an unstable installation and may cause serious injuries.
- Installing the TV requires special skill that should only be performed by qualified service personnel. Customers should not attempt to do the work themselves. SHARP bears no responsibility for improper mounting or mounting that results in accident or injury.

Using an optional bracket to mount the TV

- You can ask a qualified service professional about using an optional AN-52AG4 bracket to mount the TV on the wall.
- Carefully read the instructions that come with the bracket before beginning work.

Hanging on the wall

AN-52AG4 wall mount bracket.
(See the bracket instructions for details.)

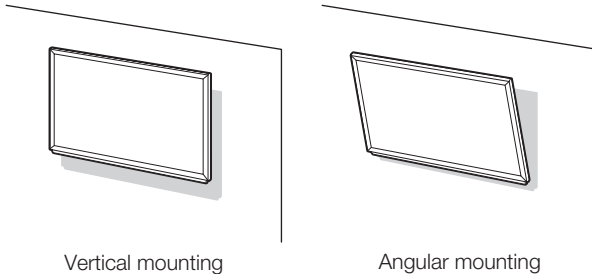

Vertical mounting Angular mounting

About setting the TV angle

AN-52AG4

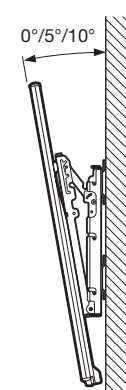

0°/5°/10°

- The "c" position is at the center of the display.
- Refer to the operation manual of AN-52AG4 for details.

NOTE

- Due to the terminal configuration on this TV, when you wall-mount this model, make sure there is enough space between the wall and the TV for the cables.
- To use this TV mounted on a wall, remove the AC cord holder and the covers at the 4 locations on the rear of the TV, and then use the screws supplied with the wall mount bracket to secure the bracket to the rear of the TV.

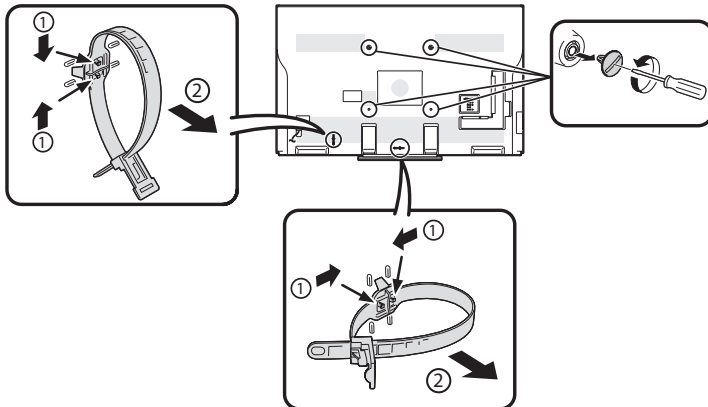

Troubleshooting

Problem	Possible Solution
<ul style="list-style-type: none"> No power 	<ul style="list-style-type: none"> Check if you pressed POWER on the remote control unit. ➔ Page 19 Is the AC cord disconnected? ➔ Page 10 Has the power been turned on? ➔ Page 19
<ul style="list-style-type: none"> Unit cannot be operated. 	<ul style="list-style-type: none"> External influences such as lightning, static electricity, may cause improper operation. In this case, operate the unit after first turning off the power of the TV or unplugging the AC cord and replugging it in after 1 or 2 minutes.
<ul style="list-style-type: none"> Remote control unit does not operate. 	<ul style="list-style-type: none"> Is the equipment to be operated by the remote control unit set correctly? Press TV to set the remote control unit to the setting for operating the TV. Are batteries inserted with polarity (+, -) aligned? ➔ Page 11 Are batteries worn out? (Replace with new batteries.) Are you using it under strong or fluorescent lighting? Is a fluorescent light illuminated near the remote control sensor? Is "RC Control Lock" selected in "Operation Lock Out"? ➔ Page 35
<ul style="list-style-type: none"> Picture is cut off/with sidebar screen. 	<ul style="list-style-type: none"> Is the image position correct? ➔ Pages 34 and 63 Are screen mode adjustments such as picture size made correctly? ➔ Pages 26 and 62
<ul style="list-style-type: none"> Strange color, light color, or color misalignment 	<ul style="list-style-type: none"> Adjust the picture tone. ➔ Pages 29 and 30 Is the room too bright? The picture may look dark in a room that is too bright.
<ul style="list-style-type: none"> Power is suddenly turned off. 	<ul style="list-style-type: none"> Is the sleep timer set? ➔ Page 23 Check the power control settings. ➔ Page 32 The unit's internal temperature has increased. Remove any objects blocking vent or clean.
<ul style="list-style-type: none"> No sound 	<ul style="list-style-type: none"> Is connection to other components correct? ➔ Pages 14 to 18 and 57 Is the volume too low? ➔ Page 23 Is "Variable" selected in "Output Select"? ➔ Page 34 Have you pressed MUTE on the remote control unit? ➔ Page 23 Check the audio output of the connected external equipment. Is the volume too low or muted? When external equipment is connected via an HDMI cable, you may need to configure the audio to be output through the HDMI cable. When audio is not output from external equipment connected to the PC IN or HDMI 2 terminal, check the "Audio Select" setting. ➔ Page 63 Even when external equipment is connected using an HDMI-certified cable, an audio cable connection may be required depending on the type of equipment and the media being played back. In this case, in addition to connecting an HDMI-certified cable to the HDMI 2 terminal, connect a Ø 3.5 mm stereo minijack cable to the AUDIO IN terminal and set "Audio Select" to "HDMI+Analog". ➔ Page 63 When connecting a PC via an HDMI-certified cable, check the following: <ul style="list-style-type: none"> Is the audio output of the PC configured correctly? Check the audio output settings and output audio format in Sound Properties on the PC. The audio formats compatible with this TV are PCM, Dolby Digital. With other formats, audio cannot be output. Depending on the board, only video signals may be output. In this case, in addition to connecting an HDMI-certified cable to the HDMI 2 terminal, connect a Ø 3.5 mm stereo minijack cable to the AUDIO IN terminal and set "Audio Select" to "HDMI+Analog". ➔ Page 63 If you are using a DVI-HDMI conversion cable to connect external equipment to the TV, check the following: <ul style="list-style-type: none"> Is an audio cable connected? The DVI-HDMI conversion cable is for video only. Connect a Ø 3.5 mm stereo minijack cable to listen to the audio. Is HDMI 2 being used? When the TV is connected to another HDMI terminal, the audio and video are not output together even if a Ø 3.5 mm stereo minijack cable is connected to the shared AUDIO IN terminal for PC IN and HDMI 2. Check the "Audio Select" setting. Set "Audio Select" to "HDMI+Analog". ➔ Page 63

Appendix

Problem	Possible Solution
<ul style="list-style-type: none"> No picture 	<ul style="list-style-type: none"> Is connection to other components correct? ➔ Pages 14 to 18 and 57 Is the correct input selected? ➔ Pages 14 and 23 Is "On" selected in "Audio Only"? ➔ Page 32 If the PC image is not displayed, check the following: <ul style="list-style-type: none"> When connecting a laptop PC to the TV, check that display output mode of the PC is set to external monitor. Check the resolution setting on the PC. Is a non-compatible signal being input? ➔ Page 63
<ul style="list-style-type: none"> Picture quality of HD programs is poor. 	<ul style="list-style-type: none"> To enjoy HD images from external equipment, you are required to set up HDMI connection or component connection. If the program content is not of HD quality, HD images cannot be displayed. Check that the program you are viewing provides HD images. The HD cable/satellite set-top box may need to be configured to output HD images via cable/satellite. The cable/satellite broadcast may not support a signal resolution of 1080p.
<ul style="list-style-type: none"> The TV sometimes makes a cracking sound. 	<ul style="list-style-type: none"> This is not a malfunction. This happens when the cabinet slightly expands and contracts according to change in temperature. This does not affect the TV's performance.
<ul style="list-style-type: none"> The AQUOS ADVANTAGE LIVE cannot be displayed. 	<ul style="list-style-type: none"> Is the ETHERNET cable connected correctly? ➔ Page 66 Check the settings of "Internet Setup". ➔ Pages 67 to 68
<ul style="list-style-type: none"> Some Internet functions used on a PC are not available from the TV. 	<ul style="list-style-type: none"> The TV has only limited functions compared with regular PC browsers. ➔ Page 70

Troubleshooting - 3D Images

Problem	Possible Solution
<ul style="list-style-type: none"> 3D images are not displayed. 	<ul style="list-style-type: none"> Is "3D Auto Change" set to "Off"? Press 3D to switch to 3D mode. ➔ Page 46 If "3D Auto Change" is set to "Mode 1" or "Mode 2" but no 3D images are displayed, check the display format of the content being viewed. Some 3D image signals may not be recognized as 3D images automatically. Press 3D to select the appropriate display format for the 3D image. ➔ Pages 44 to 45 Is the power of the 3D Glasses turned on? Are the 3D Glasses set to 2D mode? Is there an obstacle between the 3D Glasses and the TV, or is something covering the infrared receiver on the 3D Glasses? The 3D Glasses operate by receiving a signal from the TV. Do not place anything between the 3D infrared emitter on the TV and the infrared receiver on the 3D Glasses. ➔ Page 12

For further details, refer to the operation manual of your 3D Glasses.

Troubleshooting - Error Message

The example of an error message displayed on a screen	Error code	Possible Solution
<ul style="list-style-type: none"> Failed to receive broadcast. 	E202	<ul style="list-style-type: none"> Check the antenna cable. Check that the antenna is correctly setup.
<ul style="list-style-type: none"> No broadcast now. 	E203	<ul style="list-style-type: none"> Check the broadcast time in the program guide.
<ul style="list-style-type: none"> An incompatible audio signal has been received. Check the output device settings. 	—	<ul style="list-style-type: none"> This message is displayed when an audio format other than PCM or Dolby Digital is input. (The DTS audio format is not supported.) <ul style="list-style-type: none"> Set the audio output format of connected external HDMI equipment to PCM or Dolby Digital. Refer to the operation manual of the external equipment for setting details.

Trademarks

• SmartCentral is a registered trademark of Sharp Corporation

• Products that have earned the ENERGY STAR® are designed to protect the environment through superior energy efficiency.

• Manufactured under license from Dolby Laboratories. Dolby and the double-D symbol are trademarks of Dolby Laboratories.

• "HDMI, the HDMI logo and High-Definition Multimedia Interface are trademarks or registered trademarks of HDMI Licensing LLC in the United States and other countries."

• DivX®, DivX Certified®, DivX Plus® HD and associated logos are trademarks of Rovi Corporation or its subsidiaries and are used under license.

• The Wi-Fi CERTIFIED Logo is a certification mark of the Wi-Fi Alliance.
• The Wi-Fi Protected Setup Mark is a mark of the Wi-Fi Alliance.

• DLNA®, the DLNA Logo and DLNA CERTIFIED™ are trademarks, service marks, or certification marks of the Digital Living Network Alliance.

• This product includes DLNA Software 'DiXiM' developed by DigiOn, Inc.

• LC フォント、LC FONT、エルシーフォント and LC logo mark are registered trademarks of SHARP Corporation. This product is embedded with LC Font technology, which was developed by SHARP Corporation for clearly displaying easy-to-read characters on LCD screens. However, other fonts are used for some screen pages, too.

• "x.v.Color" and **x.v.Color** are trademarks of Sony Corporation.

• ABOUT DIVX VIDEO: DivX® is a digital video format created by DivX, LLC, a subsidiary of Rovi Corporation. This is an official DivX Certified® device that plays DivX video. Visit divx.com for more information and software tools to convert your files into DivX videos.
• ABOUT DIVX VIDEO-ON-DEMAND: This DivX Certified® device must be registered in order to play purchased DivX Video-on-Demand (VOD) movies. To obtain your registration code, locate the DivX VOD section in your device setup menu. Go to vod.divx.com for more information on how to complete your registration.

• Netflix and the Netflix logo are the registered trademarks of Netflix, Inc.

• VUDU™ is a trademark of VUDU, Inc.

• Skype, the Skype Logo and the S logo and other marks indicated on these instructions are trademarks of Skype Limited or other related companies.

Specifications

TV

Item		Model: LC-70LE845U	Model: LC-60LE845U
LCD panel	Size	70" Class (69 1/2" Diagonal)	60" Class (60 1/32" Diagonal)
	Resolution	2,073,600 pixels (1,920 × 1,080)	
TV Function	TV-standard (CCIR)		American TV Standard ATSC/NTSC System
	Receiving Channel	VHF/UHF	VHF 2-13ch, UHF 14-69ch
		CATV	1-135ch (non-scrambled channel only)
		Digital Terrestrial Broadcast (8VSB)	2-69ch
		Digital cable ¹ (64/256 QAM)	1-135ch (non-scrambled channel only)
Audio multiplex		BTSC System	
Audio out		10W × 2 + 15W (WF)	
Terminals	Back panel vertical inputs	HDMI 1	HDMI in with HDCP, ARC
		HDMI 2	HDMI in with HDCP, Audio in (Ø 3.5 mm stereo jack)
		HDMI 3	HDMI in with HDCP
		HDMI 4	HDMI in with HDCP, MHL
		AUDIO OUT	Audio out (Ø 3.5 mm stereo jack)
		USB 1	Photo/Music/Video mode, Software update
	Back panel surface inputs	COMPONENT	COMPONENT in
		VIDEO 1	AV in
		VIDEO 2	AV in
		PC IN	ANALOG RGB (PC) in (15-pin mini D-sub female connector), Audio in (Ø 3.5 mm stereo jack)
	Back panel horizontal inputs	RS-232C	9-pin D-sub male connector
		ANT/CABLE	75 Ω Unbalance, F Type × 1 for Analog (VHF/UHF/CATV) and Digital (AIR/CABLE)
		AUDIO IN	Audio in (Ø 3.5 mm stereo jack)
		DIGITAL AUDIO OUTPUT	Optical Digital audio output × 1 (PCM/Dolby Digital)
		ETHERNET	Network connector
USB 2	Photo/Music/Video mode, Software update		
OSD language		English/French/Spanish	
Power Requirement		AC 120 V, 60 Hz	
Power Consumption		200 W (0.1 W Standby with AC 120 V)	170 W (0.1 W Standby with AC 120 V)
Weight	TV + stand	90.4 lbs./41.0 kg	76.1 lbs./34.5 kg
	TV only	83.8 lbs./38.0 kg	60.6 lbs./27.5 kg
Dimensions ² (W × H × D)	TV + stand	62 49/64 × 39 11/32 × 14 7/32 inches	54 47/64 × 34 59/64 × 14 27/64 inches
	TV only	62 49/64 × 38 × 2 13/64 inches	54 47/64 × 33 × 2 11/64 inches
Operating temperature		+ 32°F to + 104°F (0°C to + 40°C)	

¹ Emergency alert messages via Cable are unreceivable.

² The dimensional drawings are shown on the inside back cover.

- As part of policy of continuous improvement, SHARP reserves the right to make design and specification changes for product improvement without prior notice. The performance specification figures indicated are nominal values of production units. There may be some deviations from these values in individual units.

Cautions regarding use in high and low temperature environments

- When the unit is used in a low temperature space (e.g. room, office), the picture may leave trails or appear slightly delayed. This is not a malfunction, and the unit will recover when the temperature returns to normal.
- Do not leave the unit in a hot or cold location. Also, do not leave the unit in a location exposed to direct sunlight or near a heater, as this may cause the cabinet to deform and the front panel to malfunction.
Storage temperature: - 4°F to + 140°F (- 20°C to + 60°C)

Specifications

Wireless LAN

This TV has received the following certifications.

- Wi-Fi CERTIFIED™ (certification program from the Wi-Fi Alliance®)
- Wi-Fi Protected Setup™ (certification program from the Wi-Fi Alliance®)

FCC

This device complies with part 15 of the FCC Rules. Operation is subject to the following two conditions:

(1) This device may not cause harmful interference, and (2) this device must accept any interference received, including interference that may cause undesired operation. Changes or modifications not expressly approved by the party responsible for compliance could void the user's authority to operate the equipment. To comply with the FCC RF exposure compliance requirements, this device and its antenna must not be co-located or operated in conjunction with any other antenna or transmitter.

The device for the band 5150-5250 MHz is only for indoor usage to reduce potential for harmful interference to co-channel mobile satellite systems;

The maximum antenna gain permitted (for devices in the bands 5250-5350 MHz and 5470-5725 MHz) to comply with the e.i.r.p. limit; and High-power radars are allocated as primary users (meaning they have priority) of the bands 5250-5350 MHz and 5650-5850 MHz and these radars could cause interference and/or damage to LE-LAN devices.

COFETEL

This equipment operates on a secondary basis and, consequently, must accept harmful interference, including from station of the same kind, and may not cause harmful interference to systems operating on a primary basis.

CONTAINS TRANSMITTER MODULE COFETEL ID: RCPSTW11-1252

Brand: SHARP

Model: TWFM-B005D

Specification	
Standard	IEEE 802.11a/b/g/n
Frequency Band	2412-2484 MHz 5150-5850 MHz
Security	Static WEP (64/128 bit key Index 1 only) WPA-PSK (TKIP) WPA2-PSK (AES)
Modulation	DBPSK@1Mbps DQPSK@2Mbps CCK@5.5/11Mbps BPSK@6/9 Mbps QPSK@12/18Mbps 16-QAM@24Mbps 64-QAM@48/54Mbps and above, Rx up to 300Mbps

CLEARING THE SECRET NUMBER

If you forget the secret number, clear the secret number using the following procedure.

- 1 Select an item from the list below to display the secret number input screen. (For operating the on-screen display menu, see page 27.)
 - "Color system" (← "Terminal Setting" ← System Options menu).
 - "EZ Setup" or "Reset" (← Initial Setup menu).
 - "CH Setup" (← "Broadcasting Setup" ← Initial Setup menu).
 - "Parental CTRL" (← "Individual Setup" ← Initial Setup menu).
 - "Interactive Service" (← "Internet Setup" ← Initial Setup menu).
 - "Software Update" (← Information menu).
- 2 Press and hold both **CH** and **VOL+** on the TV simultaneously until the message appears on the screen.

The secret number is

--	--	--	--	--

NOTE

- As a precautionary measure, make a note of your secret number above, and keep it in a safe place.

Information on the Software License for This Product

■ Software composition

The software included in this product is comprised of various software components whose individual copyrights are held by SHARP or by third parties.

■ Software developed by SHARP and open source software

The copyrights for the software components and various relevant documents included with this product that were developed or written by SHARP are owned by SHARP and are protected by the Copyright Act, international treaties, and other relevant laws. This product also makes use of freely distributed software and software components whose copyrights are held by third parties. These include software components covered by a GNU General Public License (hereafter GPL), a GNU Lesser General Public License (hereafter LGPL) or other license agreement.

■ Obtaining source code

Some of the open source software licensors require the distributor to provide the source code with the executable software components. GPL and LGPL include similar requirements. For information on obtaining the source code for the open source software and for obtaining the GPL, LGPL, and other license agreement information, visit the following website:

<http://www.sharpusa.com/gpl>

We are unable to answer any questions about the source code for the open source software. The source code for the software components whose copyrights are held by SHARP is not distributed.

■ Acknowledgements

The following are some of the open source software components included in this product:

- linux kernel/busybox/glibc/zlib/libpng/libjpeg/libiconv/DirectFB/OpenSSL/XMLRPC-EPI/mtd-utils/Expat/Qt/U-Boot/PlayReady/AGG(ver2.3)/device-mapper/libfreetype/cURL/libxml2/luas/luasrc/luasrc-crypto/Ffmpeg/SQLite/libzip/c-ares/librt/libjanus/NTP/webkit/cairo/fontconfig/icu/libxslt/gtk+/atk/pango/glib2/libpixman

For the complete list, please see the URL above.

■ Software Copyrights

XMLRPC-EPI

Copyright 2000 © Epinions, Inc.

libjpeg

This software is copyright © 1991-1998, Thomas G. Lane.

Portions of this software are based in part on the work of the Independent JPEG Group.

SSLeay

Copyright © 1995-1998 Eric Young (eay@cryptsoft.com)

This product includes cryptographic software written by Eric Young (eay@cryptsoft.com).

Expat

Copyright © 1998, 1999, 2000 Thai Open Source Software Center Ltd and Clark Cooper.

Copyright © 2001, 2002, 2003, 2004, 2005, 2006 Expat maintainers.

Qt

The Qt GUI Toolkit is Copyright © 2010 Nokia Corporation and/or its subsidiary(-ies).

Contact: Nokia Corporation (qt-info@nokia.com)

PlayReady

This product contains technology subject to certain intellectual property rights of Microsoft. Use or distribution of this technology outside of this product is prohibited without the appropriate license(s) from Microsoft.

Content owners use Microsoft PlayReady™ content access technology to protect their intellectual property, including copyrighted content. This device uses PlayReady technology to access PlayReady-protected content and/or WMDRM-protected content. If the device fails to properly enforce restrictions on content usage, content owners may require Microsoft to revoke the device's ability to consume PlayReady-protected content. Revocation should not affect unprotected content or content protected by other content access technologies. Content owners may require you to upgrade PlayReady to access their content. If you decline an upgrade, you will not be able to access content that requires the upgrade.

libfreetype

Copyright © 2006, 2007, 2008, 2009, 2010 by David Turner, Robert Wilhelm, and Werner Lemberg.

libxml2

Copyright © 1998-2003 Daniel Veillard. All Rights Reserved.

Lua

Copyright © 1994-2008 Lua.org, PUC-Rio

Lua-xmlreader

Copyright © 2008 A.S. Bradbury

Lua-sncrypto

Copyright © 2005 Malete Partner, Berlin, partner@malete.org

Information on the Software License for This Product

- libzip Copyright © Guido Draheim guidod@gmx.de
- c-ares Copyright © 1998 by the Massachusetts Institute of Technology.
- Group 42 Portions copyright © 2000 Group 42, Inc. and the Contributing Authors.
- zlib Portions copyright © 1995-1996 Jean-loup Gailly and Mark Adler.
- RSA Data Security
MD5.CPP - RSA Data Security, Inc., MD5 message-digest algorithm. Copyright © 1991-2, RSA Data Security, Inc. Created 1991. All rights reserved.
- Fraunhofer IIS and Thomson Multimedia
MPEG Layer-3 audio compression technology licensed by Fraunhofer IIS and Thomson Multimedia. You cannot use the MP3 compressed audio within the Software for real time or live broadcasts. If you require an MP3 decoder for real time or live broadcasts, you are responsible for obtaining this MP3 technology license.
- Nellymoser, Inc
Speech compression and decompression technology licensed by Nellymoser, Inc.
- Sorenson Media, Inc
Sorenson™ Spark™ video compression and decompression technology licensed from Sorenson Media, Inc.
- Sun Microsystems, Inc
ADPCM speech compression algorithm is used with the permission of Sun Microsystems, Inc.
- NTP
Copyright © University of Delaware 1992-2011
Permission to use, copy, modify, and distribute this software and its documentation for any purpose with or without fee is hereby granted, provided that the above copyright notice appears in all copies and that both the copyright notice and this permission notice appear in supporting documentation, and that the name University of Delaware not be used in advertising or publicity pertaining to distribution of the software without specific, written prior permission. The University of Delaware makes no representations about the suitability this software for any purpose. It is provided "as is" without express or implied warranty.
- fontconfig Copyright © 2001, 2003 Keith Packard
- icu Copyright © 1995-2011 International Business Machines Corporation and others All rights reserved.
- libxslt Copyright © 2001-2002 Daniel Veillard. All Rights Reserved.
- cURL
COPYRIGHT AND PERMISSION NOTICE
Copyright © 1996-2009, Daniel Stenberg, <daniel@haxx.se>.
All rights reserved.
Permission to use, copy, modify, and distribute this software for any purpose with or without fee is hereby granted, provided that the above copyright notice and this permission notice appear in all copies.
THE SOFTWARE IS PROVIDED "AS IS", WITHOUT WARRANTY OF ANY KIND, EXPRESS OR IMPLIED, INCLUDING BUT NOT LIMITED TO THE WARRANTIES OF MERCHANTABILITY, FITNESS FOR A PARTICULAR PURPOSE AND NONINFRINGEMENT OF THIRD PARTY RIGHTS. IN NO EVENT SHALL THE AUTHORS OR COPYRIGHT HOLDERS BE LIABLE FOR ANY CLAIM, DAMAGES OR OTHER LIABILITY, WHETHER IN AN ACTION OF CONTRACT, TORT OR OTHERWISE, ARISING FROM, OUT OF OR IN CONNECTION WITH THE SOFTWARE OR THE USE OR OTHER DEALINGS IN THE SOFTWARE.
Except as contained in this notice, the name of a copyright holder shall not be used in advertising or otherwise to promote the sale, use or other dealings in this Software without prior written authorization of the copyright holder.
- libpixman Copyright © 2008 Free Software Foundation, Inc.

Information on the Software License for This Product

OpenSSL

LICENSE ISSUES

The OpenSSL toolkit stays under a dual license, i.e. both the conditions of the OpenSSL License and the original SSLeay license apply to the toolkit.

See below for the actual license texts. Actually both licenses are BSD-style Open Source licenses. In case of any license issues related to OpenSSL please contact openssl-core@openssl.org.

OpenSSL License

Copyright © 1998-2008 The OpenSSL Project. All rights reserved.

Redistribution and use in source and binary forms, with or without modification, are permitted provided that the following conditions are met:

1. Redistributions of source code must retain the above copyright notice, this list of conditions and the following disclaimer.
2. Redistributions in binary form must reproduce the above copyright notice, this list of conditions and the following disclaimer in the documentation and/or other materials provided with the distribution.
3. All advertising materials mentioning features or use of this software must display the following acknowledgment: "This product includes software developed by the OpenSSL Project for use in the OpenSSL Toolkit. (<http://www.openssl.org/>)"
4. The names "OpenSSL Toolkit" and "OpenSSL Project" must not be used to endorse or promote products derived from this software without prior written permission. For written permission, please contact openssl-core@openssl.org.
5. Products derived from this software may not be called "OpenSSL" nor may "OpenSSL" appear in their names without prior written permission of the OpenSSL Project.
6. Redistributions of any form whatsoever must retain the following acknowledgment: "This product includes software developed by the OpenSSL Project for use in the OpenSSL Toolkit (<http://www.openssl.org/>)"

THIS SOFTWARE IS PROVIDED BY THE OpenSSL PROJECT "AS IS" AND ANY EXPRESSED OR IMPLIED WARRANTIES, INCLUDING, BUT NOT LIMITED TO, THE IMPLIED WARRANTIES OF MERCHANTABILITY AND FITNESS FOR A PARTICULAR PURPOSE ARE DISCLAIMED. IN NO EVENT SHALL THE OpenSSL PROJECT OR ITS CONTRIBUTORS BE LIABLE FOR ANY DIRECT, INDIRECT, INCIDENTAL, SPECIAL, EXEMPLARY, OR CONSEQUENTIAL DAMAGES (INCLUDING, BUT NOT LIMITED TO, PROCUREMENT OF SUBSTITUTE GOODS OR SERVICES; LOSS OF USE, DATA, OR PROFITS; OR BUSINESS INTERRUPTION) HOWEVER CAUSED AND ON ANY THEORY OF LIABILITY, WHETHER IN CONTRACT, STRICT LIABILITY, OR TORT (INCLUDING NEGLIGENCE OR OTHERWISE) ARISING IN ANY WAY OUT OF THE USE OF THIS SOFTWARE, EVEN IF ADVISED OF THE POSSIBILITY OF SUCH DAMAGE.

This product includes cryptographic software written by Eric Young (eay@cryptsoft.com). This product includes software written by Tim Hudson (tjh@cryptsoft.com).

Original SSLeay License

Copyright © 1995-1998 Eric Young (eay@cryptsoft.com) All rights reserved.

This package is an SSL implementation written by Eric Young (eay@cryptsoft.com).

The implementation was written so as to conform with Netscapes SSL.

This library is free for commercial and non-commercial use as long as the following conditions are adhered to. The following conditions apply to all code found in this distribution, be it the RC4, RSA, lhash, DES, etc., code; not just the SSL code. The SSL documentation included with this distribution is covered by the same copyright terms except that the holder is Tim Hudson (tjh@cryptsoft.com).

Copyright remains Eric Young's, and as such any Copyright notices in the code are not to be removed. If this package is used in a product, Eric Young should be given attribution as the author of the parts of the library used. This can be in the form of a textual message at program startup or in documentation (online or textual) provided with the package.

Redistribution and use in source and binary forms, with or without modification, are permitted provided that the following conditions are met:

1. Redistributions of source code must retain the copyright notice, this list of conditions and the following disclaimer.
 2. Redistributions in binary form must reproduce the above copyright notice, this list of conditions and the following disclaimer in the documentation and/or other materials provided with the distribution.
 3. All advertising materials mentioning features or use of this software must display the following acknowledgement: "This product includes cryptographic software written by Eric Young (eay@cryptsoft.com)"
- The word 'cryptographic' can be left out if the routines from the library being used are not cryptographic related (-).
4. If you include any Windows specific code (or a derivative thereof) from the apps directory (application code) you must include an acknowledgement:

"This product includes software written by Tim Hudson (tjh@cryptsoft.com)"

THIS SOFTWARE IS PROVIDED BY ERIC YOUNG "AS IS" AND ANY EXPRESS OR IMPLIED WARRANTIES, INCLUDING, BUT NOT LIMITED TO, THE IMPLIED WARRANTIES OF MERCHANTABILITY AND FITNESS FOR A PARTICULAR PURPOSE ARE DISCLAIMED. IN NO EVENT SHALL THE AUTHOR OR CONTRIBUTORS BE LIABLE FOR ANY DIRECT, INDIRECT, INCIDENTAL, SPECIAL, EXEMPLARY, OR CONSEQUENTIAL DAMAGES (INCLUDING, BUT NOT LIMITED TO, PROCUREMENT OF SUBSTITUTE GOODS OR SERVICES; LOSS OF USE, DATA, OR PROFITS; OR BUSINESS INTERRUPTION) HOWEVER CAUSED AND ON ANY THEORY OF LIABILITY, WHETHER IN CONTRACT, STRICT LIABILITY, OR TORT (INCLUDING NEGLIGENCE OR OTHERWISE) ARISING IN ANY WAY OUT OF THE USE OF THIS SOFTWARE, EVEN IF ADVISED OF THE POSSIBILITY OF SUCH DAMAGE.

The licence and distribution terms for any publically available version or derivative of this code cannot be changed. i.e. this code cannot simply be copied and put under another distribution licence

[including the GNU Public Licence.]

Calling for Service

For location of the nearest Sharp Authorized Service, or to obtain product literature, accessories, supplies, or customer assistance, please call 1-800-BE-SHARP.

LIMITED WARRANTY

CONSUMER LIMITED WARRANTY

SHARP ELECTRONICS CORPORATION warrants to the first consumer purchaser that this Sharp brand Liquid Crystal Display product (the "Product"), when shipped in its original container, will be free from defective workmanship and materials, and agrees that it will, at its option, either repair the defect or replace the defective Product or part thereof with a new or remanufactured equivalent at no charge to the purchaser for parts or labor for the period(s) set forth below.

This warranty does not apply to any appearance items of the Product or if the serial number or model number affixed to the Product has been removed, defaced, changed, altered or tampered with. This warranty does not cover installation or signal reception problems. This limited warranty will not apply if the Product has been or is being used in a commercial setting or application; this warranty is meant solely for the non-commercial, household use of the Product by consumers in their home or residence. If you intend to or already use this Product for commercial purposes or in a commercial setting, there are warranties available to cover your use of this Product, the terms of which may vary. Please contact **1-888-GO-SHARP** for further information.

In order to enforce your rights under this limited warranty, you should follow the steps set forth below. You must be able to provide proof of purchase to the servicer, which proof must include the date of purchase.

To the extent permitted by applicable state law, the warranties set forth are in lieu of, and exclusive of, all other warranties, express or implied. Specifically ALL OTHER WARRANTIES OTHER THAN THOSE SET FORTH ABOVE ARE EXCLUDED, ALL EXPRESS AND IMPLIED WARRANTIES INCLUDING THE WARRANTIES OF MERCHANTABILITY, FITNESS FOR USE, AND FITNESS FOR A PARTICULAR PURPOSE ARE SPECIFICALLY EXCLUDED. IF, UNDER APPLICABLE STATE LAW, IMPLIED WARRANTIES MAY NOT VALIDLY BE DISCLAIMED OR EXCLUDED, THE DURATION OF SUCH IMPLIED WARRANTIES IS LIMITED TO THE PERIOD(S) FROM THE DATE OF PURCHASE SET FORTH BELOW. THIS WARRANTY GIVES YOU SPECIFIC LEGAL RIGHTS. YOU MAY ALSO HAVE OTHER RIGHTS WHICH VARY FROM STATE TO STATE.

The warranties given herein shall be the sole and exclusive warranties granted by Sharp and shall be the sole and exclusive remedy available to the purchaser and only for the time periods set forth herein. No other representations or promises made by anyone are permitted. Correction of defects, in the manner and for the period of time described herein, shall constitute complete fulfillment of all liabilities and responsibilities of Sharp to the purchaser with respect to the Product, and shall constitute full satisfaction of all claims, whether based on contract, negligence, strict liability or otherwise. Sharp does not warrant nor shall Sharp be liable, or in any way responsible, for Products which have been subject to abuse (including, but not limited to, improper voltage), accident, misuse, negligence, lack of reasonable care, alteration, modification, tampering, misuse, improper operation or maintenance or any damages or defects in the Product which were caused by repairs or attempted repairs performed by anyone other than a Sharp authorized servicer. Nor shall Sharp be liable or in any way responsible for any incidental or consequential economic or property damage. Some states do not allow limits on warranties or on remedies for breach in certain transactions; in such states, the limits herein may not apply.

THIS LIMITED WARRANTY IS VALID ONLY IN THE FIFTY (50) UNITED STATES, THE DISTRICT OF COLUMBIA AND PUERTO RICO.

Model Specific Section

Your Product Model Number & Description:

LC-70LE845U/LC-60LE845U LCD Color Television
(Be sure to have this information available when you need service for your Product.)

Warranty Period for this Product:

One (1) year parts and labor from the date of purchase.

Additional Exclusions from Warranty Coverage (if any):

In order for the Product to be serviced, the Product must be readily available to the servicer, free and clear of any complex or non-standard installation, mounting or other encumbrance which would unreasonably interfere with servicing the Product. The Servicer will remount the Product after service, provided that such remounting is not into a complex or non-standard installation. Any additional labor and materials required to remove and/or reinstall a Product above and beyond the foregoing are not covered by this warranty, may result in additional charges and are the responsibility of the consumer. Image Retention resulting from a fixed image being displayed for long periods of time is not covered by this Limited Warranty (see Operation Manual on how to prevent this).

Where to Obtain Service:

From a Sharp Authorized Servicer located in the United States. To find the location of the nearest Sharp Authorized Servicer, please call Sharp toll free at 1-800-BE-SHARP.

What to do to Obtain Service:

Contact your Sharp Authorized Servicer to obtain in home service for this product. The Servicer will come to your location and if necessary remove the unit for repair at the Servicer's facility and return the set to you once completed. Be sure to have **Proof of Purchase** available.

TO OBTAIN PRODUCT INFORMATION OR PURCHASE ACCESSORIES AND EXTENDED WARRANTIES, CALL **1-800-BE-SHARP** OR VISIT www.sharppusa.com

SHARP®

LIMITED WARRANTY

Consumer Electronics Products

Congratulations on your purchase!

Sharp Electronics of Canada Ltd. ("Sharp") warrants to the first purchaser for this Sharp brand product ("Product"), when shipped in its original container and sold or distributed in Canada by Sharp or by an authorized Sharp dealer, that the Product will during the applicable warranty period, be free from defects in material and workmanship, and will within the applicable warranty period, either repair the defective Product or provide the first purchaser a replacement of the defective Product.

Conditions: This limited warranty shall not apply to:

- (a) Any defects caused or repairs required as a result of abusive operation, negligence, accident, improper installation or inappropriate use as outlined in the owner's manual or other applicable Product documentation.
- (b) Any defects caused or repairs required as a result of any Product that has been tampered with, modified, adjusted or repaired by any person other than Sharp, a Sharp authorized service centre or a Sharp authorized servicing dealer.
- (c) Any defects caused or repairs required as a result of the use of the Product with items not specified or approved by Sharp, including but not limited to, head cleaning tapes and chemical cleaning agents.
- (d) Any replacement of accessories, glassware, consumable or peripheral items required through normal use of the Product, including but not limited to, earphones, remote controls, AC adapters, batteries, temperature probe, trays, filters, belts, ribbons, cables and paper.
- (e) Any cosmetic damage to the Product surface or exterior that has been defaced or caused by normal wear and tear.
- (f) Any defects caused or repairs required as a result of damage caused by any external or environmental conditions, including but not limited to, transmission line/power line voltage or liquid spillage or acts of God.
- (g) Warranty claims for Products returned with illegible or without appropriate model, serial number and CSA/cUL markings.
- (h) Any Products used for rental or commercial purposes.
- (i) Any installation, setup and/or programming charges.

How to get service: Warranty service may be obtained upon delivery of the Product, together with proof of purchase (including date of purchase) and a copy of this limited warranty statement, to an authorized Sharp service centre or an authorized Sharp servicing dealer. In home warranty service may be provided, at Sharp's discretion, on any Sharp Television with the screen size of 40" or larger and on any Sharp Over-The-Range Microwave Oven or Home Use Microwave Drawer. No other person (including any Sharp dealer or service centre) is authorized to extend, enlarge or transfer this warranty on behalf of Sharp. The purchaser will be responsible for any and all removal, reinstallation, transportation and insurance costs incurred.

The express warranties in this limited warranty are, except for consumer purchasers domiciled in Quebec, in lieu of and, except to the extent prohibited by applicable law, Sharp disclaims all other warranties and conditions, express or implied, whether arising by law, statute, by course of dealing or usage of trade, including, without limitation, implied warranties or conditions of merchantability and/or quality, fitness for a particular use or purpose, and/or non-infringement. **Limitations** (not applicable to consumer purchasers domiciled in Quebec to the extent prohibited under Quebec law): (a) Sharp shall not be liable for any incidental, special, consequential, economic, exemplary or indirect damages of any kind or nature (including lost profits or damages for loss of time or loss of use or loss of data) arising from or in any connection with the use or performance of a Product or a failure of a Product, even if Sharp is aware of or has been advised of the possibility of such damages; (b) the remedies described in this limited warranty constitute complete fulfillment of all obligations and responsibilities of Sharp to the purchaser with respect to the Product and shall constitute full satisfaction of all claims, whether based on contract, negligence, strict liability or otherwise. Some provinces may not allow the exclusion or limitation of certain damages, or limits on the duration or voiding of implied warranties or conditions; in such provinces, the exclusions and limits herein may not apply. This limited warranty is, except for consumer purchasers domiciled in Quebec, governed by the laws of the Province in Canada in which the purchaser has purchased the Product. For consumer purchasers domiciled in Quebec this limited warranty is governed by the laws of Quebec.

WARRANTY PERIODS (calculated from the date of original purchase): Parts & Labour (exceptions noted)

Audio Product	1 year
Blu-Ray Product	1 year
Projector	1 year (lamp 90 days)
LCD TV	1 year
Microwave Oven	1 year (magnetron component-4 additional years)
Air Purifier	1 year
Portable Air Conditioner	1 year
Plasmacluster Ion Generator	1 year
3D Glasses	1 year
Wireless LAN Adapter	1 year

To obtain the name and address of the nearest Authorized Sharp Service Centre or Dealer, or for more information on this Limited Warranty, Sharp Extended Warranty Offers, Sharp Canada Products or Accessory Sales, please contact Sharp:

- By writing to Sharp Electronics Of Canada Ltd. at 335 Britannia Road East
Mississauga, Ontario L4Z 1W9
- Calling: at 905-568-7140
- Visiting our Web site: www.sharp.ca



THIS LIMITED WARRANTY IS VALID ONLY IN CANADA

Revision 12/17/10

Dimensional Drawings

LC-70LE845U

Unit: inch (mm)
 Unité: pouce (mm)
 Unidad: pulgada (mm)

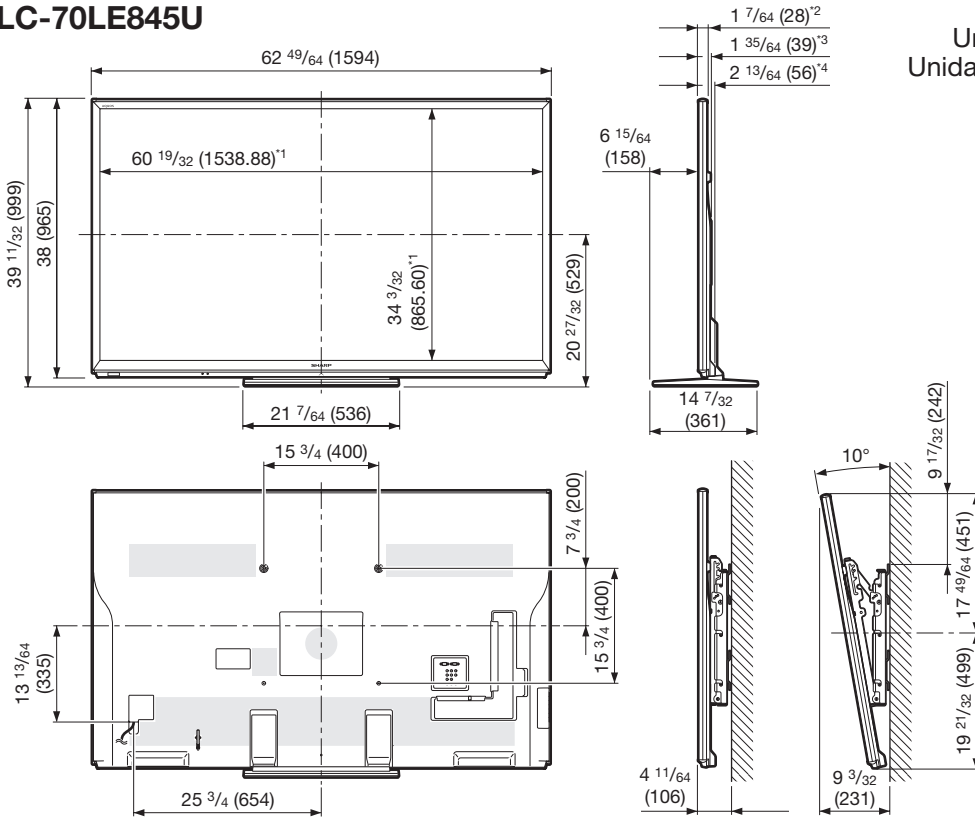

AN-52AG4

LC-60LE845U

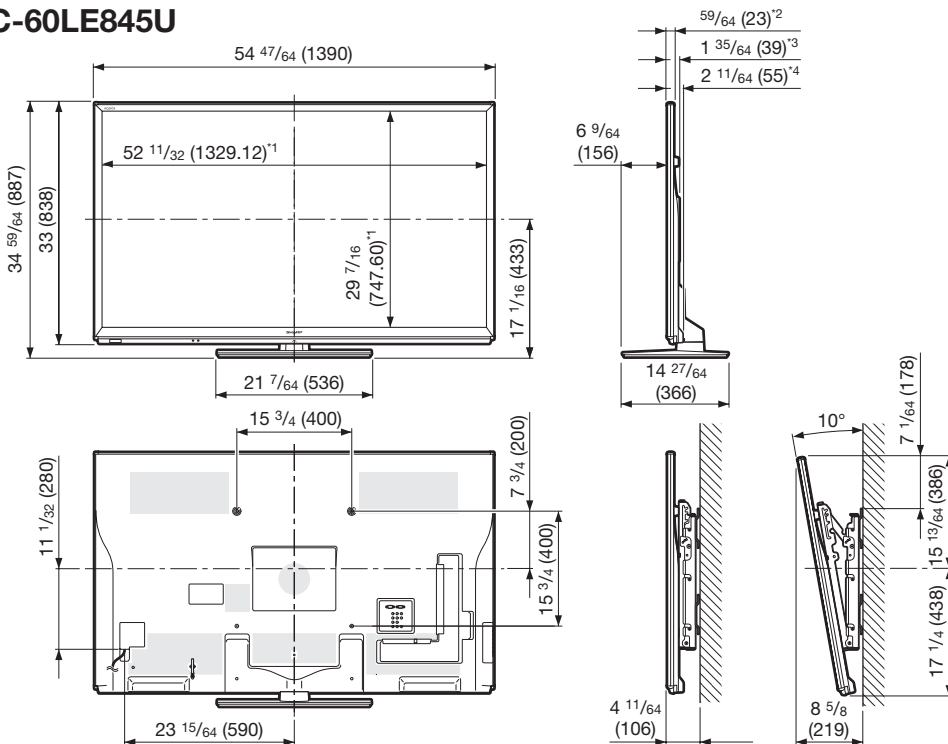

AN-52AG4

¹ Active area/Área activa/Zona active

² Thinnest part/Parte más delgada/Partie la plus mince

³ Excluding projecting parts/Excluyendo partes salientes/Sauf les parties saillantes

⁴ Including projecting parts/Incluyendo partes salientes/Parties saillantes incluses

SHARP[®]

SHARP ELECTRONICS CORPORATION

Sharp Plaza, Mahwah, New Jersey 07495-1163

SHARP CORPORATION

Printed in Mexico
Imprimé au Mexique
Impreso en México
TINS-F442WJZZ
12P03-MX-NM