

SHARP®

AQUOS

LC-19DV28UT LC-22DV28UT

COMBINATION LIQUID CRYSTAL TELEVISION
AND DVD/CD PLAYER

COMBINÉ TÉLÉVISEUR ACL ET LECTEUR DVD/CD

COMBINACION TELEVISOR CON PANTALLA DE
CRISTAL LÍQUIDO CON DVD/DISCOS COMPACTOS

OPERATION MANUAL

MODE D'EMPLOI

MANUAL DE OPERACIÓN



ENGLISH

FRANÇAIS

ESPAÑOL



IMPORTANT : Please read this operation manual before starting operating the equipment.

IMPORTANT : Veuillez lire ce mode d'emploi avant de commencer à utiliser l'appareil.

IMPORTANTE : Lea este manual de operación antes de comenzar a operar el equipo.

LC-19DV28UT LC-22DV28UT

COMBINATION LIQUID CRYSTAL TELEVISION AND DVD/CD PLAYER

ENGLISH

OPERATION MANUAL

IMPORTANT:

- To aid reporting in case of loss or theft, please record the TV/DVD's model and serial numbers in the space provided. The numbers are located at the rear of the TV/DVD.

Model No.:

Serial No.:

Location of the required Marking

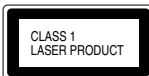

The rating sheet and the safety caution are on the rear of the unit.



CERTIFICATION: COMPLIES WITH FDA RADIATION PERFORMANCE STANDARDS, 21 CFR SUBCHAPTER J. COMPLIES WITH FDA PERFORMANCE STANDARDS FOR LASER PRODUCTS EXCEPT FOR DEVIATIONS PURSUANT TO LASER NOTICE NO. 50, DATED JUNE 24, 2007.

IMPORTANT INFORMATION

WARNING: TO REDUCE THE RISK OF FIRE OR ELECTRIC SHOCK, DO NOT EXPOSE THIS PRODUCT TO RAIN OR MOISTURE.

	<p>CAUTION</p> <p>RISK OF ELECTRIC SHOCK DO NOT OPEN</p>	
<p>CAUTION: TO REDUCE THE RISK OF ELECTRIC SHOCK, DO NOT REMOVE COVER (OR BACK). NO USER-SERVICEABLE PARTS INSIDE. REFER SERVICING TO QUALIFIED SERVICE PERSONNEL.</p>		



The lightning flash with arrow-head symbol, within an equilateral triangle, is intended to alert the user to the presence of uninsulated "dangerous voltage" within the product's enclosure that may be of sufficient magnitude to constitute a risk of electric shock to persons.



The exclamation point within a triangle is intended to alert the user to the presence of important operating and maintenance (servicing) instructions in the literature accompanying the product.

CAUTION: TO PREVENT ELECTRIC SHOCK, MATCH WIDE BLADE OF PLUG TO WIDE SLOT, FULLY INSERT.

IMPORTANT INFORMATION

WARNING: FCC Regulations state that any unauthorized changes or modifications to this equipment not expressly approved by the manufacturer could void the user's authority to operate this equipment.

CAUTION:

This product satisfies FCC regulations when shielded cables and connectors are used to connect the unit to other equipment. To prevent electromagnetic interference with electric appliances such as radios and televisions, use shielded cables and connectors for connections.

"Note to CATV system installer: This reminder is provided to call the CATV system installer's attention to Article 820-40 of the National Electrical Code that provides guidelines for proper grounding and, in particular, specifies that the cable ground shall be connected to the grounding system of the building, as close to the point of cable entry as practical."

This product utilizes tin-lead solder, and fluorescent lamp containing a small amount of mercury. Disposal of these materials may be regulated due to environmental considerations. For disposal or recycling information, please contact your local authorities, the Electronic Industries Alliance: www.eiae.org, the lamp recycling organization: www.lamprecycle.org or Sharp at 1-800-BE-SHARP (For U.S.A. Only)

DECLARATION OF CONFORMITY

SHARP COMBINATION LIQUID CRYSTAL TELEVISION AND DVD CD PLAYER, MODEL LC-19DV28UT/LC-22DV28UT.

This device complies with Part 15 of the FCC Rules. Operation is subject to the following two conditions:

(1) This device may not cause harmful interference, and (2) this device must accept any interference received, including interference that may cause undesired operation.

RESPONSIBLE PARTY:

SHARP ELECTRONICS CORPORATION
Sharp Plaza, Mahwah, New Jersey 07495-1163
TEL: 1-800-BE-SHARP

For Business Customers: URL <http://www.sharpusa.com>

INFORMATION:

This equipment has been tested and found to comply with the limits for a Class B digital device, pursuant to Part 15 of the FCC Rules. These limits are designed to provide reasonable protection against harmful interference in a residential installation. This equipment generates, uses and can radiate radio frequency energy and, if not installed and used in accordance with the instructions, may cause harmful interference to radio communications. However, there is no guarantee that interference will not occur in a particular installation. If this equipment does cause harmful interference to radio or television reception, which can be determined by turning the equipment off and on, the user is encouraged to try to correct the interference by one or more of the following measures:

- Reorient or relocate the receiving antenna.
- Increase the separation between the equipment and receiver.
- Connect the equipment into an outlet on a circuit different from that to which the receiver is connected.
- Consult the dealer or an experienced radio/TV technician for help.

License information

- * This product incorporates copy protection technology that is protected by U.S. and other intellectual property rights. The use of Rovi Corporation's copy protection technology in the product must be authorized by Rovi Corporation. Reverse engineering or disassembly is prohibited.
- * Manufactured under license from Dolby Laboratories. Dolby and the double-D symbol are trademarks of Dolby Laboratories.
- * DVD Logo is a trademark of DVD Format/Logo Licensing Corporation.
- * This product is protected by certain intellectual property rights of Microsoft. Use or distribution of such technology outside of this product is prohibited without a license from Microsoft.
- * HDMI, the HDMI Logo, and High-Definition Multimedia Interface are trademarks or registered trademarks of HDMI Licensing LLC in the United States and other countries.
- * Manufactured under license under U.S. Patent #: 5,451,942 & other U.S. and worldwide patents issued & pending. DTS and the Symbol are registered trademarks and DTS Digital Out and the DTS logos are trademarks of DTS, Inc. Product includes software. © DTS, Inc. All Rights Reserved.
- * Products that have earned the ENERGY STAR® are designed to protect the environment through superior energy efficiency.

DEAR SHARP CUSTOMER

Thank you for your purchase of the Sharp Combination Liquid Crystal Television and DVD/CD player. To ensure safety and many years of trouble-free operation of your product, please read the Important Safety Instructions carefully before using this product.

IMPORTANT SAFETY INSTRUCTIONS

Electricity is used to perform many useful functions, but it can also cause personal injuries and property damage if improperly handled. This product has been engineered and manufactured with the highest priority on safety. However, improper use can result in electric shock and/or fire. In order to prevent potential danger, please observe the following instructions when installing, operating and cleaning the product. To ensure your safety and prolong the service life of your Liquid Crystal Television, please read the following precautions carefully before using the product.

- 1) Read these instructions.
- 2) Keep these instructions.
- 3) Heed all warnings.
- 4) Follow all instructions.
- 5) Do not use this apparatus near water.
- 6) Clean only with dry cloth.
- 7) Do not block any ventilation openings. Install in accordance with the manufacturer's instructions.
- 8) Do not install near any heat sources such as radiators, heat registers, stoves, or other apparatus (including amplifiers) that produce heat.
- 9) Do not defeat the safety purpose of the polarized or grounding-type plug. A polarized plug has two blades with one wider than the other. A grounding type plug has two blades and a third grounding prong. The wide blade or the third prong are provided for your safety. If the provided plug does not fit into your outlet, consult an electrician for replacement of the obsolete outlet.
- 10) Protect the power cord from being walked on or pinched particularly at plugs, convenience receptacles, and the point where they exit from the apparatus.
- 11) Only use attachments/accessories specified by the manufacturer.
- 12) Use only with the cart, stand, tripod, bracket, or table specified by the manufacturer, or sold with the apparatus. When a cart is used, use caution when moving the cart/apparatus combination to avoid injury from tip-over.
- 13) Unplug this apparatus during lightning storms or when unused for long periods of time.
- 14) Refer all servicing to qualified service personnel. Servicing is required when the apparatus has been damaged in any way, such as power-supply cord or plug is damaged, liquid has been spilled or objects have fallen into the apparatus, the apparatus has been exposed to rain or moisture, does not operate normally, or has been dropped.



Additional Safety Information

- 15) Power Sources—This product should be operated only from the type of power source indicated on the marking label. If you are not sure of the type of power supply to your home, consult your product dealer or local power company. For products intended to operate from battery power, or other sources, refer to the operating instructions.
- 16) Overloading—Do not overload wall outlets, extension cords, or integral convenience receptacles as this can result in a risk of fire or electric shock.
- 17) Object and Liquid Entry—Never push objects of any kind into this product through openings as they may touch dangerous voltage points or short-out parts that could result in a fire or electric shock. Never spill liquid of any kind on the product.
- 18) Damage Requiring Service—Unplug this product from the wall outlet and refer servicing to qualified service personnel under the following conditions:
 - a) When the AC cord or plug is damaged,
 - b) If liquid has been spilled, or objects have fallen into the product,
 - c) If the product has been exposed to rain or water,
 - d) If the product does not operate normally by following the operating instructions.
Adjust only those controls that are covered by the operating instructions as an improper adjustment of other controls may result in damage and will often require extensive work by a qualified technician to restore the product to its normal operation,
 - e) If the product has been dropped or damaged in any way, and
 - f) When the product exhibits a distinct change in performance - this indicates a need for service.
- 19) Replacement Parts—When replacement parts are required, be sure the service technician has used replacement parts specified by the manufacturer or have the same characteristics as the original part. Unauthorized substitutions may result in fire, electric shock, or other hazards.
- 20) Safety Check—Upon completion of any service or repairs to this product, ask the service technician to perform safety checks to determine that the product is in proper operating condition.
- 21) Wall or ceiling mounting—When mounting the product on a wall or ceiling, be sure to install the product according to the method recommended by the manufacturer.

IMPORTANT SAFETY INSTRUCTIONS

- **Outdoor Antenna Grounding** — If an outside antenna is connected to the television equipment, be sure the antenna system is grounded so as to provide some protection against voltage surges and built-up static charges. Article 810 of the National Electrical Code, ANSI/NFPA 70, provides information with regard to proper grounding of the mast and supporting structure, grounding of the lead-in wire to an antenna discharge unit, size of grounding conductors, location of antenna-discharge unit, connection to grounding electrodes, and requirements for the grounding electrode.

EXAMPLE OF ANTENNA GROUNDING AS PER NATIONAL ELECTRICAL CODE, ANSI/NFPA 70

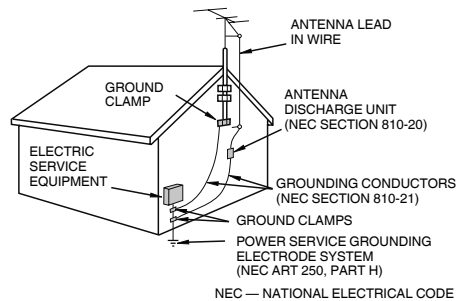

- **Water and Moisture** — Do not use this product near water - for example, near a bath tub, wash bowl, kitchen sink, or laundry tub; in a wet basement; or near a swimming pool; and the like.
- **Stand** — Do not place the product on an unstable cart, stand, tripod or table. Placing the product on an unstable base can cause the product to fall, resulting in serious personal injuries as well as damage to the product. Use only a cart, stand, tripod, bracket or table recommended by the manufacturer or sold with the product. When mounting the product on a wall, be sure to follow the manufacturer's instructions. Use only the mounting hardware recommended by the manufacturer.
- **Selecting the location** — Select a place with no direct sunlight and good ventilation.
- **Ventilation** — The vents and other openings in the cabinet are designed for ventilation. Do not cover or block these vents and openings since insufficient ventilation can cause overheating and/or shorten the life of the product. Do not place the product on a bed, sofa, rug or other similar surface, since they can block ventilation openings. This product is not designed for built-in installation; do not place the product in an enclosed place such as a bookcase or rack, unless proper ventilation is provided or the manufacturer's instructions are followed.
- **The Liquid Crystal panel used in this product is made of glass.** Therefore, it can break when the product is dropped or applied with impact. Be careful not to be injured by broken glass pieces in case the panel breaks.
- **Heat** — The product should be situated away from heat sources such as radiators, heat registers, stoves, or other products (including amplifiers) that produce heat.
- **The Liquid Crystal panel is a very high technology product with 1,049,088 pixels, giving you fine picture details.** Occasionally, a few non-active pixels may appear on the screen as a fixed point of blue, green or red. Please note that this does not affect the performance of your product.
- **Lightning** — For added protection for this television equipment during a lightning storm, or when it is left unattended and unused for long periods of time, unplug it from the wall outlet and disconnect the antenna. This will prevent damage to the equipment due to lightning and power-line surges.
- **Power Lines** — An outside antenna system should not be located in the vicinity of overhead power lines or other electric light or power circuits, or where it can fall into such power lines or circuits. When installing an outside antenna system, extreme care should be taken to keep from touching such power lines or circuits as contact with them might be fatal.
- **To prevent fire, never place any type of candle or flames on the top or near the TV set.**
- **To prevent fire or shock hazard, do not place the AC cord under the TV set or other heavy items.**
- **Do not display a still picture for a long time, as this could cause an afterimage to remain.**
- **To prevent fire or shock hazard, do not expose this product to dripping or splashing.** No objects filled with liquids, such as vases, should be placed on the product.
- **Do not insert foreign objects into the product.** Inserting objects in the air vents or other openings may result in fire or electric shock. Exercise special caution when using the product around children.
- **CONDENSATION** — Moisture will form in the operating section of the player if the player is brought from cool surroundings into a warm room or if the temperature of the room rises suddenly. When this happens, player's performance will be impaired. To prevent this, let the player stand in its new surroundings for about an hour before switching it on, or make sure that the room temperature rises gradually. Condensation may also form during the summer if the player is exposed to the breeze from an air conditioner. In such cases, change the location of the player.
- **DISC SLOT** — Keep your fingers well clear of the disc slot as it is closing. Failure to do so may cause serious personal injury.
- **LASER BEAM** — Do not look into the opening of the disc slot or ventilation opening of the product to see the source of the laser beam. Doing so may cause sight damage.
- **DISC** — Do not use a cracked, deformed, or repaired disc. These discs are easily broken and may cause serious personal injury and product malfunction.

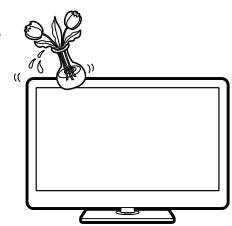

Precautions when transporting the TV

- When transporting the TV, never carry it by holding or otherwise putting pressure onto the display. Be sure to always carry the TV by two people holding it with two hands — one hand on each side of the TV.

Caring for the Cabinet

- Use a soft cloth (cotton, flannel, etc.) and gently wipe the surface of the cabinet.
 - Using a chemical cloth (wet/dry sheet type cloth, etc.) may deform the components of the main unit cabinet or cause cracking.
 - Wiping with a hard cloth or using strong force may scratch the surface of the cabinet.
 - If the cabinet is very dirty, wipe with a soft cloth (cotton, flannel, etc.) soaked in neutral detergent diluted with water and thoroughly wrung out, and then wipe with a soft dry cloth.
 - The cabinet is primarily made of plastic. Avoid using benzene, thinner, and other solvents, as these may deform the cabinet and cause the paint to peel off.
 - Do not apply insecticides or other volatile liquids.
- Also, do not allow the cabinet to remain in contact with rubber or vinyl products for a long period of time. Plasticizers inside the plastic may cause the cabinet to deform and cause the paint to peel off.

IMPORTANT SAFETY INSTRUCTIONS

Caring for the Liquid Crystal panel

- Turn off the main power and unplug the AC cord from the wall outlet before handling.
- Gently wipe the surface of the display panel with a soft cloth (cotton, flannel, etc.). To protect the display panel, do not use a dirty cloth, liquid cleaners, or a chemical cloth (wet/dry sheet type cloth, etc.). This may damage the surface of the display panel.
- Wiping with a hard cloth or using strong force may scratch the surface of the display panel.
- Use a soft damp cloth to gently wipe the display panel when it is really dirty. (It may scratch the surface of the display panel when wiped strongly.)
- If the display panel is dusty, use an anti-static brush, which is commercially available, to clean it.
- To avoid scratching the frame or screen, please use a soft, lint free cloth for cleaning. Approved cleaning cloths are available directly from Sharp in single (00Z-LCD-CLOTH) or triple (00Z-LCD-CLOTH-3) packs. Call 1-800-BE-SHARP for ordering, or VISIT www.sharpsusa.com/SharpDirect.

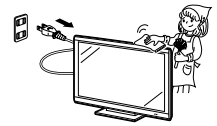

CHILD SAFETY

It Makes A Difference How and Where You Use Your Flat Panel Display

Congratulations on your purchase! As you enjoy your new product, please keep these safety tips in mind:



THE ISSUE

- The home theater entertainment experience is a growing trend and larger flat panel displays are popular purchases. However, flat panel displays are not always supported on the proper stands or installed according to the manufacturer's recommendations.
- Flat panel displays that are inappropriately situated on dressers, bookcases, shelves, desks, speakers, chests or carts may fall over and cause injury.

THIS MANUFACTURER CARES!

- The consumer electronics industry is committed to making home entertainment enjoyable and safe.

TUNE INTO SAFETY

- One size does NOT fit all. Follow the manufacturer's recommendations for the safe installation and use of your flat panel display.
- Carefully read and understand all enclosed instructions for proper use of this product.
- Don't allow children to climb on or play with furniture and television sets.
- Don't place flat panel displays on furniture that can easily be used as steps, such as a chest of drawers.
- Remember that children can become excited while watching a program, especially on a "larger than life" flat panel display. Care should be taken to place or install the display where it cannot be pushed, pulled over, or knocked down.
- Care should be taken to route all cords and cables connected to the flat panel display so that they cannot be pulled or grabbed by curious children.

WALL MOUNTING: IF YOU DECIDE TO WALL MOUNT YOUR FLAT PANEL DISPLAY, ALWAYS:

- Use a mount that has been recommended by the display manufacturer and/or listed by an independent laboratory (such as UL, CSA, ETL).
- Follow all instructions supplied by the display and wall mount manufacturers.
- If you have any doubts about your ability to safely install your flat panel display, contact your retailer about professional installation.
- Make sure that the wall where you are mounting the display is appropriate. Some wall mounts are not designed to be mounted to walls with steel studs or old cinder block construction. If you are unsure, contact a professional installer.
- A minimum of two people are required for installation. Flat panel displays can be heavy.







Note: CEA is the preeminent trade association promoting growth in the \$161 billion U.S. consumer electronics industry. More than 2,200 companies enjoy the benefits of CEA membership, including legislative advocacy, market research, technical training and education, industry promotion and the fostering of business and strategic relationships.

Disc

■ Discs which can be played back

In this unit, use only discs that meet the standard, such as those bearing the below logo marks on the disc label surface. If you use a non-standard disc, we cannot guarantee playback. Even if such a disc can be played back, we cannot guarantee the image or sound quality. The DVD logo is a registered trademark.

Media type	Logo mark
DVD-Video	
DVD-R/RW (Video format only)	
Audio CD*	
CD-R/CD-RW (CD-DA, MP3, WMA or JPEG format)	

- * This unit is designed to playback music Compact Discs (CD) that conform to the CD standard. CDs that contain (copy-restriction) signals to protect copyrights cannot be played back.
- Some CD-R/RWs and DVD-R/RW can not be played back depending on the recording conditions.
 - 8 cm discs can be played without an adapter.

Region management information

This unit is designed and manufactured to support the region management information that is recorded on a DVD disc. If the region number written on the DVD disc does not correspond to the region number of this unit, this unit cannot play that disc.

- The region number of this unit is "1".
- The unit will play DVD-Video discs marked with labels containing "1" or "ALL".

Example:



Operating DVD-Video

- Some operations of DVD-Video may be prohibited by the manufacturer, or some operation methods or functions of the DVD-Video may be different from the description in this manual.
- If you attempt an operation that is prohibited by either the disc or the unit, "This operation can't be performed" will appear on the TV screen. For operations prohibited by the disc, see the information that came with the disc.
- When the menu screen or the operation guide appears during disc playback, follow the displayed information.

■ Discs which cannot be played back

The discs listed below cannot be played back in general. Even if one of these can be played back, it may not be played back correctly. If a disc is played back by mistake, extensively loud sounds may blow the speakers or may damage the hearing of those in hearing range. Do not playback the discs listed below.

CDG, Photo-CD, CD-ROM, CD-TEXT, CD-EXTRA, SACD, PD, DVD-ROM, SVCD, CVD, VCD, DVD-RAM, DVD+R/RW, DVD audio, HD DVD, Blu-ray, etc.

The following DVD-Video discs may not be played back on this unit:

- DVD-Video that do not have the region number "1" or "ALL".
- Prohibited or business-use DVD-Video.

CD-R/CD-RWs cannot be played back for the following reasons.

- Compatibility of the disc and this unit.
- Compatibility of the disc and the recorder used.
- Unfinalised discs.

Never use the following discs or accessories. It may cause serious damage to the TV/DVD.

- Irregular shaped discs such as card shaped, heart shaped
- The ring protector or other disc accessories
- The 8 cm disc adapter
- Stickered or papered discs
- Discs with scotch tape, glue or other remains of labels

■ Title/Chapter/Track

A DVD-Video has large partitions called "Titles", and smaller partitions within them called "Chapters".

A audio CD has other partitions called "Tracks".

A number is allotted to each partition and these numbers are called "title numbers", "chapter numbers" or "track numbers".

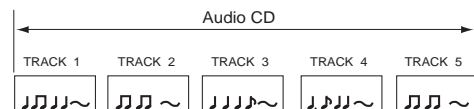

Disc

■ Title/Chapter/Track PC-created disc

- You may not be able to play discs recorded using a personal computer or recorder for disc compatibilities, scratches or marks on the disc, dirty lenses of the unit or condensation and so on.
- Discs recorded using a personal computer may not be playable in this unit due to the setting of the application software used to create the disc. In these particular instances, check with the software publisher for more detailed information.

■ Playable files

- ISO 9660 Level 1 or 2 compliant.
Romeo and Joliet file systems are both compatible with this player.
- DRM (Digital Rights Management) protected files will not play in this player.
For detailed information, please see the instruction manuals or help files that came with your PC and/or software.
- File structure (may differ): Up to 299 folders on a disc; up to 648 files within each folder
- Folder and file names can be displayed as long as they are typed in alphabets and numbers. If folder and file names are other than alphabets and numbers, they may be replaced and displayed like as “_”. Garbled characters may also be displayed in this case.

■ Playing image files

JPEG files recorded in DVD-R/-RW and CD-R/-RW can be played.

■ JPEG file compatibility

- Image files should be saved in JPEG format.
- Files recorded in Fuji Colour CD, Kodak Picture CD or CD-R/-RW can be played.
- Compatible formats: Baseline JPEG and EXIF 2.2* still image files up to a resolution of 3072 x 2048.
*File format used by digital still cameras.
- Files with extensions .jpg or .JPG can be played.
- Progressive JPEG formatted files do not work.
- It may take some more time to start to play larger files than usual.
- JPEG files with different aspect ratio may be displayed with black bands (either vertical or horizontal).

■ Playing Audio files

WMA and MP3 files recorded in DVD-R/-RW, CD-R/-RW can be played.

■ Windows Media Audio (WMA) compatibility

- WMA is an acronym for Windows Media Audio and refers to an audio compression technology developed by Microsoft Corporation.
- You can encode your files by using Windows Media Player Ver.7, 7.1, Windows Media Player for Windows XP or Windows Media Player 9 Series.
- When encoding your files, use only applications approved by Microsoft Corporation. If you use non-approved application, it may not work properly.
- This unit is compatible with audio files recorded with the following sampling frequency: 32 kHz, 44.1 kHz and 48 kHz.
- It is not compatible with loss-less encoding.
- Files with extensions .wma or .WMA can be played.

■ Playing MP3 (MPEG-1 Audio Layer-3) files

- This unit is compatible with audio files recorded with the following sampling frequency: 32 kHz, 44.1 kHz and 48 kHz.
- Files with extensions .mp3 or .MP3 can be played.
- For the best quality of sound, 128 kbps or higher bit rate is recommended.

■ Copy Control CD (CCCD)

This product is designed to conform to CD-DA (Compact Disc Digital Audio). Any other discs than CD-DA are not guaranteed with their operation and performance in this product.

■ Handling discs

Removing the Disc from its case

Be sure to hold the edge of disc. Do not touch the surface of the disc.

Pick up the disc gently from the case.

- Do not scratch the disc.
- Do not get dirt on the surface of the disc.
- Do not stick a label or adhesive tape on the disc.
- Do not drop or bend the disc.



Storing discs

- Store the disc in the case to avoid any risk of scratches, dirt or damage.
- Do not leave the disc exposed to direct sunlight or in hot or humid places.

Cleaning discs

Wipe the disc with a clean, dry cloth from the center outward toward the edges.

- Do not wipe the disc in a circular motion around the center.
- Do not use liquid or aerosol cleaners.

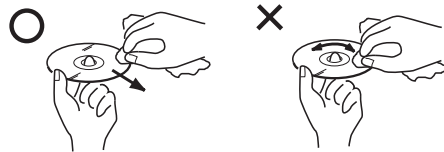

Note on copyright

- Unauthorized recording of copyrighted television programs, films, video cassettes and other materials may infringe the rights of copyright owners and be contrary to copyright laws.

Supplied accessories

Make sure the following accessories are provided with the product.



Remote control unit
(x1)
Page 10



"AA" size battery (x2)
Page 10



AC cord (x1)
Page 9



Stand unit (x1) and
Screws (x3)
Page 8



Operation manual (x1)

NOTE

- Always use the AC cord supplied with the TV/DVD.

QUICK REFERENCE

Attaching the stand

- Before attaching (or detaching) the stand, unplug the AC cord from the AC input terminal.
- Before performing work spread cushioning over the base area to lay the TV/DVD on. This will prevent it from being damaged.

CAUTION

- **Attach the stand in the correct direction.**
- **Be sure to follow the instructions. Incorrect installation of the stand may result in the TV/DVD falling over.**

- 1 Confirm the 3 screws supplied with the TV/DVD.

Screws (x3)

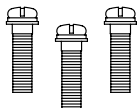

- 2 Remove the covering sheet of the stand.

- ① Insert the stand to the bottom of the TV/DVD.
- ② Insert and tighten the 3 screws into the 3 holes on the bottom of the stand.

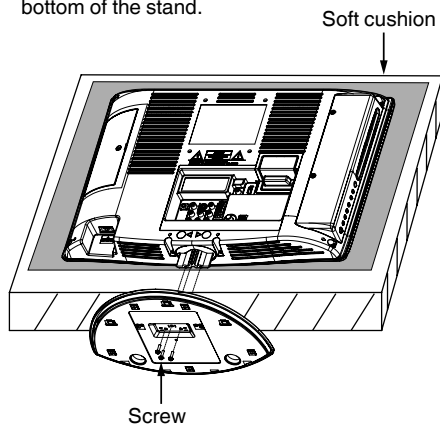

- 3 For protection, sheets are covering the product. Please remove these sheets before use.

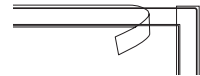

NOTE

- To detach the stand, perform the step in reverse order.

QUICK REFERENCE

QUICK INSTALLATION TIPS

- 1 Attach your antenna to the back of the TV/DVD.
(See page 14.)
- 2 Connect the AC plug for the TV/DVD into the wall outlet.

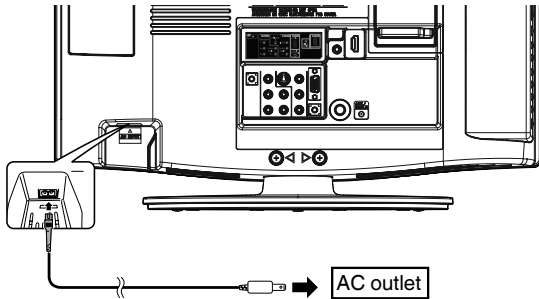

- Place the TV/DVD close to the AC outlet, and keep the power plug within reach.

NOTE

- **TO PREVENT RISK OF ELECTRIC SHOCK, DO NOT TOUCH UN-INSULATED PARTS OF ANY CABLES WITH THE AC CORD CONNECTED.**

- 3 How to turn on the TV/DVD for the first time.

A) Press **POWER** on TV/DVD.

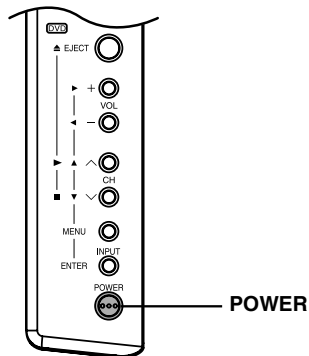

B) **POWER** indicator on the front of the TV/DVD lights GREEN.

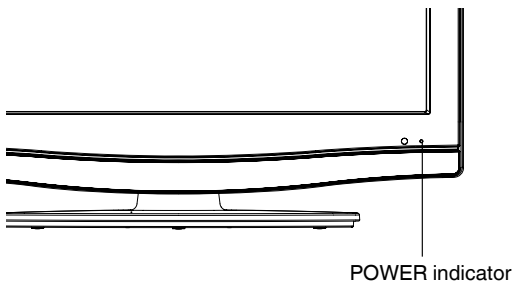

NOTE

- Speaker cannot be detached from the TV/DVD.
- TV/DVD angle cannot be adjusted.

QUICK REFERENCE

If the remote control fails to operate TV/DVD functions, replace the batteries in the remote control unit.

1 Open the battery cover.

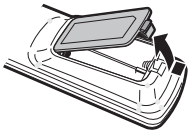

2 Insert two "AA" size batteries (supplied with the product).

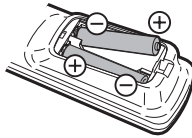

3 Close the battery cover.

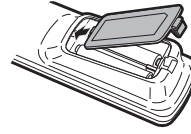

- Place the batteries with their terminals corresponding to the (+) and (-) indications in the battery compartment.

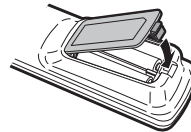

NOTE

Improper use of batteries can result in chemical leakage or explosion. Be sure to follow the instructions below.

- Do not mix batteries of different types. Different types of batteries have different characteristics.
- Do not mix old and new batteries. Mixing old and new batteries can shorten the life of new batteries or cause chemical leakage in old batteries.
- Remove batteries as soon as they are worn out. Chemicals that leak from batteries that come in contact with skin can cause a rash. If you find any chemical leakage, wipe thoroughly with a cloth.
- The batteries supplied with this product may have a shorter life expectancy due to storage conditions.
- If you will not be using the remote control unit for an extended period of time, remove batteries from it.

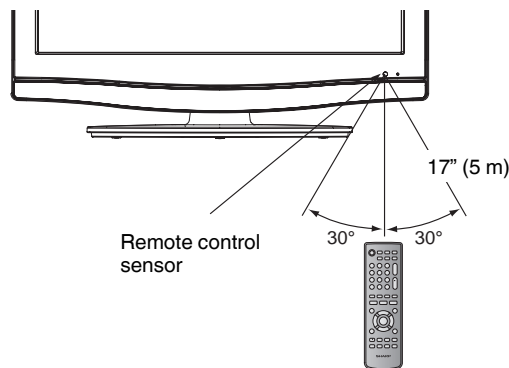

IMPORTANT:

The **POWER** indicator on the television should light **GREEN** indicating you have power to the TV/DVD.

If the **POWER** indicator on the television still does not light up, press **POWER** on the remote control to turn the power on.

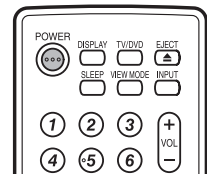

IMPORTANT:

IF THE UNIT DOES NOT POWER ON - UNPLUG THE TELEVISION FROM THE OUTLET AND REPEAT THE INSTALLATION STEPS.

IF YOU STILL ENCOUNTER NO POWER, PLEASE CONTACT US AT 1-800-BE-SHARP.

Contents

IMPORTANT INFORMATION	1	Watching the DVD	29
License information	2	Preparation	29
DEAR SHARP CUSTOMER	3	Turning on the power	29
IMPORTANT SAFETY INSTRUCTIONS	3	Select the DVD mode	29
Disc	6	Turning off the power	29
Supplied accessories	8	Playback procedure.....	29
QUICK REFERENCE	8	Status display of DVD disc.....	29
Attaching the stand	8	Special playback	30
Contents	11	Zooming	30
Part names	12	Locating desired scene.....	30
TV/DVD (Front).....	12	A-B Repeat playback.....	30
TV/DVD (Left)	12	Marking desired scenes.....	31
TV/DVD (Rear)	12	Changing angles.....	31
Remote control unit.....	13	Changing soundtrack language	31
Preparation	14	Subtitles.....	31
Using the remote control unit	14	Using HOME MENU	32
Cautions regarding remote control unit.....	14	Play mode.....	32
Antennas	14	Audio Settings menu.....	33
Using external equipment	15	Video Adjust menu	34
Experiencing HD images	15	Function setup	34
Types of Connection.....	15	Customizing The Function Settings	34
Displaying an External Equipment Image	15	Parental Control.....	36
Connecting to External Equipment	16	Appendix	37
Connecting a Blu-ray Disc/DVD Player or HD		Language Code List	37
Cable/Satellite Set-top Box.....	16	Country/Area Code List	37
Connecting a VCR, Game Console, Camcorder or		Troubleshooting.....	38
Cable/Satellite Set-top Box.....	17	Troubleshooting-Error Message	38
Connecting an Audio Amplifier	18	Troubleshooting-PC mode.....	38
Connecting a PC.....	18	Troubleshooting-DVD	39
Displaying an image from a PC.....	19	Specifications	40
PC compatibility chart.....	19	Calling for Service	41
Watching TV	20	LIMITED WARRANTY	41
Preparation	20		
Turning on the power	20		
Auto Setup.....	20		
Select the TV mode	20		
Turning off the power	20		
Changing channels.....	20		
Auto Ch Memory.....	21		
Skipping stored channel	21		
Clear All.....	21		
Display the channel information.....	21		
Setting MTS/SAP stereo mode	21		
Selecting the digital audio language	22		
View mode for 4:3 programs.....	22		
View mode for HD programs.....	22		
Labeling channels.....	22		
Closed captions and digital closed captions	23		
Caption setup	24		
Password setting for parental control.....	24		
How to enter the Lock menu	24		
To clear the all V-Chip settings	24		
Parental control (V-CHIP)	25		
TV Parental Guidelines (TV Guidelines)	25		
Voluntary movie rating system (MPAA)	25		
Canadian rating systems	26		
Canadian English ratings.....	26		
Canadian French ratings	26		
How to temporarily release the V-Chip block	26		
Other convenience functions	27		
Menu operation buttons	27		
Quick guide for MENU operation	27		

Dimensional drawings

- The dimensional drawings for the TV/DVD set are shown on the inside back cover.

Part names

TV/DVD (Front)

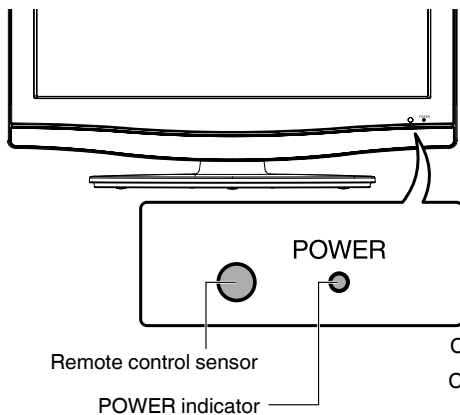

TV/DVD (Left)

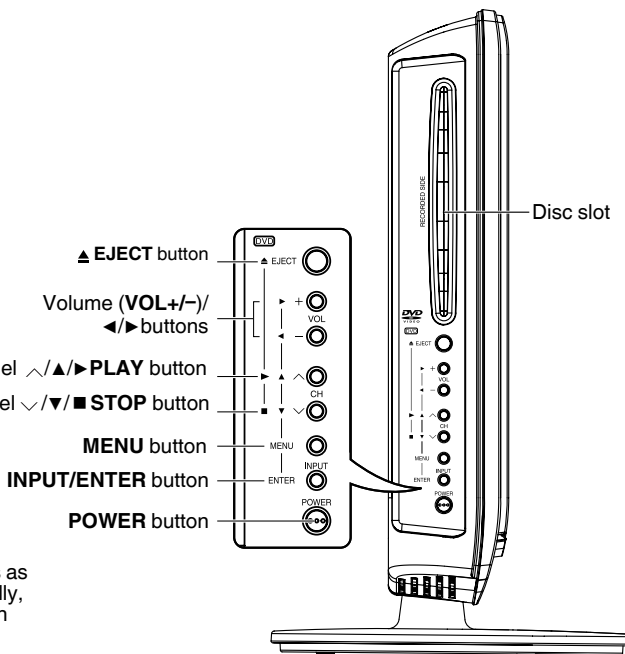

NOTE

- The buttons on the main unit have the same functions as the same buttons on the remote control. Fundamentally, this operation manual provides a description based on operation using the remote control.

TV/DVD (Rear)

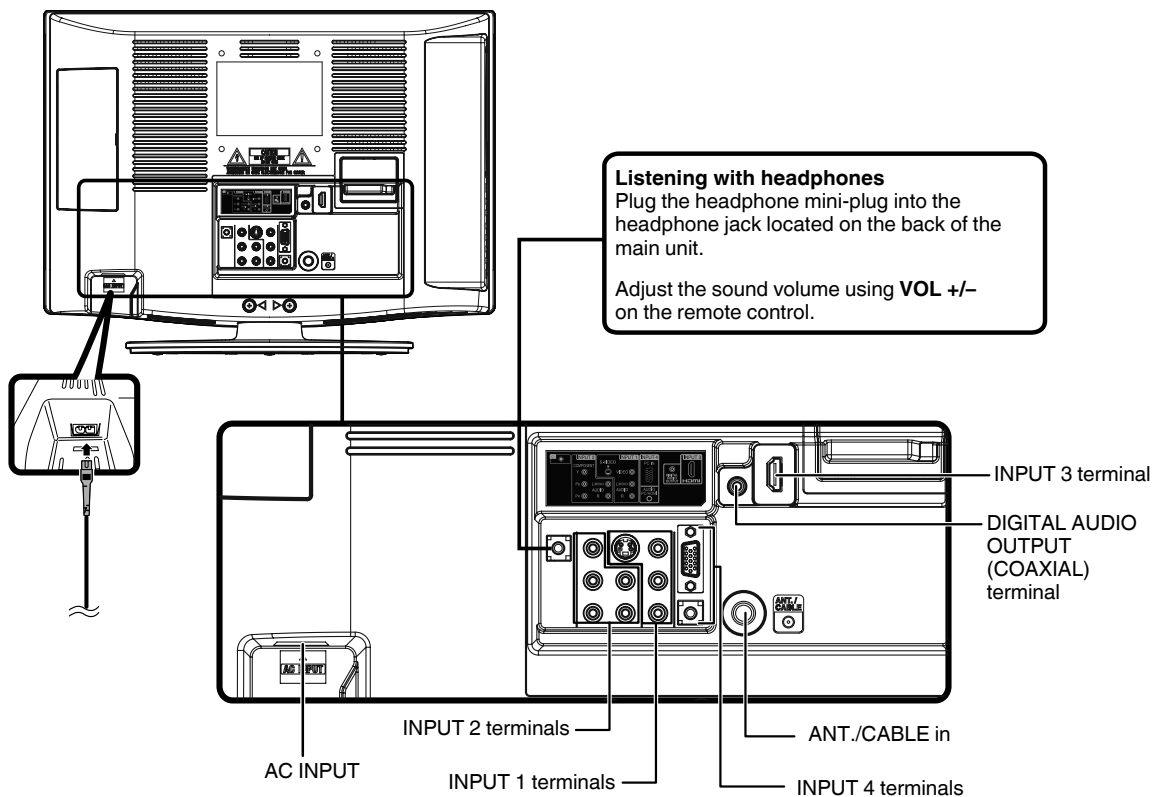

NOTE

- The illustrations in this operation manual are for explanation purposes and may vary slightly from the actual operations.
- The examples used throughout this manual are based on the LC-19DV28UT model.

Part names

Remote control unit

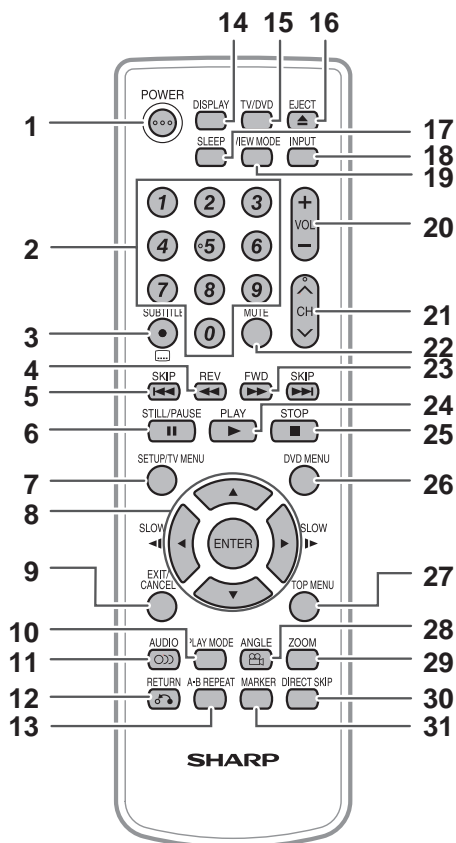

NOTE

- When using the remote control unit, point it at the TV/DVD. (See page 10.)

There is a protective film covering the face of the remote control. Please remove this film before use.

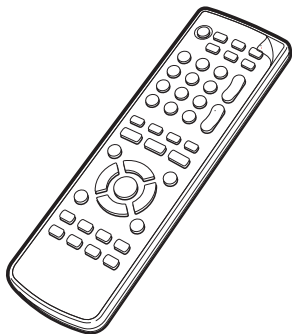

- 1 POWER:** Switch the power on or enters standby mode. (See page 20.)
- 2 0-9:** Set the channel. (See page 20.)
- 3 • (DOT) / SUBTITLE:** To select 4-digit channel number. (See page 20.) / Set subtitle. (See page 31.)

- 4 REV :** Review playback. (See page 30.)
- 5 SKIP ◀/▶:** Skip chapter to reverse or forward direction. (See page 30.)
- 6 STILL/PAUSE:** Still picture of DVD / Pause CD sound. (See page 30.)
- 7 SETUP/TV MENU:** TV mode - Display menu of TV / DVD mode - Call up initial setup mode. (See pages 27, 34.)
- 8 ▲/▼/◀/▶/ENTER:** Select a desired item on the screen.
- SLOW ◀/▶:** Reverse/Forward -slow motion. (See page 30.)
- 9 EXIT/CANCEL:** Turn off the menu screen / Reset information in the menu.
- 10 PLAY MODE:** Select playback mode. (See page 32.)
- 11 AUDIO:** Switch the sound of TV / Change sound track language. (See pages 21, 31.)
- 12 RETURN:** Turn off the DVD setup menu screen.
- 13 A-B REPEAT:** Repeat playback between A and B. (See page 30.)
- 14 DISPLAY:** Display the current channel (or input source) information on the screen. (See pages 21, 29.)
- 15 TV/DVD:** Switch between TV/AV and DVD. (See pages 20, 29.)
- 16 EJECT:** Eject the disc. (See page 29.)
- 17 SLEEP:** Allows you to set a time when the TV/DVD automatically switches to standby. Each time you press this button, the remaining time setting switches by 10 minutes up to 2 hours. This display will disappear after a few seconds, and the sleep timer automatically starts counting down.
 - If you want to adjust the sleep timer again, you can press this button repeatedly then change the time setting.
 - Select "Off" by pressing **SLEEP** repeatedly to cancel the sleep timer.
 - The TV/DVD will enter the standby mode when the remaining time reaches zero.
- 18 INPUT:** Select input source. (See page 15.)
- 19 VIEW MODE:** Select the screen size. (See page 22.)
- 20 VOL +/-:** Set the volume.
 - To increase the volume, press **VOL+**.
 - To decrease the volume, press **VOL-**.
- 21 CH ^/∨ :** Select the channel. (See page 20.)
- 22 MUTE:** Mute the sound. "Mute" will be displayed on the screen, and the sound is silenced. The muting feature can be released by pressing this button again or one of **VOL +/-**.
 - Sound via the COAXIAL DIGITAL AUDIO OUTPUT terminal is not muted.
- 23 FWD:** Fast forward playback. (See page 30.)
- 24 PLAY:** Playback. (See page 29.)
- 25 STOP:** Stop. (See page 29.)
- 26 DVD MENU:** Display DVD menu.
 - Press ▲/▼/◀/▶ to select desired title.
- 27 TOP MENU:** Display title menu.
 - Press ▲/▼/◀/▶ to select desired title.
- 28 ANGLE:** Change the view angle. (See page 31.)
- 29 ZOOM:** Zoom. (See page 30.)
- 30 DIRECT SKIP:** Locating desired scene. (See page 30.)
- 31 MARKER:** Index. (See page 31.)

Preparation

Using the remote control unit

Use the remote control unit by pointing it towards the remote control sensor on the TV/DVD. Objects between the remote control unit and the remote control sensor may prevent proper operation.

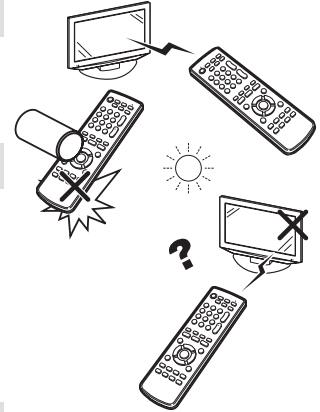

Cautions regarding remote control unit

- Do not expose the remote control unit to shock. In addition, do not expose the remote control unit to liquids, and do not place in an area with high humidity.
- Do not install or place the remote control unit under direct sunlight. The heat may cause deformation of the remote control unit.
- The remote control unit may not work properly if the remote control sensor on the TV/DVD is under direct sunlight or strong lighting. In such cases, change the angle of the lighting or the TV/DVD, or operate the remote control unit closer to the remote control sensor.

Antennas

To enjoy a clearer picture, use an outdoor antenna. The following is a brief explanation of the types of connections that are used for a coaxial cable. If your outdoor antenna uses a 75-ohm coaxial cable with an F-type connector, plug it into the antenna terminal at the rear of the TV set.

1. A 75-ohm system is generally a round cable with F-type connector that can easily be attached to a terminal without tools (Commercially available).

F-type connector

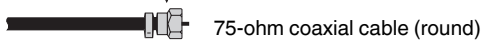

75-ohm coaxial cable (round)

2. A 300-ohm system is a flat "twin-lead" cable that can be attached to a 75-ohm terminal through a 300/75-ohm adapter (Commercially available).

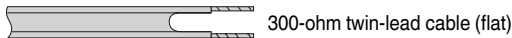

300-ohm twin-lead cable (flat)

NOTICE F-type connector should be fingertightened only.

When connecting the RF cable to the TV set, do not tighten F-type connector with tools.

If tools are used, it may cause damage to your TV set. (The breaking of internal circuit, etc.)



F-type connector

75-ohm coaxial cable

Connecting Antenna Cable

- ① Cable without a CATV converter

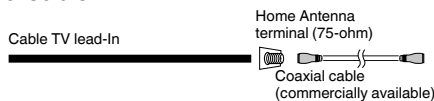

- ② VHF/UHF antenna

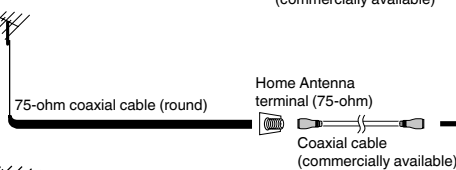

- ③ Combination VHF/UHF antenna

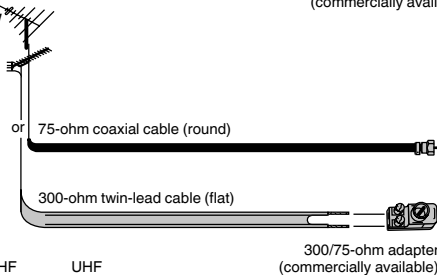

- ④ Separate VHF/UHF antenna

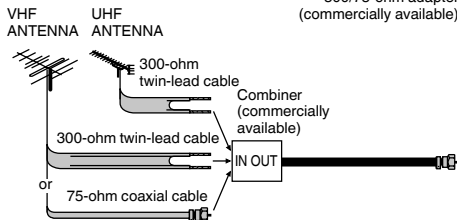

- Connect the antenna cable to the TV using one of the methods in the illustration as shown (①, ②, ③ or ④).

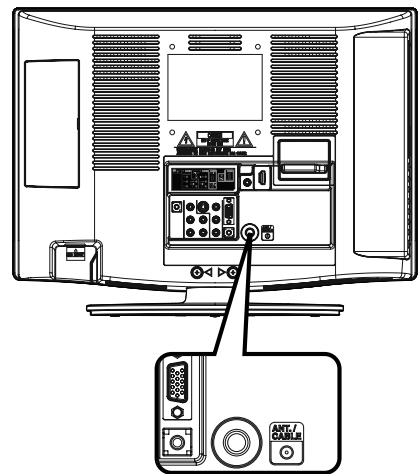

To TV antenna terminal

Using external equipment

Experiencing HD images

An HDTV without an HD source is just an ordinary TV/DVD.

To enjoy HD images on the TV/DVD, you should get HD programming from the following:

- Over-the-air broadcasting via HD quality antenna
- HD cable/satellite subscription
- HD compatible external equipment

NOTE

- For information on updating to HD programming, ask your cable/satellite service provider.

Types of Connection

Image quality differs depending on the terminal used. To enjoy clearer images, check the output terminals of your external equipment and use its appropriate terminals for higher quality images.

- The illustrations of the terminals are for explanation purposes and may vary slightly from the actual products.

Image Quality	Terminal on external equipment	Cable	Terminal on the TV	
		HDMI-certified cable		⇒ Page 16
	 AUDIO	DVI-HDMI conversion cable Ø 3.5 mm stereo minijack cable		⇒ Page 16
	 AUDIO	Component video cable Audio cable		⇒ Page 17
	 AUDIO	S-VIDEO cable Audio cable		⇒ Page 17
	 AUDIO	AV cable		⇒ Page 17

Displaying an External Equipment Image

To view external source images, select the input source by pressing **INPUT** on the remote control unit or on the TV/DVD.

NOTE

- For information on updating to HD programming, ask your cable/satellite service provider.

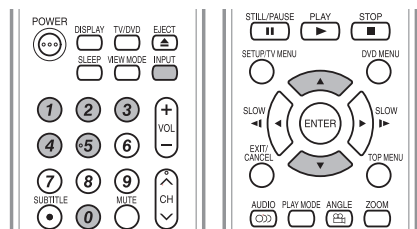

- 1 Press **INPUT**.
 - A list of selectable sources appears.
- 2 Press **0-5** to select the input source.
 - Each time **INPUT** is pressed, the input source toggles.

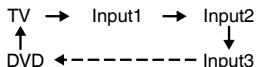

- You can also select the input source by pressing **▲/▼**.
- An image from the selected source automatically displays.

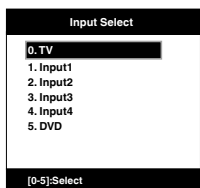
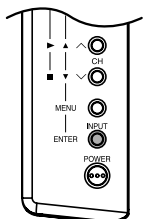

Connecting to External Equipment

You can connect many types of external equipment to your TV/DVD. To view external source images, select the input source from **INPUT** on the remote control unit or on the TV/DVD. (See page 15.) For connecting the TV/DVD to external equipment, use commercially available cables.

CAUTION

- To protect equipment, always turn off the TV/DVD before connecting any external equipment.
- Please read the relevant operation manual (Blu-ray disc player, etc.) carefully before making connections.

Connecting a Blu-ray Disc/DVD Player or HD Cable/Satellite Set-top Box

■ When using HDMI cable (INPUT 3):

The HDMI (High Definition Multimedia Interface) terminal is an audio-video interface that enables a connection for audio and video signals using a single cable. The HDMI terminal supports high-resolution video input.

- Blu-ray disc player
 - DVD player
 - HD cable/satellite set-top box
- Rear of the TV

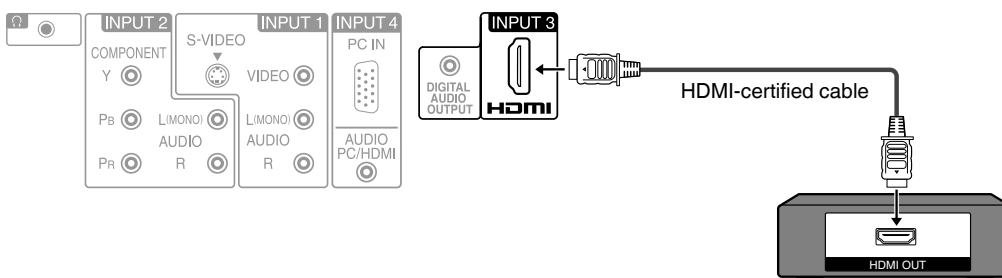

NOTE

- Supported Audio format: Linear PCM (sampling rate 32/44.1/48kHz) and Dolby Digital.
- Digital Audio output is not available when using an HDMI input.

■ When using DVI-HDMI conversion cable (INPUT 3):

- Blu-ray disc player
- DVD player
- HD cable/satellite set-top box

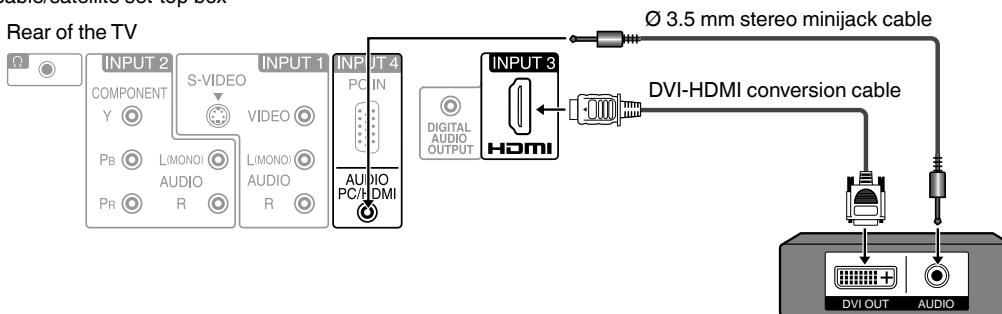

NOTE

- When using a DVI-HDMI conversion cable, you should make an analog audio connection. In this case, in addition to connecting a DVI-HDMI conversion cable to the INPUT 3 (HDMI) terminal, connect an audio cable to the AUDIO PC/HDMI terminal and set "HDMI Audio" to "DVI". (See page 28.)

Connecting to External Equipment

■ When using Component cable (INPUT 2):

- Blu-ray disc player
- DVD player
- HD cable/satellite set-top box

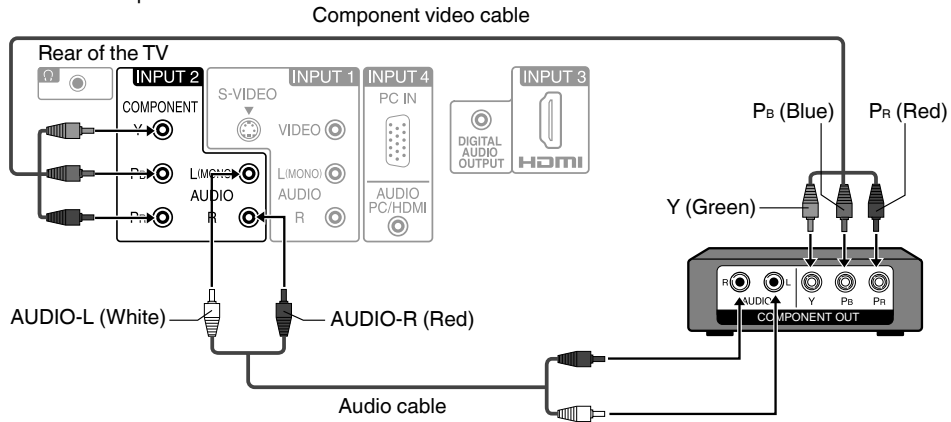

NOTE

- See page 16 for connecting a Blu-ray disc player, DVD player or an HD cable/satellite set-top box to the HDMI terminal.

Connecting a VCR, Game Console, Camcorder or Cable/Satellite Set-top Box

■ When using S-VIDEO cable (INPUT 1):

- Game Console
- Camcorder
- VCR

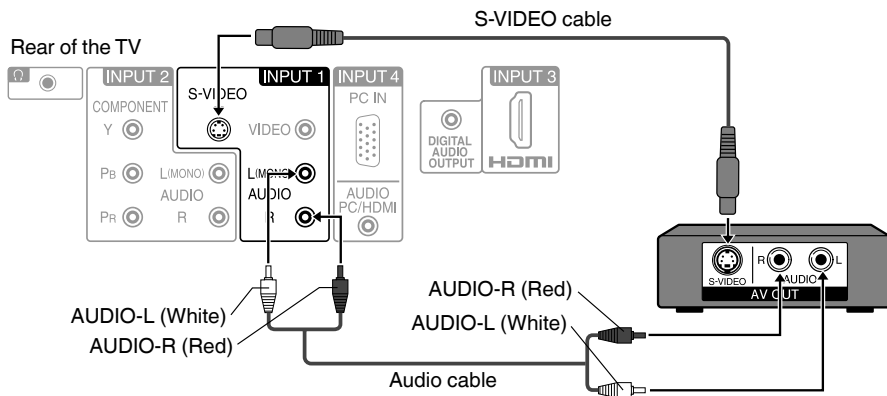

■ When using Composite cable (INPUT 1):

- Game console
- VCR
- Camcorder
- Cable/Satellite set-top box

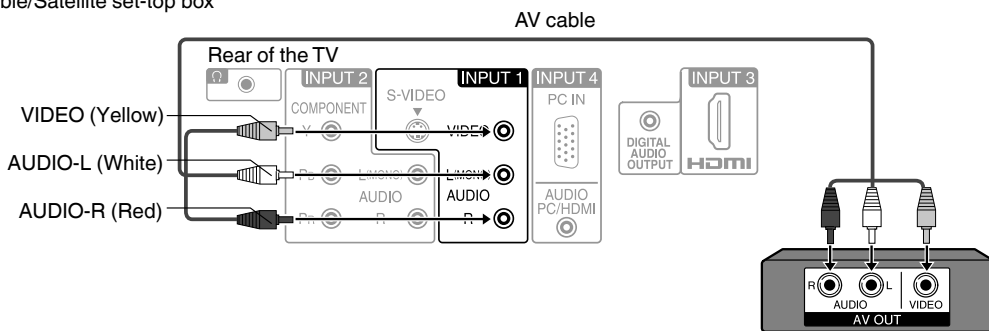

NOTE

- The S-VIDEO terminals take priority over the Video terminals.

Connecting to External Equipment

Connecting an Audio Amplifier

■ When using coaxial cable:

It is possible to output audio through the DIGITAL AUDIO OUTPUT terminal.

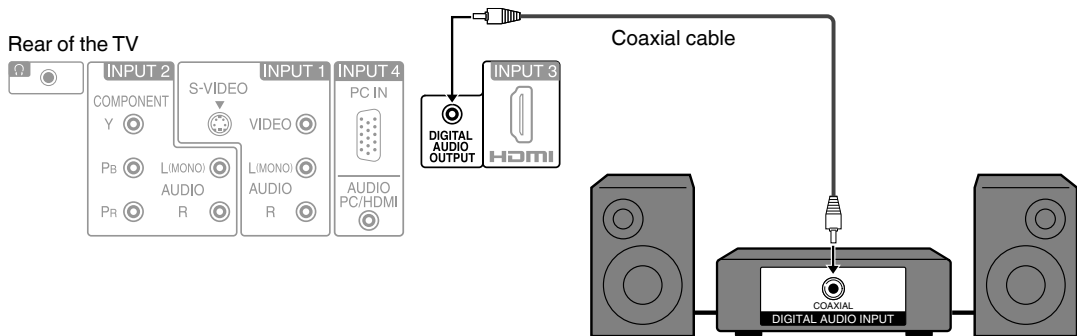

Connecting a PC

■ When using HDMI cable (INPUT 3):

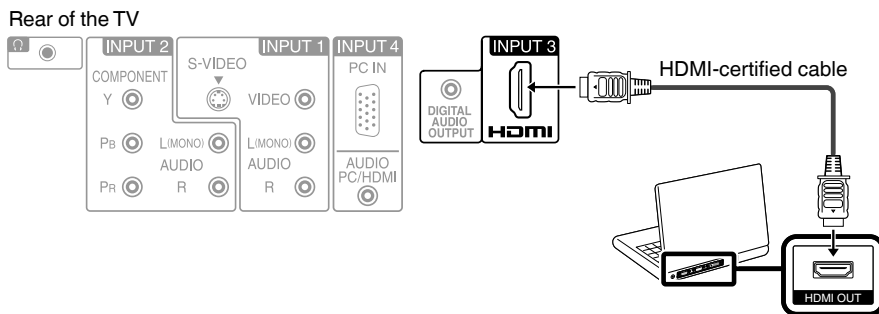

NOTE

- Depending on the board, only video signals may be output. In this case, in addition to connecting an HDMI-certified cable to the INPUT 3 (HDMI) terminal.
- The HDMI terminals only support digital signal.

■ When using DVI-HDMI conversion cable (INPUT 3):

Rear of the TV

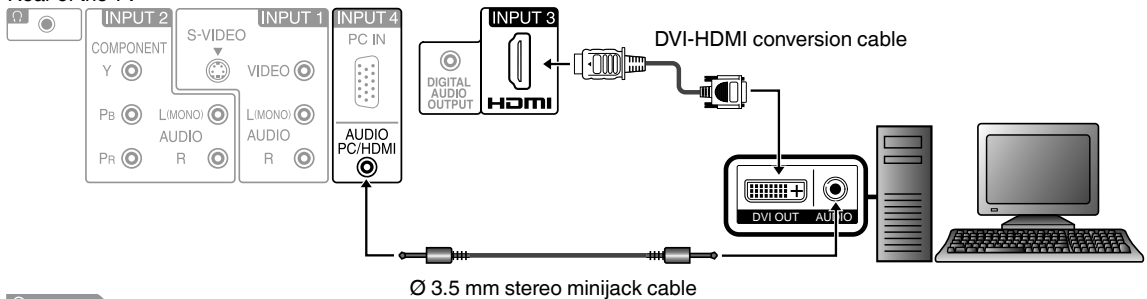

NOTE

- When using an DVI-HDMI conversion cable, you should make an analog audio connection. In this case, in addition to connecting an DVI-HDMI conversion cable to the INPUT 3 (HDMI) terminal, connect an audio cable to the AUDIO PC/HDMI terminal and set "HDMI Audio" to "DVI". (See page 28.)

Connecting to External Equipment

■ When using analog RGB cable (INPUT 4):

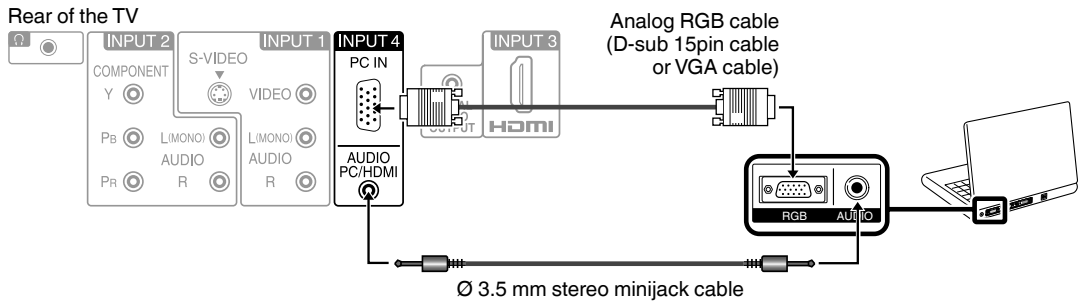

NOTE

- When using an analog RGB cable, input the audio signal to the AUDIO PC/HDMI terminal of INPUT 4.

Displaying an image from a PC

To view an image from a PC, perform the following procedure.

- ① Select the Input 4 (PC) mode using **INPUT** on the remote control or the TV/DVD set. (See page 15.)
- ② Select the PC input signal.
- ③ Adjust the "Picture" items if the PC image does not come in clearly. (See page 28.)

PC compatibility chart

PC	Resolution		Horizontal Frequency	Vertical Frequency	VESA Standard
PC	VGA	720 x 400	31.5 kHz	70 Hz	-
			31.5 kHz	60 Hz	○
		640 x 480	37.9 kHz	72 Hz	○
			37.5 kHz	75 Hz	○
	SVGA	800 x 600	35.1 kHz	56 Hz	○
			37.9 kHz	60 Hz	○
			48.1 kHz	72 Hz	○
			46.9 kHz	75 Hz	○
	XGA	1,024 x 768	48.4 kHz	60 Hz	○
			56.5 kHz	70 Hz	○
			60.0 kHz	75 Hz	○
	WXGA	1,280 x 768	47.8 kHz	60 Hz	○
47.7 kHz			60 Hz	○	

Watching TV

Preparation

Perform the following steps before you press **POWER** on the remote control unit.

- 1 Insert the batteries into the remote control unit. (See page 10.)
- 2 Connect the antenna cable to the TV/DVD. (See page 14.)
- 3 Plug in the AC cord to the AC outlet. (See page 9.)

Turning on the power

Press **POWER** on the TV/DVD, or **POWER** on the remote control.

TV status indicator (POWER)

ON	Lighting (Green)
OFF/Standby	Lighting (Red)

- **POWER** indicator (Green): The TV/DVD is on. ("Please wait" will appear for a few seconds on the screen.)

Auto Setup

The Auto Setup menu appears the first time you turn on the TV/DVD, and assists you to select the menu language, specify the Air/Cable setting, and program your channels automatically.

IMPORTANT: Make sure that the antenna or cable TV system connection is made!

- 1 The turn on the TV/DVD, press **POWER** (POWER indicator on the front of the unit changes green. It may take approx. 10 seconds for a picture to appear on screen.).
- 2 The "Auto Setup" function begins. Press **◀/▶** to select your desired language.
- 3 Press **▲/▼** to select "Signal Type", then press **◀/▶** to select "Cable" or "Air".
Air: VHF/UHF channels
Cable: CABLE TV channels
- 4 Press **▲/▼** to select "Automatic Search", then press **▶** or **ENTER**.
- 5 The TV will begin memorizing all the channels available in your area.
 - It may take from 15 minutes to 30 minutes to complete memorizing digital cable channels.
Depending on the reception condition, a bar display may not advance for several minutes, please be patient.

NOTE

- If you press **ENTER** in the process of "Auto Setup", the Auto Setup stops and changes to the normal screen.
- When you make a menu selection, your changes occur immediately. You do not have to press **EXIT** to see your changes.

Select the TV mode

Press **TV/DVD** to select the TV mode.

Turning off the power

Press **POWER** on the TV/DVD, or **POWER** on the remote control.

- The TV/DVD enters standby mode and the image on the screen disappears.
- The **POWER** indicator on the TV/DVD changes to Red.

NOTE

- If you are not going to use this TV/DVD for a long period of time, be sure to remove the AC cord from the power outlet.
- Weak electric power is still consumed even when the power is turned off.

Changing channels

You can change channels in several ways.

Method 1

Using **CH** **^/▼** on the remote control unit or on the TV/DVD.

NOTE

- If your cable-TV system includes analog and digital channels using the same channel number, your channel up function will scroll through the analog channel first, then the digital channel. Although it may appear as though the channel does not change, it actually moves from the analog to the digital channel in sequence.
If you use channel-down, it will move in reverse, from the digital channel to the analog channel.

Method 2

Using remote control buttons **0–9**, **• (DOT)** to select channels for VHF/UHF/CATV/DIGITAL, then press **ENTER**.

To select a 1 or 2-digit channel number (e. g., Channel 5):
Press **5**

NOTE

- When selecting a 1-digit channel number, it is not necessary to press **0** before the number.
- When you enter **0–9** only, channel selection will be made if there is no operation within a few seconds.

To select a 3-digit channel number (e. g., Channel 115):
Press **1→1→5**

To select a 4-digit channel number (e. g., Channel 22.1):
Press **2→2→• (DOT)→1**

NOTE

- When you enter **0–9** only, channel selection will be made if there is no operation within a few seconds.
- If you press **0** by itself in "Air" reception, nothing will happen.
- Complete the above steps within a few seconds.
- When you enter **0–9** and **• (DOT)**, channel selection will be made if there is no operation within a few seconds.

Watching TV

Auto Ch Memory

Auto Ch Memory makes the TV/DVD look for all channels viewable in the set area.

- 1 Press **TV MENU** and the MENU screen displays.
- 2 Press **▲/▼** to select "Channel", then press **▶** or **ENTER**. Press **▲/▼** to select "Auto Ch Memory", then press **▶** or **ENTER**.
- 3 Press **▲/▼** to select "Signal Type", then press **◀/▶** to select "Cable" or "Air".
- 4 Press **▲/▼** to select "Automatic Search", then press **▶** or **ENTER**.
- 5 The TV will begin memorizing all the channels available in your area.
 - It may take from 15 minutes to 30 minutes to complete memorizing digital cable channels. Depending on the reception condition, a bar display may not advance for several minutes, please be patient.

NOTE

- Memorizing channels is best accomplished during evening "PRIMETIME" hours, as more stations are broadcasting digital signals. Memorizing channels can only be accomplished while a station is broadcasting a digital signal to set that channel into memory.
- New digital channels may be added to your area periodically, it is recommended to perform the "Automatic Search" procedure regularly.

Skipping stored channel

You can set channel selection disabled using **CH ▲/▼**.

- 1 Press **TV MENU** and the MENU screen displays.
- 2 Press **▲/▼** to select "Channel", then press **▶** or **ENTER**.
- 3 Press **▲/▼** to select "Add/Delete", then press **▶** or **ENTER**.
- 4 Press **▲/▼** to select "Add/Delete", then press **▶** or **ENTER**.
- 5 Press **▲/▼** to select the channel that you want to skip.
- 6 Press **◀/▶** to select "Delete" for selected channel.
- 7 Press **EXIT** to return to the normal screen.

NOTE

- **To add a digital channel you are watching:** Select a channel you want to add. Then select "Adding Channel" in step 4, press **▶** or **ENTER**.
- **To release the skipping channel:** Select "Add" in step 6.

Clear All

All channels are deleted from the channel memory.

- 1 Press **TV MENU** and the MENU screen displays.
- 2 Press **▲/▼** to select "Channel", then press **▶** or **ENTER**.
- 3 Press **▲/▼** to select "Add/Delete", then press **▶** or **ENTER**.
- 4 Press **▲/▼** to select "Clear All", then press **▶** or **ENTER**.
- 5 Press **EXIT** to return to the normal screen.

Display the channel information

Press **DISPLAY** to display the current channel (or input source) information on the screen.

When the TV receives a digital signal, the digital information will appear for a few seconds.

- Channel number
- Channel label (if preset)
- V-Chip rating
- Sleep timer
- Program guide
- Resolution
- Station name
- Broadcast program name
- Signal type
- Audio language
- Picture size

When the TV receives an analog signal, the analog information will appear.

- Channel number
- V-Chip rating
- Sleep timer
- Picture size
- Channel label (if preset)
- Signal type
- Audio information (Stereo, SAP or Mono)
- Resolution
- Broadcast program name

Setting MTS/SAP stereo mode

The TV/DVD has a feature that allows reception of sound other than the main audio for the program. This feature is called Multi-channel Television Sound (MTS). The TV/DVD with MTS can receive mono sound, stereo sound and Secondary Audio Programs (SAP). The SAP feature allows a TV/DVD station to broadcast other information, which could be audio in another language or something completely different like weather information.

You can enjoy Hi-Fi stereo sound or SAP broadcasts where available.

- **Stereo broadcasts**
View programs like live sporting events, shows and concerts in dynamic stereo sound.
- **SAP broadcasts**
Receive TV broadcasts in either MAIN or SAP sound. MAIN sound: The normal program soundtrack (either in mono or stereo). SAP sound: Listen to a second language, supplementary commentary or other information. (SAP is mono sound.)

If stereo sound is difficult to hear.

- Obtain a clearer sound by manually switching to fixed mono-sound mode.

NOTE

- MTS only operates while in TV mode.
- MTS is available only when receiving analog broadcasting, not when receiving digital broadcasting.
- When the TV receives a stereo or SAP broadcast, the word "Stereo" or "SAP" displays on-screen if you press **DISPLAY**.

Changing MTS

You can change MTS as shown below to match the television broadcast signal.

- 1 In analog TV mode, press **AUDIO** and the "Audio" menu screen displays. "MTS" will be highlighted.
- 2 Press **AUDIO** again or **◀/▶** to select "Stereo", "SAP" or "Mono".
- 3 Press **EXIT** to return to the normal screen.

Watching TV

Selecting the digital audio language

When two or more audio languages are included in a digital signal, you can select one of the audio languages.

- 1 In digital TV mode, press **AUDIO** and the "Audio Language" menu screen displays.
- 2 Press **▲/▼** or **0-6** to select your desired language.
- 3 Press **EXIT** to return to the normal screen.

NOTE

- Digital audio is active only when receiving digital broadcasting, not when receiving analog broadcasting.

View mode for 4:3 programs

- 1 Press **VIEW MODE**.
 - The View mode menu displays.
 - The menu lists the view mode options selectable for the type of video signal currently being received.
- 2 Press **0-3** to select each view mode directly while the View mode menu is still on the screen.
 - Each time **VIEW MODE** is pressed, View Mode item toggles.
 - You can also select View Mode item by pressing **▲/▼**.
 - You can sequentially select a view mode that has its own aspect ratio.

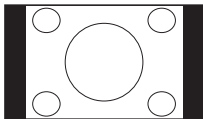

Side Bar:

Suitable for viewing conventional 4:3 programs in their normal format.

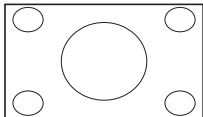

S.Stretch (Smart stretch):

Suitable for stretching 4:3 programs to fill the screen.

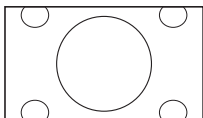

Zoom:

Suitable for viewing wide-screen 2.35:1 anamorphic DVDs in full screen.

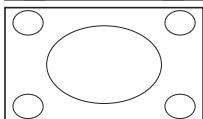

Stretch:

This mode is useful for 1.78:1 DVDs. When viewing 1.85:1 DVDs, stretch mode will still show very thin black bands at the top and bottom of the screen.

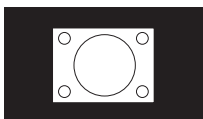

Dot by Dot (for PC/HDMI mode only):

Detects the resolution of the signal of the PC image and it will be shown on the screen with same amount of pixels.

NOTE

- You can enter to the same menu screen from "Picture" menu.
- You cannot select "Side Bar" and "S.Stretch" when a 720p, 1080i or 1080p signal is being input.
- Some High Definition and/or Digital broadcasts may not allow you to change the picture size.
- In PC Mode, only the "Side Bar", "Stretch" and "Dot by Dot" picture size features are available. In PC Mode (WXGA), only the "Stretch" and "Dot by Dot" picture size features are available.

View mode for HD programs

Stretch mode is available for HD programs.

Suitable for viewing wide-screen 1.78:1 aspect-ratio programs. When viewing 1.85:1 programs, the stretch mode will still show very thin black bands at the top and bottom of the screen.

Labeling channels

To create channel labels

- 1 Select a channel you want to label.
- 2 Press **TV MENU**, then press **▲/▼** to select "Channel", then press **▶** or **ENTER**. Press **▲/▼** to select "Ch Label", then press **▶** or **ENTER**. The Ch Label menu will appear.
- 3 Press **◀/▶** to select a channel you want to label, then press **▼**.

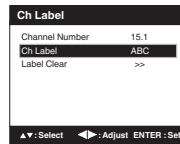

- 4 Press **◀/▶** repeatedly until the character you want appears in the first space.

The characters rotation as follows:

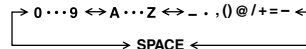

If the character which you desire appears, press **ENTER**. Repeat this step to enter the rest of the characters.

When you finish inputting the label name, press **ENTER**.

- 5 Press **EXIT** to return to the normal screen.
- 6 Repeat steps 1-5 for other channels. You can assign a label to each channel.

To erase channel labels

- 1 Select a channel with a label which you want to remove.
- 2 Press **TV MENU**, then press **▲/▼** to select "Channel", then press **▶** or **ENTER**. Press **▲/▼** to select "Ch Label", then press **▶** or **ENTER** to display the Ch Label menu.
- 3 Press **▲/▼** to select "Label Clear". Press **▶** or **ENTER**.
- 4 Press **EXIT** to return to the normal screen.
- 5 Repeat steps 1-4 to erase other channel labels.

Closed captions and digital closed captions

NOTE

- Closed Caption might not appear according to the condition of the signal from the broadcasting station.

Your TV/DVD is equipped with an internal Closed Caption decoder. It allows you to view conversations, narration and sound effects as subtitles on your TV/DVD. Closed Captions are available on some TV programs and on some VHS home video tapes at the discretion of the program provider.

Digital Closed Caption service is a new caption service available only on digital TV programs (also at the discretion of the service provider). It is a more flexible system than the original Closed Caption system, because it allows a variety of caption sizes and font styles. When the Digital Closed Caption service is in use, it will be indicated by the appearance of a 3-letter abbreviation that also indicates the language of the Digital Closed Captions: ENG (English), SPA (Spanish), FRA (French) or other language codes.

Not all programs and VHS videotapes offer closed captions. Please look for the “**CC**” symbol to ensure that captions will be shown.

In the Closed Caption system, there can be more than one caption service provided. Each is identified by its own number. The “C1” and “C2” services display subtitles of TV programs superimposed over the program’s picture. Generally, Closed Captions in English are transmitted on C1 and Closed Captions in other languages are transmitted on C2.

In the Closed Caption system, the “T1” or “T2” services display text that is unrelated to the program being viewed (e.g., weather or news). These services are also superimposed over the program currently being viewed.

NOTE

- If the program or video you selected is not closed-captioned, no captions will display on-screen.
- If text is not available in your viewing area, a black rectangle may appear on-screen. If this happens, setting the “CC Setting” to “Off”.
- When selecting Closed Captions, the captioning will be delayed approx. 10 seconds.
- If no caption signal is received, no captions will appear, but the television will remain in the Caption Mode.
- Misspellings or unusual characters may occasionally appear during Closed Captioning. This is normal with Closed Captioning, especially with live programs. This is because during live programs, captions are also entered live. These transmissions do not allow time for editing.
- When Captions are being displayed, on-screen displays, such as volume and mute may be seen but may interfere with Closed Captions.
- Some Cable TV systems and copy protection systems may interfere with the Closed Captioned signal.
- If using an indoor antenna or if TV reception is very poor, the Closed Caption Decoder may not appear or may appear with strange characters or misspelled words. In this case, adjust the antenna for better reception or use an outdoor antenna.
- When a Digital TV Program has both Digital Closed Caption and Analog Closed Caption signals, Digital Closed Caption is displayed.

- 1 Tune the TV to the desired program.
- 2 Press **TV MENU** and the MENU screen displays.
- 3 Press **▲/▼** to select “Setup”, then press **▶** or **ENTER**.
- 4 Press **▲/▼** to select “Closed Caption”, then press **▶** or **ENTER**.
The Closed Caption menu will appear.
- 5 Press **◀/▶** to setting the “CC Setting” to “On”.
- 6 Press **▲/▼** to select “Analog Caption” or “Digital Caption”.

When you select “Analog Caption”, you can choose from C1, C2, C3, C4, T1, T2, T3 and T4.

When you select “Digital Caption”, you can choose from CS1, CS2, CS3, CS4, CS5 and CS6.

- 7 Press **◀/▶** to select the desired Closed Caption mode for both Analog and Digital Caption.
- 8 Press **▲/▼** to select “CC Priority”, then press **◀/▶** to select “Digital CC” or “Analog CC”.
 - Depending on the broadcast signal, some Analog Captions will function with a Digital broadcast signal. This step prevent that two kind of captions are overlapping.
- 9 Press **EXIT** to return to the normal screen.

NOTE

- To turn the Closed Caption feature off, setting the “CC Setting” to “Off”.

Caption setup

This function allows you to adjust the closed caption screen appearance to suit your preference.

- 1 Press **TV MENU** and the MENU screen displays.
- 2 Press **▲/▼** to select "Setup", then press **▶** or **ENTER**.
- 3 Press **▲/▼** to select "Closed Caption", then press **▶** or **ENTER**.
The Closed Caption menu displays.
- 4 Press **▲/▼** to select "Digital CC Preset", then press **◀/▶** to select "Custom".
- 5 Press **▲/▼** to select "CC Advanced", then press **▶** or **ENTER**.
- 6 Press **▲/▼** to select the desired item, then press **◀/▶** to change the setting.
- 7 Press **EXIT** to return to the normal screen.

Selectable parameters available in each adjustment item.

Item	Selectable parameter
Text Size:	Auto, Small, Standard, Large
Text Type:	Auto, Style1, Style2, Style3, Style4, Style5, Style6, Style7
Text Edge:	Auto, None, Raised, Depressed, Uniform, Left Shadow, Right Shadow
Text Color:	Auto, Black, White, Red, Green, Blue, Yellow, Magenta, Cyan
Text Opacity:	Auto, Solid, Transparent, Translucent, Flashing
Background Color:	Auto, Black, White, Red, Green, Blue, Yellow, Magenta, Cyan
Background Opacity:	Auto, Solid, Transparent, Translucent, Flashing

 **NOTE**

- This feature is designed to customize Digital Captions only.
- The "Auto" value depends on the broadcasting station.
- You cannot set both "Text Color" and "Background Color" as a same color.
- You cannot set both "Text Opacity" and "Background Opacity" to "Transparent".

Password setting for parental control

Allows you to use a password to protect certain settings from being accidentally changed.

IMPORTANT:

Three conditions must be met to enable the V-Chip

- ① Password is registered.
- ② V-Chip settings have been made.
- ③ "V-Chip" is set to "On".

Setting a password

- 1 Press **TV MENU** and the MENU screen displays.
- 2 Press **▲/▼** to select "Lock", then press **▶** or **ENTER**.
- 3 Select and enter a password (4 digits) using the **0-9**, then press **ENTER**.
• "*" appears instead of the number.
- 4 Enter the same password again to confirm, then press **ENTER**, the password is now registered and the Lock menu will appear on the screen.

Changing the password

Allows you to change your current password.

- 1 Repeat steps 1 to 3 in **Setting a password**.
- 2 Press **▲/▼** to select "Change Password", then press **▶** or **ENTER**.
- 3 Enter a new password using **0-9**, then press **ENTER**.
- 4 Enter the same password again to confirm, then press **ENTER**.
- 5 The screen returns to Lock menu. Your new password has been set.

 **NOTE**

- As a precautionary measure, make a note of your password and keep it in a familiar place.
- The "V-Chip Set (DTV)" will only be selectable when a new rating system can be downloaded via digital broadcasting in the U.S.

How to enter the Lock menu

- 1 Press **TV MENU** and the MENU screen displays.
- 2 Press **▲/▼** to select "Lock", then press **▶** or **ENTER**.
- 3 Input the 4-digit password by using **0-9**, then press **ENTER**.
The Lock menu displays.

To clear the all V-Chip settings

- 1 In the Lock menu, press **▲/▼** to select "V-Chip Clear", then press **▶** or **ENTER**.
- 2 Input the 4-digit password by using **0-9**, then press **ENTER**. All your settings return to the factory settings.

Watching TV

Parental control (V-CHIP)

V-CHIP might not function according to the condition of the signal from the broadcasting station.

V-CHIP is an electronic filtering device built into your TV/DVD. This tool gives parents a great degree of control over broadcasts accessed by their children. It allows parents to select programs judged suitable for child viewing while blocking ones judged not suitable. It does so automatically once you activate the V-CHIP feature in your TV/DVD.

V-CHIP menu will not be selectable from the menu if you do not first configure your password.
(See page 24 for password setting for parental control.)

- The U.S. has two rating systems for viewing content: movie ratings and TV Parental Guidelines.
- The TV Parental Guidelines work in conjunction with the V-CHIP to help parents screen out inappropriate television shows from their children.
- Movie ratings are used for original movies rated by the Motion Picture Association of America (MPAA) as watched on cable TV and not edited for television. The V-CHIP can also be set to block MPAA-rated movies.

TV Parental Guidelines

TV RATING		Content				
		FANTASY VIOLENCE	VIOLENCE	SEXUAL SITUATIONS	ADULT LANGUAGE	SEXUAL DIALOG
Suggested age	TV-Y (All children)	☒	☒	☒	☒	☒
	TV-Y7 (Directed to older children)	X	☒	☒	☒	☒
	TV-G (General audience)		☒	☒	☒	☒
	TV-PG (Parental Guidance suggested)		X	X	X	X
	TV-14 (Parents strongly cautioned)		X	X	X	X
	TV-MA (Mature audience only)		X	X	X	X

☒: The content rating can be set, but this rating is not normally broadcast by TV stations.

X: Content rating can be set.

EXAMPLE

- If you select “TV-G”, this will automatically block the higher ratings “TV-PG”, “TV-14” and “TV-MA”.

Voluntary movie rating system (MPAA)

MOVIE RATING	Description
G	General audiences. All ages admitted.
PG	Parental guidance suggested. Some material may not be suitable for children.
PG-13	Parents strongly cautioned. Some material may be inappropriate for children under 13.
R	Restricted. Under 17 requires accompanying parent or adult guardian (age varies in some jurisdictions).
NC-17	No one 17 and under admitted.
X	X is an older rating that is unified with NC-17 but may be encoded in the data of older movies.

EXAMPLE

- If you select “PG-13”, this will automatically block the higher ratings “R”, “NC-17” and “X”.

NOTE

- Voluntary movie rating system only uses an age-based rating.

TV Parental Guidelines (TV Guidelines)

- 1 In Lock menu, press ▲/▼ to select “V-Chip”, then press ◀/▶ to select “On”.
- 2 Press ▲/▼ to select “V-Chip Set”, then press ▶ or **ENTER**.
- 3 Press ▲/▼ to select “TV Rating”, then press ▶ or **ENTER**.
- 4 Press ▲/▼/◀/▶ to select the desired rating, then press **ENTER**.
- 5 Press **EXIT** to return to the normal screen.

Voluntary movie rating system (MPAA)

- 1 Repeat steps 1 and 2 in **TV Parental Guidelines (TV Guidelines)**.
- 2 Press ▲/▼ to select “Movie Rating”, then press ▶ or **ENTER**.
- 3 Press ▲/▼ to select the desired rating, then press **ENTER**.
- 4 Press **EXIT** to return to the normal screen.

Watching TV

Canadian rating systems

- The TV rating systems in Canada are based on the Canadian Radio-Television and Telecommunications Commission (CRTC) policy on violence in television programming.
- While violence is the most important content element to be rated, the structure developed takes into consideration other program content like language, nudity, sexuality and mature themes.
- When setting the V-CHIP on the Canadian system you can choose either the Canadian English ratings or the Canadian French ratings.

Canadian English ratings

Rating	Description	
Age	E	Exempt: Includes news, sports, documentaries and other information programming; talk shows, music videos, and variety programming.
	C	Children: Intended for younger children under the age of 8 years. Pays careful attention to themes that could threaten their sense of security and well-being.
	C8+	Children over 8 years old: Contains no portrayal of violence as the preferred, acceptable, or only way to resolve conflict; nor encourage children to imitate dangerous acts which they may see on the screen.
	G	General: Considered acceptable for all age groups. Appropriate viewing for the entire family, contains very little violence, physical, verbal or emotional.
	PG	Parental Guidance: Intended for a general audience, but may not be suitable for younger children (under the age of 8) because it could contain controversial themes or issues.
	14+	Over 14 Years: Could contain themes where violence is one of the dominant elements of the storyline, but it must be integral to the development of plot or character. Language usage could be profane and nudity present within the context of the theme.
	18+	Adults: Intended for viewers 18 years and older and might contain depictions of violence, which while related to the development of plot, character or themes, are intended for adult viewing. Could contain graphic language and portrayals of sex and nudity.

Example: If you select “G”, this will automatically block the higher ratings “PG”, “14+” and “18+”.

Canadian French ratings

Rating	Description	
Age	E	Exempt programming.
	G	General: All ages and children, contains minimal direct violence, but may be integrated into the plot in a humorous or unrealistic manner.
	8 ans+	General but inadvisable for young children: May be viewed by a wide public audience, but could contain scenes disturbing to children under 8 who cannot distinguish between imaginary and real situations. Recommended for viewing with parent.
	13 ans+	Over 13 years: Could contain scenes of frequent violent scenes and therefore recommended for viewing with parent.
	16 ans+	Over 16 years: Could contain frequent violent scenes and intense violence.
	18 ans+	Over 18 years: Only for adult viewing. Could contain frequent violent scenes and extreme violence.

Example: If you select “8 ans+”, this will automatically block the higher ratings “13 ans+”, “16 ans+” and “18 ans+”.

Canadian English ratings

- 1 Repeat steps 1 and 2 in **TV Parental Guidelines (TV Guidelines)**.
- 2 Select “CAN ENG Rating”, then press ► or **ENTER**. Press ▲/▼ to select E, C, C8+, G, PG, 14+ or 18+, then press **ENTER**.
- 3 Press **EXIT** to return to the normal screen.

How to temporarily release the V-Chip block

The V-Chip block is working and censors a broadcast, “This program has been blocked!” displays.

- 1 Press **MUTE** while the V-Chip is working and then the password entering menu displays.
- 2 Enter your 4-digit password with **0–9**, then press **ENTER**.
At this time V-Chip block temporarily releases.

Canadian French ratings

- 1 Repeat steps 1 and 2 in **TV Parental Guidelines (TV Guidelines)**.
- 2 Select “CAN FRE Rating”, then press ► or **ENTER**. Press ▲/▼ to select E, G, 8 ans+, 13 ans+, 16 ans+ or 18 ans+, then press **ENTER**.
- 3 Press **EXIT** to return to the normal screen.

Reactivating the temporarily released V-Chip block

Method 1: Change to the other channel.

Method 2: Switch off the TV power.

NOTE

- Performing any of the two above will activate the V-Chip block.

Other convenience functions

Menu operation buttons

Use the following buttons on the remote control to operate the menu.

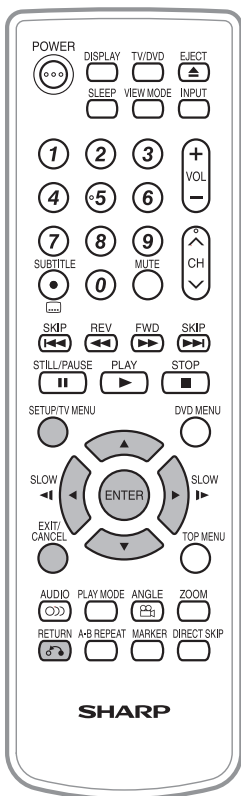

Quick guide for MENU operation

example : Select Language

1 Press **TV MENU** and the MENU screen displays.



2 Press **▲/▼** to select "Setup", then press **▶** or **ENTER**.

Press **▲/▼** to select "Language".

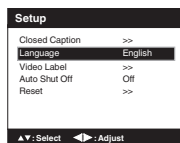

3 Press **◀/▶** to select the desired language.
...on the following pages the MENU can be called in the same way as here.

4 Press **EXIT** to return to the normal screen.

NOTE

- Some menu items may not displayed depending on the selected input source.
- If no buttons are pressed for more than approx. 60 seconds, the menu screen will return to normal screen automatically.

TV MENU: Press to open the menu screen.

▲/▼/◀/▶: Press to select a desired item on the screen or adjust a selected item.

ENTER: Press to go to the next step or complete the setting.





RETURN: Press to return to the previous step.

EXIT: Press to exit from the menu screen.
All changed settings will be saved.

▲▼: Select ◀▶: Adjust ENTER: Set

The lower part of the menu screen is an operational guide for the remote control. It will change in accordance with each menu setting screen.

Other convenience functions

Icon	Selected item		Description
	Picture Setting	Brightness / Contrast / Sharpness / Color / Tint	You can adjust the picture quality to your preference.
		Color Temperature	Bluish (Cool) / Neutral (Standard) / Reddish (Warm)
		Backlight	Backlight adjusts the screen brightness for improved picture clarity.
	DBC	On / Off	Use this feature to change the Black level automatically according to the brightness of an image. The Black level will become dark in a dark scene.
	AV Mode	Sports	For a clear-cut image emphasizing high contrast, useful for sports viewing.
		Standard	For a highly defined image in a normal lighting.
		Movie	For a movie.
		Memory	Allows the user to customize settings as desired. You can set the mode for each input source.
	View Mode	See page 22.	
	Film Mode	On / Off	A smoother motion may be obtained by setting the Film Mode to "On" when you view a DVD from the DVD player.
	PC Setting* (see pages 18, 19)	Hor Position / Ver Position	
Clock		To minimize any vertical bars or stripes visible on the screen background.	
Phase		This must be adjusted after the frequency has been set optimize picture quality.	
Auto Adjust		To adjust the all PC settings automatically.	
DNR	On / Off	DNR (Digital Noise Reduction) can reduce the roughness of the picture.	
	Bass / Treble / Balance		You can adjust the sound quality to your preference.
	MTS	Stereo / SAP / Mono	See page 21.
	Surround	On / Off	The dynamic presence and sound created offers a thoroughly enjoyable listening experience.
	Audio Language		When two or more audio languages are included in a digital signal, you can select one of the audio languages.
	HDMI Audio	HDMI	When you connect the HDMI device to the TV/DVD, select this setting.
DVI		When you connect the DVI device to the TV/DVD with analog audio cords, select this setting.	
	Add/Delete	Adding Channel / Add/Delete / Clear All	See page 21.
	DTV Signal		Select "DTV Signal", then press ► or ENTER . The Digital-Signal strength screen will appear. If necessary, adjust the direction of the antenna to obtain the maximum signal strength.
	Auto Ch Memory	Signal Type / Automatic Search	See page 21.
	Ch Label	Channel Number / Ch Label / Label Clear	See page 22.
	Lock		See pages 24~26.
	Closed Caption		See page 23.
	Language	English / Français / Español	You can choose from three different languages (English, French and Spanish) for the on-screen displays.
	Video Label		Let you set the input terminal displayed when using the "Input Select" menu or channel display. Press ▲/▼ to select the specific input source which you want to change. Press ◀/▶ to select the new label for the selected input source.
	Auto Shut Off	On / Off	In case of "Auto Shut Off" feature is "On", if a station being viewed stops broadcasting, the TV/DVD will automatically shut itself off after 15 minutes. <ul style="list-style-type: none"> If Auto Shut Off is "On" and the broadcast signal is weak, the TV/DVD may automatically shut itself off. If this happens, turn Auto Shut Off to "Off".
	Reset		The Reset function returns your settings to the factory settings.

NOTE

- * "PC Setting" is available only for PC INPUT (INPUT 4).
- * When you connect the PC via HDMI input, you can setting "Hor Position" and "Ver Position" only.
- * Whenever you change the PC display resolution settings and find that the characters of the PC input has rough edges or has some flickerings, please go to PC Setting and do an "Auto Adjust" to improve the display of the PC input.

Watching the DVD

Preparation

Perform the following steps before you press **POWER** on the remote control unit.

- 1 Insert the batteries into the remote control unit. (See page 10.)
- 2 Plug in the AC cord to the AC outlet. (See page 9.)

Turning on the power

Press **POWER** on the TV/DVD, or **POWER** on the remote control.

- **POWER** indicator (Green): The TV/DVD is on. ("Please wait" will appear for a few seconds on the screen.)

Select the DVD mode

Press **TV/DVD** to select the DVD mode.

Turning off the power

Press **POWER** on the TV/DVD, or **POWER** on the remote control.

- The TV/DVD enters standby mode and the image on the screen disappears.
- The **POWER** indicator on the TV/DVD changes to Red.

NOTE

- If you are not going to use this TV/DVD for a long period of time, be sure to remove the AC cord from the power outlet.
- Weak electric power is still consumed even when the power is turned off.

Playback procedure

- 1 Place the disc in the disc slot with the label side facing forward. (If the disc has a label.) Hold the disc without touching its surface, align it with the guides, and place it in position.
 - If a disc is inserted during some modes other than DVD mode, it may switch to DVD mode and then playback may be begun automatically.

NOTE

- If a non-compatible disc is loaded, "Can't play disc" or "Incompatible disc region number Can't play disc" will appear on the TV screen according to the type of loaded disc. In this case, check your disc again (see pages 6 and 36).
- Some discs may take a minute or so to start playback.
- When an 8 cm disc is placed into the disc slot, and the playback picture or menu display does not appear, press **PLAY**.
- A prohibition message "Depending on the disc, this operation may be prohibited" or "This operation can't be performed" may appear at the screen. This message means either the feature you tried is not available on the disc, or the unit cannot access the feature at this time. This does not indicate a problem with the unit.
- When you set a single-faced disc label downwards (i.e. the wrong way up) "Loading" will appear on the display and then "Can't play disc" will be displayed.
- Some playback operations of DVDs may be intentionally fixed by software producers. Since this TV/DVD plays DVDs according to the disc content recorded, some playback features may not be available. Also refer to the instructions supplied with the DVDs.
- Do not move the unit during playback. Doing so may damage the disc.
- Use **EJECT** to unload and eject the disc.
- Do not put any objects other than discs on the disc slot. Doing so may cause the unit to malfunction.
- In many instances, a menu screen will appear after playback of a movie is completed. Prolonged display of an on-screen menu may damage your television set, permanently etching that image onto its screen. To avoid this, be sure to press **POWER** on your remote control once the movie is completed.
- There may be a slight delay between the button is pressed and the function activates.

- 2 On the screen, "▲" changes to "Loading" and then playback will commence.
 - A menu screen appear on the TV screen, if the disc has a menu feature. In this case, press ▲/▼/◀/▶ or **ENTER** to operate a menu feature.
- 3 Press **STOP** to end playback.
 - The unit can record where you stop a video, but it depends on a disc you are using. Press **PLAY** to resume a playback point. The unit can store a memory of stopped point of last five discs that you have played. When one of these discs is next loaded, you can resume playback from where you stopped playing last time.
 - If you press **STOP** again ("Resume off" appears on the screen), the TV/DVD will clear the stopped point.
 - It is only DVD videos that a stopped point can be stored in the unit with.
 - You cannot save a stopped point for some discs. If a number of discs played and stored in the unit exceeds five, a new memory will overwrite the old stored memory.
- 4 Press **EJECT**.
Remove the disc and then press **POWER**.
The TV/DVD turns off.
 - When you eject the disc, you may hear mechanism noise, but it is not malfunction.

Status display of DVD disc

Press **DISPLAY**. The status display of the disc will appear on the screen.

- Display messages may change at every time when you press **DISPLAY** for some discs or files.

NOTE

- **If the TV/DVD does not operate properly:**
Static electricity, etc., may affect the player's operation. Disconnect the AC power cord once, then connect it again.
- **About inserting disc:**
If the unit is slanted or moved while inserting disc, the disc may get damage.

Watching the DVD

Special playback

Fast Forward Playback

Press **FWD** during normal playback.

Each press of **FWD** will increase the speed of the search.

- To resume normal playback, press **PLAY**.

Review Playback

Press **REV** during normal playback.

Each press of **REV** will increase the speed of the search.

- To resume normal playback, press **PLAY**.

Still Playback

Press **STILL/PAUSE** during normal playback to pause playback.

- To resume normal playback, press **PLAY** or **STILL/PAUSE**.

Frame Advance

Press **STILL/PAUSE** during normal playback.

One frame is advanced each time you press **◀◀** or **▶▶**.

- To resume normal playback, press **PLAY**.

Slow-motion Playback

Press **SLOW (|▶)** or **SLOW (◀|)** during normal playback or still playback.

Each press of **SLOW** will change the speed of the slow.

- To resume normal playback, press **PLAY**.
- To resume the still playback, press **STILL/PAUSE**.

Locating a chapter or track

Press **SKIP(▶▶▶)** Forward or **SKIP(◀◀◀)** Reverse during playback to locate a chapter/track that you want to watch.

Each time you press the button, a chapter or track is skipped.

NOTE

- The TV/DVD is capable of holding a still video image or On screen display image on your television screen indefinitely. If you leave the still video image or On screen display image displayed on your TV for an extended period of time, you risk permanent damage to your television screen.

Zooming

This TV/DVD will allow you to zoom in on the frame image. You can then make selections by switching the position of the frame.

- 1 Press **ZOOM** during playback.
The center part of the image will be zoomed in.
Each press of **ZOOM** will change the ZOOM magnification Zoom 2x and Zoom 4x.
- 2 Press **▲/▼/◀/▶** to view a different part of the frame.
You may move the frame from the center position UP, DOWN, LEFT or RIGHT.
- 3 In the zoom mode press **ZOOM** repeatedly to return to a 1:1 view.

NOTE

- You can select the Still Playback or Fast Forward (Review) Playback in the zoom mode.
- Some discs may not respond to zoom feature.

Locating desired scene

Use the title, chapter and time recorded on the disc to locate the desired point to playback.

- 1 Press **DIRECT SKIP** during playback.
- 2 Press **▲/▼** to select the "Title Search", "Chapter Search", "Time Search" or "Track Search" (Audio CD), then press **ENTER**.
- 3 Press **Number buttons (0-9)**, then press **▶** or **ENTER** to input the number.
 - If you input a wrong number, press **CANCEL**.
 - Refer to the package supplied with the disc to check the numbers.
- 4 Press **ENTER**.
 - Playback starts.
 - When you change the title, playback starts from Chapter 1 of the selected title.
 - Some discs may not work in the above operation.

A-B Repeat playback

A-B repeat playback allows you to repeat material between two selected points.

- 1 Press **A-B REPEAT** during playback.
The start point is selected.
- 2 Press **A-B REPEAT** again.
The end point is selected.
Playback starts at the point that you selected.
Playback stops at the end point, returns to Point A automatically, then starts again.
 - To resume normal playback press **A-B REPEAT** again.

NOTE

- In A-B Repeat mode, subtitles near the A or B locations may not be displayed.
- You may not be able to set A-B Repeat during certain scenes of the DVD.
- A-B Repeat does not work with an interactive DVD, MP3/WMA/JPEG-CD.

Watching the DVD

Marking desired scenes

The TV/DVD stores the points that you want to watch again up to 12 points.

You can resume playback from each scene.

Marking the scenes

- 1 Press **MARKER** during playback.
- 2 Select the blank Marker using **▲/▼/◀/▶**, then press **ENTER** at the desired scene.
 - Up to 12 scenes can be selected.
 - Repeat this procedure to set the other 11 scenes.
- 3 Press **MARKER** to return to the normal screen.

Returning to the scenes

- 1 Press **MARKER** during playback or stop mode.
- 2 Press **▲/▼/◀/▶** to select the Marker 1-12.
- 3 Press **ENTER**.
Playback starts from the marked scene.

To cancel the Marker

Follow the above steps 1~2, then press **CANCEL**.

NOTE

- Some discs may not work with the marking operation.
- The marking is cancelled when you eject the disc or turn the power off.
- Some subtitles recorded around the marker may fail to appear.

Changing angles

When playing back a disc recorded with multi-angle facility, you can change the view angle.

- 1 Press **ANGLE** during playback.
The current angle will appear.



- 2 Press **ANGLE** repeatedly until the desired angle is selected.

NOTE

- In case of JPEG-playback, the JPEG-image is rotated 90 degrees to the right.
- Depending on the DVD, you may not be able to change the angles even if multi-angles are recorded on the DVD.

Changing soundtrack language

You can select the language when you play a multilingual disc.

- 1 Press **AUDIO** during playback.
The current soundtrack language will appear.

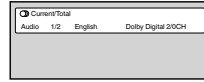

- 2 Press **AUDIO** repeatedly until the desired language is selected.
The on-screen display will disappear after a few seconds.

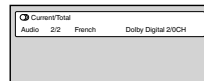

NOTE

- If the desired language is not heard after pressing **AUDIO** several times, the language is not recorded on the disc.
- Changing soundtrack language is cancelled after "Resume off".
The initial default language or available language will be heard if the disc is played back again.

Subtitles

Changing the subtitle language

You can select the language when playing back a disc recorded with multilingual subtitles.

- 1 Press **SUBTITLE** repeatedly during playback until your desired language appears.
The on-screen display will disappear after a few seconds.

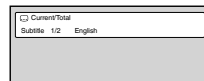

Turning the subtitles off

Press **SUBTITLE** during playback until "Off" appears.

NOTE

- Changing subtitle language is cancelled after "Resume off".
- Some functions may not work on some DVDs. You may not be able to turn subtitles on or off or change subtitles. While playing the DVD, the subtitle may change when:
 - you eject or insert the disc.
 - you change the title.
- In some cases, the subtitle language is not changed to the selected one immediately.

Using HOME MENU

Playing a disc

1 Press **SETUP** during stop mode. HOME MENU will appear.

2 Press **▲/▼/◀/▶** to select “Disc Navigator”, then press **ENTER**.



3 Press **▲/▼** to select desired option, then press **ENTER**.

- Some discs may not work Disc Navigator.
- Depending on a disc, you can select Title, Chapter, or both.

4 Press **▲/▼/◀/▶** or **Number Buttons (0-9)** to select Title or Chapter, then press **ENTER**.

- Press **SKIP (◀◀)** or **SKIP (▶▶)** to move previous/next page.
- Press **RETURN** to return to previous step.



Playing a file

1 Press **SETUP** during stop mode. HOME MENU will appear.

2 Press **▲/▼/◀/▶** to select “Disc Navigator”, then press **ENTER**.

3 Press **▲/▼** to select folder, then press **ENTER**.



4 Press **▲/▼** to select file, then press **ENTER**.

- If you select JPEG file, unit shows the pictures one after another automatically.
- Press **SETUP** to clear HOME MENU screen.
- Press **RETURN** to go to previous step.

NOTE

- When music files and JPEG files are recorded in one disc, you can play simultaneously. Please select the music file then select the JPEG file.

Play mode

A-B repeat playback

A-B repeat playback allows you to repeat selection between two selected points.

1 Press **PLAY MODE** during playback. Play Mode screen will appear.

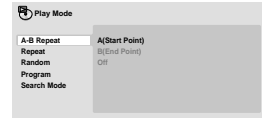

2 Press **▲/▼** to select “A-B Repeat”, then press **▶** or **ENTER**.

3 Press **▲/▼** to select “A(Start Point)”, then press **ENTER**. The start point is selected.

4 Press **▲/▼** to select “B(End Point)”, then press **ENTER**. The end point is selected. Playback starts at the point that you selected. Playback stops at the end point and returns to Point A automatically, then starts again.

To resume normal playback

Select “Off” in step 3.

NOTE

- Some discs may not work Play mode function.
- A-B Repeat playback does not work with MP3/WMA CD.

Repeat playback

1 Press **PLAY MODE** during playback. Play Mode screen will appear.

2 Press **▲/▼** to select “Repeat”, then press **▶** or **ENTER**.

3 Press **▲/▼** to select desired repeat option, then press **ENTER**. The unit automatically starts repeat playback after finishing the current title or chapter.

To resume normal playback

Select “Repeat Off” in step 3.

Random playback

1 Press **PLAY MODE** during playback. Play Mode screen will appear.

2 Press **▲/▼** to select “Random”, then press **▶** or **ENTER**.

3 Press **▲/▼** to select desired random playback option, then press **ENTER**. The unit automatically starts random playback.

To resume normal playback

Select “Random Off” in step 3.

NOTE

- You cannot play Random for programmed contents (Random play is not permitted during Program playback).
- During Random playback, it may repeat the same title, chapter or track.
- Random playback does not work with MP3/WMA CD.

Watching the DVD

Program playback

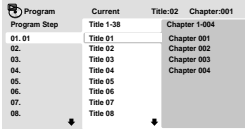
- 1 Press **PLAY MODE** during playback. Play Mode screen will appear.
- 2 Press **▲/▼** to select “Program”, then press **▶** or **ENTER**.
- 3 Press **▲/▼** to select “Create/Edit”, then press **ENTER**. “Create/Edit” display differs, depending on discs or files.

Program	Current	Title	Chapter
Program Step	Title 1-38	Chapter 1-004	
01. 01	Title 01	Chapter 001	
02.	Title 02	Chapter 002	
03.	Title 03	Chapter 003	
04.	Title 04	Chapter 004	
05.	Title 05		
06.	Title 06		
07.	Title 07		
08.	Title 08		
- 4 Press **▲/▼/◀/▶** to select Title, Chapter, Track or File, then press **ENTER**.
 - When you add a program, find where you want to add it (Program Step) and select Title, Chapter or Track then press **ENTER**. (It will be added to the left if File is added.)
 - To go to previous step, press **RETURN**.
 - To delete a program, select Program Step that you want to delete and press **CANCEL**.
- 5 Press **PLAY**.
 - To play existing programmed contents, select “Playback Start” from Play Mode screen and press **ENTER**.
 - To resume normal playback, select “Playback Stop” in Play Mode screen and press **ENTER**. Your programmed contents are saved.
 - To delete all programmed contents, select “Program Delete” in Play Mode screen and press **ENTER**.

NOTE

- You can repeat the programmed contents. Select “Program Repeat” from “Repeat” in the Play Mode screen during Program playback.
- You cannot play Random for programmed contents (Random play is not permitted during Program playback).
- In stop mode, you can also enter Play Mode screen by selecting “Play Mode” in HOME MENU.

Locating desired scene

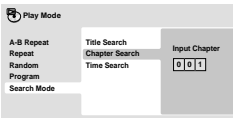
- 1 Press **PLAY MODE** during playback. Play Mode screen will appear.
- 2 Press **▲/▼** to select “Search Mode”, then press **▶** or **ENTER**.
- 3 Press **▲/▼** to select desired search mode option, then press **▶** or **ENTER**.
 - Search Mode options differs, depending on discs or files.
- 4 Input Title, Chapter, Track or Folder number or Time by using **Number buttons (0-9)** and press **ENTER**.

Play Mode	Title Search	Chapter Search	Input Chapter
A-B Repeat			
Repeat			
Random			
Program			
Search Mode			0 0 1

NOTE

- You can locate desired scene in Menu screen for some DVD video.
- In stop mode, you can also enter Play Mode screen by selecting “Play Mode” in HOME MENU.

Audio Settings menu

The Audio Settings menu offers features for adjusting the way discs sound.

- 1 Press **SETUP** during stop mode. HOME MENU will appear.
- 2 Press **▲/▼/◀/▶** to select “Audio Settings”, then press **ENTER**.
- 3 Press **▲/▼/◀/▶** to setting the option, then press **ENTER**.
- 4 Press **SETUP** to save the setting.

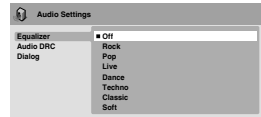
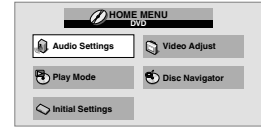

Equalizer

Select the most suitable setting to match a category of music that you are listening to.

Audio DRC

- Loud sound level goes down and quiet sound level goes up while playing. This is useful, for instance, when you watch a film in the late night.
- It only works with Dolby Digital Sound.
- The effect depends on your AV amplifier and speakers volume. Adjust the sound as you wish and find the most effective setting.

Dialog

Adjust setting when you cannot hear dialogs very well.

NOTE

- It may not be very effective for some discs or files.

Video Adjust menu

From the Video Adjust menu you can adjust various settings that affect how the picture is presented.

- 1 Press **SETUP** during stop mode. HOME MENU will appear.
- 2 Press **▲/▼/◀/▶** to select "Video Adjust", then press **ENTER**.
- 3 Press **▲/▼/◀/▶** to setting the option, then press **ENTER**.

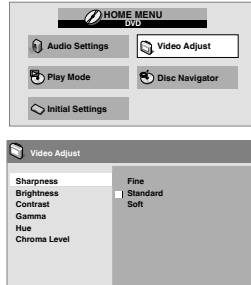

- 4 Press **SETUP** to save the setting.

Sharpness

Adjust sharpness of images.

Brightness

Adjust brightness of images.

Contrast

Adjust a ratio of brightness between the brightest part and the darkest part.

Gamma

Emphasize dark part of images.

Hue

Adjust a balance between green and red.

Chroma Level

Adjust color density. It is effective with animation or something with high color density.

NOTE

- It may not be very effective for some discs or files.

Customizing The Function Settings

You can change the default settings to customize performance to your preference.

Setting procedure

- 1 Press **SETUP** in stop mode. HOME MENU will appear.
- 2 Press **▲/▼/◀/▶** to select "Initial Settings", then press **ENTER**.



- 3 Press **▲/▼/◀/▶** to select the desired option, then press **ENTER**.
- 4 Change the selection using **▲/▼/◀/▶** or **ENTER**, by referring to the corresponding page 35. Repeat steps 3 and 4 to change other option.
- 5 To clear HOME MENU screen, press **SETUP**.

Function Setup

Customizing The Function Settings

Setting	Option	Description
Digital Audio Out settings		
Digital Out	On	Digital audio is output from the digital outputs.
	Off	No digital audio output.
Dolby Digital Out	Dolby Digital	Dolby Digital encoded digital audio is output when playing a Dolby Digital DVD disc.
	Dolby Digital > PCM	Dolby Digital audio is converted to PCM audio before being output.
DTS Out	DTS	DTS encoded digital audio is output when playing a DTS disc. (Noise will be output if your amplifier/receiver is not compatible with DTS audio.)
	Off	No digital audio is output.
96kHz PCM Out	96kHz > 48kHz	96 kHz digital audio is converted to 48 kHz for digital output.
	96kHz	96 kHz digital audio is output as is at 96 kHz.
MPEG Out	MPEG	MPEG encoded digital audio is output as is.
	MPEG > PCM	MPEG encoded digital audio is converted to PCM audio for digital output.
Video Output settings		
TV Screen	4:3 (Letter Box)	Set if you have a conventional 4:3 TV. Widescreen movies are shown with black bars top and bottom.
	4:3 (Pan & Scan)	Set if you have a conventional 4:3 TV. Widescreen movies are shown with the sides cropped so that the image fills the screen.
	16:9 (Wide)	Set if you have a widescreen TV.
Language settings		
Audio Language	English/French/Spanish	If there is an English, French or Spanish soundtrack on the disc, then it will be played.
	Other Language	Select to choose a language other than the ones displayed. (See Language Code List on page 37.)
Subtitle Language	English/French/Spanish	If there is an English, French or Spanish subtitle on the disc, then it will be displayed.
	Other Language	Select to choose a language other than the ones displayed. (see Language Code List on page 37.)
DVD Menu Lang.	w/Subtitle Lang.	DVD disc menus will be displayed in the same language as your selected subtitle language, if possible.
	English/French/Spanish	If there is an English, French or Spanish DVD menu language on the disc, then it will be displayed.
	Other Language	Select to choose a language other than the ones displayed. (see Language Code List on page 37.)
Subtitle Display	On	Subtitles are displayed according to your selected subtitle language (see above).
	Off	Subtitles are always off by default when you play a DVD disc (note that some discs override this setting).
Display settings		
Angle Indicator	On	A camera icon is displayed on-screen during multi-angle scenes on a DVD disc.
	Off	No multi-angle indication is shown.
Options settings		
Parental Lock		See page 36.

Function setup

Parental Control

Some discs are specified as not suitable for children. Such discs can be limited not to playback with the unit.

How to into the Parental menu

- 1 Press **SETUP** in stop mode. HOME MENU will appear.
- 2 Press **▲/▼/◀/▶** to select "Initial Settings", then press **ENTER**.
- 3 Press **▲/▼** to select "Options", then press **▶** or **ENTER**. Then press **▶** or **ENTER** to enter the Parental Lock menu.



Set Password

- 1 Press **▲** or **▼** to select "Password", then press **ENTER**.
- 2 Press **Number buttons (0-9)** to input the password, then press **ENTER**.

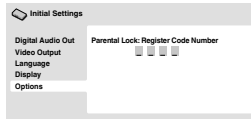
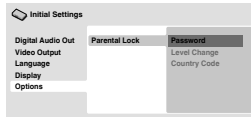

Change Password

- 1 Press **▲** or **▼** to select "Password Change", then press **ENTER**.
- 2 Press **Number buttons (0-9)** to input the current password, then press **ENTER**.
- 3 Press **Number buttons (0-9)** to input the new password. Press **ENTER**. Now your new password has been set. Be sure to remember this number!

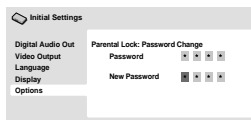
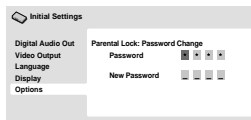
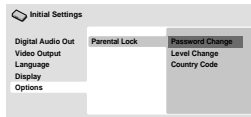

Level Change

- 1 Press **▲** or **▼** to select "Level Change", then press **ENTER**.
- 2 Press **Number buttons (0-9)** to input the current password, then press **ENTER**.
- 3 Press **◀** or **▶** to select from the level 1 to level 8. The limitation will be more severe as the level number is lower. Then press **ENTER**.

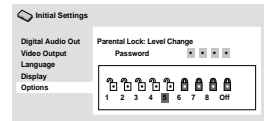
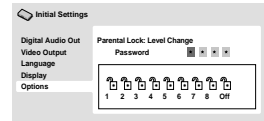
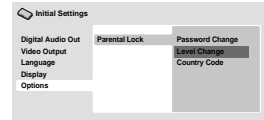

- Level 1:** DVD software for adults cannot be played back.
- Level 8:** Virtually all DVD software can be played back.
- Level Off:** The parental control setting does not function.

Country Code

- 1 Press **▲** or **▼** to select "Country Code", then press **ENTER**.
- 2 Press **Number buttons (0-9)** to input the current password, then press **ENTER**.
- 3 Press **▲** or **▼** to select the input mode from "Country Code List" or "Code".

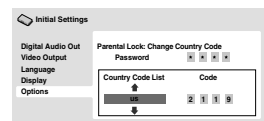
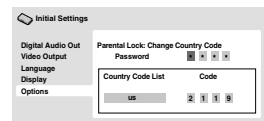
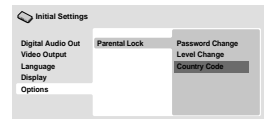

- When you selected "Country Code List": Press **▲** or **▼** to select Country Code, then press **ENTER**.
- When you selected "Code": Press **▶** then use the **Number buttons (0-9)** to enter the 4-digit Country Code then press **ENTER**. (see Country/Area Code List on page 37)

NOTE

- Depending on the discs, the unit cannot limit playback.
- Some discs may not be encoded with specific rating level information though its disc jacket says "adult." For those discs, the age restriction will not work.
- If you input a wrong number, press **◀**, then input correct number.

NOTE

If you forget the password...

1. Press **EJECT** to remove the disc.
2. While holding **STOP** down on the front panel, press **7** on the remote control for more than 2 seconds.
3. Enter a new password again.

Appendix

Language Code List

Language (Language code letter), **Language code**

Japanese (ja), 1001	Bhutani (dz), 0426	Kirghiz (ky), 1125	Sinhalese (si), 1909
English (en), 0514	Esperanto (eo), 0515	Latin (la), 1201	Slovak (sk), 1911
French (fr), 0618	Estonian (et), 0520	Lingala (ln), 1214	Slovenian (sl), 1912
German (de), 0405	Basque (eu), 0521	Laothian (lo), 1215	Samoan (sm), 1913
Italian (it), 0920	Persian (fa), 0601	Lithuanian (lt), 1220	Shona (sn), 1914
Spanish (es), 0519	Finnish (fi), 0609	Latvian (lv), 1222	Somali (so), 1915
Chinese (zh), 2608	Fiji (fj), 0610	Malagasy (mg), 1307	Albanian (sq), 1917
Dutch (nl), 1412	Faroese (fo), 0615	Maori (mi), 1309	Serbian (sr), 1918
Portuguese (pt), 1620	Frisian (fy), 0625	Macedonian (mk), 1311	Siswati (ss), 1919
Swedish (sv), 1922	Irish (ga), 0701	Malayalam (ml), 1312	Sesotho (st), 1920
Russian (ru), 1821	Scots-Gaelic (gd), 0704	Mongolian (mn), 1314	Sundanese (su), 1921
Korean (ko), 1115	Galician (gl), 0712	Moldavian (mo), 1315	Swahili (sw), 1923
Greek (el), 0512	Guarani (gn), 0714	Marathi (mr), 1318	Tamil (ta), 2001
Afar (aa), 0101	Gujarati (gu), 0721	Malay (ms), 1319	Telugu (te), 2005
Abkhazian (ab), 0102	Hausa (ha), 0801	Maltese (mt), 1320	Tajik (tg), 2007
Afrikaans (af), 0106	Hindi (hi), 0809	Burmese (my), 1325	Thai (th), 2008
Amharic (am), 0113	Croatian (hr), 0818	Nauru (na), 1401	Tigrinya (ti), 2009
Arabic (ar), 0118	Hungarian (hu), 0821	Nepali (ne), 1405	Turkmen (tk), 2011
Assamese (as), 0119	Armenian (hy), 0825	Norwegian (no), 1415	Turkish (tr), 2018
Aymara (ay), 0125	Interlingua (ia), 0901	Occitan (oc), 1503	Tsonga (ts), 2019
Azerbaijani (az), 0126	Interlingue (ie), 0905	Oromo (om), 1513	Tatar (tt), 2020
Bashkir (ba), 0201	Inupiak (ik), 0911	Oriya (or), 1518	Twi (tw), 2023
Byelorussian (be), 0205	Indonesian (in), 0914	Panjabi (pa), 1601	Ukrainian (uk), 2111
Bulgarian (bg), 0207	Icelandic (is), 0919	Polish (pl), 1612	Urdu (ur), 2118
Bihari (bh), 0208	Hebrew (iw), 0923	Pashto, Pushto (ps), 1619	Uzbek (uz), 2126
Bislama (bi), 0209	Yiddish (ji), 1009	Quechua (qu), 1721	Vietnamese (vi), 2209
Bengali (bn), 0214	Javanese (jw), 1023	Rhaeto-Romance (rm), 1813	Volapük (vo), 2215
Tibetan (bo), 0215	Georgian (ka), 1101	Kirundi (rn), 1814	Wolof (wo), 2315
Breton (br), 0218	Kazakh (kk), 1111	Romanian (ro), 1815	Xhosa (xh), 2408
Catalan (ca), 0301	Greenlandic (kl), 1112	Kinyarwanda (rw), 1823	Yoruba (yo), 2515
Corsican (co), 0315	Cambodian (km), 1113	Sanskrit (sa), 1901	Zulu (zu), 2621
Czech (cs), 0319	Kannada (kn), 1114	Sindhi (sd), 1904	
Welsh (cy), 0325	Kashmiri (ks), 1119	Sangho (sg), 1907	
Danish (da), 0401	Kurdish (ku), 1121	Serbo-Croatian (sh), 1908	

Country/Area Code List

Country/Area, Country/Area code, Country/Area code letter

Argentina, 0118, ar	Finland, 0609, fi	Malaysia, 1325, my	Singapore, 1907, sg
Australia, 0121, au	France, 0618, fr	Mexico, 1324, mx	Spain, 0519, es
Austria, 0120, at	Germany, 0405, de	Netherlands, 1412, nl	Sweden, 1905, se
Belgium, 0205, be	Hong Kong, 0811, hk	New Zealand, 1426, nz	Switzerland, 0308, ch
Brazil, 0218, br	India, 0914, in	Norway, 1415, no	Taiwan, 2023, tw
Canada, 0301, ca	Indonesia, 0904, id	Pakistan, 1611, pk	Thailand, 2008, th
Chile, 0312, cl	Italy, 0920, it	Philippines, 1608, ph	United Kingdom, 0702, gb
China, 0314, cn	Japan, 1016, jp	Portugal, 1620, pt	USA, 2119, us
Denmark, 0411, dk	Republic of Korea, 1118, kr	Russian Federation, 1821, ru	

Appendix

Troubleshooting

Problem	Possible Solution
<ul style="list-style-type: none"> No power 	<ul style="list-style-type: none"> Check if you pressed POWER on the TV/DVD, or on the remote control unit. (See page 20.) Is the AC cord disconnected? (See page 9.) Has the power been turned on? (See page 20.)
<ul style="list-style-type: none"> Unit cannot be operated. 	<ul style="list-style-type: none"> External influences such as lightning, static electricity, may cause improper operation. In this case, operate the unit after first turning off the power of the TV/ DVD or unplugging the AC cord and replugging it in after 1 or 2 minutes.
<ul style="list-style-type: none"> Remote control unit does not operate. 	<ul style="list-style-type: none"> Are batteries inserted with polarity (+, -) aligned? (See page 10.) Are batteries worn out? (Replace with new batteries.) Are you using it under strong or fluorescent lighting? Is a fluorescent light illuminated near the remote control sensor?
<ul style="list-style-type: none"> Picture is cut off/with sidebar screen. 	<ul style="list-style-type: none"> Are screen mode adjustments such as view mode choose made correctly? (See page 22.)
<ul style="list-style-type: none"> Strange color, light color, or color misalignment 	<ul style="list-style-type: none"> Adjust the picture tone. (See page 28.) Is the room too bright? The picture may look dark in a room that is too bright.
<ul style="list-style-type: none"> Power is suddenly turned off. 	<ul style="list-style-type: none"> Is the sleep timer set? (See page 13.) Check the Auto Shut Off settings. (See page 28.) The unit's internal temperature has increased. Remove any objects blocking vent or clean.
<ul style="list-style-type: none"> No picture 	<ul style="list-style-type: none"> Is connection to other components correct? (See page 15.) Is correct input signal source selected after connection? (See page 15.) Is the correct input selected? (See page 15.) Is picture adjustment correct? (See page 28.)
<ul style="list-style-type: none"> No sound 	<ul style="list-style-type: none"> Is the volume too low? (See page 13.) Have you pressed MUTE on the remote control unit? (See page 13.) Is connection to other components correct? (See pages 15-19.) Check the audio output of the connected external equipment. Is the volume too low or mufed? When external equipment is connected via an HDMI cable, you may need to configure the audio to be output through the HDMI cable.
<ul style="list-style-type: none"> The TV sometimes makes a cracking sound. 	<ul style="list-style-type: none"> This is not a malfunction. This happens when the cabinet slightly expands and contracts according to change in temperature. This does not affect the TV's performance.

Troubleshooting-Error Message

The example of an error message displayed on a screen	Possible Solution
<ul style="list-style-type: none"> Digital channel signal strength is low 	<ul style="list-style-type: none"> Check the antenna cable. Check that the antenna is correctly setup.
<ul style="list-style-type: none"> Digital channel is scrambled 	<ul style="list-style-type: none"> It is subscription channel. Contact the service provider.
<ul style="list-style-type: none"> Audio only 	<ul style="list-style-type: none"> The channel has audio contents only.

Troubleshooting-PC mode

Problem	Possible Solution
<ul style="list-style-type: none"> There is no image. 	<ul style="list-style-type: none"> Make sure the RGB cable is properly connected. (See page 19.) Make sure the output signal of the PC and the input signal setting of the TV/DVD set are matched. (See page 19.) Some software prohibit video playback on an external display when playing back a video with a notebook PC. This is not attributable to a problem with the TV/DVD set.
<ul style="list-style-type: none"> There is no sound. 	<ul style="list-style-type: none"> Make sure the PC audio cable is properly connected. (See page 19.) Check if the mute function activates, or if the volume is set to minimum. (See page 13.)
<ul style="list-style-type: none"> The text is blurred. 	<ul style="list-style-type: none"> Adjust "Clock" and "Phase" using the PC Setting menu. (See page 28.)
<ul style="list-style-type: none"> The image is not displayed in the center of the screen. 	<ul style="list-style-type: none"> Adjust "Hor Position" and "Ver Position" using the PC Setting menu. (See page 28.)

Troubleshooting-DVD

Problem	Possible Solution
<ul style="list-style-type: none"> Playback doesn't start. 	<ul style="list-style-type: none"> No disc is inserted. (See page 29.) The disc may be dirty. Clean up the disc. (See page 7.) The TV/DVD cannot play CD-ROMs, etc. (See page 6.)
<ul style="list-style-type: none"> No picture. 	<ul style="list-style-type: none"> TV/DVD selector is not set correctly. (See page 29.)
<ul style="list-style-type: none"> No sound. 	<ul style="list-style-type: none"> Check the input selector of the amplifier is set properly. The TV/DVD is in the special playback mode. (See page 30.) Select the correct Audio Output position on AV amplifier.
<ul style="list-style-type: none"> Picture is distorted during fast reverse/forward playback. 	<ul style="list-style-type: none"> The picture will be distorted occasionally.
<ul style="list-style-type: none"> Stopping playback, search, slowmotion play, repeat play, or program play, etc. cannot be performed. 	<ul style="list-style-type: none"> Some discs may not do some of the functions.
<ul style="list-style-type: none"> No surround sound. 	<ul style="list-style-type: none"> The setup does not match your stereo system.
<ul style="list-style-type: none"> The TV/DVD or remote operation key is not functioning. 	<ul style="list-style-type: none"> Turn off the TV/DVD and unplug the AC power cord for several minutes, then replug it.
<ul style="list-style-type: none"> Playback does not start when the title is selected. 	<ul style="list-style-type: none"> Check the Parental setup. (See page 36.)
<ul style="list-style-type: none"> Audio soundtrack and/or subtitle language is not changed when you playback a DVD. 	<ul style="list-style-type: none"> Multilingual language is not recorded on the DVD disc. (See page 31.)
<ul style="list-style-type: none"> No subtitle. 	<ul style="list-style-type: none"> Some discs have no subtitles. (See page 31.) Subtitles are cleared. Press SUBTITLE. (See page 31.)
<ul style="list-style-type: none"> Angle cannot be changed. 	<ul style="list-style-type: none"> Multi-angles are not recorded on the DVD disc. (See page 31.)
<ul style="list-style-type: none"> "This operation can't be performed" appears on the screen. 	<ul style="list-style-type: none"> The function is prohibited with the TV/DVD or the disc. (See page 29.)

Cautions regarding use in high and low temperature environments

- When the unit is used in a low temperature space (e.g. room, office), the picture may leave trails or appear slightly delayed. This is not a malfunction, and the unit will recover when the temperature returns to normal.
- Do not leave the unit in a hot or cold location. Also, do not leave the unit in a location exposed to direct sunlight or near a heater, as this may cause the cabinet to deform and the Liquid Crystal panel to malfunction.
Storage temperature: -4°F to +140°F (-20°C to +60°C)

CLEARING THE PASSWORD

If you forget the password, clear the password using the following procedure.

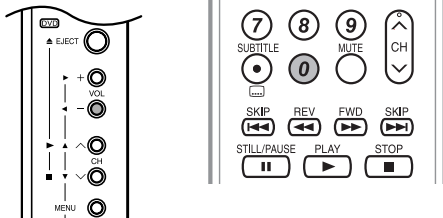

- Press and hold both **VOL -** on the TV/DVD and press **0** on the remote control simultaneously for a few seconds until MENU screen appears on the screen.
- Now the old password was cleared. You can set the new password.

The password is

--	--	--	--	--

NOTE

- As a precautionary measure, make a note of your password above, cut it from this manual, and keep it in a safe place.

Specifications

Item		Model: LC-19DV28UT	Model: LC-22DV28UT	
LCD panel	Size	19" Class (18 1/2" Diagonal)	22" Class (21 1/2" Diagonal)	
	Resolution	1,049,088 pixels (1366 x 768)		
TV Function	TV-standard (CCIR)	American TV Standard ATSC/NTSC System		
	Receiving Channel	VHF/UHF	VHF 2-13ch, UHF 14-69ch	
		CATV	1-135ch (non-scrambled channel only.)	
		Digital Terrestrial Broadcast (8VSB)	2-69ch	
		Digital Cable ^{*1} (64/256 QAM)	1-135ch (non-scrambled channel only.)	
Audio multiplex	BTSC System			
Audio out	1.5W x 2			
Terminals	Side	INPUT 1	AV in, S-VIDEO in	
		INPUT 2	COMPONENT in, Audio in	
		INPUT 3	HDMI in with HDCP	
		INPUT 4	15-pin mini D-sub female connector, Audio in (φ 3.5 mm stereo minijack)	
		DIGITAL AUDIO OUTPUT	Coaxial Digital audio output x 1 (PCM/Dolby Digital)	
		ANT./CABLE	75 Ω Unbalance, F Type x 1 for Analog (VHF/UHF/CATV) and Digital (AIR/CABLE)	
		HEADPHONE	Mini-jack for stereo (φ 3.5 mm)	
OSD language	English/French/Spanish			
Power Requirement	AC 120 V, 60 Hz			
Power Consumption	38 W (0.8 W Standby with AC 120V)		39 W (0.8 W Standby with AC 120V)	
Weight	TV + stand	10.3 lbs./4.7 kg	12.1 lbs./5.5 kg	
	TV only	9.0 lbs./4.1 kg	10.8 lbs./4.9 kg	
Dimension ^{*2} (W x H x D)	TV + stand	18 ^{19/32} x 14 ^{7/32} x 7 ^{59/64} inch	21 ^{1/8} x 15 ^{19/32} x 7 ^{59/64} inch	
	TV only	18 ^{19/32} x 13 ^{5/64} x 2 ^{41/64} inch	21 ^{1/8} x 14 ^{15/32} x 2 ^{41/64} inch	
DVD section	Signal system	NTSC		
	Applicable disc	DVD (12 cm, 8 cm), CD (12 cm, 8 cm)		
	Frequency response	DVD : 4 Hz - 44K Hz / CD : 4 Hz - 20K Hz		
	Wow and flutter	Below Measurable Level		
	Pickup	CD : Wavelength: 780 - 790 nm Maximum output power: 7 mW DVD : Wavelength: 652 - 662 nm Maximum output power: 5 mW		
Operating temperature	+41°F to +104°F (+5°C to +40°C)			

^{*1} Emergency alert messages via Cable are unreceivable.

^{*2} The dimensional drawings are shown on the inside back cover.

- Typical time for power output decrease of about one-half assuming continuous use in a room with normal lighting, normal brightness and temperature at 77°F/25°C.
- As part of policy of continuous improvement, SHARP reserves the right to make design and specification changes for product improvement without prior notice. The performance specification figures indicated are nominal values of production units. There may be some deviations from these values in individual units.

Calling for Service

For location of the nearest Sharp Authorized Service, or to obtain product literature, accessories, supplies, or customer assistance, please call 1-800-BE-SHARP.

LIMITED WARRANTY

CONSUMER LIMITED WARRANTY

SHARP ELECTRONICS CORPORATION warrants to the first consumer purchaser that this Sharp brand Liquid Crystal Display product (the "Product"), when shipped in its original container, will be free from defective workmanship and materials, and agrees that it will, at its option, either repair the defect or replace the defective Product or part thereof with a new or remanufactured equivalent at no charge to the purchaser for parts or labor for the period(s) set forth below.

This warranty does not apply to any appearance items of the Product or if the serial number or model number affixed to the Product has been removed, defaced, changed, altered or tampered with. This warranty does not cover installation or signal reception problems. This limited warranty will not apply if the Product has been or is being used in a commercial setting or application; this warranty is meant solely for the non-commercial, household use of the Product by consumers in their home or residence. If you intend to or already use this Product for commercial purposes or in a commercial setting, there are warranties available to cover your use of this Product, the terms of which may vary. Please contact **1-888-GO-SHARP** for further information.

In order to enforce your rights under this limited warranty, you should follow the steps set forth below. You must be able to provide proof of purchase to the servicer, which proof must include the date of purchase.

To the extent permitted by applicable state law, the warranties set forth are in lieu of, and exclusive of, all other warranties, express or implied. Specifically ALL OTHER WARRANTIES OTHER THAN THOSE SET FORTH ABOVE ARE EXCLUDED, ALL EXPRESS AND IMPLIED WARRANTIES INCLUDING THE WARRANTIES OF MERCHANTABILITY, FITNESS FOR USE, AND FITNESS FOR A PARTICULAR PURPOSE ARE SPECIFICALLY EXCLUDED. IF, UNDER APPLICABLE STATE LAW, IMPLIED WARRANTIES MAY NOT VALIDLY BE DISCLAIMED OR EXCLUDED, THE DURATION OF SUCH IMPLIED WARRANTIES IS LIMITED TO THE PERIOD(S) FROM THE DATE OF PURCHASE SET FORTH BELOW. THIS WARRANTY GIVES YOU SPECIFIC LEGAL RIGHTS. YOU MAY ALSO HAVE OTHER RIGHTS WHICH VARY FROM STATE TO STATE.

The warranties given herein shall be the sole and exclusive warranties granted by Sharp and shall be the sole and exclusive remedy available to the purchaser and only for the time periods set forth herein. No other representations or promises made by anyone are permitted. Correction of defects, in the manner and for the period of time described herein, shall constitute complete fulfillment of all liabilities and responsibilities of Sharp to the purchaser with respect to the Product, and shall constitute full satisfaction of all claims, whether based on contract, negligence, strict liability or otherwise. Sharp does not warrant nor shall Sharp be liable, or in any way responsible, for Products which have been subject to abuse (including, but not limited to, improper voltage), accident, misuse, negligence, lack of reasonable care, alteration, modification, tampering, misuse, improper operation or maintenance or any damages or defects in the Product which were caused by repairs or attempted repairs performed by anyone other than a Sharp authorized servicer. Nor shall Sharp be liable or in any way responsible for any incidental or consequential economic or property damage. Some states do not allow limits on warranties or on remedies for breach in certain transactions; in such states, the limits herein may not apply.

THIS LIMITED WARRANTY IS VALID ONLY IN THE FIFTY (50) UNITED STATES, THE DISTRICT OF COLUMBIA AND PUERTO RICO.

Model Specific Section

Your Product Model Number & Description:

LC-19DV28UT/LC-22DV28UT Combination Liquid Crystal Television And DVD/CD player (Be sure to have this information available when you need service for your Product.)

Warranty Period for this Product:

One (1) year parts and labor from the date of purchase.

Additional Exclusions from Warranty Coverage (if any):

In order for the Product to be serviced, the Product must be readily available to the servicer, free and clear of any complex or non-standard installation, mounting or other encumbrance which would unreasonably interfere with servicing the Product. The Servicer will remount the Product after service, provided that such remounting is not into a complex or non-standard installation. Any additional labor and materials required to remove and/or reinstall a Product above and beyond the foregoing are not covered by this warranty, may result in additional charges and are the responsibility of the consumer. Image Retention resulting from a fixed image being displayed for long periods of time is not covered by this Limited Warranty (see Operation Manual on how to prevent this).

Where to Obtain Service:

From a Sharp Authorized Servicer located in the United States. To find the location of the nearest Sharp Authorized Servicer, please call Sharp toll free at 1-800-BE-SHARP.

What to do to Obtain Service:

Ship prepaid or carry in your Product to a Sharp Authorized Servicer. Be sure to have proof of purchase available. If you ship the Product, be sure it is insured and packaged securely. Please use two persons to carry the Product, transport it in its original packaging, and ensure that the Product is covered to avoid scratches and damage. Sharp shall not be responsible for lost, stolen or misdirected mail or for damage to the product incurred during shipping.

TO OBTAIN PRODUCT INFORMATION OR PURCHASE ACCESSORIES AND EXTENDED WARRANTIES, CALL **1-800-BE-SHARP** OR VISIT www.sharppusa.com