

# SHARP®

## LC-22DV17U

COMBINATION LIQUID CRYSTAL TELEVISION  
AND DVD/CD PLAYER  
COMBINÉ TÉLÉVISEUR ACL ET LECTEUR DVD/CD  
COMBINACION TELEVISOR CON PANTALLA DE  
CRISTAL LÍQUIDO CON DVD/DISCOS COMPACTOS

OPERATION MANUAL  
MODE D'EMPLOI  
MANUAL DE OPERACIÓN

ENGLISH

FRANÇAIS

ESPAÑOL



IMPORTANT : Please read this operation manual before starting operating the equipment.  
IMPORTANT : Veuillez lire ce mode d'emploi avant de commencer à utiliser l'appareil.  
IMPORTANTE : Lea este manual de operación antes de comenzar a operar el equipo.



# LC-22DV17U

## COMBINATION LIQUID CRYSTAL TELEVISION AND DVD/CD PLAYER

ENGLISH

### OPERATION MANUAL

**IMPORTANT:**

- To aid reporting in case of loss or theft, please record the TV/DVD's model and serial numbers in the space provided. The numbers are located at the rear of the TV/DVD.

Model No.:

Serial No.:

**Location of the required Marking**

The rating sheet and the safety caution are on the rear of the unit.

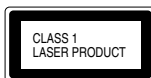

CERTIFICATION: COMPLIES WITH FDA RADIATION PERFORMANCE STANDARDS, 21 CFR SUBCHAPTER J.  
COMPLIES WITH FDA PERFORMANCE STANDARDS FOR LASER PRODUCTS EXCEPT FOR DEVIATIONS PURSUANT TO LASER NOTICE NO. 50, DATED JUNE 24, 2007.

## IMPORTANT INFORMATION

**WARNING:** TO REDUCE THE RISK OF FIRE OR ELECTRIC SHOCK, DO NOT EXPOSE THIS PRODUCT TO RAIN OR MOISTURE.



**CAUTION**

RISK OF ELECTRIC SHOCK  
DO NOT OPEN



CAUTION: TO REDUCE THE RISK OF ELECTRIC SHOCK,  
DO NOT REMOVE COVER (OR BACK).  
NO USER-SERVICEABLE PARTS INSIDE.  
REFER SERVICING TO QUALIFIED SERVICE  
PERSONNEL.



The lightning flash with arrow-head symbol, within an equilateral triangle, is intended to alert the user to the presence of uninsulated "dangerous voltage" within the product's enclosure that may be of sufficient magnitude to constitute a risk of electric shock to persons.



The exclamation point within a triangle is intended to alert the user to the presence of important operating and maintenance (servicing) instructions in the literature accompanying the product.

# IMPORTANT INFORMATION

**CAUTION:** TO PREVENT ELECTRIC SHOCK, MATCH WIDE BLADE OF PLUG TO WIDE SLOT, FULLY INSERT.

**WARNING:** FCC Regulations state that any unauthorized changes or modifications to this equipment not expressly approved by the manufacturer could void the user's authority to operate this equipment.

**CAUTION:**

This product satisfies FCC regulations when shielded cables and connectors are used to connect the unit to other equipment. To prevent electromagnetic interference with electric appliances such as radios and televisions, use shielded cables and connectors for connections.

"Note to CATV system installer: This reminder is provided to call the CATV system installer's attention to Article 820-40 of the National Electrical Code that provides guidelines for proper grounding and, in particular, specifies that the cable ground shall be connected to the grounding system of the building, as close to the point of cable entry as practical."

This product utilizes tin-lead solder, and fluorescent lamp containing a small amount of mercury. Disposal of these materials may be regulated due to environmental considerations. For disposal or recycling information, please contact your local authorities, the Electronic Industries Alliance: [www.eiae.org](http://www.eiae.org), the lamp recycling organization: [www.lamprecycle.org](http://www.lamprecycle.org) or Sharp at 1-800-BE-SHARP (For U.S.A. Only)

**CAUTION:**

THIS DIGITAL VIDEO PLAYER EMPLOYS A LASER SYSTEM.

TO ENSURE PROPER USE OF THIS PRODUCT, PLEASE READ THIS USER'S GUIDE CAREFULLY AND RETAIN FOR FUTURE REFERENCE. SHOULD THE UNIT REQUIRE MAINTENANCE, CONTACT AN AUTHORIZED SERVICE LOCATION SEE SERVICE PROCEDURE.

USE OF CONTROLS, ADJUSTMENTS OR THE PERFORMANCE OF PROCEDURES OTHER THAN THOSE SPECIFIED HEREIN MAY RESULT IN HAZARDOUS RADIATION EXPOSURE.

TO PREVENT DIRECT EXPOSURE TO LASER BEAM, DO NOT TRY TO OPEN THE ENCLOSURE. VISIBLE LASER RADIATION MAY BE PRESENT WHEN THE ENCLOSURE IS OPENED. DO NOT STARE INTO BEAM.

**DECLARATION OF CONFORMITY**

SHARP COMBINATION LIQUID CRYSTAL TELEVISION AND DVD CD PLAYER, MODEL LC-22DV17U.

This device complies with Part 15 of the FCC Rules. Operation is subject to the following two conditions:

(1) This device may not cause harmful interference, and (2) this device must accept any interference received, including interference that may cause undesired operation.

RESPONSIBLE PARTY:

SHARP ELECTRONICS CORPORATION

Sharp Plaza, Mahwah, New Jersey 07495-1163

TEL: 1-800-BE-SHARP

For Business Customers: URL <http://www.sharpusa.com>

**INFORMATION:**

This equipment has been tested and found to comply with the limits for a Class B digital device, pursuant to Part 15 of the FCC Rules. These limits are designed to provide reasonable protection against harmful interference in a residential installation. This equipment generates, uses and can radiate radio frequency energy and, if not installed and used in accordance with the instructions, may cause harmful interference to radio communications. However, there is no guarantee that interference will not occur in a particular installation. If this equipment does cause harmful interference to radio or television reception, which can be determined by turning the equipment off and on, the user is encouraged to try to correct the interference by one or more of the following measures:

- Reorient or relocate the receiving antenna.
- Increase the separation between the equipment and receiver.
- Connect the equipment into an outlet on a circuit different from that to which the receiver is connected.
- Consult the dealer or an experienced radio/TV technician for help.

# DEAR SHARP CUSTOMER

Thank you for your purchase of the Sharp Combination Liquid Crystal Television and DVD/CD player. To ensure safety and many years of trouble-free operation of your product, please read the Important Safety Instructions carefully before using this product.

## IMPORTANT SAFETY INSTRUCTIONS

Electricity is used to perform many useful functions, but it can also cause personal injuries and property damage if improperly handled. This product has been engineered and manufactured with the highest priority on safety. However, improper use can result in electric shock and/or fire. In order to prevent potential danger, please observe the following instructions when installing, operating and cleaning the product. To ensure your safety and prolong the service life of your Liquid Crystal Television, please read the following precautions carefully before using the product.

- 1) Read these instructions.
- 2) Keep these instructions.
- 3) Heed all warnings.
- 4) Follow all instructions.
- 5) Do not use this apparatus near water.
- 6) Clean only with dry cloth.
- 7) Do not block any ventilation openings. Install in accordance with the manufacturer's instructions.
- 8) Do not install near any heat sources such as radiators, heat registers, stoves, or other apparatus (including amplifiers) that produce heat.
- 9) Do not defeat the safety purpose of the polarized or grounding-type plug. A polarized plug has two blades with one wider than the other. A grounding type plug has two blades and a third grounding prong. The wide blade or the third prong are provided for your safety. If the provided plug does not fit into your outlet, consult an electrician for replacement of the obsolete outlet.
- 10) Protect the power cord from being walked on or pinched particularly at plugs, convenience receptacles, and the point where they exit from the apparatus.
- 11) Only use attachments/accessories specified by the manufacturer.
- 12) Use only with the cart, stand, tripod, bracket, or table specified by the manufacturer, or sold with the apparatus. When a cart is used, use caution when moving the cart/apparatus combination to avoid injury from tip-over.
- 13) Unplug this apparatus during lightning storms or when unused for long periods of time.
- 14) Refer all servicing to qualified service personnel. Servicing is required when the apparatus has been damaged in any way, such as power-supply cord or plug is damaged, liquid has been spilled or objects have fallen into the apparatus, the apparatus has been exposed to rain or moisture, does not operate normally, or has been dropped.



### Additional Safety Information

- 15) Power Sources—This product should be operated only from the type of power source indicated on the marking label. If you are not sure of the type of power supply to your home, consult your product dealer or local power company. For products intended to operate from battery power, or other sources, refer to the operating instructions.
- 16) Overloading—Do not overload wall outlets, extension cords, or integral convenience receptacles as this can result in a risk of fire or electric shock.
- 17) Object and Liquid Entry—Never push objects of any kind into this product through openings as they may touch dangerous voltage points or short-out parts that could result in a fire or electric shock. Never spill liquid of any kind on the product.
- 18) Damage Requiring Service—Unplug this product from the wall outlet and refer servicing to qualified service personnel under the following conditions:
  - a) When the AC cord or plug is damaged,
  - b) If liquid has been spilled, or objects have fallen into the product,
  - c) If the product has been exposed to rain or water,
  - d) If the product does not operate normally by following the operating instructions.  
Adjust only those controls that are covered by the operating instructions as an improper adjustment of other controls may result in damage and will often require extensive work by a qualified technician to restore the product to its normal operation,
  - e) If the product has been dropped or damaged in any way, and
  - f) When the product exhibits a distinct change in performance - this indicates a need for service.
- 19) Replacement Parts—When replacement parts are required, be sure the service technician has used replacement parts specified by the manufacturer or have the same characteristics as the original part. Unauthorized substitutions may result in fire, electric shock, or other hazards.
- 20) Safety Check—Upon completion of any service or repairs to this product, ask the service technician to perform safety checks to determine that the product is in proper operating condition.
- 21) Wall or ceiling mounting—When mounting the product on a wall or ceiling, be sure to install the product according to the method recommended by the manufacturer.

# IMPORTANT SAFETY INSTRUCTIONS

- **Water and Moisture** — Do not use this product near water - for example, near a bath tub, wash bowl, kitchen sink, or laundry tub; in a wet basement; or near a swimming pool; and the like.
- **Stand** — Do not place the product on an unstable cart, stand, tripod or table. Placing the product on an unstable base can cause the product to fall, resulting in serious personal injuries as well as damage to the product. Use only a cart, stand, tripod, bracket or table recommended by the manufacturer or sold with the product. When mounting the product on a wall, be sure to follow the manufacturer's instructions. Use only the mounting hardware recommended by the manufacturer.
- **Selecting the location** — Select a place with no direct sunlight and good ventilation.
- **Ventilation** — The vents and other openings in the cabinet are designed for ventilation. Do not cover or block these vents and openings since insufficient ventilation can cause overheating and/or shorten the life of the product. Do not place the product on a bed, sofa, rug or other similar surface, since they can block ventilation openings. This product is not designed for built-in installation; do not place the product in an enclosed place such as a bookcase or rack, unless proper ventilation is provided or the manufacturer's instructions are followed.
- **The Liquid Crystal panel used in this product is made of glass.** Therefore, it can break when the product is dropped or applied with impact. Be careful not to be injured by broken glass pieces in case the panel breaks.
- **Heat** — The product should be situated away from heat sources such as radiators, heat registers, stoves, or other products (including amplifiers) that produce heat.
- **The Liquid Crystal panel is a very high technology product with 1,049,088 pixels, giving you fine picture details.** Occasionally, a few non-active pixels may appear on the screen as a fixed point of blue, green or red. Please note that this does not affect the performance of your product.
- **Lightning** — For added protection for this television equipment during a lightning storm, or when it is left unattended and unused for long periods of time, unplug it from the wall outlet and disconnect the antenna. This will prevent damage to the equipment due to lightning and power-line surges.
- **Power Lines** — An outside antenna system should not be located in the vicinity of overhead power lines or other electric light or power circuits, or where it can fall into such power lines or circuits. When installing an outside antenna system, extreme care should be taken to keep from touching such power lines or circuits as contact with them might be fatal.
- **Outdoor Antenna Grounding** — If an outside antenna is connected to the television equipment, be sure the antenna system is grounded so as to provide some protection against voltage surges and built-up static charges. Article 810 of the National Electrical Code, ANSI/NFPA 70, provides information with regard to proper grounding of the mast and supporting structure, grounding of the lead-in wire to an antenna discharge unit, size of grounding conductors, location of antenna-discharge unit, connection to grounding electrodes, and requirements for the grounding electrode.

EXAMPLE OF ANTENNA GROUNDING AS PER NATIONAL ELECTRICAL CODE, ANSI/NFPA 70

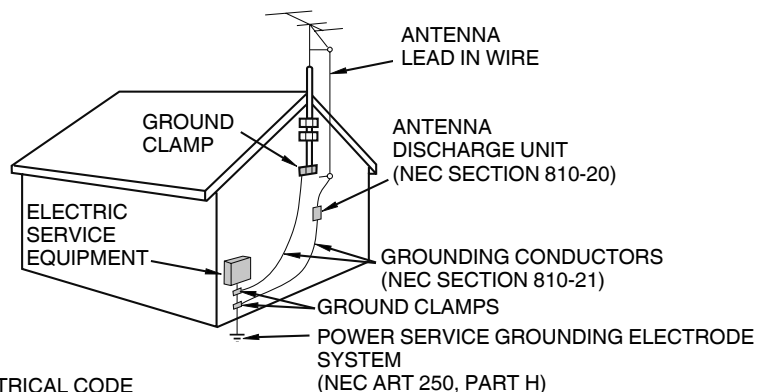

NEC — NATIONAL ELECTRICAL CODE

- To prevent fire, never place any type of candle or flames on the top or near the TV set.
- To prevent fire or shock hazard, do not expose this product to dripping or splashing. No objects filled with liquids, such as vases, should be placed on the product.
- To prevent fire or shock hazard, do not place the AC cord under the TV set or other heavy items.
- Turn off the main power and unplug the AC cord from the wall outlet before handling.
- Use a soft cloth and gently wipe the surface of the display panel. Using a hard cloth may scratch the panel surface.
- Use a soft damp cloth to gently wipe the panel when it is really dirty. (It may scratch the panel surface when wiped strongly.)
- If the panel is dusty, use an anti-static brush, which is commercially available, to clean it.
- To protect the panel, do not use a dirty cloth, liquid cleaners or chemical cloth to clean it, such materials may damage the panel surface.
- Do not display a still picture for a long time, as this could cause an afterimage to remain.
- Install the product on the place where the AC cord can be unplugged easily from the AC outlet, or from the AC INPUT terminal on the rear of the product.
- **CONDENSATION** — Moisture will form in the operating section of the player if the player is brought from cool surroundings into a warm room or if the temperature of the room rises suddenly. When this happens, player's performance will be impaired. To prevent this, let the player stand in its new surroundings for about an hour before switching it on, or make sure that the room temperature rises gradually. Condensation may also form during the summer if the player is exposed to the breeze from an air conditioner. In such cases, change the location of the player.
- **DISC SLOT** — Keep your fingers well clear of the disc slot as it is closing. Failure to do so may cause serious personal injury.
- **LASER BEAM** — Do not look into the opening of the disc slot or ventilation opening of the product to see the source of the laser beam. Doing so may cause sight damage.
- **DISC** — Do not use a cracked, deformed, or repaired disc. These discs are easily broken and may cause serious personal injury and product malfunction.
- When transporting the TV, never carry it by holding or otherwise putting pressure onto the display.
- Do not insert foreign objects into the product. Inserting objects in the air vents or other openings may result in fire or electric shock. Exercise special caution when using the product around children.

# IMPORTANT SAFETY INSTRUCTIONS

## CHILD SAFETY

It Makes A Difference How and Where You Use Your Flat Panel Display

Congratulations on your purchase! As you enjoy your new product, please keep these safety tips in mind:



### THE ISSUE

- The home theater entertainment experience is a growing trend and larger flat panel displays are popular purchases. However, flat panel displays are not always supported on the proper stands or installed according to the manufacturer's recommendations.
- Flat panel displays that are inappropriately situated on dressers, bookcases, shelves, desks, speakers, chests or carts may fall over and cause injury.

### THIS MANUFACTURER CARES!

- The consumer electronics industry is committed to making home entertainment enjoyable and safe.

### TUNE INTO SAFETY

- One size does NOT fit all. Follow the manufacturer's recommendations for the safe installation and use of your flat panel display.
- Carefully read and understand all enclosed instructions for proper use of this product.
- Don't allow children to climb on or play with furniture and television sets.
- Don't place flat panel displays on furniture that can easily be used as steps, such as a chest of drawers.
- Remember that children can become excited while watching a program, especially on a "larger than life" flat panel display. Care should be taken to place or install the display where it cannot be pushed, pulled over, or knocked down.
- Care should be taken to route all cords and cables connected to the flat panel display so that they cannot be pulled or grabbed by curious children.

### WALL MOUNTING: IF YOU DECIDE TO WALL MOUNT YOUR FLAT PANEL DISPLAY, ALWAYS:

- Use a mount that has been recommended by the display manufacturer and/or listed by an independent laboratory (such as UL, CSA, ETL).
- Follow all instructions supplied by the display and wall mount manufacturers.
- If you have any doubts about your ability to safely install your flat panel display, contact your retailer about professional installation.
- Make sure that the wall where you are mounting the display is appropriate. Some wall mounts are not designed to be mounted to walls with steel studs or old cinder block construction. If you are unsure, contact a professional installer.
- A minimum of two people are required for installation. Flat panel displays can be heavy.







**Note:** CEA is the preeminent trade association promoting growth in the \$161 billion U.S. consumer electronics industry. More than 2,200 companies enjoy the benefits of CEA membership, including legislative advocacy, market research, technical training and education, industry promotion and the fostering of business and strategic relationships.

# Disc

## Discs which can be played back

In this unit, use only discs that meet the standard, such as those bearing the below logo marks on the disc label surface. If you use a non-standard disc, we cannot guarantee playback. Even if such a disc can be played back, we cannot guarantee the image or sound quality. The DVD logo is a registered trademark.

Media type	Logo mark
DVD-Video	
DVD-R/RW (Video format only)	
Audio CD*	
CD-R/CD-RW (CD-DA, MP3, WMA or JPEG format)	

- \* This unit is designed to playback music Compact Discs (CD) that conform to the CD standard. CDs that contain (copy-restriction) signals to protect copyrights cannot be played back.
- Some CD-R/RWs and DVD-R/RW can not be played back depending on the recording conditions.
  - 8 cm discs can be played without an adapter.

### Region management information

This unit is designed and manufactured to support the region management information that is recorded on a DVD disc. If the region number written on the DVD disc does not correspond to the region number of this unit, this unit cannot play that disc.

- The region number of this unit is "1".
- The unit will play DVD-Video discs marked with labels containing "1" or "ALL".

Example:



### Operating DVD-Video

- Some operations of DVD-Video may be prohibited by the manufacturer, or some operation methods or functions of the DVD-Video may be different from the description in this manual.
- If you attempt an operation that is prohibited by either the disc or the unit, a "X" mark will appear on the TV screen. For operations prohibited by the disc, see the information that came with the disc.
- When the menu screen or the operation guide appears during disc playback, follow the displayed information.

## Discs which cannot be played back

The discs listed below cannot be played back in general. Even if one of these can be played back, it may not be played back correctly. If a disc is played back by mistake, extensively loud sounds may blow the speakers or may damage the hearing of those in hearing range. Do not playback the discs listed below.

CDG, Photo-CD, CD-ROM, CD-TEXT, CD-EXTRA, SACD, PD, DVD-ROM, SVCD, CVD, VCD, DVD-RAM, DVD+R/RW, DVD audio, HD DVD, Blu-ray, etc.

### The following DVD-Video discs may not be played back on this unit:

- DVD-Video that do not have the region number "1" or "ALL".
- PAL or SECAM DVD-Video.
- Prohibited or business-use DVD-Video.

### CD-R/CD-RWs cannot be played back for the following reasons.

- Compatibility of the disc and this unit.
- Compatibility of the disc and the recorder used.
- Unfinalised discs.

### Never use the following discs or accessories. It may cause serious damage to the TV/DVD.

- Irregular shaped discs such as card shaped, heart shaped
- The ring protector or other disc accessories
- The 8cm disc adapter
- Stickered or papered discs
- Discs with scotch tape, glue or other remains of labels

## Title/Chapter/Track

A DVD-Video has large partitions called "Titles", and smaller partitions within them called "Chapters".

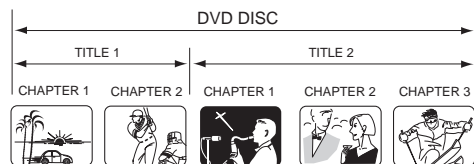

An audio CD has other partitions called "Tracks". A number is allotted to each partition and these numbers are called "title numbers", "chapter numbers" or "track numbers".





## Disc

### Handling discs

#### Removing the Disc from its case

Be sure to hold the edge of disc. Do not touch the surface of the disc.

Pick up the disc gently from the case.

- Do not scratch the disc.
- Do not get dirt on the surface of the disc.
- Do not stick a label or adhesive tape on the disc.
- Do not drop or bend the disc.



#### Storing discs

- Store the disc in the case to avoid any risk of scratches, dirt or damage.
- Do not leave the disc exposed to direct sunlight or in hot or humid places.

#### Cleaning discs

Wipe the disc with a clean, dry cloth from the center outward toward the edges.

- Do not wipe the disc in a circular motion around the center.
- Do not use liquid or aerosol cleaners.

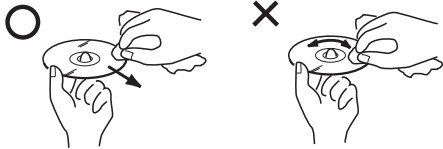

#### Notes on copyright

- This product incorporates copyright protection technology that is protected by U.S. patents and other intellectual property rights. Use of this copyright protection technology must be authorized by Macrovision, and is intended for home and other limited viewing uses only unless otherwise authorized by Macrovision. Reverse engineering or disassembly is prohibited.
- Unauthorized recording of copyrighted television programs, films, video cassettes and other materials may infringe the rights of copyright owners and be contrary to copyright laws.

- Manufactured under license from Dolby Laboratories. "Dolby" and the double-D symbol are trademarks of Dolby Laboratories.
- "HDMI, the HDMI logo and High-Definition Multimedia Interface are trademarks or registered trademarks of HDMI Licensing LLC."
- Manufactured under license under U.S. Patent #: 5,451,942 & other U.S. and worldwide patents issued & pending. DTS and DTS Digital Out are registered trademarks and the DTS logos and Symbol are trademarks of DTS, Inc. © 1996-2008 DTS, Inc. All Rights Reserved
- Products that have earned the ENERGY STAR® are designed to protect the environment through superior energy efficiency.

# Supplied accessories

Make sure the following accessories are provided with the product.

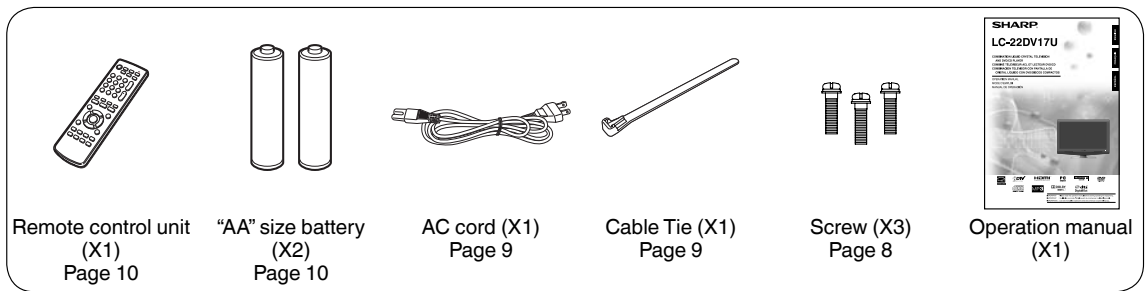

## NOTE

- Always use the AC cord supplied with the TV/DVD.

To avoid scratching the frame or screen, please use a soft, lint free cloth for cleaning. Approved cleaning cloths are available directly from Sharp in single (00Z-LCD-CLOTH) or triple (00Z-LCD-CLOTH- 3) packs. Call 1-800-BE-SHARP for ordering, or VISIT [www.sharpsusa.com/SharpDirect](http://www.sharpsusa.com/SharpDirect).

# QUICK REFERENCE

## Attaching the stand

- Before attaching (or detaching) the stand, unplug the AC cord from the AC input terminal.
- Before performing work spread cushioning over the base area to lay the TV on. This will prevent it from being damaged.

## CAUTION

- **Attach the stand in the correct direction.**
- **Be sure to follow the instructions. Incorrect installation of the stand may result in the TV falling over.**

- 1 Confirm the 3 screws supplied with the TV.

### Screws (X3)

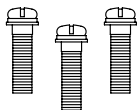

- 2 Remove the covering sheet of the stand.

- ① Insert the stand to the bottom of the TV.
- ② Insert and tighten the 3 screws into the 3 holes on the bottom of the stand.

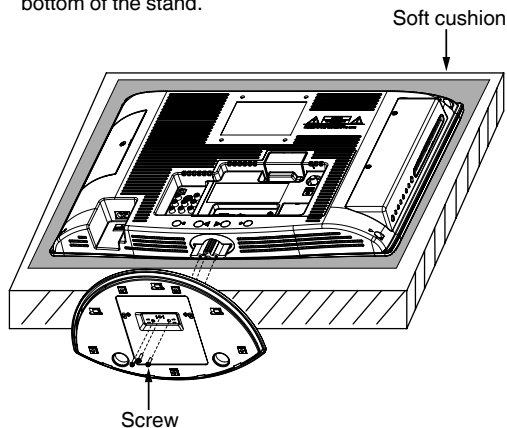

- 3 For protection, sheets are covering the product. Please remove these sheets before use.

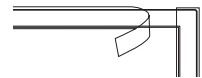

## NOTE

- To detach the stand, perform the step in reverse order.

## Ventilation & Cleaning Tips

Keep your TV/DVD in a well ventilated area and make sure not to place it by a heat source or use near water. The TV/DVD is designed for AC use only and should be used with supplied AC cord.

Clean the screen by spraying a soft lint free cloth with water to lightly moisten. Gently wipe and avoid pressing on the screen. To clean the outer cabinet, use the same method. Do not use liquid or aerosol cleaners.

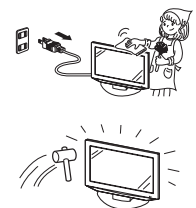

## QUICK REFERENCE

### QUICK INSTALLATION TIPS

- 1 Attach your antenna to the back of the TV/DVD.  
(See page 14.)
- 2 Connect the AC plug for the TV/DVD into the wall outlet.

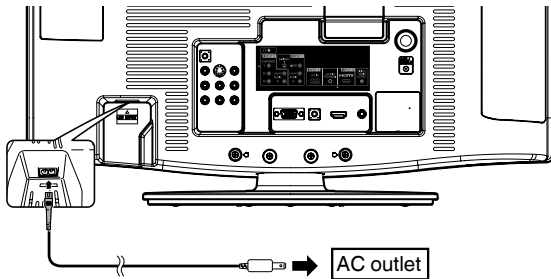

- Place the TV/DVD close to the AC outlet, and keep the power plug within reach.

#### NOTE

- **TO PREVENT RISK OF ELECTRIC SHOCK, DO NOT TOUCH UN-INSULATED PARTS OF ANY CABLES WITH THE AC CORD CONNECTED.**

- 3 Secure cables and cords with the supplied cable tie so that they do not get caught when mounting the cover.

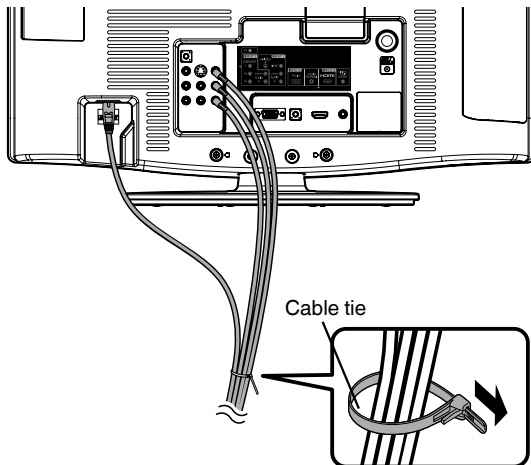

- 4 How to turn on the TV/DVD for the first time.

- A) Press **POWER** on TV/DVD.

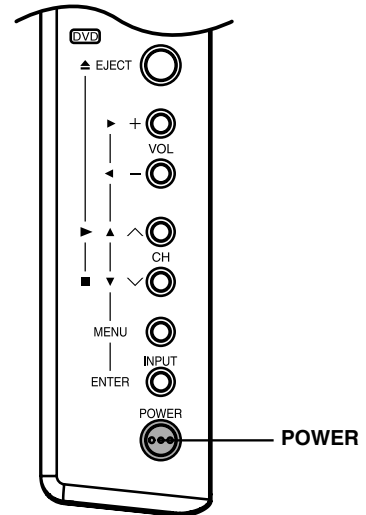

- B) **POWER** indicator on the front of the TV/DVD lights GREEN.

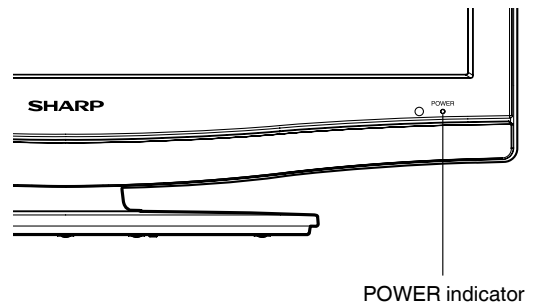

#### NOTE

- Speaker cannot be detached from the TV/DVD.
- TV/DVD angle cannot be adjusted.

## QUICK REFERENCE

If the remote control fails to operate TV/DVD functions, replace the batteries in the remote control unit.

1 Open the battery cover.

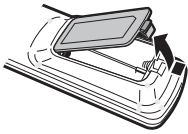

2 Insert two "AA" size batteries (supplied with the product).

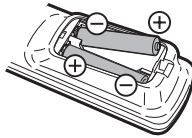

3 Close the battery cover.

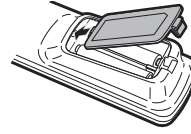

- Place the batteries with their terminals corresponding to the (+) and (-) indications in the battery compartment.

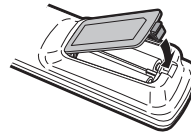

### NOTE

Improper use of batteries can result in chemical leakage or explosion. Be sure to follow the instructions below.

- Do not mix batteries of different types. Different types of batteries have different characteristics.
- Do not mix old and new batteries. Mixing old and new batteries can shorten the life of new batteries or cause chemical leakage in old batteries.
- Remove batteries as soon as they are worn out. Chemicals that leak from batteries that come in contact with skin can cause a rash. If you find any chemical leakage, wipe thoroughly with a cloth.
- The batteries supplied with this product may have a shorter life expectancy due to storage conditions.
- If you will not be using the remote control unit for an extended period of time, remove batteries from it.

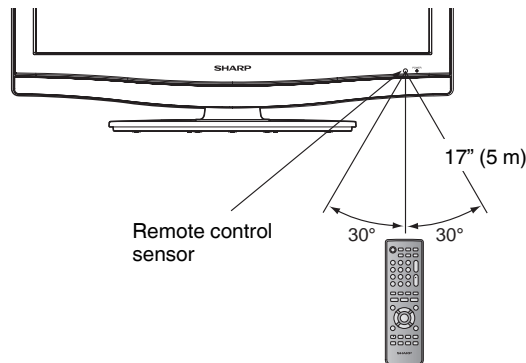

### IMPORTANT:

The POWER indicator on the television should light GREEN indicating you have power to the TV/DVD.

If the POWER indicator on the television still does not light up, press **POWER** on the remote control to turn the power on.

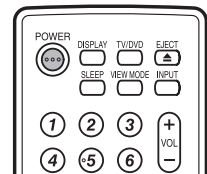

### IMPORTANT:

IF THE UNIT DOES NOT POWER ON - UNPLUG THE TELEVISION FROM THE OUTLET AND REPEAT THE INSTALLATION STEPS.

IF YOU STILL ENCOUNTER NO POWER, PLEASE CONTACT US AT 1-800-BE-SHARP.

# Contents

<b>IMPORTANT INFORMATION</b> .....	1	<b>Watching the DVD</b> .....	26
<b>DEAR SHARP CUSTOMER</b> .....	3	Preparation .....	26
<b>IMPORTANT SAFETY INSTRUCTIONS</b> .....	3	Turning on the power .....	26
<b>Disc</b> .....	6	Select the DVD mode .....	26
Discs which can be played back .....	6	Turning off the power .....	26
Discs which cannot be played back .....	6	Status display of DVD disc.....	26
Title/Chapter/Track.....	6	Special playback .....	27
Handling discs.....	7	Zooming .....	27
<b>Supplied accessories</b> .....	8	Locating desired scene.....	27
<b>QUICK REFERENCE</b> .....	8	Repeat playback.....	27
Attaching the stand .....	8	A-B Repeat playback .....	27
<b>Contents</b> .....	11	Marking desired scenes.....	28
<b>Part names</b> .....	12	Changing angles.....	28
TV/DVD (Front).....	12	Changing soundtrack language .....	28
TV/DVD (Rear) .....	12	Subtitles.....	28
TV/DVD (Left) .....	12	<b>MP3/WMA/JPEG and Audio CD operation</b> .....	29
Remote control unit.....	13	MP3/WMA/JPEG CD information .....	29
<b>Preparation</b> .....	14	Loading CD.....	30
Using the remote control unit .....	14	MP3/WMA and Audio CD playback .....	30
Cautions regarding remote control unit .....	14	Select Files .....	30
Antennas .....	14	JPEG playback.....	30
<b>Using external equipment</b> .....	15	Slide show playback .....	30
Displaying an external equipment image .....	15	Repeat playback (CD) .....	31
Connecting to External Equipment .....	15	Random playback (CD) .....	31
<b>Watching TV</b> .....	16	Program playback (CD) .....	31
Preparation.....	16	<b>Function setup</b> .....	31
Turning on the power.....	16	Basic operation buttons .....	31
Auto Setup.....	16	Quick guide for DVD MENU operation.....	31
Select the TV mode .....	16	Parental control setting .....	33
Turning off the power.....	16	Set the new password .....	33
Changing channels.....	16	Temporary disabling of rating level by DVD disc	33
Auto Ch Memory.....	17	<b>Appendix</b> .....	34
Skipping stored channel .....	17	Language code list .....	34
Clear All.....	17	Troubleshooting.....	35
Display the channel information.....	17	Troubleshooting-Digital broadcasting.....	35
Setting MTS/SAP stereo mode.....	17	Troubleshooting-PC mode.....	35
Selecting the digital audio language .....	18	Troubleshooting-DVD .....	36
View mode for 4:3 programs.....	18	Specifications .....	37
View mode for HD programs.....	18	<b>Calling for Service</b> .....	38
Labeling channels.....	18	<b>LIMITED WARRANTY</b> .....	38
Closed captions and digital closed captions .....	19	<b>Dimensional Drawings</b>	
Caption setup .....	20	• The dimensional drawings for the TV/DVD set are	
Password setting for parental control.....	20	shown on the inside back cover.	
How to enter the Lock menu .....	20		
To clear the all V-Chip settings .....	20		
Parental control (V-CHIP) .....	21		
TV Parental Guidelines (TV Guidelines) .....	21		
Voluntary movie rating system (MPAA) .....	21		
Canadian rating systems .....	22		
Canadian English ratings.....	22		
Canadian French ratings .....	22		
How to temporarily release the V-Chip block .....	22		
<b>Other convenience functions</b> .....	23		
Menu operation buttons.....	23		
Quick guide for MENU operation .....	23		
<b>Connecting a PC (Personal computer)</b> .....	25		
Viewing an image from a PC.....	25		
Displaying an image from a PC.....	25		
PC compatibility chart.....	25		

# Part names

## TV/DVD (Front)

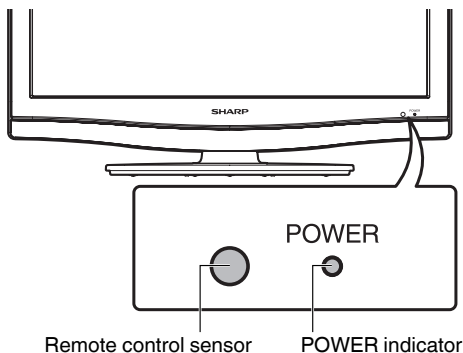

## TV/DVD (Left)

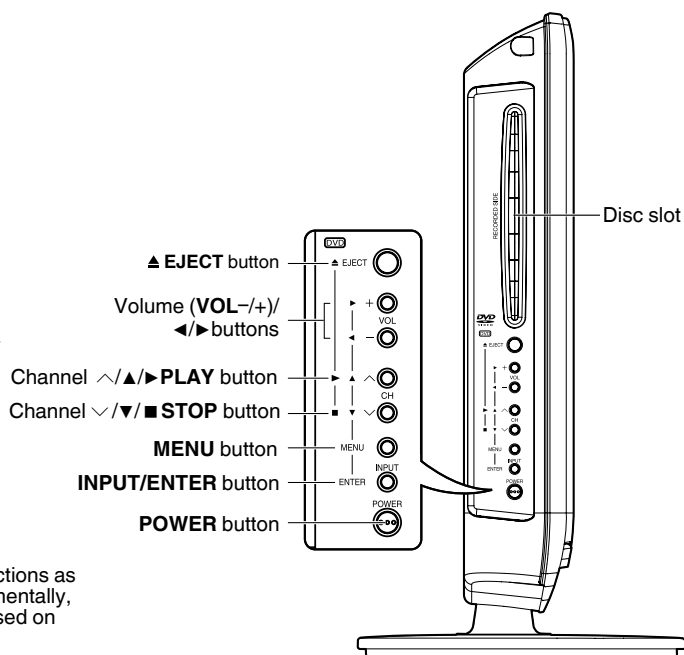

### NOTE

- The buttons on the main unit have the same functions as the same buttons on the remote control. Fundamentally, this operation manual provides a description based on operation using the remote control.

## TV/DVD (Rear)

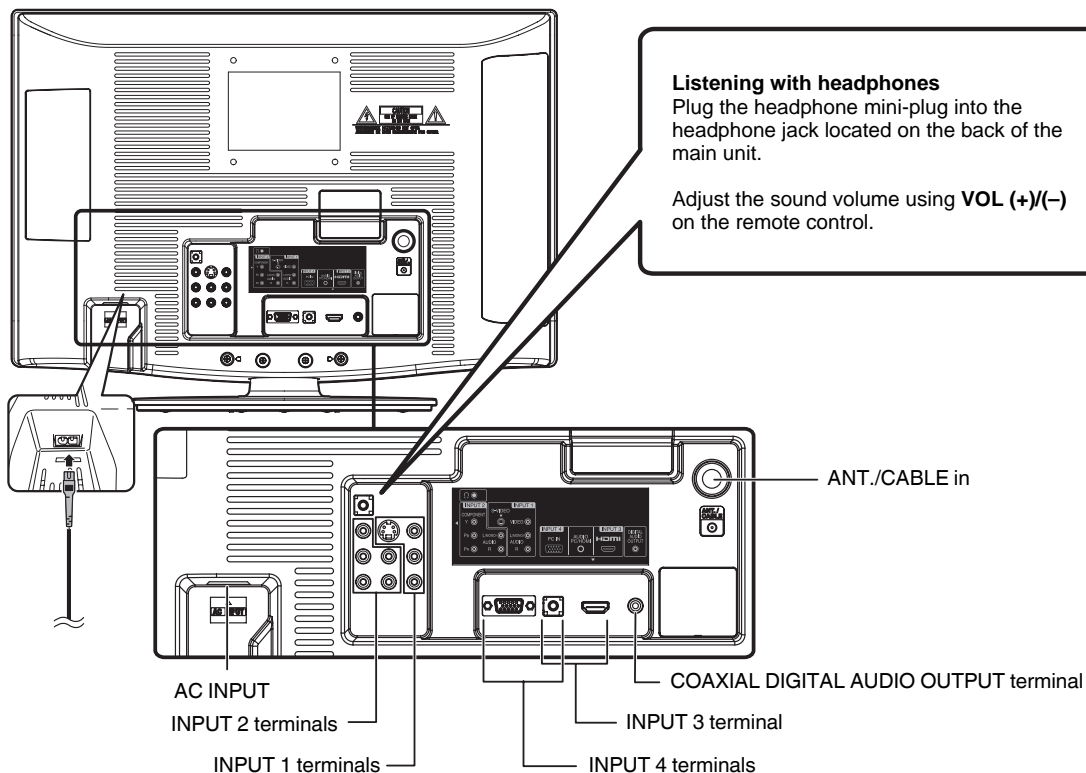

### NOTE

- The illustrations in this operation manual are for explanation purposes and may vary slightly from the actual operations.

## Part names

### Remote control unit

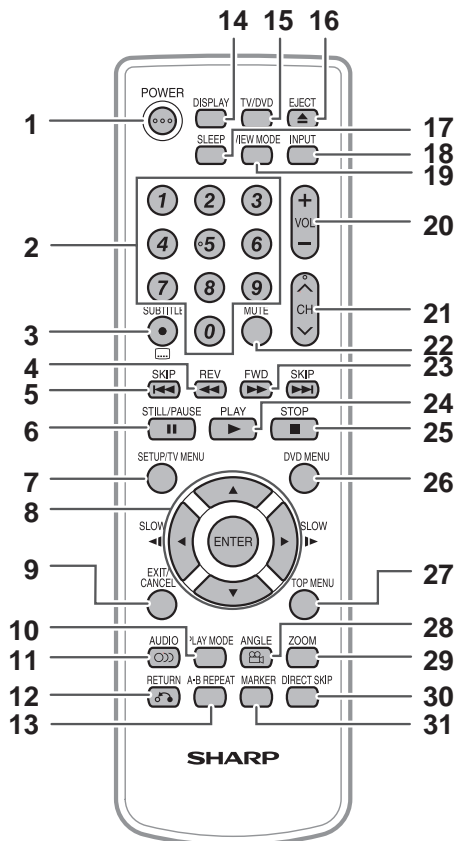

#### NOTE

- When using the remote control unit, point it at the TV/DVD. (See page 10.)

There is a protective film covering the face of the remote control. Please remove this film before use.



- 1 POWER:** Switch the power on or enters standby mode. (See page 16.)
- 2 0-9:** Set the channel. (See page 16.)
- 3 • (DOT) / SUBTITLE:** To select 4-digit channel number. (See page 16.) / Set subtitle. (See page 28.)

- 4 REV :** Review playback. (See page 27.)
- 5 SKIP** : Skip chapter to reverse or forward direction. (See page 27.)
- 6 STILL/PAUSE:** Still picture of DVD / Pause CD sound. (See page 27.)
- 7 SETUP/TV MENU:** TV mode - Display menu of TV / DVD mode - Call up initial setup mode. (See pages 23, 31.)
- 8 ////ENTER:** Select a desired item on the screen.
- SLOW** : Reverse/Forward -slow motion. (See page 27.)
- 9 EXIT/CANCEL:** Turn off the menu screen / Reset information in the menu.
- 10 PLAY MODE:** Select playback mode. (See page 27.)
- 11 AUDIO:** Switch the sound of TV / Change sound track language. (See pages 18, 28.)
- 12 RETURN:** Turn off the DVD setup menu screen.
- 13 A-B REPEAT:** Repeat playback between A and B. (See page 27.)
- 14 DISPLAY:** Display the current channel (or input source) information on the screen. (See page 17.)
- 15 TV/DVD:** Switch between TV/AV and DVD. (See pages 16, 26.)
- 16 EJECT:** Eject the disc. (See page 26.)
- 17 SLEEP:** Allows you to set a time when the TV/DVD automatically switches to standby. Each time you press this button, the remaining time setting switches by 10 minutes up to 2 hours. This display will disappear after a few seconds, and the sleep timer automatically starts counting down.
  - If you want to adjust the sleep timer again, you can press this button repeatedly then change the time setting.
  - Select "Off" by pressing **SLEEP** repeatedly to cancel the sleep timer.
  - The TV/DVD will enter the standby mode when the remaining time reaches zero.
- 18 INPUT:** Select input source. (See page 15.)
- 19 VIEW MODE:** Select the screen size. (See page 18.)
- 20 VOL +/-:** Set the volume.
  - To increase the volume, press **VOL+**.
  - To decrease the volume, press **VOL-**.
  - **VOL+/-** on the TV/DVD operates the same as **VOL+/-** on the remote control unit.
- 21 CH /**: Select the channel. (See page 16.)
- 22 MUTE:** Mute the sound. "Mute" will be displayed on the screen, and the sound is silenced. The muting feature can be released by pressing this button again or one of the VOL +/- buttons.
  - Sound via the COAXIAL DIGITAL AUDIO OUTPUT terminal is not muted.
- 23 FWD:** Fast forward playback. (See page 27.)
- 24 PLAY:** Playback. (See page 26.)
- 25 STOP:** Stop. (See page 26.)
- 26 DVD MENU:** Display DVD menu.
  - Press /// to select desired title.
- 27 TOP MENU:** Display title menu.
  - Press /// to select desired title.
- 28 ANGLE:** Change playback channel. (See page 28.)
- 29 ZOOM:** Zoom. (See page 27.)
- 30 DIRECT SKIP:** Locating desired scene of DVD. (See page 27.)
- 31 MARKER:** Index (DVD). (See page 28.)

# Preparation

## Using the remote control unit

Use the remote control unit by pointing it towards the remote control sensor on the TV/DVD. Objects between the remote control unit and the remote control sensor may prevent proper operation.

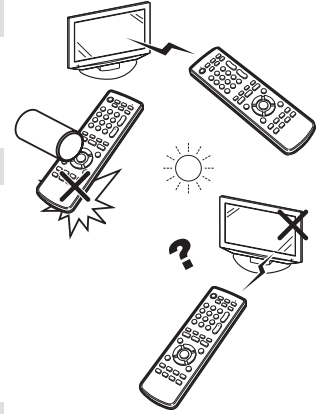

## Cautions regarding remote control unit

- Do not expose the remote control unit to shock. In addition, do not expose the remote control unit to liquids, and do not place in an area with high humidity.
- Do not install or place the remote control unit under direct sunlight. The heat may cause deformation of the remote control unit.
- The remote control unit may not work properly if the remote control sensor on the TV/DVD is under direct sunlight or strong lighting. In such cases, change the angle of the lighting or the TV/DVD, or operate the remote control unit closer to the remote control sensor.

## Antennas

To enjoy a clearer picture, use an outdoor antenna. The following is a brief explanation of the types of connections that are used for a coaxial cable. If your outdoor antenna uses a 75-ohm coaxial cable with an F-type connector, plug it into the antenna terminal at the rear of the TV set.

1. A 75-ohm system is generally a round cable with F-type connector that can easily be attached to a terminal without tools (Commercially available).

F-type connector

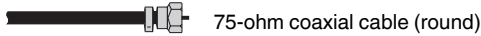

2. A 300-ohm system is a flat "twin-lead" cable that can be attached to a 75-ohm terminal through a 300/75-ohm adapter (Commercially available).

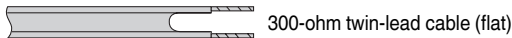

### NOTICE F-type connector should be fingertightened only.

When connecting the RF cable to the TV set, do not tighten F-type connector with tools.

If tools are used, it may cause damage to your TV set. (The breaking of internal circuit, etc.)



F-type connector

75-ohm coaxial cable

## Connecting Antenna Cable

- ① Cable without a CATV converter

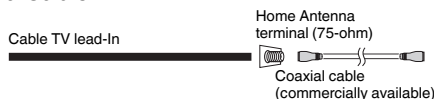

- ② VHF/UHF antenna

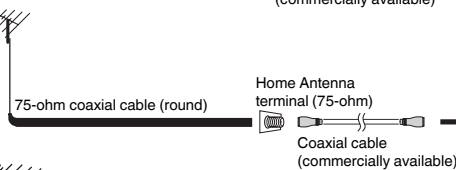

- ③ Combination VHF/UHF antenna

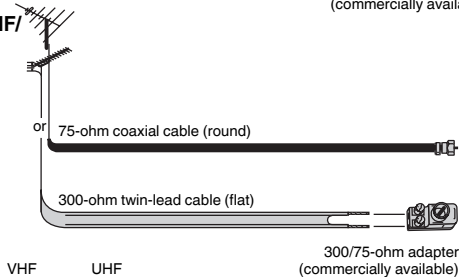

- ④ Separate VHF/UHF antenna

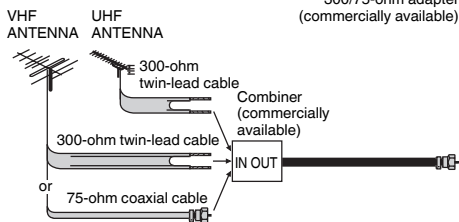

- Connect the antenna cable to the TV using one of the methods in the illustration as shown (①, ②, ③ or ④).

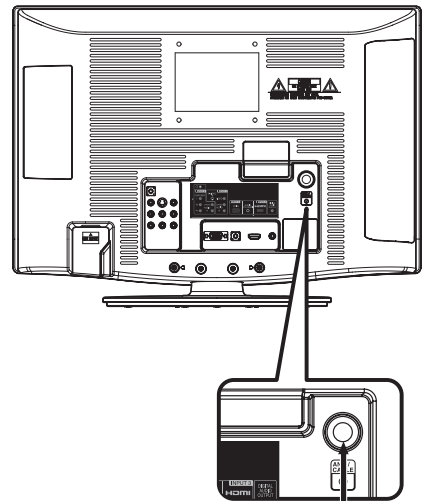

To TV antenna terminal



# Using external equipment

You can connect many types of external equipment to your TV/DVD like a DVD player, VCR, Digital TV tuner, HDMI equipment, game console or camcorder.

## Displaying an external equipment image

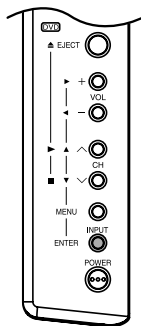
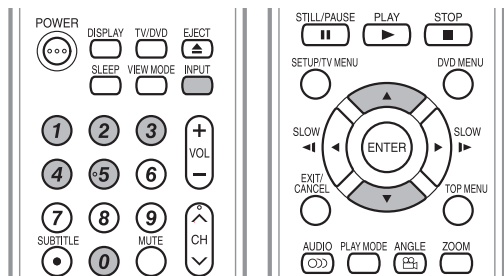

To view external source images, select the input source from “Source Selection” menu using **0-5** on the remote control.

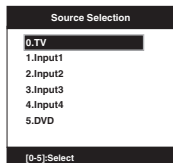

- Each time **INPUT** is pressed, “Source Selection” item toggles.
- You can also select “Source Selection” item by pressing **▲/▼**.

### CAUTION

- To protect equipment, always turn off the TV before connecting a DVD player, VCR, Digital TV tuner, HDMI equipment, game console, camcorder or other external equipment.

### NOTE

- Please read the relevant operation manual (DVD player, etc.) carefully before making connections.
- Refer to your external equipment operation manual for the signal type.

## Connecting to External Equipment

Connecting a DVD player, VCR, Digital TV tuner, HDMI equipment game console or camcorder.

Terminal on the TV/DVD	Cable	Terminal on external equipment
<b>INPUT 1</b> 		
<b>INPUT 2</b> 		
<b>INPUT 1</b> 		
<b>INPUT 3</b> 		
<b>DIGITAL AUDIO OUTPUT</b> 		

### NOTE

- The S-VIDEO terminal takes priority over the video terminals.
- When connecting an HDMI-DVI conversion adapter/cable to the HDMI terminal, the image may not come in clearly.
- When using an HDMI-DVI conversion adapter/cable, use INPUT 3 and AUDIO terminal.

# Watching TV

## Preparation

Perform the following steps before you press **POWER** on the remote control unit.

- 1 Insert the batteries into the remote control unit. (See page 10.)
- 2 Connect the antenna cable to the TV/DVD. (See page 14.)
- 3 Plug in the AC cord to the AC outlet. (See page 9.)

## Turning on the power

Press **POWER** on the TV/DVD, or **POWER** on the remote control.

### TV status indicator (POWER)

ON	Lighting (Green)
OFF/Standby	Lighting (Red)

- **POWER** indicator (Green): The TV/DVD is on. ("Please wait" will appear for a few seconds on the screen.)

## Auto Setup

The Auto Setup menu appears the first time you turn on the TV/DVD, and assists you to select the menu language, specify the Air/Cable setting, and program your channels automatically.

**IMPORTANT:** Make sure that the antenna or cable TV system connection is made!

- 1 The turn on the TV/DVD, press **POWER** (POWER indicator on the front of the unit changes green. It may take approx. 10 seconds for a picture to appear on screen.)
- 2 The "Auto Setup" function begins. Press **◀/▶** to select your desired language.
- 3 Press **▲/▼** to select "Signal Type", then press **◀/▶** to select "Cable" or "Air".

<b>Air</b>	VHF/UHF channels
<b>Cable</b>	CABLE TV channels

- 4 Press **▲/▼** to select "Automatic Search", then press **ENTER**.
- 5 The TV will begin memorizing all the channels available in your area.
  - It may take from 15 minutes to 30 minutes to complete memorizing digital cable channels. Depending on the reception condition, a BAR display may not advance for several minutes, please be patient.

### NOTE

- If you press **EXIT** in the process of "Auto Setup", the Auto Setup stops and changes to the normal screen.
- When you make a menu selection, your changes occur immediately. You do not have to press **EXIT** to see your changes.
- When you are finished programming the menus, press **EXIT**.

## Select the TV mode

Press **TV/DVD** to select the TV mode.

## Turning off the power

Press **POWER** on the TV/DVD, or **POWER** on the remote control.

- The TV enters standby mode and the image on the screen disappears.
- The **POWER** indicator on the TV/DVD changes to Red.

### NOTE

- If you are not going to use this TV/DVD for a long period of time, be sure to remove the AC cord from the power outlet.
- Weak electric power is still consumed even when **POWER** is turned off.

## Changing channels

You can change channels in several ways.

### Method 1

Using **CH** **▲/▼** on the remote control unit or on the TV/DVD.

### NOTE

- If your cable-TV system includes analog and digital channels using the same channel number, your channel up function will scroll through the analog channel first, then the digital channel. Although it may appear as though the channel does not change, it actually moves from the analog to the digital channel in sequence. If you use channel-down, it will move in reverse, from the digital channel to the analog channel.

### Method 2

Using remote control buttons **0-9**, **• (DOT)** to select channels for VHF/UHF/CATV/DIGITAL.

**To select a 1 or 2-digit channel number (e. g., Channel 5):**  
Press **5**

### NOTE

- When selecting a 1-digit channel number, it is not necessary to press **0** before the number.
- When you enter **0-9** only, channel selection will be made if there is no operation within a few seconds.

**To select a 3-digit channel number (e. g., Channel 115):**  
Press **1→1→5**

**To select a 4-digit channel number (e. g., Channel 22.1):**  
Press **2→2→• (DOT) →1**

### NOTE

- When you enter **0-9** only, channel selection will be made if there is no operation within a few seconds.
- If you press **0** by itself in "Air" reception, nothing will happen.
- Complete the above steps within a few seconds.
- When you enter **0-9** and **• (DOT)**, channel selection will be made if there is no operation within a few seconds.

## Watching TV

### Auto Ch Memory

Auto Ch Memory makes the TV/DVD look for all channels viewable in the set area.

- 1 Press **TV MENU** and the MENU screen displays.
- 2 Press **▲/▼** to select "Channel", then press **▶** or **ENTER**. Press **▲/▼** to select "Auto Ch Memory", then press **▶** or **ENTER**.
- 3 Press **▲/▼** to select "Signal Type", then press **◀/▶** to select "Cable" or "Air".
- 4 Press **▲/▼** to select "Automatic Search", then press **ENTER**.
- 5 The TV will begin memorizing all the channels available in your area.
  - It may take from 15 minutes to 30 minutes to complete memorizing digital cable channels. Depending on the reception condition, a BAR display may not advance for several minutes, please be patient.

#### NOTE

- Memorizing channels is best accomplished during evening "PRIMETIME" hours, as more stations are broadcasting digital signals. Memorizing channels can only be accomplished while a station is broadcasting a digital signal to set that channel into memory.
- New digital channels may be added to your area periodically, it is recommended to perform the "Automatic Search" procedure regularly.

### Skipping stored channel

You can set channel selection disabled using **CH ^/∨**.

- 1 Press **TV MENU** and the MENU screen displays.
- 2 Press **▲/▼** to select "Channel", then press **▶** or **ENTER**.
- 3 Press **▲/▼** to select "Add/Delete", then press **▶** or **ENTER**.
- 4 Press **▲/▼** to select "Add/Delete", then press **▶** or **ENTER**.
- 5 Press **▲/▼** to select the channel that you want to skip.
- 6 Press **◀/▶** to select "Delete" for selected channel.
- 7 Press **EXIT** to return to the normal screen.

#### NOTE

- **To add a digital channel you are watching:** Select a channel you want to add. Then select "Adding Channel" in step 4, press **▶** or **ENTER**.
- **To release the skipping channel:** Select "Add" in step 6.

### Clear All

All channels are deleted from the channel memory.

- 1 Press **TV MENU** and the MENU screen displays.
- 2 Press **▲/▼** to select "Channel", then press **▶** or **ENTER**.
- 3 Press **▲/▼** to select "Add/Delete", then press **▶** or **ENTER**.
- 4 Press **▲/▼** to select "Clear All", then press **▶** or **ENTER**.
- 5 Press **EXIT** to return to the normal screen.

### Display the channel information

Press **DISPLAY** to display the current channel (or input source) information on the screen.

When the TV receives a digital signal, the digital information will appear for a few seconds.

- Channel number
- Channel label (if preset)
- V-Chip rating
- Sleep timer
- Program guide
- Resolution
- Station name
- Broadcast program name
- Signal type
- Audio language
- Picture size

When the TV receives an analog signal, the analog information will appear.

- Channel number
- V-Chip rating
- Sleep timer
- Picture size
- Channel label (if preset)
- Signal type
- Audio information (Stereo, SAP or Mono)
- Resolution

### Setting MTS/SAP stereo mode

The TV/DVD has a feature that allows reception of sound other than the main audio for the program. This feature is called Multi-channel Television Sound (MTS). The TV/DVD with MTS can receive mono sound, stereo sound and Secondary Audio Programs (SAP). The SAP feature allows a TV/DVD station to broadcast other information, which could be audio in another language or something completely different like weather information.

**You can enjoy Hi-Fi stereo sound or SAP broadcasts where available.**

#### • Stereo broadcasts

View programs like live sporting events, shows and concerts in dynamic stereo sound.

#### • SAP broadcasts

Receive TV broadcasts in either MAIN or SAP sound.

MAIN sound: The normal program soundtrack (either in mono or stereo).

SAP sound: Listen to a second language, supplementary commentary or other information. (SAP is mono sound.)

**If stereo sound is difficult to hear.**

- Obtain a clearer sound by manually switching to fixed mono-sound mode.

#### NOTE

- MTS only operates while in TV mode.
- MTS is available only when receiving analog broadcasting, not when receiving digital broadcasting.
- When the TV receives a stereo or SAP broadcast, the word "Stereo" or "SAP" displays on-screen if you press **DISPLAY**.

### Changing MTS

You can change MTS as shown below to match the television broadcast signal.

- 1 In analog TV mode, press **AUDIO** and the "Audio" menu screen displays. "MTS" will be highlighted.
- 2 Press **AUDIO** again or **◀/▶** to select "Stereo", "SAP" or "Mono".
- 3 Press **EXIT** to return to the normal screen.

## Selecting the digital audio language

When two or more audio languages are included in a digital signal, you can select one of the audio languages.

- 1 In digital TV mode, press **AUDIO** and the "Audio Language" menu screen displays.
- 2 Press **▲/▼** or **0-6** to select your desired language.
- 3 Press **EXIT** to return to the normal screen.

### NOTE

- Digital audio is active only when receiving digital broadcasting, not when receiving analog broadcasting.

## View mode for 4:3 programs

- 1 Press **VIEW MODE**.
  - The View mode menu displays.
  - The menu lists the view mode options selectable for the type of video signal currently being received.
- 2 Press **0-3** to select each view mode directly while the View mode menu is still on the screen.
  - Each time **VIEW MODE** is pressed, View Mode item toggles.
  - You can also select View Mode item by pressing **▲/▼**.
  - You can sequentially select a view mode that has its own aspect ratio.
  - You can select "Dot by Dot" in PC input mode.

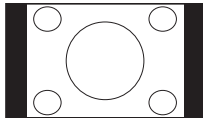

**Side Bar:**  
Suitable for viewing conventional 4:3 programs in their normal format.

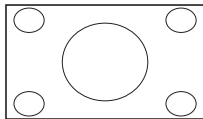

**S.Stretch (Smart stretch):**  
Suitable for stretching 4:3 programs to fill the screen.

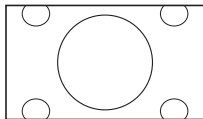

**Zoom:**  
Suitable for viewing wide-screen 2.35:1 anamorphic DVDs in full screen.

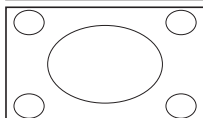

**Stretch:**  
This mode is useful for 1.78:1 DVDs. When viewing 1.85:1 DVDs, stretch mode will still show very thin black bands at the top and bottom of the screen.

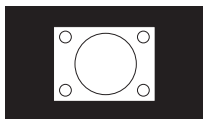

**Dot by Dot (for PC/HDMI mode only):**  
Detects the resolution of the signal of the image and it will be shown on the screen with same amount of pixels.

### NOTE

- You can enter to the same menu screen from "Picture" menu.
- You cannot select "Side Bar" and "S.Stretch" when a 720p, 1080i or 1080p signal is being input.
- Some High Definition and/or Digital broadcasts may not allow you to change the picture size.
- In PC Mode, only the "Side Bar", "Stretch" and "Dot by Dot" picture size features are available. In PC Mode (WXGA), only the "Stretch" and "Dot by Dot" picture size features are available.

## View mode for HD programs

Stretch mode is available for HD programs. Suitable for viewing wide-screen 1.78:1 aspect-ratio programs. When viewing 1.85:1 programs, the stretch mode will still show very thin black bands at the top and bottom of the screen.

## Labeling channels

### To create channel labels

- 1 Select a channel you want to label.
- 2 Press **TV MENU**, then press **▲/▼** to select "Channel", then press **▶** or **ENTER**. Press **▲/▼** to select "Ch Label", then press **▶** or **ENTER**. The Ch Label menu will appear.
- 3 Press **◀/▶** to select a channel you want to label, then press **▼**.

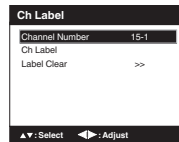

- 4 Press **◀/▶** repeatedly until the character you want appears in the first space.

The characters rotation as follows:

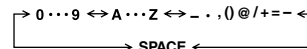

If the character which you desire appears, press **ENTER**. Repeat this step to enter the rest of the characters.

When you finish inputting the label name, press **ENTER**.

- 5 Press **EXIT** to return to the normal screen.
- 6 Repeat steps 1-5 for other channels. You can assign a label to each channel.

### To erase channel labels

- 1 Select a channel with a label which you want to remove.
- 2 Press **TV MENU**, then press **▲/▼** to select "Channel", then press **▶** or **ENTER**. Press **▲/▼** to select "Ch Label", then press **▶** or **ENTER** to display the Ch Label menu.
- 3 Press **▲/▼** to select "Label Clear". Press **▶** or **ENTER**.
- 4 Press **EXIT** to return to the normal screen.
- 5 Repeat steps 1-4 to erase other channel labels.

### Closed captions and digital closed captions

#### NOTE

- Closed Caption might not appear according to the condition of the signal from the broadcasting station.

Your TV/DVD is equipped with an internal Closed Caption decoder. It allows you to view conversations, narration and sound effects as subtitles on your TV/DVD. Closed Captions are available on some TV programs and on some VHS home video tapes at the discretion of the program provider.

Digital Closed Caption service is a new caption service available only on digital TV programs (also at the discretion of the service provider). It is a more flexible system than the original Closed Caption system, because it allows a variety of caption sizes and font styles. When the Digital Closed Caption service is in use, it will be indicated by the appearance of a 3-letter abbreviation that also indicates the language of the Digital Closed Captions: ENG (English), SPA (Spanish), FRA (French) or other language codes.

Not all programs and VHS videotapes offer closed captions. Please look for the “**CC**” symbol to ensure that captions will be shown.

In the Closed Caption system, there can be more than one caption service provided. Each is identified by its own number. The “C1” and “C2” services display subtitles of TV programs superimposed over the program’s picture. Generally, Closed Captions in English are transmitted on C1 and Closed Captions in other languages are transmitted on C2.

In the Closed Caption system, the “Text1” or “Text2” services display text that is unrelated to the program being viewed (e.g., weather or news). These services are also superimposed over the program currently being viewed.

#### NOTE

- If the program or video you selected is not closed-captioned, no captions will display on-screen.
- If text is not available in your viewing area, a black rectangle may appear on-screen. If this happens, setting the “CC Setting” to “Off”.
- When selecting Closed Captions, the captioning will be delayed approx. 10 seconds.
- If no caption signal is received, no captions will appear, but the television will remain in the Caption Mode.
- Misspellings or unusual characters may occasionally appear during Closed Captioning. This is normal with Closed Captioning, especially with live programs. This is because during live programs, captions are also entered live. These transmissions do not allow time for editing.
- When Captions are being displayed, on-screen displays, such as volume and mute may be seen but may interfere with Closed Captions.
- Some Cable TV systems and copy protection systems may interfere with the Closed Captioned signal.
- If using an indoor antenna or if TV reception is very poor, the Closed Caption Decoder may not appear or may appear with strange characters or misspelled words. In this case, adjust the antenna for better reception or use an outdoor antenna.
- When a Digital TV Program has both Digital Closed Caption and Analog Closed Caption signals, Digital Closed Caption is displayed.

- 1 Tune the TV to the desired program.
- 2 Press **TV MENU** and the MENU screen displays.
- 3 Press **▲/▼** to select “Setup”, then press **▶** or **ENTER**.
- 4 Press **▲/▼** to select “Closed Caption”, then press **▶** or **ENTER**.  
The Closed Caption menu will appear.
- 5 Press **◀** or **▶** to setting the “CC Setting” to “On”.
- 6 Press **▲/▼** to select “Analog Caption” or “Digital Caption”.

When you select “Analog Caption”, you can choose C1, C2, C3, C4, T1, T2, T3 and T4.

When you select “Digital Caption”, you can choose from CS1, CS2, CS3, CS4, CS5 and CS6.

- 7 Press **◀/▶** to select the desired Closed Caption mode for both Digital and Analog Caption.
- 8 Press **▲/▼** to select “CC Priority”, then press **◀/▶** to select “Digital CC” or “Analog CC”.
  - Depending on the broadcast signal, some Analog Captions will function with a Digital broadcast signal. This step prevent that two kind of captions are overlapping.
- 9 Press **EXIT** to return to the normal screen.

#### NOTE

- To turn the Closed Caption feature off, setting the “CC Setting” to “Off”.

### Caption setup

This function allows you to adjust the closed caption screen appearance to suit your preference.

- 1 Press **TV MENU** and the MENU screen displays.
- 2 Press **▲/▼** to select "Setup", then press **▶** or **ENTER**.
- 3 Press **▲/▼** to select "Closed Caption", then press **▶** or **ENTER**.  
The Closed Caption menu displays.
- 4 Press **▲/▼** to select "Digital CC Preset", then press **◀/▶** to select "Custom".
- 5 Press **▲/▼** to select "CC Advanced", then press **▶** or **ENTER**.
- 6 Press **▲/▼** to select the desired item, then press **◀/▶** to change the setting.
- 7 Press **EXIT** to return to the normal screen.

Selectable parameters available in each adjustment item.

Item	Selectable parameter
<b>Text Size:</b>	Auto, Small, Standard, Large
<b>Text Type:</b>	Auto, Style1, Style2, Style3, Style4, Style5, Style6, Style7
<b>Text Edge:</b>	Auto, None, Raised, Depressed, Uniform, Left Shadow, Right Shadow
<b>Text Color:</b>	Auto, Black, White, Red, Green, Blue, Yellow, Magenta, Cyan
<b>Text Opacity:</b>	Auto, Solid, Transparent, Translucent, Flashing
<b>Background Color:</b>	Auto, Black, White, Red, Green, Blue, Yellow, Magenta, Cyan
<b>Background Opacity:</b>	Auto, Solid, Transparent, Translucent, Flashing

 **NOTE**

- This feature is designed to customize Digital Captions only.
- The "Auto" value depends on the broadcasting station.

### Password setting for parental control

Allows you to use a password to protect certain settings from being accidentally changed.

**IMPORTANT:**

Three conditions must be met to enable the V-Chip

- ① Password is registered.
- ② V-Chip settings have been made.
- ③ "V-Chip" is set to "On".

**Setting a password**

- 1 Press **TV MENU** and the MENU screen displays.
- 2 Press **▲/▼** to select "Lock", then press **▶** or **ENTER**.
- 3 Select and enter a password (4 digits) using the **number buttons (0-9)**, then press **ENTER**.  
• "\*" appears instead of the number.
- 4 Enter the same password again to confirm, then press **ENTER**, the password is now registered and the Lock menu will appear on the screen.

**Changing the password**

Allows you to change your current password.

- 1 Repeat steps 1 to 3 in **Setting a password**.
- 2 Press **▲/▼** to select "Change Password", then press **▶** or **ENTER**.
- 3 Enter a new password using **0-9**, then press **ENTER**.
- 4 Enter the same password again to confirm, then press **ENTER**.
- 5 The screen returns to Lock menu. Your new password has been set.

 **NOTE**

- **As a precautionary measure, make a note of your password and keep it in a familiar place.**
- The "V-Chip Set (DTV)" will only be selectable when a new rating system can be downloaded via digital broadcasting in the U.S.

### How to enter the Lock menu

- 1 Press **TV MENU** and the MENU screen displays.
- 2 Press **▲/▼** to select "Lock", then press **▶** or **ENTER**.
- 3 Input the 4-digit password by using **0-9**, then press **ENTER**.  
The Lock menu displays.

### To clear the all V-Chip settings

- 1 In the Lock menu, press **▲/▼** to select "V-Chip Clear", then press **▶** or **ENTER**.
- 2 Input the 4-digit password by using **0-9**, then press **ENTER**. All your settings return to the factory settings.

## Watching TV

### Parental control (V-CHIP)

V-CHIP might not function according to the condition of the signal from the broadcasting station.

V-CHIP is an electronic filtering device built into your TV/DVD. This tool gives parents a great degree of control over broadcasts accessed by their children. It allows parents to select programs judged suitable for child viewing while blocking ones judged not suitable. It does so automatically once you activate the V-CHIP feature in your TV/DVD.

**V-CHIP menu will not be selectable from the menu if you do not first configure your password.**  
(See page 20 for password setting for parental control.)

- The U.S. has two rating systems for viewing content: movie ratings and TV Parental Guidelines.
- The TV Parental Guidelines work in conjunction with the V-CHIP to help parents screen out inappropriate television shows from their children.
- Movie ratings are used for original movies rated by the Motion Picture Association of America (MPAA) as watched on cable TV and not edited for television. The V-CHIP can also be set to block MPAA-rated movies.

### TV Parental Guidelines

TV RATING		Content				
		FANTASY VIOLENCE	VIOLENCE	SEXUAL SITUATIONS	ADULT LANGUAGE	SEXUAL DIALOG
Suggested age	TV-Y (All children)	☒	☒	☒	☒	☒
	TV-Y7 (Directed to older children)	X	☒	☒	☒	☒
	TV-G (General audience)		☒	☒	☒	☒
	TV-PG (Parental Guidance suggested)		X	X	X	X
	TV-14 (Parents strongly cautioned)		X	X	X	X
	TV-MA (Mature audience only)		X	X	X	X

☒: The content rating can be set, but this rating is not normally broadcast by TV stations.

X: Content rating can be set.

#### EXAMPLE

- If you select “TV-G”, this will automatically block the higher ratings “TV-PG”, “TV-14” and “TV-MA”.

### Voluntary movie rating system (MPAA)

MOVIE RATING	Description
G	General audiences. All ages admitted.
PG	Parental guidance suggested. Some material may not be suitable for children.
PG-13	Parents strongly cautioned. Some material may be inappropriate for children under 13.
R	Restricted. Under 17 requires accompanying parent or adult guardian (age varies in some jurisdictions).
NC-17	No one 17 and under admitted.
X	X is an older rating that is unified with NC-17 but may be encoded in the data of older movies.

#### EXAMPLE

- If you select “PG-13”, this will automatically block the higher ratings “R”, “NC-17” and “X”.

#### NOTE

- Voluntary movie rating system only uses an age-based rating.

### TV Parental Guidelines (TV Guidelines)

- 1 In Lock menu, press ▲/▼ to select “V-Chip”, then press ◀/▶ to select “On”.
- 2 Press ▲/▼ to select “V-Chip Set”, then press ▶ or **ENTER**.
- 3 Press ▲/▼ to select “TV Rating”, then press ▶ or **ENTER**.
- 4 Press ▲/▼/◀/▶ to select the desired rating, then press **ENTER**.
- 5 Press **EXIT** to return to the normal screen.

### Voluntary movie rating system (MPAA)

- 1 Repeat steps 1 and 2 in **TV parental Guidelines (TV Guidelines)**.
- 2 Press ▲/▼ to select “Movie Rating”, then press ▶ or **ENTER**.
- 3 Press ▲/▼ to select the desired rating, then press **ENTER**.
- 4 Press **EXIT** to return to the normal screen.

## Watching TV

### Canadian rating systems

- The TV rating systems in Canada are based on the Canadian Radio-Television and Telecommunications Commission (CRTC) policy on violence in television programming.
- While violence is the most important content element to be rated, the structure developed takes into consideration other program content like language, nudity, sexuality and mature themes.
- When setting the V-CHIP on the Canadian system you can choose either the Canadian English ratings or the Canadian French ratings.

### Canadian English ratings

Rating		Description
Age	E	Exempt: Includes news, sports, documentaries and other information programming; talk shows, music videos, and variety programming.
	C	Children: Intended for younger children under the age of 8 years. Pays careful attention to themes that could threaten their sense of security and well-being.
	C8+	Children over 8 years old: Contains no portrayal of violence as the preferred, acceptable, or only way to resolve conflict; nor encourage children to imitate dangerous acts which they may see on the screen.
	G	General: Considered acceptable for all age groups. Appropriate viewing for the entire family, contains very little violence, physical, verbal or emotional.
	PG	Parental Guidance: Intended for a general audience, but may not be suitable for younger children (under the age of 8) because it could contain controversial themes or issues.
	14+	Over 14 Years: Could contain themes where violence is one of the dominant elements of the storyline, but it must be integral to the development of plot or character. Language usage could be profane and nudity present within the context of the theme.
18+	Adults: Intended for viewers 18 years and older and might contain depictions of violence, which while related to the development of plot, character or themes, are intended for adult viewing. Could contain graphic language and portrayals of sex and nudity.	

**Example:** If you select “G”, this will automatically block the higher ratings “PG”, “14+” and “18+”.

### Canadian French ratings

Rating		Description
Age	E	Exempt programming.
	G	General: All ages and children, contains minimal direct violence, but may be integrated into the plot in a humorous or unrealistic manner.
	8 ans+	General but inadvisable for young children: May be viewed by a wide public audience, but could contain scenes disturbing to children under 8 who cannot distinguish between imaginary and real situations. Recommended for viewing with parent.
	13 ans+	Over 13 years: Could contain scenes of frequent violent scenes and therefore recommended for viewing with parent.
	16 ans+	Over 16 years: Could contain frequent violent scenes and intense violence.
	18 ans+	Over 18 years: Only for adult viewing. Could contain frequent violent scenes and extreme violence.

**Example:** If you select “8 ans+”, this will automatically block the higher ratings “13 ans+”, “16 ans+” and “18 ans+”.

### Canadian English ratings

- 1 Repeat steps 1 and 2 in **TV parental Guidelines (TV Guidelines)**.
- 2 Select “CAN ENG Rating”, then press ► or **ENTER**. Press ▲/▼ to select E, C, C8+, G, PG, 14+ or 18+, then press **ENTER**.
- 3 Press **EXIT** to return to the normal screen.

### Canadian French ratings

- 1 Repeat steps 1 and 2 in **TV parental Guidelines (TV Guidelines)**.
- 2 Select “CAN FRE Rating”, then press ► or **ENTER**. Press ▲/▼ to select E, G, 8 ans+, 13 ans+, 16 ans+ or 18 ans+, then press **ENTER**.
- 3 Press **EXIT** to return to the normal screen.

### How to temporarily release the V-Chip block

The V-Chip block is working and censors a broadcast, “This program has been blocked!” displays.

- 1 Press **MUTE** while the V-Chip is working and then the password entering menu displays.
- 2 Enter your 4-digit password with **0–9**, then press **ENTER**.  
At this time V-Chip block temporarily releases.

**Reactivating the temporarily released V-Chip block**  
**Method 1:** Change to the other channel.

**Method 2:** Switch off the TV power.

#### NOTE

- Performing any of the two above will activate the V-Chip block.



# Other convenience functions

## Menu operation buttons

Use the following buttons on the remote control to operate the menu.

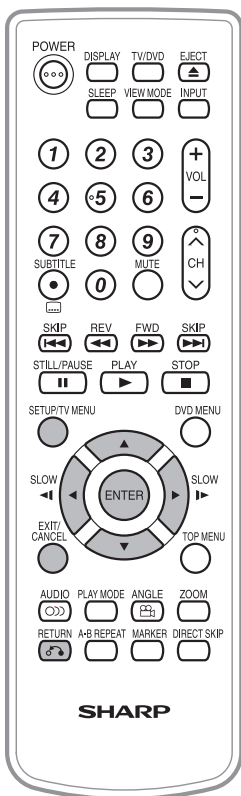

## Quick guide for MENU operation

**example : Select Language**

1 Press **TV MENU** and the MENU screen displays.



2 Press **▲/▼** to select "Setup", then press **▶** or **ENTER**.

Press **▲/▼** to select "Language".

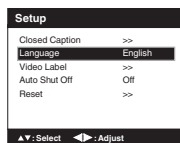

3 Press **◀/▶** to select the desired language.  
...on the following pages the MENU can be called in the same way as here.

4 Press **EXIT** to return to the normal screen.

### NOTE

- Some menu items may not displayed depending on the selected input source.
- If no buttons are pressed for more than approx. 60 seconds, the menu screen will return to normal Monitor screen automatically.

**TV MENU:** Press to open the menu screen.

**▲/▼/◀/▶:** Press to select a desired item on the screen or adjust a selected item.

**ENTER:** Press to go to the next step or complete the setting.





**RETURN:** Press to return to the previous step.

**EXIT:** Press to exit from the menu screen.  
All changed settings will be saved.

▲▼: Select   ◀▶: Adjust   ENTER: Set

The lower part of the menu screen is an operational guide for the remote control. It will change in accordance with each menu setting screen.

## Other convenience functions

Icon	Selected item		Description	
	Picture Setting	Brightness / Contrast / Sharpness / Color / Tint	You can adjust the picture quality to your preference.	
		Color Temperature	Bluish (Cool) / Neutral (Standard) / Reddish (Warm)	
		Backlight	Backlight adjusts the screen brightness for improved picture clarity.	
	AV Mode	Sports	For a clear-cut image emphasizing high contrast, useful for sports viewing.	
		Standard	For a highly defined image in a normal lighting.	
		Movie	For a movie.	
		Memory	Allows the user to customize settings as desired. You can set the mode for each input source.	
	View Mode		See page 18.	
	Film Mode	On / Off	A smoother motion may be obtained by setting the Film Mode to "On" when you view a DVD from the DVD player.	
	PC Setting* (see page 25)	Hor Position / Ver Position		To adjust the horizontal / vertical position of the image on the PC Monitor screen. Each video standard will require a different value for this setting.
Clock		To minimize any vertical bars or stripes visible on the screen background.		
Phase		This must be adjusted after the frequency has been set optimize picture quality.		
Auto Adjust		To adjust the all PC settings automatically.		
DNR	On / Off	DNR (Digital Noise Reduction) can reduce the roughness of the picture. (This function is available only for analog broadcast.)		
	Bass / Treble / Balance		You can adjust the sound quality to your preference.	
	MTS	Stereo / SAP / Mono	See page 17.	
	Surround	On/Off	The dynamic presence and sound created offers a thoroughly enjoyable listening experience.	
	Audio Language		When two or more audio languages are included in a digital signal, you can select one of the audio languages.	
	HDMI Audio	HDMI		When you connect the HDMI device to the TV, select this setting.
		DVI		When you connect the DVI device to the TV with analog audio cords, select this setting.
	Add/Delete	Adding Channel / Add/ Delete / Clear All	See page 17.	
	DTV Signal		Select "DTV Signal", then press ► or ENTER. The Digital-Signal strength screen will appear. If necessary, adjust the direction of the antenna to obtain the maximum signal strength.	
	Auto Ch Memory	Signal Type / Automatic Search	See page 17.	
	Ch Label	Channel Number / Ch Label / Label Clear	See page 17.	
			See pages 20~22.	
	Closed Caption		See page 19.	
	Language	English / Français / Español	You can choose from three different languages (English, French and Spanish) for the on-screen displays.	
	Video Label		Let you set the input terminal displayed when using the "Source Selection" menu or channel display. Press ▲/▼ to select the specific input source which you want to change. Press ◀/▶ to select the new label for the selected input source.	
	Auto Shut Off	On / Off	In case of "Auto Shut Off" feature is "On", if a station being viewed stops broadcasting, the TV will automatically shut itself off after 15 minutes. <ul style="list-style-type: none"> <li>If Auto Shut Off is "On" and the broadcast signal is weak, the TV may automatically shut itself off. If this happens, turn Auto Shut Off to "Off".</li> </ul>	
	Reset		The Reset function returns your settings to the factory settings.	

### NOTE

- \* "PC Setting" is available only for PC INPUT (INPUT4).
- \* When you connect the PC via HDMI input, you can setting "Hor Position" and "Ver Position" only.
- \* Whenever you change the PC display resolution settings and find that the characters of the PC input has rough edges or has some flickering, please go to PC Setting and do an "Auto Adjust" to improve the display of the PC input.

# Connecting a PC (Personal computer)

## Viewing an image from a PC

Use the INPUT4 (PC) terminals to connect a PC. (When you use HDMI cable, use the INPUT3 (HDMI) terminals.)

### NOTE

- The PC input terminals are DDC1/2B-compatible.
- Refer to "PC compatibility chart" for a list of PC signals compatible with the System.
- Make sure to select the same signal values for the output signal of a PC and the input signal of the TV/DVD set before connecting with the PC. (See page 24.)
- Depending on the PC being used, images may not be shown without converting the output signals into external output. Please refer to your PC's manuals regarding converting to external output.
- You can also connect the PC with HDMI cable. If you use HDMI cable, you don't have to connect the audio cord. If you use HDMI-to-DVI cable, please connect audio cord as same way as VGA cable.

### Connecting the RGB cable



- Connect the RGB cable making sure that it fits correctly into the terminal. Then, firmly secure the connectors by tightening the screws on both sides of the plug.

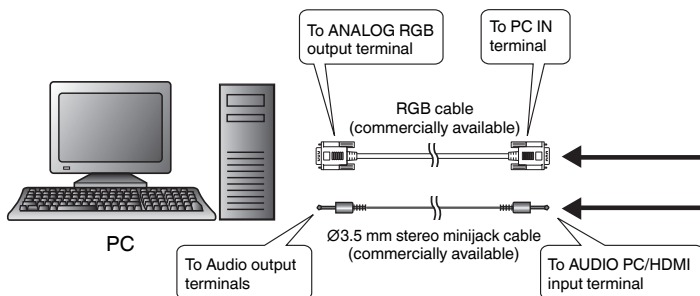
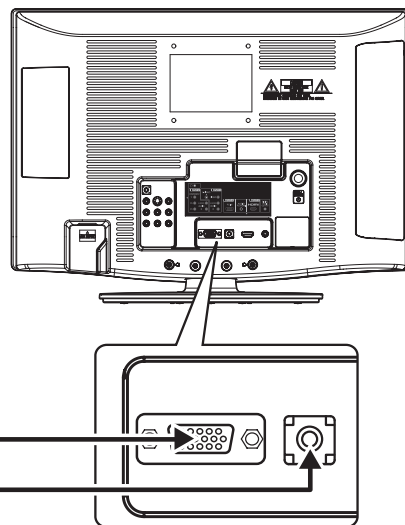

### Signal names for 15-pin mini D-sub connector

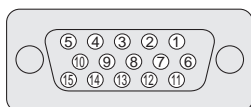

Pin No.	Signal name	Pin No.	Signal name
①	R	⑨	DSUB_5
②	G	⑩	GND (Ground)
③	B	⑪	Not connected
④	Not connected	⑫	DDCD
⑤	DGND (Ground)	⑬	VGHS
⑥	AGND (Ground)	⑭	VGVS
⑦	AGND (Ground)	⑮	DDCC
⑧	AGND (Ground)		

## Displaying an image from a PC

To view an image from a PC, perform the following procedure.

- ① Select the Input4 (PC) mode using **INPUT** on the remote control or the TV/DVD set. (See page 15.)
- ② Select the PC input signal.
- ③ Adjust the "Picture" items if the PC image does not come in clearly. (See page 24.)

## PC compatibility chart

PC	Resolution	Horizontal Frequency	Vertical Frequency	VESA Standard	
PC	VGA	720 x 400	31.5 kHz	70 Hz	-
			31.5 kHz	60 Hz	○
		640 x 480	37.9 kHz	72 Hz	○
	SVGA	800 x 600	37.5 kHz	75 Hz	○
			35.1 kHz	56 Hz	○
			37.9 kHz	60 Hz	○
			48.1 kHz	72 Hz	○
			46.9 kHz	75 Hz	○
	XGA	1,024 x 768	48.4 kHz	60 Hz	○
			56.5 kHz	70 Hz	○
			60.0 kHz	75 Hz	○
	WXGA	1,280 x 720	44.8 kHz	60 Hz	○
1,280 x 768		47.8 kHz	60 Hz	-	
1,360 x 768		47.7 kHz	60 Hz	○	

# Watching the DVD

## Preparation

Perform the following steps before you press **POWER** on the remote control unit.

- 1 Insert the batteries into the remote control unit. (See page 10.)
- 2 Plug in the AC cord to the AC outlet. (See page 9.)

## Turning on the power

Press **POWER** on the TV/DVD, or **POWER** on the remote control.

- POWER indicator (Green): The TV/DVD is on. ("Please wait" will appear for a few seconds on the screen.)

## Select the DVD mode

Press **TV/DVD** to select the DVD mode.

## Turning off the power

Press **POWER** on the TV/DVD, or **POWER** on the remote control.

- The TV/DVD enters standby mode and the image on the screen disappears.
- The POWER indicator on the TV/DVD changes to Red.

### NOTE

- If you are not going to use this TV/DVD for a long period of time, be sure to remove the AC cord from the power outlet.
- Weak electric power is still consumed even when **POWER** is turned off.

## Playback procedure

- 1 Place the disc in the disc slot with the label side facing forward. (If the disc has a label.) Hold the disc without touching its surface, align it with the guides, and place it in position.
  - If a disc is inserted during some modes other than DVD mode, it may switch to DVD mode and then playback may be begun automatically.

### NOTE

- If a non-compatible disc is loaded, "Incorrect Disc", "Region Code Error" or "Parental Error" will appear on the TV screen according to the type of loaded disc. If these appear, check your disc again (see pages 6 and 33).
- Some discs may take a minute or so to start playback.
- When an 8 cm disc is placed into the disc slot, and the playback picture or menu display does not appear, press **PLAY**.
- A "Prohibition" symbol "X" may appear at the upper right of the screen. This symbol means either the feature you tried is not available on the disc, or the TV/DVD cannot access the feature at this time. This does not indicate a problem with the TV/DVD.
- When you set a single-faced disc label downwards (i.e. the wrong way up) "Reading" will appear on the display and then "Incorrect Disc" will be displayed.
- Some playback operations of DVDs may be intentionally fixed by software producers. Since this TV/DVD plays DVDs according to the disc content recorded, some playback features may not be available. Also refer to the instructions supplied with the DVDs.
- Do not move the unit during playback. Doing so may damage the disc.
- Use **EJECT** to unload and eject the disc.
- Do not put any objects other than discs on the disc slot. Doing so may cause the unit to malfunction.
- In many instances, a menu screen will appear after playback of a movie is completed. Prolonged display of an on-screen menu may damage your television set, permanently etching that image onto its screen. To avoid this, be sure to press **POWER** on your remote control once the movie is completed.
- There may be a slight delay between the button is pressed and the function activates.

- 2 On the screen, "**▲**" changes to "Reading" and then playback will commence.
  - A menu screen appear on the TV screen, if the disc has a menu feature. In this case, press **▲/▼/◀/▶** or **ENTER** to operate a menu feature.
- 3 Press **STOP** to end playback.
  - The unit memorizes the stopped point, depending on the disc. "**■**" appears on the screen. Press **PLAY** to resume playback (from the scene point).
  - If you press **STOP** again ("**■**" appears on the screen) or unload the disc, the TV/DVD will clear the stopped point.
- 4 Press **EJECT**.  
Remove the disc and then press **POWER**.  
The TV/DVD turns off.
  - When you eject the disc, you may hear mechanism noise, but it is not malfunction.

## Status display of DVD disc

Press **DISPLAY**. The status display of the disc will appear on the screen in order like the figure below.

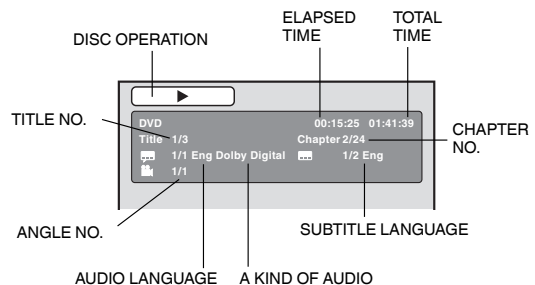

### NOTE

- **If the TV/DVD does not operate properly:**  
Static electricity, etc., may affect the player's operation. Disconnect the AC power cord once, then connect it again.
- If a disc is inserted during some modes other than DVD mode, it may switch to DVD mode and then playback may be begun automatically.
- **About inserting disc:**  
If the unit is slanted or moved while inserting disc, the disc may get damage.

## Watching the DVD

### Special playback

#### Fast Forward Playback

Press **FWD** during normal playback.

Each press of **FWD** will increase the speed of the search **▶▶** (x 2), **▶▶▶** (x 4), **▶▶▶▶** (x 8), **▶▶▶▶▶** (x 20).

- To resume normal playback, press **PLAY**.
- The above figure shown in parentheses indicates the average speed multiplier.

#### Review Playback

Press **REV** during normal playback.

Each press of **REV** will increase the speed of the search **◀◀** (x 2), **◀◀◀** (x 4), **◀◀◀◀** (x 8), **◀◀◀◀◀** (x 20).

- To resume normal playback, press **PLAY**.
- The above figure shown in parentheses indicates the average speed multiplier.

#### Still Playback

Press **STILL/PAUSE** during normal playback to pause playback.

- To resume normal playback, press **PLAY**.

#### Frame Advance

Press **STILL/PAUSE** during still playback.

One frame is advanced each time you press **STILL/PAUSE**.

- To resume normal playback, press **PLAY**.

#### Slow-motion Playback

Press **SLOW (▶|)** or **SLOW (◀|)** during normal playback or still playback.

Each press of **SLOW** will change the speed of the slow x1/2, x1/4, x1/6, x1/7.

- To resume normal playback, press **PLAY**.
- To resume the still playback, press **STILL/PAUSE**.

#### Locating a chapter or track

Press **SKIP(▶▶|)** Forward or **SKIP(|◀◀)** Reverse during playback to locate a chapter that you want to watch.

Each time you press the button, a chapter or track is skipped.

#### NOTE

- The TV/DVD is capable of holding a still video image or On screen display image on your television screen indefinitely. If you leave the still video image or On screen display image displayed on your TV for an extended period of time, you risk permanent damage to your television screen.

### Zooming

This TV/DVD will allow you to zoom in on the frame image. You can then make selections by switching the position of the frame.

- 1 Press **ZOOM** during playback.  
The center part of the image will be zoomed in.  
Each press of **ZOOM** will change the ZOOM magnification **Q<sub>1</sub>** (x 1.3), **Q<sub>2</sub>** (x 1.5) and **Q<sub>3</sub>** (x 2.0).
- 2 Press **▲/▼/◀/▶** to view a different part of the frame. You may move the frame from the center position UP, DOWN, LEFT or RIGHT.
- 3 In the zoom mode press **ZOOM** repeatedly to return to a 1:1 view (**Q Off**).

#### NOTE

- You can select the Still Playback or Fast Forward (Review) Playback in the zoom mode.
- Some discs may not respond to zoom feature.

### Locating desired scene

Use the title, chapter and time recorded on the disc to locate the desired point to play back.

- 1 Press **DIRECT SKIP** during playback.
- 2 Press **▲/▼** to select the "Title", "Chapter" or "Time".
- 3 Press **Number buttons (0-9)** to input the number.
  - If you input a wrong number, press **CANCEL**.
  - Refer to the package supplied with the disc to check the numbers.
- 4 Press **ENTER**.
  - Playback starts.
  - When you change the title, playback starts from Chapter 1 of the selected title.
  - Some discs may not work in the above operation.

### Repeat playback

- 1 Press **PLAY MODE** during playback or stop mode.
- 2 Press **ENTER** to select "Chapter" or "Title".
  - The unit automatically starts repeat playback after finishing the current title or chapter.Press **PLAY MODE** again to make the screen disappear.
  - If you set the repeat mode during stop mode, press **PLAY** to start Repeat playback.
  - To resume normal playback, select Repeat "Off".

#### NOTE

- Some discs may not be compatible with the repeat operation.
- Chapter repeat function is canceled whenever **SKIP(▶▶|)** Forward or **SKIP(|◀◀)** Reverse is pressed.

### A-B Repeat playback

A-B repeat playback allows you to repeat material between two selected points.

- 1 Press **A-B REPEAT** during playback.  
The start point is selected.
- 2 Press **A-B REPEAT** again.  
The end point is selected.  
Playback starts at the point that you selected. Playback stops at the end point, returns to Point A automatically, then starts again.
  - To resume normal playback press **A-B REPEAT** again.  
"Off" appears on the screen.

#### NOTE

- In A-B Repeat mode, subtitles near the A or B locations may not be displayed.
- You cannot set the A-B Repeat for the scenes that include multiple angles.
- You may not be able to set A-B Repeat during certain scenes of the DVD.
- A-B Repeat does not work with an interactive DVD, MP3/WMA/JPEG-CD.

## Watching the DVD

### Marking desired scenes

The TV/DVD stores the points that you want to watch again up to 3 points.

You can resume playback from each scene.

#### Marking the scenes

- 1 Press **MARKER** during playback.
- 2 Select the blank Marker using **▲/▼**, then press **ENTER** at the desired scene.
  - Up to 3 scenes can be selected.
  - Repeat this procedure to set the other 2 scenes.
- 3 Press **MARKER** to return to the normal screen.

#### Returning to the scenes

- 1 Press **MARKER** during playback or stop mode.
- 2 Press **▲/▼** to select the Marker 1-3.
- 3 Press **ENTER**.  
Playback starts from the marked scene.

#### To cancel the Marker

Follow the above steps 1~2, then press **CANCEL**.

#### NOTE

- Some discs may not work with the marking operation.
- The marking is cancelled when you eject the disc or turn the power off.
- Some subtitles recorded around the marker may fail to appear.

### Changing angles

When playing back a disc recorded with multi-angle facility, you can change the view angle.

- 1 Press **ANGLE** during playback.  
The current angle will appear.



- 2 Press **ANGLE** repeatedly until the desired angle is selected.

#### NOTE

- In case of JPEG-playback, the JPEG-image is rotated 90 degrees to the right.
- Depending on the DVD, you may not be able to change the angles even if multi-angles are recorded on the DVD.

### Changing soundtrack language

You can select the language when you play a multilingual disc.

- 1 Press **AUDIO** during playback.  
The current soundtrack language will appear.

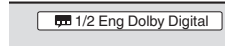

- 2 Press **AUDIO** repeatedly until the desired language is selected.  
The on-screen display will disappear after a few seconds.

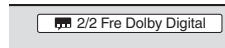

#### NOTE

- If the desired language is not heard after pressing **AUDIO** several times, the language is not recorded on the disc.
- Changing soundtrack language is cancelled when you eject the disc.  
The initial default language or available language will be heard if the disc is played back again.

### Subtitles

#### Changing the subtitle language

You can select the language when playing back a disc recorded with multilingual subtitles.

- 1 Press **SUBTITLE** repeatedly during playback until your desired language appears.  
The on-screen display will disappear after a few seconds.



#### Turning the subtitles on and off

Press **SUBTITLE** during playback until "Off" appears.

#### NOTE

- Changing subtitle language is cancelled when you eject the disc.
- Some functions may not work on some DVDs. You may not be able to turn subtitles on or off or change subtitles.  
While playing the DVD, the subtitle may change when:
  - you eject or insert the disc.
  - you change the title.
- In some cases, the subtitle language is not changed to the selected one immediately.

# MP3/WMA/JPEG and Audio CD operation

This TV/DVD can playback the MP3/WMA/JPEG-data which has been recorded on CD-R or CD-RW. Audio CD also can be played back. To produce the MP3/WMA/JPEG-data, you need a Windows-PC with CD-R/RW drive and a MP3/WMA/JPEG-encoding Software (not supplied).

The Apple-HFS-System cannot be played.

## NOTE

This TV/DVD requires discs/recordings to meet certain technical standards in order to achieve optimal playback quality. Pre-recorded DVDs are automatically set to these standards. There are many different types of recordable disc formats (including CD-R containing MP3/WMA files). Given the fact that technology in this area is still maturing, this unit cannot guarantee that all genre of recordable discs will produce optimal playback quality. The technical criteria set out in this owner's manual are meant as a guide only.

Please be advised that you must obtain permission from the applicable copyright owners to download copyrighted content, including music files, in any format, including the MP3 and WMA formats, prior to the downloading thereof.

## MP3/WMA/JPEG CD information

### Limitations on MP3/WMA/JPEG CD playback

- MP3/WMA/JPEG CD is the disc that is standardized by ISO9660, its file name must include 3-digits extension letters, "mp3", "wma", "jpg".
- MP3/WMA/JPEG CD must be correspond to the ISO standardized files.
- This TV/DVD can read 2000 files per disc. If one disc has more than 2000 files, it reads up to 2000 files, the remaining files will be omitted.
- MP3/WMA/JPEG CDs cannot be used for the purpose of recording.
- It may take more than one minute for this unit to read MP3/WMA/JPEG files depending on its structure.
- Music recorded by "Joliet Recording Specification" can be played back, the file name is displayed (within 15 letters) on the screen. Long file names will be condensed.
- The music files recorded by "Hierarchical File System" (HFS) cannot be played.

### Limitations on display

- The maximum number for display is 15 letters.

### Notes on MP3/WMA/JPEG files

To playback MP3/WMA/JPEG CD in the recorded order,

1. Use MP3/WMA/JPEG software that records data alphabetically or numerically.
2. Name each file including two-digit or three-digit number (ex. "01" "02" or "001" "002").
3. Refrain from making too many sub-folders.

### CAUTION:

- Some MP3/WMA/JPEG CDs cannot be played back depending on the recording conditions.
- The CD-R/RW that has no music data or non MP3/WMA/JPEG files cannot be played back.

### Standard, sampling frequency, and the bit rate:

#### MP3 CD

MPEG-1 Audio

32kHz, 44.1kHz, 48kHz

32kbps ~ 320kbps (constant bit rate or variable bit rate)

The recommend recording setting for a high-quality sound is 44.1kHz of sampling frequency and 128kbps of constant bit rate.

#### WMA CD

WMA version 7, and 8

32kHz, 48kbps

44.1kHz, 48kbps ~ 192kbps

48kHz, 128kbps ~ 192kbps

The file recorded by mono, 48kHz, 48 kbps is not available to this unit.

Microsoft, Windows Media, and the Windows Logo are either registered trademarks or trademarks of Microsoft Corporation in the United States and/or other countries.

## MP3/WMA/JPEG and Audio CD operation

### Loading CD

- 1 Load a disc on which MP3 or WMA files have been recorded in the disc slot.
- 2 "Reading" will appear on the TV screen. Reading time will depend on the number of files on the disc.
- 3 A file browser screen will appear on the TV screen.

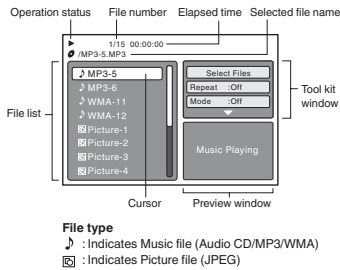

- In case the current directory includes 8 files or more, press **▲/▼** to scroll in the file list.
- To see contents in folder, select the folder and then press **ENTER**. To return to the parent directory, select **Go Up ...** then press **ENTER**.
- In case of a CD containing a mixture of MP3, WMA and JPEG files, the files are played back by selecting them from the file browser.

### MP3/WMA and Audio CD playback

- 1 In the file browser, press **▲/▼** to select the desired file.
  - When **PLAY** is pressed after displaying file browser displayed, playback begins automatically starting from the first file. In this case, if the first file is an MP3/WMA file, only MP3/WMA files are played back in order. If the first file is a JPEG file, the first JPEG file is played back. If there is no file at a root directory, playback does not begin automatically.
- 2 Press **ENTER**.  
The selected file starts playing back.
- 3 Press **STOP** to end playback.
  - The unit records the stopped point. **■** appears on the screen. Press **PLAY** to resume playback (from the scene point).
  - If you press **STOP** again or unload the disc, the unit will clear the stopped point.

#### NOTE

- During MP3/WMA/JPEG-Playback, you cannot use **DIRECT SKIP** and **A-B Repeat** functions.
- You can use **Repeat (Track or All)**, **Random** functions and **Program** playback for MP3/WMA/JPEG-Playback (see page 31).

### Select Files

The file type to make it display in the file browser can be chosen.

- 1 Press **◀/▶** to select "Select Files" at right column in the file browser.
  - Press **ENTER**, then press **▲/▼** to select file type from the list (Music or Picture).
- 2 Press **ENTER** to add/remove check mark. Checked file type will be displayed in the file browser.
- 3 Press **RETURN** to save the setting.

### JPEG playback

- 1 In the file browser, press **▲/▼** to select the desired JPEG file.  
To display a thumbnail list, press **DVD MENU**.  
Press **◀/▶/▲/▼** to select the desired file.  
(To return to the file browser, press **TOP MENU**.)
  - When **PLAY** is pressed after displaying the file browser, playback begins automatically starting from the first file. In this case, if the first file is a JPEG file, the first JPEG file is played back. If the first file is an MP3/WMA file, only MP3/WMA files are played back in order. If there is no file at a root directory, playback does not begin automatically.
- 2 Press **ENTER**. The selected picture appears on the screen.  
**Rotating an image**  
You can rotate an image by 90 degrees.  
Press **ANGLE** during playback of the image.  
"**↶**", "**↷**", "**↵**" or "**↶↷**" appears on the screen.  
**Zooming an image**  
Zoom function also can be used in viewing JPEG files.  
Press **ZOOM** (see "Zooming" on page 27).
- 3 Press **STOP** to end playback.
  - The file browser appears on the screen. If you want to watch the other file, repeat steps 1 ~ 2.

#### NOTE

- When an image exceeds 5760 x 3840 pixels, the entire image cannot be displayed on a screen, preview window or thumbnail list.

### Slide show playback

The slide show enables you to view pictures (files) one after another automatically.

#### Preparation:

Set "JPEG Interval" setting to "5 Seconds", "10 Seconds" or "15 Seconds" (see page 32).

- 1 Select your desired starting file for the slide show in step 1 on the above.
- 2 Press **ENTER** or **PLAY** to start slide show from the selected file.
  - If you press **STILL/PAUSE** during the slide show, the slide show stops temporary. **||** appears briefly on the screen.
  - If the picture appears upside down or sideways, press **ANGLE** repeatedly until it's right side up. "**↶**", "**↷**", "**↵**" or "**↶↷**" appears on the screen.
  - Press **PLAY** or **SKIP** **▶▶** again to resume the slide show.
  - When the slide show playback finished, the file list appears.
  - To stop the slide show, press **STOP**. The file list appears.

#### NOTE

- During JPEG playback, you cannot use **Direct Skip** and **A-B Repeat** functions.
- It may have a longer interval due to a size of data.



### Repeat playback (CD)

- 1 In the file browser, press **▲/▼/◀/▶** to select "Repeat" during stop mode.
- 2 Press **ENTER** repeatedly to select "Track" or "All".
- 3 Press **PLAY**.
  - The unit automatically starts repeat playback after finishing the current track.

#### To resume normal playback

Select Repeat : "Off" in step 2.

#### NOTE

- The repeat or random function is canceled when you eject the disc or turn the power off.
- The track repeat function is canceled when **SKIP ◀◀** or **▶▶** is pressed.
- In case of Audio CD, the function of A-B Repeat also can be used. See "A-B Repeat playback" (see page 27).

### Random playback (CD)

- 1 In the file browser, press **▲/▼/◀/▶** to select "Mode" during stop mode.
- 2 Press **ENTER** to select "Random".
- 3 Press **PLAY**.
  - The Random playback will start.

#### To resume normal playback

Select Mode : "Off" in step 2.

### Program playback (CD)

- 1 In the file browser, press **▲/▼/◀/▶** to select "Edit Mode" during stop mode, then press **ENTER**.
  - When "Edit Mode" is black color, you can mark the files which you want to add into Program list.
- 2 Press **◀/▶/▲/▼** to select the file you want to add into the program list.
  - Press **ENTER**. Selected file was marked.
  - Repeat this procedure to select the other files.
- 3 Press **◀/▶/▲/▼** to select "Add To Program". Then press **ENTER**. All marked files are added into the program list.
  - When you finish storing the files you want into the Program list, select "Edit Mode" again and press **ENTER** to release edit mode.
- 4 Press **▲/▼** to select "Program View", then press **ENTER**. Program View shows only the programmed files that you have added in Step 2.
- 5 In the Program View, press **PLAY**. The files start to playback in programmed order that were added by you.

#### To remove file from program list in stop mode

In the Edit Mode, switch to Program View. Select the files you want to remove, then press **ENTER**. Select "Clear Program" and press **ENTER**. Marked file is removed from program list.

#### NOTE

- The program function is canceled when you eject the disc or turn the power off.

### Basic operation buttons

Use the following buttons on the remote control to operate the menu.

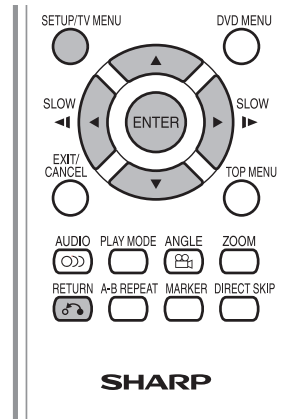

- SETUP:** Press to open or close the menu screen.
- During stop mode, the DVD SETUP screen displays.
  - During playback mode, the TV MENU displays.

**▲/▼/◀/▶:** Press to select a desired item on the screen or adjust a selected item.

**ENTER:** Press to go to the next step or complete the setting.

**RETURN:** Press to return to the previous step.

### Quick guide for DVD MENU operation





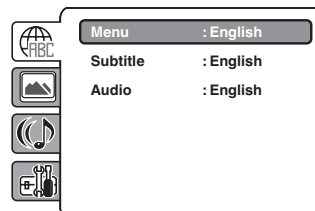

#### example: Setting the language

- 1 Press **SETUP** and the SETUP screen displays.
- 2 Press **▲/▼** to select (LANGUAGE), then press **◀/▶** or **ENTER**.



- 3 Press **▲/▼** to select desired option, then press **▶** or **ENTER**.
- 4 Press **▲/▼** to select your desired language (e.g. English), then press **ENTER**.
- 5 Press **SETUP** to return to the normal screen.

## Function Setup

Icon			Description
Language <sup>1</sup> 	Menu <sup>1</sup> Subtitle <sup>1</sup> Audio <sup>1</sup>	English / Francais / Espanol	The selected language will be heard or seen.
		Other	Other language can be selected (see the "Language code list" on page 34).
		Off (subtitle)	Subtitles do not appear.
		Original (Audio)	The unit will select the first priority language of each disc.
Picture 	TV Screen <sup>2</sup>	4:3  (Letter box)	When playing back a wide screen-DVD disc, it displays the wide picture with black bands at the top and bottom of screen.
		4:3  (Pan Scan)	It displays the wide picture on the whole screen with left and right edges automatically cut off.
		16:9  (Wide)	Select this mode when connecting to a wide-screen TV. A wide screen picture is displayed full size.
	Display <sup>3</sup>	Off / On	On screen display can be switched on or off when you press any buttons.
	Picture Mode	There are two types of source content in pictures recorded in DVD video discs: film content (pictures recorded from films at 24 frames per second) and video content (video signals recorded at 30 frames per second). Make this selection according to the type of content being viewed.	
		Auto	Select this position normally. The DVD player automatically detects source content, film or video, of playback source.
		Film	Suitable for playback of film content pictures.
		Video	Suitable for playback of video content pictures.
	JPEG Interval <sup>4</sup>	You can continuously playback all JPEG files automatically.	
		Off	Plays back one file at a time.
5 / 10 / 15 Seconds		Displays images in the form of a slide show. Every 5 / 10 / 15 seconds the image changes.	
Audio 	Night Mode <sup>5</sup>	Night Mode enables you to control the dynamic range so as to achieve a suitable sound for your equipment.	
		Off	It plays back at the recording level on the disc.
		On	Loud sound such as explosion or similar is toned down slightly when played back. This makes it suitable for when it is connected to a stereo.
	Digital Out <sup>6</sup>	You can select the digital output sound format corresponding to your system connection.	
		Off	There is no sound output from DIGITAL AUDIO OUT jack.
		PCM	Change Dolby Digital to PCM for the output. Select when connected to a 2 channel digital stereo amplifier.
	Bitstream	Disc audio bitstream data will be output.	
Setup 	Parental	See page 33.	
	Password		

### NOTE

<sup>1</sup> If the selected language is not recorded on the disc, the first priority language is selected.

<sup>2</sup> If the DVD disc is not formatted in the pan & scan style, it displays 4:3 style.

<sup>3</sup> If "Display" is not set to "On" on screen displays do not appear when you press any buttons except **SUBTITLE, PLAY MODE, MARKER, DIRECT SKIP, DISPLAY** and **AUDIO**.

<sup>4</sup> You cannot display DVD SETUP screen when disc is playback

<sup>5</sup> This function works only during playback of Dolby Digital recorded discs.

<sup>6</sup> Even if you select "Bitstream", MPEG audio will be output in PCM format.

## Function setup

### Parental control setting

Some discs are specified as not suitable for children. Playback of such discs can be restricted with this TV/DVD.

- 1 Select "Parental", then press ► or **ENTER**. "Enter Password" screen will appear.
- 2 Press "0000" using **Number buttons (0–9)**. (Please note, this is pre-setting password of this unit). Then press **ENTER**. The parental level list will appear.
  - If you input a wrong number, press **CANCEL**.

Selected item	Description
Level Off	The parental control setting does not function.
Level 8	Virtually all DVD software can be played back.
Level 1	DVD software for adults cannot be played back.

- Select from level 1 to level 8. The limitation will be more severe as the level number decreases.
- 3 Press ▲/▼ to select from the level 1 to level 8. The limitation will be more severe as the level number is lower. Then press **ENTER**.
  - 4 Press **SETUP** to return to the normal screen.
    - After the rating is locked, the setting cannot be changed unless you enter the correct password.

#### NOTE

- The password is required every time when you change the parental level.
- Depending on the discs, the TV/DVD may not be able to limit playback.
- Some discs may not be encoded with specific rating level information though its disc jacket says "adult." For those discs, the parental control feature will not work.

### Set the new password

- 1 Select "Password", then press ► or **ENTER**. "Enter Current Password" screen will appear.
- 2 Press **Number buttons (0-9)** to enter the password you have stored.
  - If you input a wrong number, press **CANCEL**.
- 3 Then press **ENTER**. "Enter New Password" screen will appear. Press **Number buttons (0–9)** to input the new password.
- 4 Press **ENTER**. Now your new password has been set. Be sure to remember this number!

#### NOTE

##### If you forget the password...

1. Press **EJECT** to remove the disc.
2. While holding **7** down on the remote control and at the same time press **STOP** on the front panel. "Password Clear" appears on the screen. Now the password has been returned to the initial value ("0000").

### Temporary disabling of rating level by DVD disc

Depending on the DVD disc, the disc may try to temporarily cancel the rating level that you have set. It is up to you to decide whether to cancel the rating level or not.

- 1 Load a DVD disc. (See page 26.)
- 2 If the DVD disc has been designed to temporarily cancel the rating level, the screen which follows the "Reading" screen will change, depending on which disc is played. If you select "YES" with pressing **ENTER**, password input screen will then appear.
- 3 Enter the password with **Number buttons (0–9)**. Then press **ENTER**.
  - If you interrupt the entering, press **RETURN**.
- 4 Playback will commence if the entered password was correct.



#### NOTE

- This temporary cancellation of the rating level will be kept until the disc is ejected. When the disc is ejected, the original rating level will be set again automatically.

# Appendix

## Language code list

Enter the appropriate code number for the initial settings “Menu”, “Subtitle” and/or “Audio” (see page 32).

Language Name	Code	Language Name	Code	Language Name	Code	Language Name	Code
Abkhazian	1112	Fiji	1620	Lingala	2224	Singhalese	2919
Afar	1111	Finnish	1619	Lithuanian	2230	Slovak	2921
Afrikaans	1116	French	1628	Macedonian	2321	Slovenian	2922
Albanian	2927	Frisian	1635	Malagasy	2317	Somali	2925
Amharic	1123	Galician	1722	Malay	2329	Spanish	1529
Arabic	1128	Georgian	2111	Malayalam	2322	Sundanese	2931
Armenian	1835	German	1415	Maltese	2330	Swahili	2933
Assamese	1129	Greek	1522	Maori	2319	Swedish	2932
Aymara	1135	Greenlandic	2122	Marathi	2328	Tagalog	3022
Azerbaijani	1136	Guarani	1724	Moldavian	2325	Tajik	3017
Bashkir	1211	Gujarati	1731	Mongolian	2324	Tamil	3011
Basque	1531	Hausa	1811	Nauru	2411	Tatar	3030
Bengali; Bangla	1224	Hebrew	1933	Nepali	2415	Telugu	3015
Bhutani	1436	Hindi	1819	Norwegian	2425	Thai	3018
Bihari	1218	Hungarian	1831	Oriya	2528	Tibetan	1225
Breton	1228	Icelandic	1929	Panjabi	2611	Tigrinya	3019
Bulgarian	1217	Indonesian	1924	Pashto, Pushto	2629	Tonga	3025
Burmese	2335	Interlingua	1911	Persian	1611	Turkish	3028
Byelorussian	1215	Irish	1711	Polish	2622	Turkmen	3021
Cambodian	2123	Italian	1930	Portuguese	2630	Twi	3033
Catalan	1311	Japanese	2011	Quechua	2731	Ukrainian	3121
Chinese	3618	Javanese	2033	Rhaeto-Romance	2823	Urdu	3128
Corsican	1325	Kannada	2124	Romanian	2825	Uzbek	3136
Croatian	1828	Kashmiri	2129	Russian	2831	Vietnamese	3219
Czech	1329	Kazakh	2121	Samoan	2923	Volapük	3225
Danish	1411	Kirghiz	2135	Sanskrit	2911	Welsh	1335
Dutch	2422	Korean	2125	Scots Gaelic	1714	Wolof	3325
English	1524	Kurdish	2131	Serbian	2928	Xhosa	3418
Esperanto	1525	Laothian	2225	Serbo-Croatian	2918	Yiddish	2019
Estonian	1530	Latin	2211	Shona	2924	Yoruba	3525
Faroese	1625	Latvian, Lettish	2232	Sindhi	2914	Zulu	3631

## Appendix

### Troubleshooting

Problem	Possible Solution
• No power	<ul style="list-style-type: none"> <li>• Check if you pressed <b>POWER</b> on the TV/DVD, or on the remote control unit. (See page 16.)</li> <li>• Is the AC cord disconnected? (See page 9.)</li> <li>• Has the power been turned on? (See page 16.)</li> </ul>
• Unit cannot be operated.	<ul style="list-style-type: none"> <li>• External influences such as lightning, static electricity, may cause improper operation. In this case, operate the unit after first turning off the power of the TV/ DVD or unplugging the AC cord and replugging it in after 1 or 2 minutes.</li> </ul>
• Remote control unit does not operate.	<ul style="list-style-type: none"> <li>• Are batteries inserted with polarity (+, -) aligned? (See page 10.)</li> <li>• Are batteries worn out? (Replace with new batteries.)</li> <li>• Are you using it under strong or fluorescent lighting?</li> <li>• Is a fluorescent light illuminated near the remote control sensor?</li> </ul>
• Picture is cut off/with sidebar screen.	<ul style="list-style-type: none"> <li>• Are screen mode adjustments such as view mode choose made correctly? (See page 18.)</li> </ul>
• Strange color, light color, or color misalignment	<ul style="list-style-type: none"> <li>• Adjust the picture tone. (See page 24.)</li> <li>• Is the room too bright? The picture may look dark in a room that is too bright.</li> </ul>
• Power is suddenly turned off.	<ul style="list-style-type: none"> <li>• Is the sleep timer set? (See page 13.)</li> <li>• Check the Auto Shut Off settings. (See page 24.)</li> <li>• The unit's internal temperature has increased. Remove any objects blocking vent or clean.</li> </ul>
• No picture	<ul style="list-style-type: none"> <li>• Is connection to other components correct? (See page 15.)</li> <li>• Is correct input signal source selected after connection? (See page 15.)</li> <li>• Is the correct input selected? (See page 15.)</li> <li>• Is picture adjustment correct? (See page 24.)</li> </ul>
• No sound	<ul style="list-style-type: none"> <li>• Is the volume too low? (See page 13.)</li> <li>• Have you pressed <b>MUTE</b> on the remote control unit? (See page 13.)</li> </ul>
• The TV sometimes makes a cracking sound.	<ul style="list-style-type: none"> <li>• This is not a malfunction. This happens when the cabinet slightly expands and contracts according to change in temperature. This does not affect the TV's performance.</li> </ul>

### Troubleshooting-Digital broadcasting

The example of an error message displayed on a screen	Possible Solution
• Digital channel signal strength is low	<ul style="list-style-type: none"> <li>• Check the antenna cable. Check that the antenna is correctly setup.</li> </ul>
• Digital channel is scrambled	<ul style="list-style-type: none"> <li>• It is subscription channel. Contact the service provider.</li> </ul>
• Audio only	<ul style="list-style-type: none"> <li>• The channel has audio contents only.</li> </ul>

### Troubleshooting-PC mode

Problem	Possible Solution
• There is no image.	<ul style="list-style-type: none"> <li>• Make sure the RGB cable is properly connected. (See page 25.)</li> <li>• Make sure the output signal of the PC and the input signal setting of the LCD TV set are matched. (See page 25.)</li> <li>• Some software prohibit video playback on an external display when playing back a video with a notebook PC. This is not attributable to a problem with the LCD TV set.</li> </ul>
• There is no sound.	<ul style="list-style-type: none"> <li>• Make sure the PC audio cable is properly connected. (See page 25.)</li> <li>• Check if the mute function activates, or if the volume is set to minimum. (See page 13.)</li> </ul>
• The text is blurred.	<ul style="list-style-type: none"> <li>• Adjust "Clock" and "Phase" using the PC Setting menu. (See page 24.)</li> </ul>
• The image is not displayed in the center of the screen.	<ul style="list-style-type: none"> <li>• Adjust "Hor Position" and "Ver Position" using the PC Setting menu. (See page 24.)</li> </ul>

### Cautions regarding use in high and low temperature environments

- When the unit is used in a low temperature space (e.g. room, office), the picture may leave trails or appear slightly delayed. This is not a malfunction, and the unit will recover when the temperature returns to normal.
- Do not leave the unit in a hot or cold location. Also, do not leave the unit in a location exposed to direct sunlight or near a heater, as this may cause the cabinet to deform and the Liquid Crystal panel to malfunction.  
Storage temperature: -4°F to +140°F (-20°C to +60°C)

**Troubleshooting-DVD**

Problem	Possible Solution
• Playback doesn't start.	<ul style="list-style-type: none"> <li>• No disc is inserted. (See page 26.)</li> <li>• The disc may be dirty. Clean up the disc. (See page 7.)</li> <li>• The TV/DVD cannot play CD-ROMs, etc. (See page 6.)</li> </ul>
• No picture.	• TV/DVD selector is not set correctly. (See page 26.)
• No sound.	<ul style="list-style-type: none"> <li>• Check the input selector of the amplifier is set properly.</li> <li>• The TV/DVD is in the special playback mode. (See page 27.)</li> <li>• Select the correct Audio Output position on AV amplifier.</li> </ul>
• Picture is distorted during fast reverse/forward playback.	• The picture will be distorted occasionally.
• Stopping playback, search, slowmotion play, repeat play, or program play, etc. cannot be performed.	• Some discs may not do some of the functions.
• No on-screen display.	• Select Display to On. (See page 32.)
• No surround sound.	• The setup does not match your stereo system.
• The TV/DVD or remote operation key is not functioning.	• Turn off the TV/DVD and unplug the AC power cord for several minutes, then replug it.
• Playback does not start when the title is selected.	• Check the Parental setup. (See page 33.)
• Audio soundtrack and/or subtitle language is not changed when you playback a DVD.	• Multilingual language is not recorded on the DVD disc. (See page 28.)
• No subtitle.	<ul style="list-style-type: none"> <li>• Some discs have no subtitles. (See page 28.)</li> <li>• Subtitles are cleared. Press <b>SUBTITLE</b>. (See page 28.)</li> </ul>
• Angle cannot be changed.	• Multi-angles are not recorded on the DVD disc. (See page 28.)
• "X" appears on the screen.	• The function is prohibited with the TV/DVD or the disc. (See page 26.)

**CLEARING THE PASSWORD**

If you forget the password, clear the password using the following procedure.

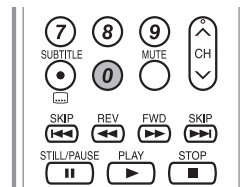
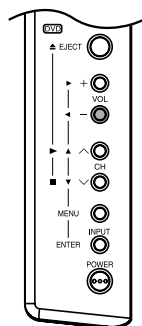

- 1 Press and hold both **VOL** – on the TV/DVD and press **0** on the remote control simultaneously for a few seconds until MENU screen appears on the screen.
- 2 Now the old password was cleared. You can set the new password.

The password is

--	--	--	--	--	--

**NOTE**

- As a precautionary measure, make a note of your password above, cut it from this manual, and keep it in a safe place.

## Appendix

### Specifications

Item		Model: LC-22DV17U	
LCD panel		22" Class (21½ Diagonal) Active Matrix (a-Si TFT LCD)	
Resolution		1,049,088 pixels (1366 x 768)	
TV Function	TV-standard (CCIR)		American TV Standard ATSC/NTSC System
	Receiving Channel	VHF/UHF	VHF 2-13ch, UHF 14-69ch
		CATV	1-135ch (non-scrambled channel only.)
		Digital Terrestrial Broadcast (8VSB)	2-69ch
		Digital Cable <sup>1</sup> (64/256 QAM)	1-135ch (non-scrambled channel only.)
Audio multiplex		BTSC System	
Audio out		1.5W x 2	
Terminals	Side	INPUT 1	AV in, S-VIDEO in
		INPUT 2	COMPONENT in, Audio in
		INPUT 3	HDMI in with HDCP, Audio in
		INPUT 4	15-pin mini D-sub female connector, Audio in (ø 3.5 mm jack)
		DIGITAL AUDIO OUTPUT	Coaxial Digital audio output x 1 (PCM/Dolby Digital)
		ANT/CABLE	75 Ω Unbalance, F Type x 1 for Analog (VHF/UHF/CATV) and Digital (AIR/CABLE)
		HEADPHONE	Mini-jack for stereo (ø 3.5 mm)
OSD language		English/French/Spanish	
Power Requirement		AC 120 V, 60 Hz	
Power Consumption		51 W (0.8 W Standby with AC 120V)	
Weight	TV + stand	11.3 lbs./5.1 kg	
	TV only	9.9 lbs./4.5 kg	
Dimension <sup>2</sup> (W x H x D)	TV + stand	21 <sup>1</sup> / <sub>8</sub> x 15 <sup>9</sup> / <sub>32</sub> x 7 <sup>59</sup> / <sub>64</sub> inch	
	TV only	21 <sup>1</sup> / <sub>8</sub> x 14 <sup>15</sup> / <sub>32</sub> x 2 <sup>41</sup> / <sub>64</sub> inch	
DVD section	Signal system		NTSC
	Applicable disc		DVD (12 cm, 8 cm), CD (12 cm, 8 cm)
	Frequency response		DVD : 4 Hz - 44K Hz / CD : 4 Hz - 20K Hz
	Wow and flutter		Below Measurable Level
	Pickup		CD : Wavelength: 780 - 790 nm Maximum output power: 7 mW DVD : Wavelength: 652 - 662 nm Maximum output power: 5 mW
Operating temperature		+41°F to +104°F (+5°C to +40°C)	

<sup>1</sup> Emergency alert messages via Cable are unreceivable.

<sup>2</sup> The dimensional drawings are shown on the inside back cover.

- Typical time for power output decrease of about one-half assuming continuous use in a room with normal lighting, normal brightness and temperature at 77°F/25°C
- As part of policy of continuous improvement, SHARP reserves the right to make design and specification changes for product improvement without prior notice. The performance specification figures indicated are nominal values of production units. There may be some deviations from these values in individual units.

# Calling for Service

For location of the nearest Sharp Authorized Service, or to obtain product literature, accessories, supplies, or customer assistance, please call 1-800-BE-SHARP.

## LIMITED WARRANTY

### CONSUMER LIMITED WARRANTY

SHARP ELECTRONICS CORPORATION warrants to the first consumer purchaser that this Sharp brand Liquid Crystal Display product (the "Product"), when shipped in its original container, will be free from defective workmanship and materials, and agrees that it will, at its option, either repair the defect or replace the defective Product or part thereof with a new or remanufactured equivalent at no charge to the purchaser for parts or labor for the period(s) set forth below.

This warranty does not apply to any appearance items of the Product or if the serial number or model number affixed to the Product has been removed, defaced, changed, altered or tampered with. This warranty does not cover installation or signal reception problems. This limited warranty will not apply if the Product has been or is being used in a commercial setting or application; this warranty is meant solely for the non-commercial, household use of the Product by consumers in their home or residence. If you intend to or already use this Product for commercial purposes or in a commercial setting, there are warranties available to cover your use of this Product, the terms of which may vary. Please contact 1-888-GO-SHARP for further information.

In order to enforce your rights under this limited warranty, you should follow the steps set forth below. You must be able to provide proof of purchase to the servicer, which proof must include the date of purchase.

To the extent permitted by applicable state law, the warranties set forth are in lieu of, and exclusive of, all other warranties, express or implied. Specifically ALL OTHER WARRANTIES OTHER THAN THOSE SET FORTH ABOVE ARE EXCLUDED, ALL EXPRESS AND IMPLIED WARRANTIES INCLUDING THE WARRANTIES OF MERCHANTABILITY, FITNESS FOR USE, AND FITNESS FOR A PARTICULAR PURPOSE ARE SPECIFICALLY EXCLUDED. IF, UNDER APPLICABLE STATE LAW, IMPLIED WARRANTIES MAY NOT VALIDLY BE DISCLAIMED OR EXCLUDED, THE DURATION OF SUCH IMPLIED WARRANTIES IS LIMITED TO THE PERIOD(S) FROM THE DATE OF PURCHASE SET FORTH BELOW. THIS WARRANTY GIVES YOU SPECIFIC LEGAL RIGHTS. YOU MAY ALSO HAVE OTHER RIGHTS WHICH VARY FROM STATE TO STATE.

The warranties given herein shall be the sole and exclusive warranties granted by Sharp and shall be the sole and exclusive remedy available to the purchaser and only for the time periods set forth herein. No other representations or promises made by anyone are permitted. Correction of defects, in the manner and for the period of time described herein, shall constitute complete fulfillment of all liabilities and responsibilities of Sharp to the purchaser with respect to the Product, and shall constitute full satisfaction of all claims, whether based on contract, negligence, strict liability or otherwise. Sharp does not warrant nor shall Sharp be liable, or in any way responsible, for Products which have been subject to abuse (including, but not limited to, improper voltage), accident, misuse, negligence, lack of reasonable care, alteration, modification, tampering, misuse, improper operation or maintenance or any damages or defects in the Product which were caused by repairs or attempted repairs performed by anyone other than a Sharp authorized servicer. Nor shall Sharp be liable or in any way responsible for any incidental or consequential economic or property damage. Some states do not allow limits on warranties or on remedies for breach in certain transactions; in such states, the limits herein may not apply.

**THIS LIMITED WARRANTY IS VALID ONLY IN THE FIFTY (50) UNITED STATES, THE DISTRICT OF COLUMBIA AND PUERTO RICO.**

### Model Specific Section

#### Your Product Model Number & Description:

LC-22DV17U Combination Liquid Crystal Television And DVD/CD player  
(Be sure to have this information available when you need service for your Product.)

#### Warranty Period for this Product:

One (1) year parts and labor from the date of purchase.

#### Additional Exclusions from Warranty Coverage (if any):

Image Retention resulting from a fixed image being displayed for long periods of time is not covered by this Limited Warranty (see Operation Manual on how to prevent this).

#### Where to Obtain Service:

From a Sharp Authorized Servicer located in the United States. To find the location of the nearest Sharp Authorized Servicer, please call Sharp toll free at 1-800-BE-SHARP.

#### What to do to Obtain Service:

Ship prepaid or carry in your Product to a Sharp Authorized Servicer. Be sure to have proof of purchase available. If you ship the Product, be sure it is insured and packaged securely. Please use two persons to carry the Product, transport it in its original packaging, and ensure that the Product is covered to avoid scratches and damage. Sharp shall not be responsible for lost, stolen or misdirected mail or for damage to the product incurred during shipping.

TO OBTAIN PRODUCT INFORMATION OR PURCHASE ACCESSORIES AND EXTENDED WARRANTIES, CALL 1-800-BE-SHARP OR VISIT [www.sharpsusa.com](http://www.sharpsusa.com)



