

LC-26D40U

LC-32D40U

LIQUID CRYSTAL TELEVISION

ENGLISH

OPERATION MANUAL

- The illustrations and on-screen displays in this operation manual are for explanation purposes and may vary slightly from the actual operations.
- Menu items that are not selectable are grayed out.
- The examples used throughout this manual are based on the LC-32D40U model.

IMPORTANT:

To aid reporting in case of loss or theft, please record the TV's model and serial numbers in the space provided. The numbers are located at the rear of the TV.

Model No.:

Serial No.:

IMPORTANT INFORMATION

WARNING: TO REDUCE THE RISK OF FIRE OR ELECTRIC SHOCK, DO NOT EXPOSE THIS PRODUCT TO RAIN OR MOISTURE.



CAUTION

RISK OF ELECTRIC SHOCK
DO NOT OPEN



CAUTION: TO REDUCE THE RISK OF ELECTRIC SHOCK,
DO NOT REMOVE COVER (OR BACK).
NO USER-SERVICEABLE PARTS INSIDE.
REFER SERVICING TO QUALIFIED SERVICE
PERSONNEL.



The lightning flash with arrow-head symbol, within an equilateral triangle, is intended to alert the user to the presence of uninsulated "dangerous voltage" within the product's enclosure that may be of sufficient magnitude to constitute a risk of electric shock to persons.



The exclamation point within a triangle is intended to alert the user to the presence of important operating and maintenance (servicing) instructions in the literature accompanying the product.

IMPORTANT INFORMATION

CAUTION: TO PREVENT ELECTRIC SHOCK, MATCH WIDE BLADE OF PLUG TO WIDE SLOT, FULLY INSERT.

CAUTION:

DO NOT PLACE THIS PRODUCT ON AN UNSTABLE CART, STAND, TRIPOD, BRACKET, OR TABLE. THE PRODUCT MAY FALL CAUSING SERIOUS PERSONAL INJURY AND SERIOUS DAMAGE TO THE PRODUCT. USE ONLY WITH A CART, STAND, TRIPOD, BRACKET, OR TABLE RECOMMENDED BY THE MANUFACTURER OR SOLD WITH THE PRODUCT. FOLLOW THE MANUFACTURER'S INSTRUCTIONS WHEN INSTALLING THE PRODUCT AND USE MOUNTING ACCESSORIES RECOMMENDED BY THE MANUFACTURER. A PRODUCT AND CART COMBINATION SHOULD BE MOVED WITH CARE. QUICK STOPS, EXCESSIVE FORCE, AND UNEVEN SURFACES MAY CAUSE THE PRODUCT AND CART COMBINATION TO OVERTURN.



WARNING: FCC Regulations state that any unauthorized changes or modifications to this equipment not expressly approved by the manufacturer could void the user's authority to operate this equipment.

CAUTION:

This product satisfies FCC regulations when shielded cables and connectors are used to connect the unit to other equipment. To prevent electromagnetic interference with electric appliances such as radios and televisions, use shielded cables and connectors for connections.

"Note to CATV system installer: This reminder is provided to call the CATV system installer's attention to Article 820-40 of the National Electrical Code that provides guidelines for proper grounding and, in particular, specifies that the cable ground shall be connected to the grounding system of the building, as close to the point of cable entry as practical."

This product utilizes tin-lead solder, and fluorescent lamp containing a small amount of mercury. Disposal of these materials may be regulated due to environmental considerations. For disposal or recycling information, please contact your local authorities or the Electronic Industries Alliance: www.eia.org

Trademarks

- Manufactured under license from Dolby Laboratories. "Dolby" and the double-D symbol are trademarks of Dolby Laboratories.

- "HDMI, the HDMI logo and High-Definition Multimedia Interface are trademarks or registered trademarks of HDMI Licensing LLC."

- WOW, SRS and  symbol are trademarks of SRS Labs, Inc. WOW technology is incorporated under license from SRS Labs, Inc.

DEAR SHARP CUSTOMER

Thank you for your purchase of the Sharp Liquid Crystal Television. To ensure safety and many years of trouble-free operation of your product, please read the Important Safety Instructions carefully before using this product.

IMPORTANT SAFETY INSTRUCTIONS

Electricity is used to perform many useful functions, but it can also cause personal injuries and property damage if improperly handled. This product has been engineered and manufactured with the highest priority on safety. However, improper use can result in electric shock and/or fire. In order to prevent potential danger, please observe the following instructions when installing, operating and cleaning the product. To ensure your safety and prolong the service life of your Liquid Crystal Television, please read the following precautions carefully before using the product.

- 1) Read these instructions.
- 2) Keep these instructions.
- 3) Heed all warnings.
- 4) Follow all instructions.
- 5) Do not use this apparatus near water.
- 6) Clean only with dry cloth.
- 7) Do not block any ventilation openings. Install in accordance with the manufacturer's instructions.
- 8) Do not install near any heat sources such as radiators, heat registers, stoves, or other apparatus (including amplifiers) that produce heat.
- 9) Do not defeat the safety purpose of the polarized or grounding-type plug. A polarized plug has two blades with one wider than the other. A grounding type plug has two blades and a third grounding prong. The wide blade or the third prong are provided for your safety. If the provided plug does not fit into your outlet, consult an electrician for replacement of the obsolete outlet.
- 10) Protect the power cord from being walked on or pinched particularly at plugs, convenience receptacles, and the point where they exit from the apparatus.
- 11) Only use attachments/accessories specified by the manufacturer.
- 12) Use only with the cart, stand, tripod, bracket, or table specified by the manufacturer, or sold with the apparatus. When a cart is used, use caution when moving the cart/apparatus combination to avoid injury from tip-over.
- 13) Unplug this apparatus during lightning storms or when unused for long periods of time.
- 14) Refer all servicing to qualified service personnel. Servicing is required when the apparatus has been damaged in any way, such as power-supply cord or plug is damaged, liquid has been spilled or objects have fallen into the apparatus, the apparatus has been exposed to rain or moisture, does not operate normally, or has been dropped.



Additional Safety Information

- 15) Power Sources—This product should be operated only from the type of power source indicated on the marking label. If you are not sure of the type of power supply to your home, consult your product dealer or local power company. For products intended to operate from battery power, or other sources, refer to the operating instructions.
- 16) Overloading—Do not overload wall outlets, extension cords, or integral convenience receptacles as this can result in a risk of fire or electric shock.
- 17) Object and Liquid Entry—Never push objects of any kind into this product through openings as they may touch dangerous voltage points or short-out parts that could result in a fire or electric shock. Never spill liquid of any kind on the product.
- 18) Damage Requiring Service—Unplug this product from the wall outlet and refer servicing to qualified service personnel under the following conditions:
 - a) When the AC cord or plug is damaged,
 - b) If liquid has been spilled, or objects have fallen into the product,
 - c) If the product has been exposed to rain or water,
 - d) If the product does not operate normally by following the operating instructions.
Adjust only those controls that are covered by the operating instructions as an improper adjustment of other controls may result in damage and will often require extensive work by a qualified technician to restore the product to its normal operation,
 - e) If the product has been dropped or damaged in any way, and
 - f) When the product exhibits a distinct change in performance - this indicates a need for service.
- 19) Replacement Parts—When replacement parts are required, be sure the service technician has used replacement parts specified by the manufacturer or have the same characteristics as the original part. Unauthorized substitutions may result in fire, electric shock, or other hazards.
- 20) Safety Check—Upon completion of any service or repairs to this product, ask the service technician to perform safety checks to determine that the product is in proper operating condition.
- 21) Wall or ceiling mounting—When mounting the product on a wall or ceiling, be sure to install the product according to the method recommended by the manufacturer.

IMPORTANT SAFETY INSTRUCTIONS

- **Water and Moisture** — Do not use this product near water - for example, near a bath tub, wash bowl, kitchen sink, or laundry tub; in a wet basement; or near a swimming pool; and the like.



- **Stand** — Do not place the product on an unstable cart, stand, tripod or table. Placing the product on an unstable base can cause the product to fall, resulting in serious personal injuries as well as damage to the product. Use only a cart, stand, tripod, bracket or table recommended by the manufacturer or sold with the product. When mounting the product on a wall, be sure to follow the manufacturer's instructions. Use only the mounting hardware recommended by the manufacturer.



- **Selecting the location** — Select a place with no direct sunlight and good ventilation.



- **Ventilation** — The vents and other openings in the cabinet are designed for ventilation. Do not cover or block these vents and openings since insufficient ventilation can cause overheating and/or shorten the life of the product. Do not place the product on a bed, sofa, rug or other similar surface, since they can block ventilation openings. This product is not designed for built-in installation; do not place the product in an enclosed place such as a bookcase or rack, unless proper ventilation is provided or the manufacturer's instructions are followed.



- **The Liquid Crystal panel** used in this product is made of glass. Therefore, it can break when the product is dropped or applied with impact. Be careful not to be injured by broken glass pieces in case the panel breaks.



- **Heat** — The product should be situated away from heat sources such as radiators, heat registers, stoves, or other products (including amplifiers) that produce heat.



- The Liquid Crystal panel is a very high technology product with 3,147,264 thin film transistors, giving you fine picture details. Occasionally, a few non-active pixels may appear on the screen as a fixed point of blue, green or red. Please note that this does not affect the performance of your product.

Precautions when transporting the TV

- When transporting the TV, never carry it by holding onto the speaker. Be sure to always carry the TV by two people holding it with two hands — one hand on each side of the TV.

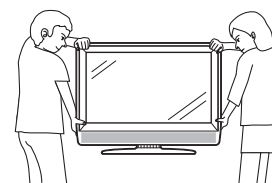

- **Lightning** — For added protection for this television equipment during a lightning storm, or when it is left unattended and unused for long periods of time, unplug it from the wall outlet and disconnect the antenna. This will prevent damage to the equipment due to lightning and power-line surges.

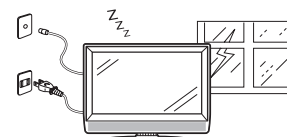

- **Power Lines** — An outside antenna system should not be located in the vicinity of overhead power lines or other electric light or power circuits, or where it can fall into such power lines or circuits. When installing an outside antenna system, extreme care should be taken to keep from touching such power lines or circuits as contact with them might be fatal.

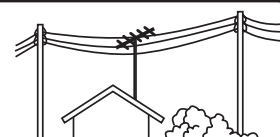

IMPORTANT SAFETY INSTRUCTIONS

- Outdoor Antenna Grounding — If an outside antenna is connected to the television equipment, be sure the antenna system is grounded so as to provide some protection against voltage surges and built-up static charges. Article 810 of the National Electrical Code, ANSI/NFPA 70, provides information with regard to proper grounding of the mast and supporting structure, grounding of the lead-in wire to an antenna discharge unit, size of grounding conductors, location of antenna-discharge unit, connection to grounding electrodes, and requirements for the grounding electrode.

EXAMPLE OF ANTENNA GROUNDING AS PER NATIONAL ELECTRICAL CODE, ANSI/NFPA 70

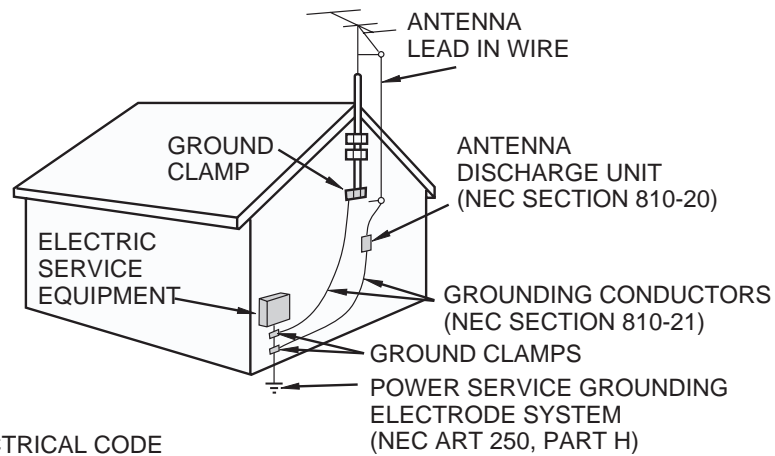

NEC — NATIONAL ELECTRICAL CODE

- To prevent fire, never place any type of candle or flames on the top or near the TV set.

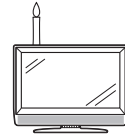

- To prevent fire or shock hazard, do not expose this product to dripping or splashing. No objects filled with liquids, such as vases, should be placed on the product.



- To prevent fire or shock hazard, do not place the AC cord under the TV set or other heavy items.

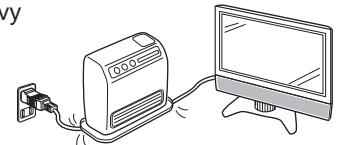



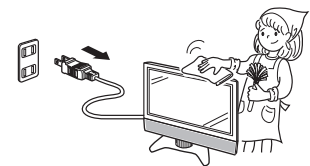

- Turn off the main power and unplug the AC cord from the wall outlet before handling.
- Use a soft cloth and gently wipe the surface of the display panel. Using a hard cloth may scratch the panel surface.
- Use a soft damp cloth to gently wipe the panel when it is really dirty. (It may scratch the panel surface when wiped strongly.)
- If the panel is dusty, use an anti-static brush, which is commercially available, to clean it.
- To protect the panel, do not use a dirty cloth, liquid cleaners or chemical cloth to clean it, such materials may damage the panel surface.

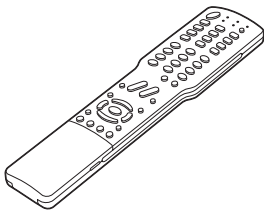

- Do not display a still picture for a long time, as this could cause an afterimage to remain.

Supplied accessories

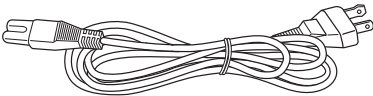
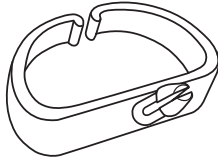
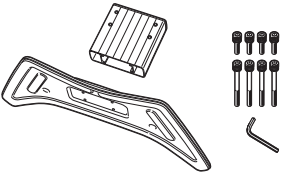
Make sure the following accessories are provided with the product.

Remote control unit (X1)	"AAA" size battery (X2)	AC cord (X1)
 Page 8	 Page 8	 Page 7
Cable Clamp (X1)	Stand unit (X1)	Operation manual (X1)
 Page 7	 Page 6	

NOTE

- Always use the AC cord supplied with the TV.

QUICK REFERENCE

Attaching the stand

- Before attaching (or detaching) stand, unplug the AC cord from the AC input terminal.
- Before performing work spread cushioning over the base area to lay the TV on. This will prevent it from being damaged.

1. Confirm the 8 screws supplied with the TV.

Short screws (X4)
(used in step 2)



Long screws (X4)
(used in step 4)

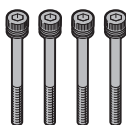

2. Attach the two parts of the stand unit to each other using the 4 short screws and the hex key (supplied with the product) as shown.

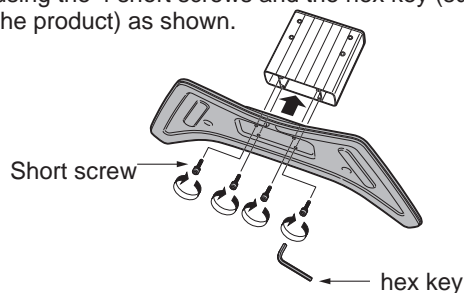

3. Insert the stand into the opening on the bottom of the TV.

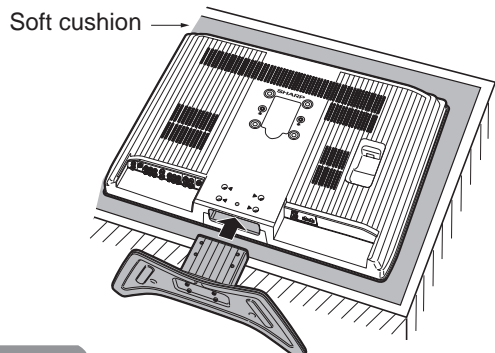

4. Insert and tighten the 4 long screws into the 4 holes on the rear of the TV.

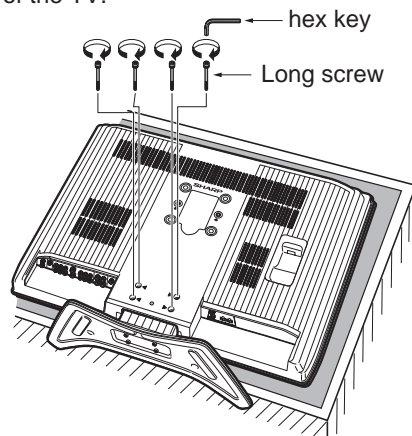

NOTE

- To detach the stand, perform the steps in reverse order.

QUICK REFERENCE

STOP! To safely remove the AQUOS television from the box

It's best to use 2 people to remove the AQUOS television for stability.

1. Use the cardboard holders on either side of the AQUOS television to remove it from the box.
2. Remove the cardboard; however, keep the wrapping on the AQUOS television to protect it while moving.
3. Lift onto installation location as the diagram illustrates.

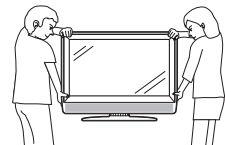

Ventilation & Cleaning Tips

Keep your AQUOS television in a well ventilated area and make sure not to place it by a heat source or use near water. The AQUOS television is designed for AC use only and should be used with supplied AC cord.

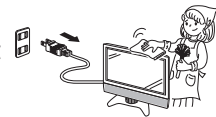

Clean the screen by spraying a soft lint free cloth with water to lightly moisten. Gently wipe and avoid pressing on the screen. To clean the outer cabinet, use the same method. Do not use liquid or aerosol cleaners.



The screen is glass and can be scratched or broken when dropped or impacted.

QUICK INSTALLATION TIPS

1. Attach your antenna to the back of the TV.
(See page 13.)
2. Connect the AC plug for the AQUOS television into the wall outlet.

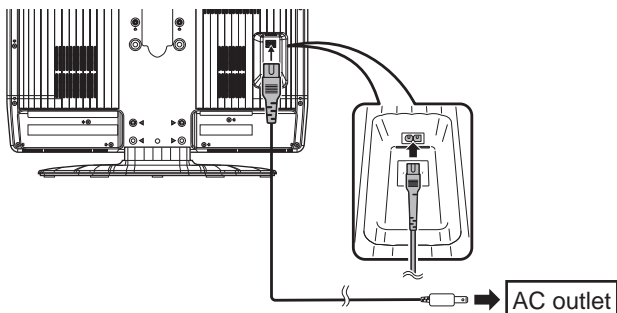

- Place the TV close to the AC outlet, and keep the power plug within reach.

NOTE

- **TO PREVENT RISK OF ELECTRIC SHOCK, DO NOT TOUCH UN-INSULATED PARTS OF ANY CABLES WITH THE AC CORD CONNECTED.**

3. Bundle the cords properly with a cable clamp and cable tie.

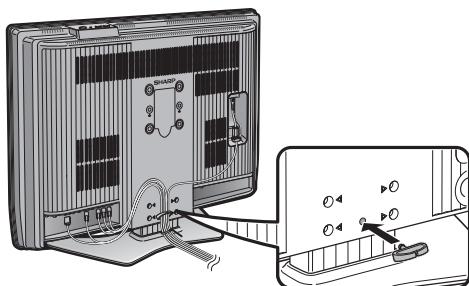

4. How to turn on the AQUOS television for the first time.
 - A) Press **POWER** on AQUOS television.

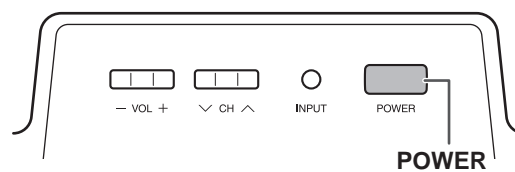

- B) **POWER** indicator on the front of the AQUOS television lights GREEN.

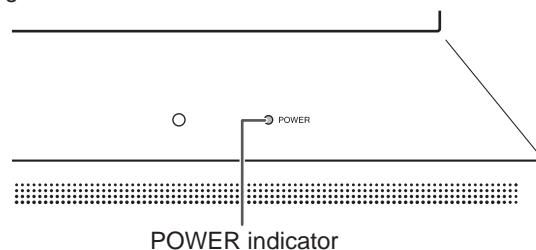

NOTE

- Speaker cannot be detached from the TV.
- TV angle cannot be adjusted.

QUICK REFERENCE

If the remote control fails to operate TV functions, replace the batteries in the remote control unit.

1 Open the battery cover.

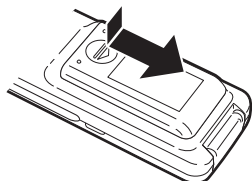

2 Insert two "AAA" size batteries (supplied with the product).

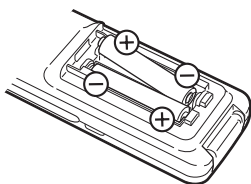

3 Close the battery cover.

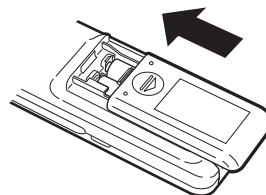

- Place the batteries with their terminals corresponding to the (+) and (-) indications in the battery compartment.

NOTE

Improper use of batteries can result in chemical leakage or explosion. Be sure to follow the instructions below.

- Do not mix batteries of different types. Different types of batteries have different characteristics.
- Do not mix old and new batteries. Mixing old and new batteries can shorten the life of new batteries or cause chemical leakage in old batteries.
- Remove batteries as soon as they are worn out. Chemicals that leak from batteries that come in contact with skin can cause a rash. If you find any chemical leakage, wipe thoroughly with a cloth.
- The batteries supplied with this product may have a shorter life expectancy due to storage conditions.
- If you will not be using the remote control unit for an extended period of time, remove batteries from it.

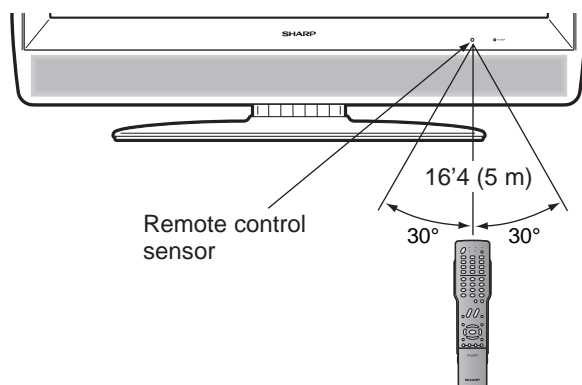

IMPORTANT:

The POWER indicator on the AQUOS television should light GREEN indicating you have power to the AQUOS television.

If the POWER indicator on the AQUOS television still does not light up, press **TV POWER** on the remote control to turn the power on.

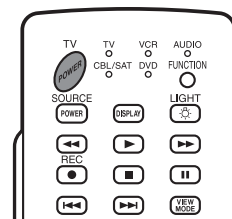

IMPORTANT:

IF THE UNIT DOES NOT POWER ON - UNPLUG THE AQUOS TELEVISION FROM THE OUTLET AND REPEAT THE INSTALLATION STEPS.

IF YOU STILL ENCOUNTER NO POWER, PLEASE CONTACT US AT 1-800-BE-SHARP.

Please refer to the BASIC ADJUSTMENT SETTINGS SECTION and basic Initial setup functions and USING EXTERNAL EQUIPMENT SECTION for other device connections (DVD, VCR, AUDIO, etc) in your AQUOS operation manual.

Contents

IMPORTANT INFORMATION	1	Using external equipment	23
Trademarks	2	Displaying an external equipment image	23
DEAR SHARP CUSTOMER	3	Connecting a DVD player or a digital TV STB (Air or Cable)	24
IMPORTANT SAFETY INSTRUCTIONS	3	Connecting a VCR, game console or camcorder	24
Supplied accessories	6	Using digital audio output	24
QUICK REFERENCE	6	Connecting HDMI equipment	25
Attaching the stand.....	6	Displaying an image from HDMI equipment.....	25
Contents	9	Selecting HDMI audio input source	25
Part names	10	Useful adjustment settings	26
TV (Front)	10	Reset	26
TV (Rear).....	11	Input label.....	26
Remote control unit	12	AV mode.....	27
Preparation	13	Selecting the digital audio language.....	27
Using the remote control unit	13	View mode for 4:3 programs	28
Cautions regarding remote control unit	13	View mode for HD programs	28
Antennas	13	Picture scroll.....	28
Watching TV	14	Aspect	28
Preparation.....	14	Audio output select.....	29
Turning on the power	14	Sleep timer	29
Turning off the power	14	Closed captions and digital closed captions.....	30
Initial setup	14	Caption setup	31
Simple button operations for changing channels	16	Password setting for parental control	32
Simple button operations for changing volume/sound	17	Parental control (V-CHIP).....	33
Display the channel information	17	TV Parental Guide lines (TV Guide lines)	34
Setting MTS/SAP stereo mode	18	Voluntary movie rating system (MPAA).....	34
Setting WOW™ surround sound.....	18	How to temporarily release the V-CHIP block.....	34
Basic adjustment settings	19	Reactivating the temporarily released V-CHIP block.....	34
Menu operation buttons.....	19	Other viewing options	35
Menu items.....	19	Freezing images.....	35
Favorite channel setting	20	Signal meter	35
Labeling channels	20	Presetting remote control function.....	35
Picture adjustments.....	21	Appendix	39
Back lighting	21	Removing the stand	39
Color temperature	21	Setting the TV on the wall	39
Cinema mode	21	Troubleshooting.....	40
Sound adjustment	22	Troubleshooting-Digital broadcasting.....	40
Digital audio output.....	22	Specifications	41
		Dimensional drawings	42

Part names

TV (Front)

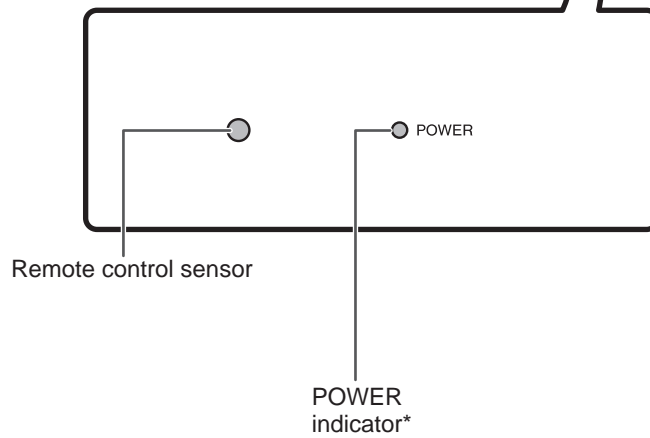
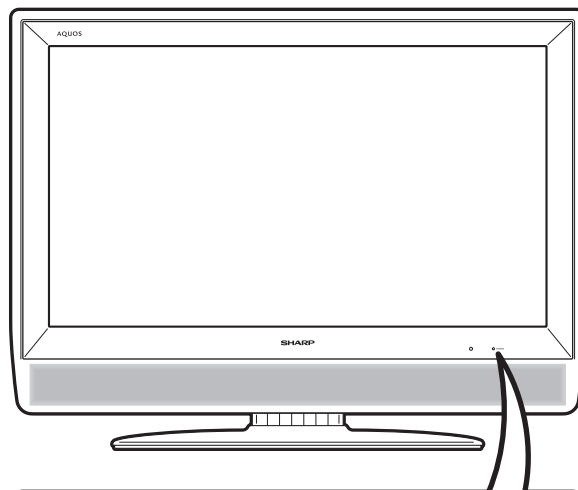
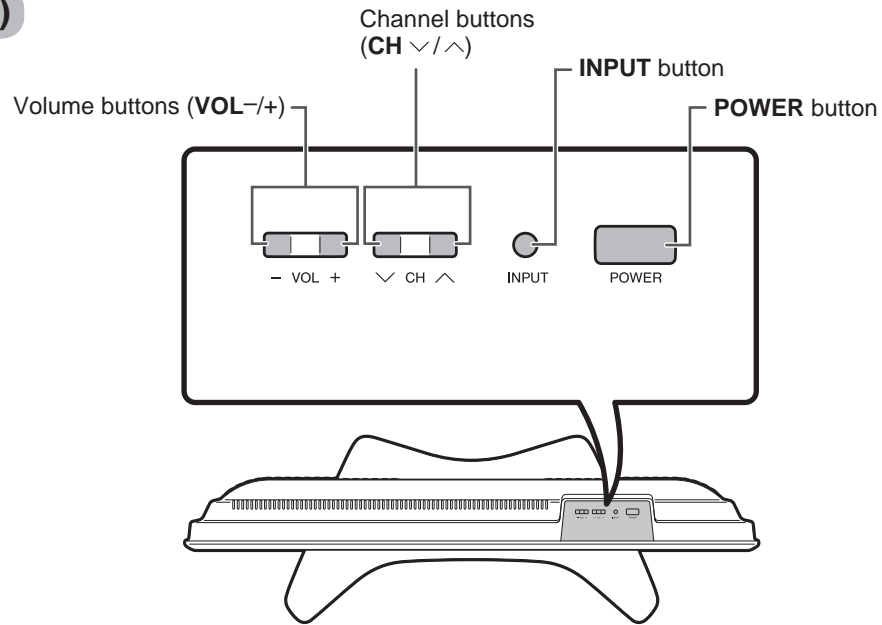

NOTE

*See page 14 for TV status indicator.

Part names

TV (Rear)

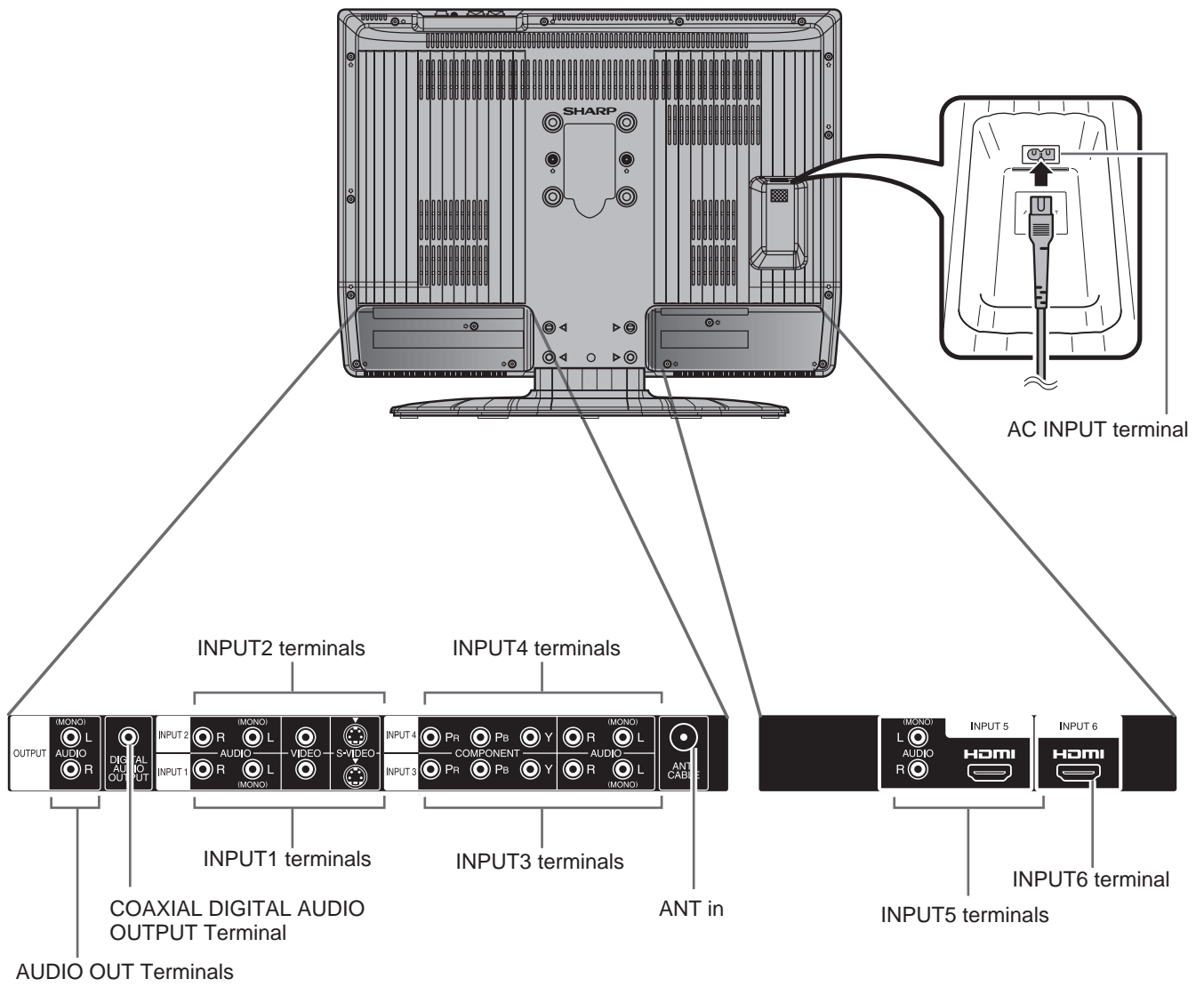

Remote control unit

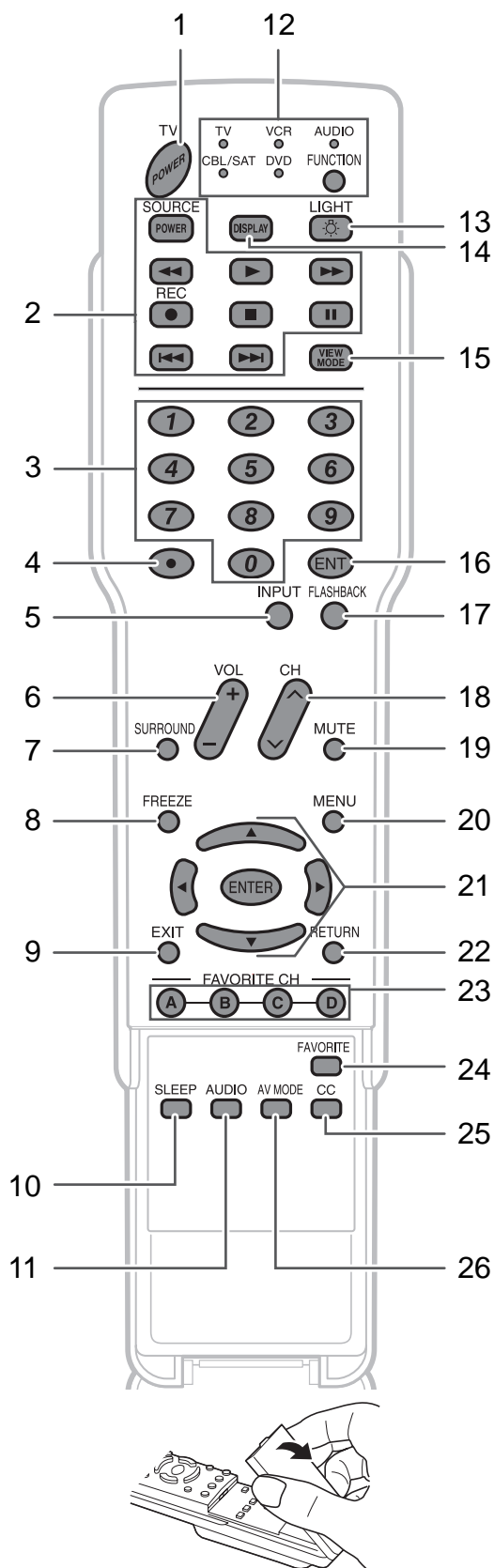

- 1 **TV POWER:** Switch the TV power on or enters standby mode. (See page 14.)
- 2 **External equipment operational buttons:** Operate the external equipment.
- 3 **0 – 9:** Set the channel. (See page 16.)
- 4 **• (DOT):** (See page 16.)
- 5 **INPUT:** Select a TV input source. (TV, INPUT1~6) (See page 23.)
- 6 **VOL +/-:** Set the volume. (See page 17.)
- 7 **SURROUND:** Display the WOW surround setting menu. (See page 18.)
- 8 **FREEZE:** Set the still image. Press again to return to normal screen. (See page 35.)
- 9 **EXIT:** Turn off the menu screen.
- 10 **SLEEP:** Set the sleep timer. (See page 29.)
- 11 **AUDIO:** Display the MTS setting menu. (See page 18.)
- 12 **FUNCTION:** Switches the remote control for TV, CBL/SAT, VCR, DVD and AUDIO operation. Indicator lights up for the current mode. (See pages 35, 37 and 38 for details.)
 * To enter the code registration mode, you need to press **FUNCTION** and **DISPLAY** at the same time.
- 13 **LIGHT** : When pressed all buttons without **SLEEP**, **AUDIO**, **FAVORITE**, **CC** and **AV MODE** on the remote control unit will light. The lighting will turn off if no operations are performed within about 5 seconds. This button is used for performing operations in low-light situations.
- 14 **DISPLAY:** Display the channel information.
- 15 **VIEW MODE:** Select the screen size. (See page 28.)
- 16 **ENT:** Jumps to a channel after selecting with the **0–9** buttons.
- 17 **FLASHBACK:** Return to the previous channel or input external mode. (See page 16.)
- 18 **CH ^ / v:** Select the channel. (See page 16.)
- 19 **MUTE:** Mute the sound. (See page 17.)
- 20 **MENU:** Display the menu screen.
- 21 **▲/▼/◀/▶/ENTER:** Select a desired item on the screen.
- 22 **RETURN:** Return to the previous menu screen.
- 23 **FAVORITE CH**
A, B, C, D: Select four preset favorite channels in four different categories. (See page 20 for details.)
 While watching, you can toggle the selected channels by pressing A, B, C and D.
- 24 **FAVORITE:** Display the Favorite channel menu. (See page 20.)
- 25 **CC:** Display captions during closed-caption source. (See page 30.)
- 26 **AV MODE:** Select an adjusted picture setting. (SPORTS, STANDARD, MOVIE, MEMORY.) (See page 27.)

NOTE

- When using the remote control unit, point it at the TV. (See page 8.)

Preparation

Using the remote control unit

Use the remote control unit by pointing it towards the remote control sensor on the TV. Objects between the remote control unit and the remote control sensor may prevent proper operation.

Cautions regarding remote control unit

- Do not expose the remote control unit to shock. In addition, do not expose the remote control unit to liquids, and do not place in an area with high humidity.
- Do not install or place the remote control unit under direct sunlight. The heat may cause deformation of the remote control unit.
- The remote control unit may not work properly if the remote control sensor on the TV is under direct sunlight or strong lighting. In such cases, change the angle of the lighting or the TV, or operate the remote control unit closer to the remote control sensor.

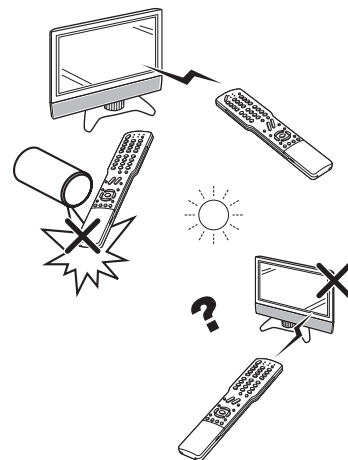

Antennas

To enjoy a clearer picture, use an outdoor antenna. The following is a brief explanation of the types of connections that are used for a coaxial cable. If your outdoor antenna uses a 75-ohm coaxial cable with an F-type connector, plug it into the antenna terminal at the rear of the TV set.

1. A 75-ohm system is generally a round cable with F-type connector that can easily be attached to a terminal without tools (Commercially available).

2. A 300-ohm system is a flat "twin-lead" cable that can be attached to a 75-ohm terminal through a 300/75-ohm adapter (Commercially available).

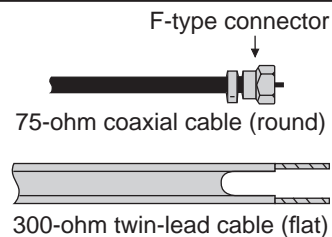

NOTICE

F-type connector

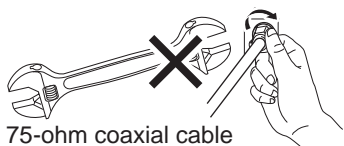

75-ohm coaxial cable

F-type connector should be finger-tightened only.

When connecting the RF cable to the TV set, do not tighten F-type connector with tools.

If tools are used, it may cause damage to your TV set. (The breaking of internal circuit, etc.)

Connecting Antenna Cable

Cable without a CATV converter
Combination VHF/UHF antenna

Separate VHF/UHF antenna

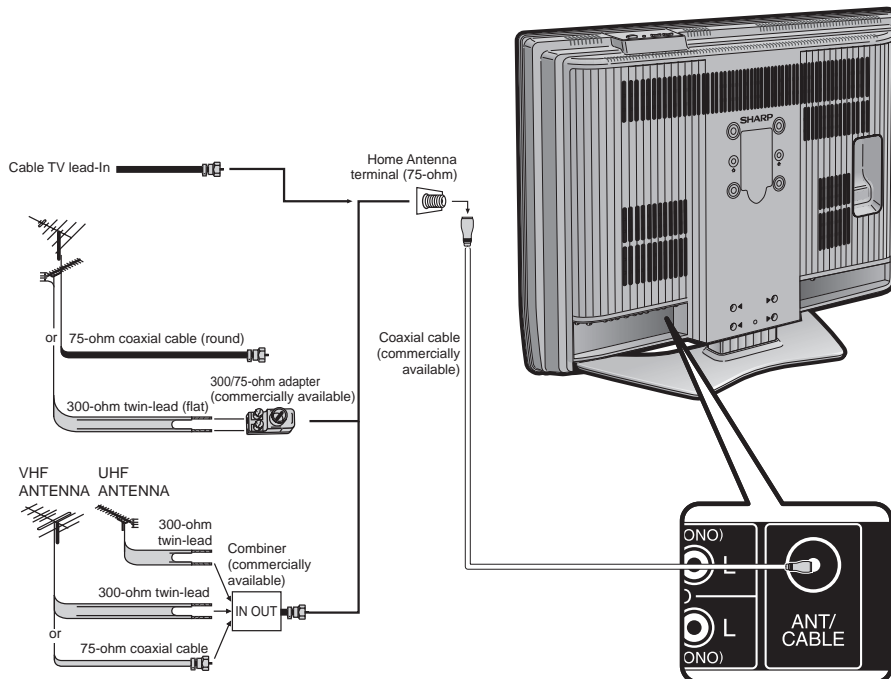

Watching TV

Simple operations for watching a TV program

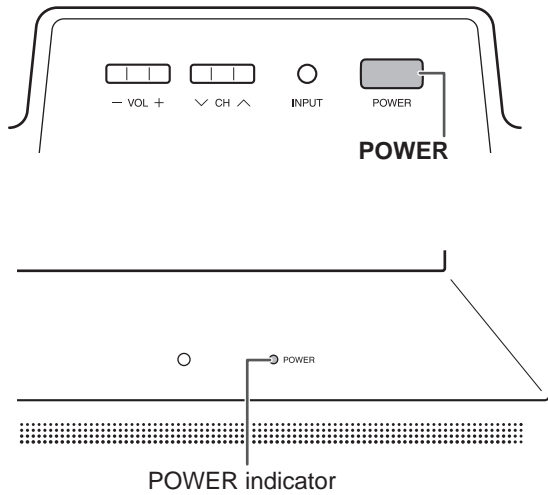

TV status indicator (POWER)

ON	Lighting (Green)
OFF/Standby	Lighting (Red)

TV POWER (On/Standby)

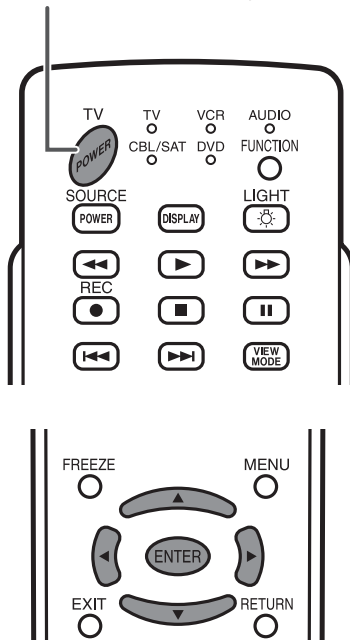

Preparation

Perform the following steps before you press **TV POWER** on the remote control unit.

1. Insert the batteries into the remote control unit. (See page 8.)
2. Connect the antenna cable to the TV. (See page 13.)
3. Plug in the AC cord to the AC outlet. (See page 7.)

Turning on the power

Press **POWER** on the TV, or **TV POWER** on the remote control.

- **POWER indicator (Green):** The TV is on. ("PLEASE WAIT" will appear for a few seconds on the screen.)

NOTE

- The **LANGUAGE** setup menu will appear automatically when **MENU** is pressed for the first time. (See below.)

Turning off the power

Press **POWER** on the TV, or **TV POWER** on the remote control.

- The TV enters standby mode and the image on the screen disappears.
- The **POWER** indicator on the TV changes to Red.

NOTE

- If you are not going to use this TV for a long period of time, be sure to remove the AC cord from the power outlet.
- Weak electric power is still consumed even when **POWER** is turned off.
- If a station being viewed stops broadcasting, the TV will automatically shut itself off after 15 minutes.

Initial setup

Language setting

When you press **MENU** for the first time, the **LANGUAGE** setup menu will appear automatically.

Select from among 3 languages: English, French and Spanish.

1

Press **◀/▶** to select the desired language from the list.

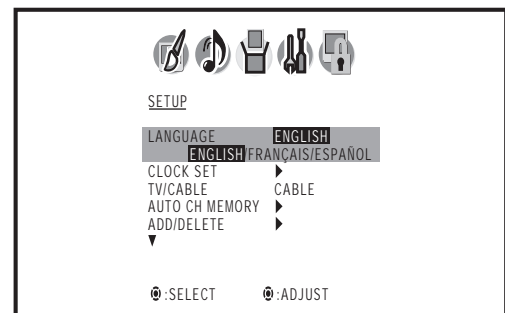

Watching TV

Clock setting

Please set correct date and time manually.

2

Press ▲/▼ to select "CLOCK SET", then press ◀/▶. The CLOCK SET menu screen displays.

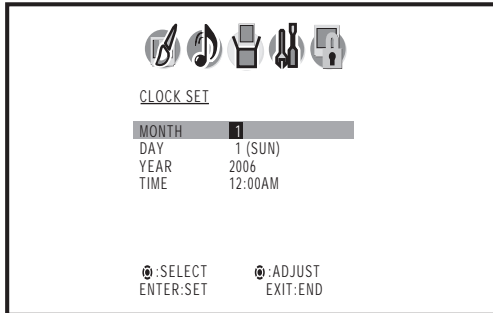

Press ◀/▶ to set the MONTH, then press ▼ to move to the next.

Set the DAY, YEAR and TIME (hour and minute) as above step.

After setting the date and time correctly, press **ENTER**.

Antenna setting

Make sure what kind of connection is made with your TV when selecting "TV" or "CABLE".

3

Press ▲/▼ to select "TV/CABLE", then press ◀/▶ to select "TV" or "CABLE".

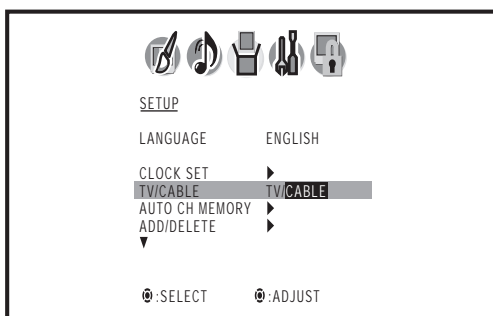

Channel search

AUTO CHANNEL MEMORY makes the TV look for all channels viewable in the set area.

4

Press ▲/▼ to select "AUTO CH MEMORY"

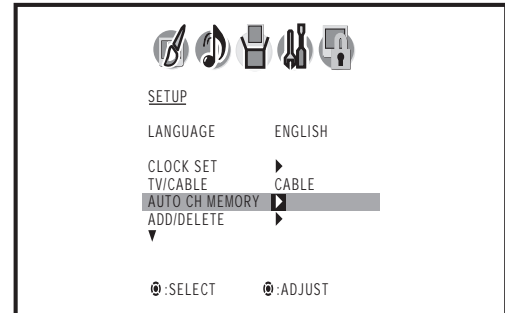

Press ◀/▶. The TV will begin memorizing all the channels available in your area.

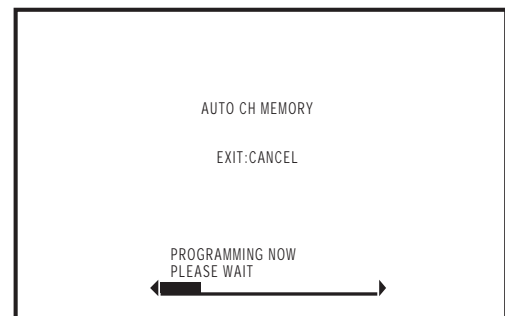

- Depending on the reception condition, it may take approximately 10 minutes to complete memorizing digital cable channels, please be patient.

Skipping stored channel

You can set channel selection disabled using **CH** ^ / v.

1

Press **MENU** and the MENU screen displays.

2

Press ◀/▶ to select  (SETUP).

3

Press ▲/▼ to select "ADD/DELETE", and then press ◀/▶.

4

Press ▲/▼ to select "ADD/DELETE", and then press ◀/▶. Now, the channel list becomes selectable.

5

Press ▲/▼ to select the channel which you want to skip.

6

Press ◀/▶ to select "DELETE" for selected channel.

7

Press **EXIT** to return to the normal screen. Now, skipping channel is applied.

- **To release the skipping channel:**
Select "ADD" in step 6.
- **To remove all the channels from channel memory:**
Select "CLEAR ALL" after step 3, and the press ◀/▶.

Simple button operations for changing channels

You can change channels in several ways.

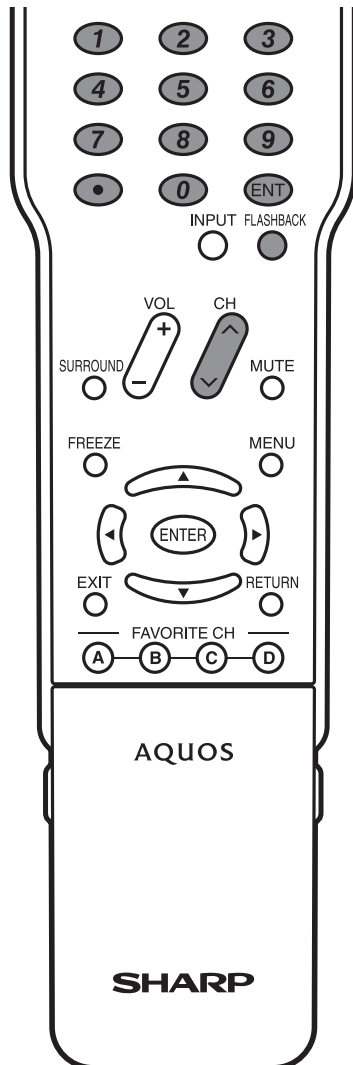

Method 1

Using CH \wedge / \vee on the remote control unit or on the TV.

Method 2

- 1 Press **FLASHBACK** to switch to the previously tuned channel.
- 2 Press **FLASHBACK** again to switch back to the currently tuned channel.

NOTE

- **FLASHBACK** will not work if no channel has been changed after the TV is turned on.

Method 3

Using remote control buttons **0-9**, • (DOT) to select channels for VHF/UHF/CATV/DIGITAL.

To select a 1 or 2-digit channel number (e. g., Channel 5):

Press **5** → **ENT**

NOTE

- When selecting a 1-digit channel number, it is not necessary to press **0** before the number.
- When you enter **0-9** only, channel selection will be made if there is no operation within a few seconds.

To select a 3-digit channel number (e. g., Channel 115):

Press **1** → **1** → **5** → **ENT**

To select a 4-digit channel number (e. g., Channel 22.1):

Press **2** → **2** → • (DOT) → **1** → **ENT**

NOTE

- When you enter **0-9** only, channel selection will be made if there is no operation within a few seconds.
- If you push "0" by itself, nothing will happen.
- Complete the above steps within a few seconds.
- When you enter **0-9** and • (DOT), channel selection will be made if there is no operation within a few seconds.

Watching TV

Simple button operations for changing volume/sound

Changing the volume

You can change the volume on the TV or on the remote control unit.

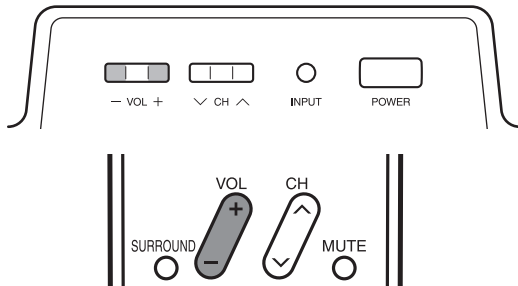

Using VOL +/-

- To increase the volume, press **VOL+**.
- To decrease the volume, press **VOL-**.



NOTE

- **VOL+/-** on the TV operates the same as **VOL+/-** on the remote control unit.

Using MUTE on the remote control unit

Mutes the current sound output.

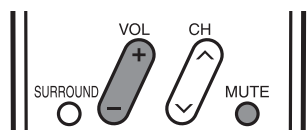

1

Press **MUTE**.

- "MUTE" will be displayed on the screen, and the sound is silenced.



NOTE

- Mute can be canceled if you press **VOL+/-** or **MUTE**.

Display the channel information

Press **DISPLAY** to display the current channel (or input source) information on the screen.

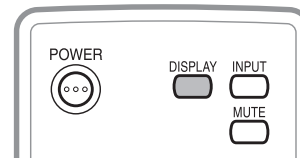

When the TV receives a digital signal, press once, the digital information will appear.

- Broadcast program name
- Station name
- Audio language
- V-CHIP RATING
- Closed Caption mark
- Remaining time
- Program name
- HD or SD mark
- V-Chip mark

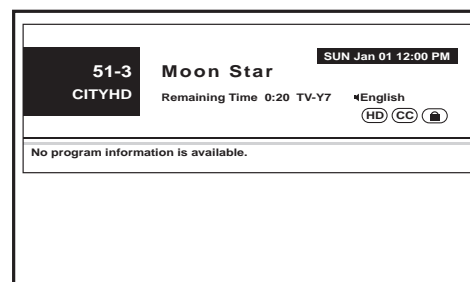

Press **DISPLAY** again, the analog information will appear.

- Clock
- Channel number or VIDEO mode selected
- Channel label (if preset)
- Stereo or SAP (second audio program) audio status
- Content rating
- View mode

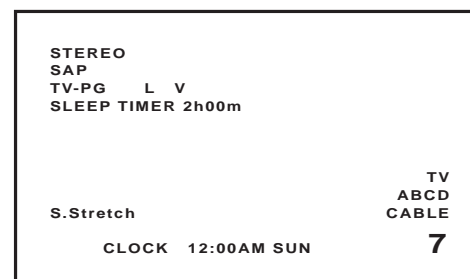

Press **DISPLAY** again to clear the display.

Watching TV

Setting MTS/SAP stereo mode

The TV has a feature that allows reception of sound other than the main audio for the program. This feature is called Multi-channel Television Sound (MTS). The TV with MTS can receive mono sound, stereo sound and Secondary Audio Programs (SAP). The SAP feature allows a TV station to broadcast other information, which could be audio in another language or something completely different like weather information.

You can enjoy Hi-Fi stereo sound or SAP broadcasts where available.

• Stereo broadcasts

View programs like live sporting events, shows and concerts in dynamic stereo sound.

• SAP broadcasts

Receive TV broadcasts in either MAIN or SAP sound. MAIN sound: The normal program soundtrack (either in mono or stereo).

SAP sound: Listen to a second language, supplementary commentary or other information. (SAP is mono sound.)

If stereo sound is difficult to hear.

- Obtain a clearer sound by manually switching to fixed mono-sound mode.

NOTE

- MTS only operates while in TV mode.
- When the TV receives a stereo or SAP broadcast, the word "STEREO" or "SAP" displays on-screen every time you turn the TV on, change the channel, or press **DISPLAY**.

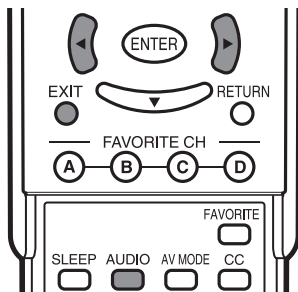

Changing MTS

You can change MTS as shown below to match the television broadcast signal.

- 1 Press **AUDIO** and the (AUDIO) menu screen displays. "MTS" will be highlighted.

- 2 Press **AUDIO** again or to select "STR (STEREO)", "SAP" or "MONO".

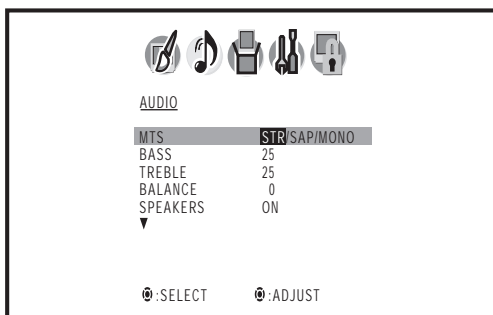

- 3 Press **EXIT** to return to the normal screen.

Setting WOW™ surround sound

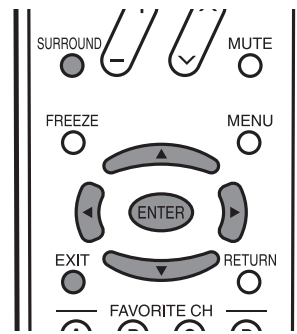

WOW is a special combination of SRS Labs audio technologies that creates a thrilling surround sound experience with deep, rich bass from stereo sound sources. Your TV's audio will sound fuller, richer, and wider. WOW consists of three features; SRS 3D, FOCUS, and TruBass.

- 1 Select **STEREO** mode (see "Setting MTS/SAP stereo mode" on this page).
- 2 Press **SURROUND** and the (AUDIO) menu screen displays. "WOW SRS 3D" will be highlighted.
- 3 Press to select the desired WOW feature you want to adjust.

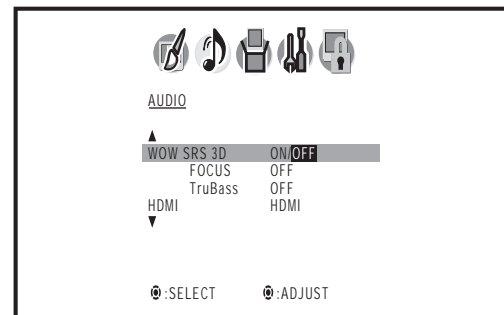

SRS 3D: Press to turn on or off the surround sound effect.

FOCUS: Press to turn on or off the vocal emphasis effect.

TruBass: Press to select the bass expansion effect high, low or off.

- 4 After your desired setting, press **EXIT** to return to the normal screen.

NOTE

- You can enter to the same menu screen from (AUDIO) menu.

Basic adjustment settings

Menu operation buttons

Use the following buttons on the remote control to operate the menu.

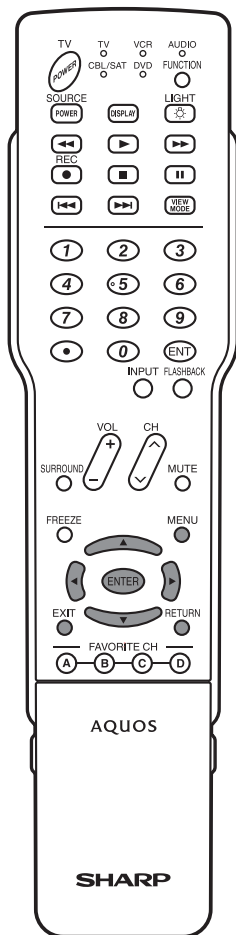

- MENU:** Press to open the menu screen.
- ▲/▼/◀/▶:** Press to select a desired item on the screen or adjust a selected item.
- ENTER:** Press to go to the next step or complete the setting.
- RETURN:** Press to return to the previous step.
- EXIT:** Press to exit from the menu screen. All changed settings will be saved.

⊙:SELECT
ENTER:SET

⊙:ADJUST
EXIT:END

The lower part of the menu screen is an operational guide for the remote control. It will change in accordance with each menu setting screen.

Menu items

List of menu items to help you with operations

PICTURE

AV MODE	Page 27
BRIGHTNESS	Page 21
CONTRAST	Page 21
COLOR	Page 21
TINT	Page 21
SHARPNESS	Page 21
COLOR TEMPERATURE	Page 21
RESET (Picture adjustments)	Page 26

AUDIO

MTS	Page 18
BASS	Page 22
TREBLE	Page 22
BALANCE	Page 22
SPEAKERS	Page 29
WOW	
SRS 3D	Page 18
FOCUS	Page 18
TruBass	Page 18
HDMI	Page 25
AUDIO LANGUAGE	Page 27
DIGITAL OUTPUT	Page 22
RESET (Sound adjustments)	Page 26

SETUP

LANGUAGE	Page 14
CLOCK SET	Page 15
TV/CABLE	Page 15
AUTO CH MEMORY	Page 15
ADD/DELETE	Page 15
CLOSED CAPTION	Page 30
CC ADVANCED	Page 31
VIEW MODE	Page 28
PICTURE SCROLL	Page 28
CINEMA MODE	Page 21
ASPECT	Page 28
SIGNAL METER	Page 35
BACK LIGHTING	Page 21

OPTION

FAVORITE CH	Page 20
CH LABEL	Page 20
VIDEO LABEL	Page 26

LOCKS

V-CHIP SET	Page 34
NEW PASSWORD	Page 32

Basic adjustment settings

Favorite channel setting

This function allows you to program 4 favorite channels. By setting the favorite channels in advance, you can select your favorite channels easily.

Programming favorite channel

- 1 Select the channel you want to register as a favorite channel.
- 2 Press **FAVORITE** and the FAVORITE CH menu screen displays.
- 3 Press **◀/▶** to select "SET", and then press **ENTER**.
- 4 Press **◀/▶** to select the position, and then press **ENTER** to register.

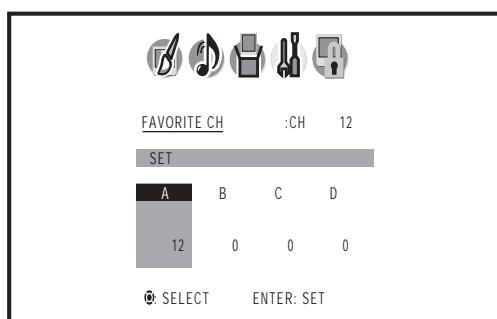

- 5 Press **EXIT** to return to the normal screen.

- 6 You can jump to the registered favorite channels directly using four **FAVORITE CH**.

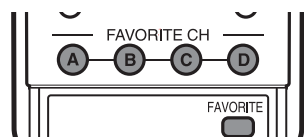

NOTE

- You can enter to the same menu screen from **(OPTION)** menu.

Deleting a favorite channel

- 1 Repeat steps 1 to 2 in above procedure.
- 2 Press **◀/▶** to select "CLEAR", and then press **ENTER**.
- 3 Press **◀/▶** to select the registered favorite channel you want to release, and then press **ENTER**.
- 4 Press **EXIT** to return to the normal screen.

Labeling channels

To create channel labels

- 1 Select a channel you want to label.
- 2 Press **MENU**, then press **◀/▶** to select **(OPTION)**. Press **▲/▼** to select "CH LABEL", then press **◀/▶**. The CH LABEL menu will appear.
- 3 Press **▲/▼** to select "SET/CLEAR". Press **◀/▶** to select "SET" then press **ENTER**.
- 4 Press **◀/▶** to enter a character in the first space. Press the button repeatedly until the character you want appears on the screen.

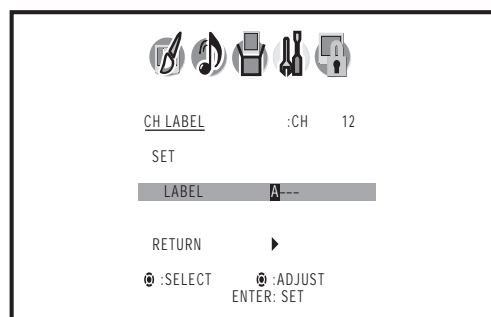

The characters rotation as follows:

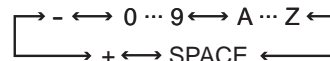

If the character which you desire appears, press **ENTER**. Repeat this step to enter the rest of the characters. When you finish inputting the label name, press **ENTER**.

- 5 Press **EXIT** to return to the normal screen.
- 6 Repeat steps 1-5 for other channels. You can assign a label to each channel.

To erase channel labels

- 1 Select a channel with a label which you want to remove.
- 2 Press **MENU**, then press **◀/▶** to select **(OPTION)**. Press **▲/▼** to select "CH LABEL", then press **◀/▶** to display the CH LABEL menu.
- 3 Press **▲/▼** to select "SET/CLEAR". Press **◀/▶** to select "CLEAR", then press **ENTER**.
- 4 Press **EXIT** to return to the normal screen.
- 5 Repeat steps 1-4 to erase other channel labels.

Basic adjustment settings

Picture adjustments

Adjusts the picture to your preference with the following picture settings.

- 1 Press **MENU** and the MENU screen displays.
- 2 Press ◀/▶ to select  (PICTURE).
- 3 Press ▲/▼ to select a specific adjustment item (BRIGHTNESS, CONTRAST, COLOR, TINT, SHARPNESS).
- 4 Press ◀/▶ to adjust the item to the desired level.

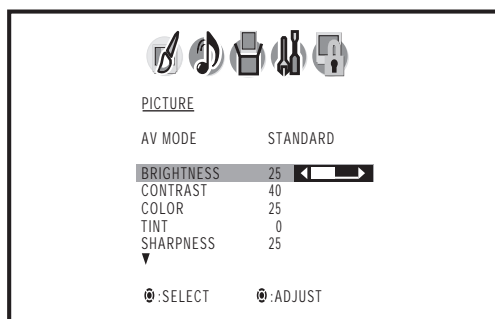

Selected item	◀ button	▶ button
BRIGHTNESS	For less brightness	For more brightness
CONTRAST	For less contrast	For more contrast
COLOR	For less color intensity	For more color intensity
TINT	Skin tones become purplish	Skin tones become greenish
SHARPNESS	For less sharpness	For more sharpness

- 5 Press **EXIT** to return to the normal screen.

NOTE

- For resetting all Picture adjustment items to the factory preset values, press ▲/▼ to select "RESET", and then press ◀/▶ (see page 26 for further information).

Back lighting

BACK LIGHTING adjusts the screen brightness for improved picture clarity.

- 1 Press **MENU** and the MENU screen displays.
- 2 Press ◀/▶ to select  (SETUP).
- 3 Press ▲/▼ to select "BACK LIGHTING".
- 4 Press ◀/▶ to adjust the screen brightness.
- 5 Press **EXIT** to return to the normal screen.

Color temperature

For a better white balance, use color temperature correction.

- 1 Press **MENU** and the MENU screen displays.
- 2 Press ◀/▶ to select  (PICTURE).
- 3 Press ▲/▼ to select "COLOR TEMPERATURE".
- 4 Press ◀/▶ to select the mode you prefer.

Selected item	Description
COOL	White with Blueish tone
MEDIUM	Neutral
WARM	White with Reddish tone

- 5 Press **EXIT** to return to the normal screen.

Cinema mode

A smoother motion may be obtained by setting the CINEMA MODE to FILM when you view a DVD from the DVD player connected with the component input.

- 1 Press **MENU** and the MENU screen displays.
- 2 Press ◀/▶ to select  (SETUP).
- 3 Press ▲/▼ to select "CINEMA MODE".
- 4 Press ◀/▶ to select "FILM" or "VIDEO".

Selected item	Description
FILM	Film content viewing mode
VIDEO	Video content viewing mode

Basic adjustment settings

Sound adjustment

You can adjust the sound quality to your preference with the following settings.

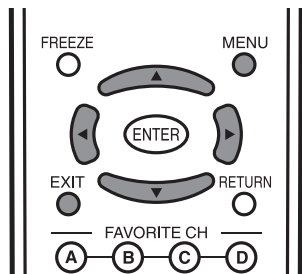

1 Press **MENU** and the MENU screen displays.

2 Press **◀/▶** to select **🎵** (AUDIO).

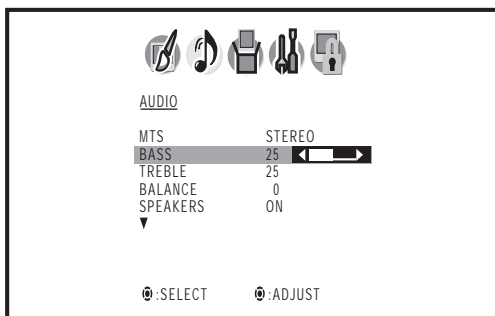

3 Press **▲/▼** to select a specific adjustment item (BASS, TREBLE, BALANCE).

4 Press **◀/▶** to adjust the item to the desired level.

Selected item	◀ button	▶ button
BASS	For weaker bass	For stronger bass
TREBLE	For weaker treble	For stronger treble
BLANCE	Decrease audio from the right speaker	Decrease audio from the left speaker

5 Press **EXIT** to return to the normal screen.

NOTE

- For resetting all Audio adjustment items to the factory preset values, press **▲/▼** to select "RESET", and then press **◀/▶** (see page 26 for further information).

Digital audio output

You can output digital audio to an AV amplifier or similar device whose DIGITAL AUDIO INPUT terminal is connected to the COAXIAL DIGITAL AUDIO OUTPUT terminal on the TV. Please select an audio output format compatible with the audio format of the program you are watching and the equipment connected.

1 Press **MENU** and the MENU screen displays.

2 Press **◀/▶** to select **🎵** (AUDIO).

3 Press **▲/▼** to select "DIGITAL OUTPUT".

4 Press **◀/▶** to select "PCM" or "DOLBY DIGITAL".

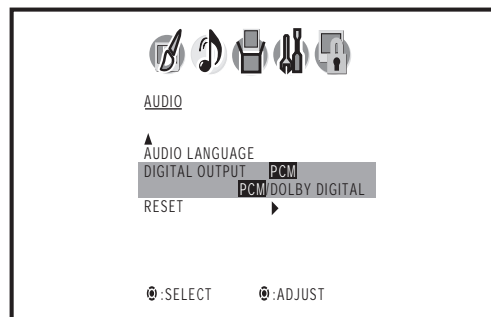

Selected item	Description
PCM	The coaxial digital audio output terminal outputs audio signal in PCM form. If your digital audio system does not support Dolby Digital, select "PCM".
DOLBY DIGITAL	The coaxial digital audio output terminal outputs audio signal in Dolby Digital form. It reproduces sound from surround program of digital.

5 Press **EXIT** to return to the normal screen.

Using external equipment

You can connect many types of external equipment to your TV like a DVD player, VCR, Digital TV tuner, HDMI equipment, game console or camcorder. To view external source images, select the input source from **INPUT** on the remote control unit or on the TV.

Displaying an external equipment image

This explanation is for the setting when connecting a DVD player to the INPUT3 terminal.

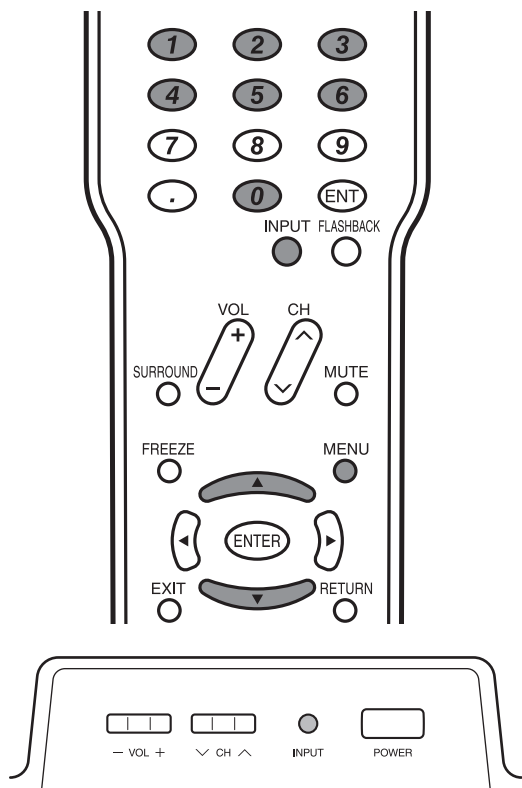

To watch a DVD image, select "INPUT3" from "SOURCE SELECTION" menu using **0-6** on the remote control.

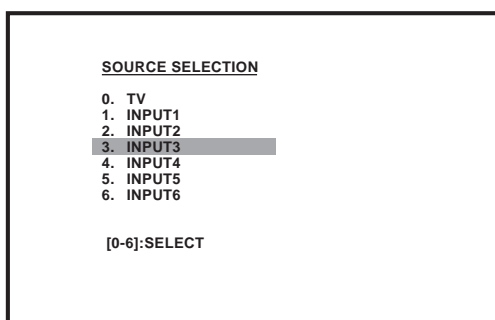

- Each time **INPUT** is pressed, SOURCE SELECTION item toggles.
- You can also select SOURCE SELECTION item by pressing ▲/▼.

CAUTION

- To protect equipment, always turn off the TV before connecting a DVD player, VCR, Digital TV tuner, HDMI equipment, game console, camcorder or other external equipment.

NOTE

- See pages 24 and 25 for external equipment connection.
- Please read the relevant operation manual (DVD player, etc.) carefully before making connections.
- Refer to your external equipment operation manual for the signal type.

Using external equipment

Connecting a DVD player or a digital TV STB (Air or Cable)

You can use the INPUT1~4 terminals when connecting to a DVD player, a Digital TV STB (Air or Cable) and other audiovisual equipment.

When using component cable. (INPUT3 or 4)

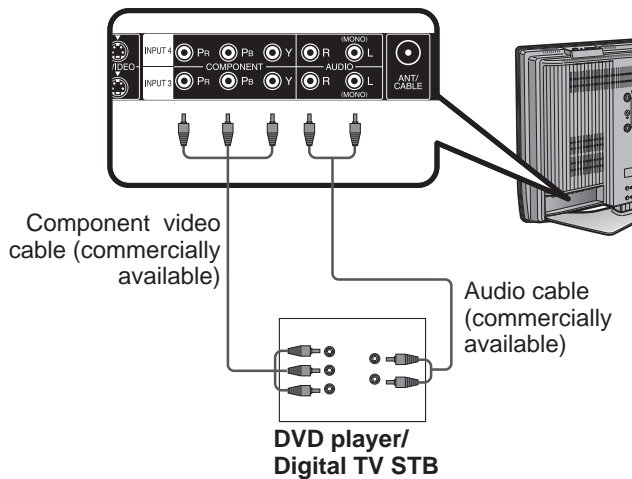

When using composite cable. (INPUT1 or 2)

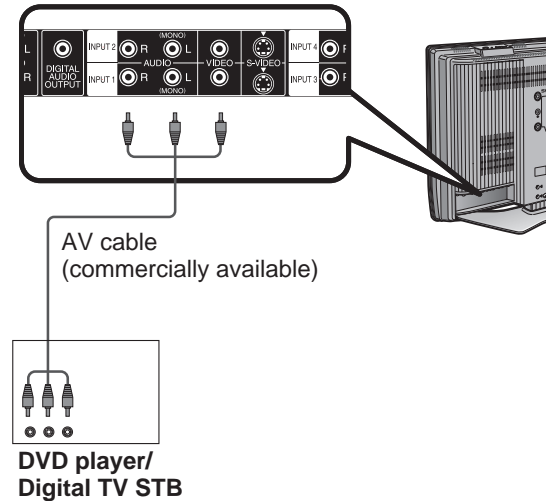

NOTE

- See page 25 for connecting a DVD player or a Digital TV STB to the HDMI terminal.

Connecting a VCR, game console or camcorder

A VCR, game console, camcorder and other audiovisual equipment can be conveniently connected using the INPUT1 or 2 terminals.

NOTE

- The S-video terminal takes priority over the video terminals.

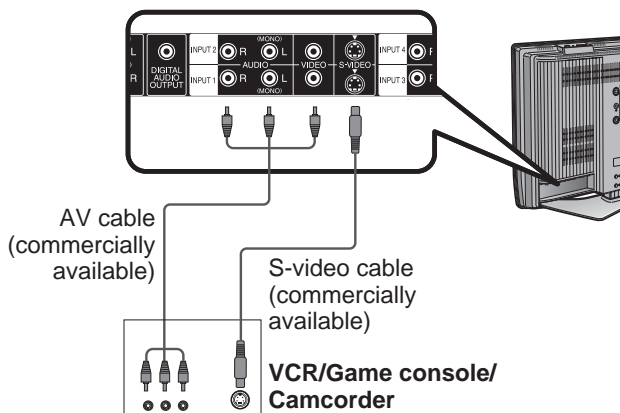

Using digital audio output

It is possible to output audio through the COAXIAL DIGITAL AUDIO OUTPUT terminal. (See page 22 for details.) PCM audio outputs from the terminal.

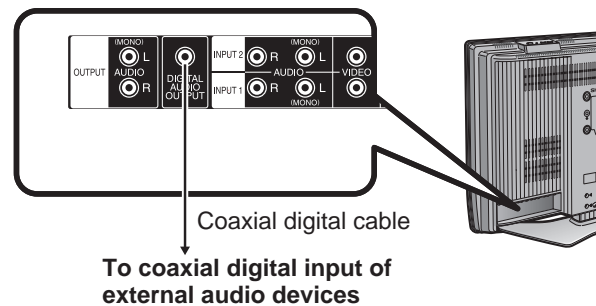

Using external equipment

Connecting HDMI equipment

You can use the INPUT5 or 6 terminal when connecting HDMI equipment.

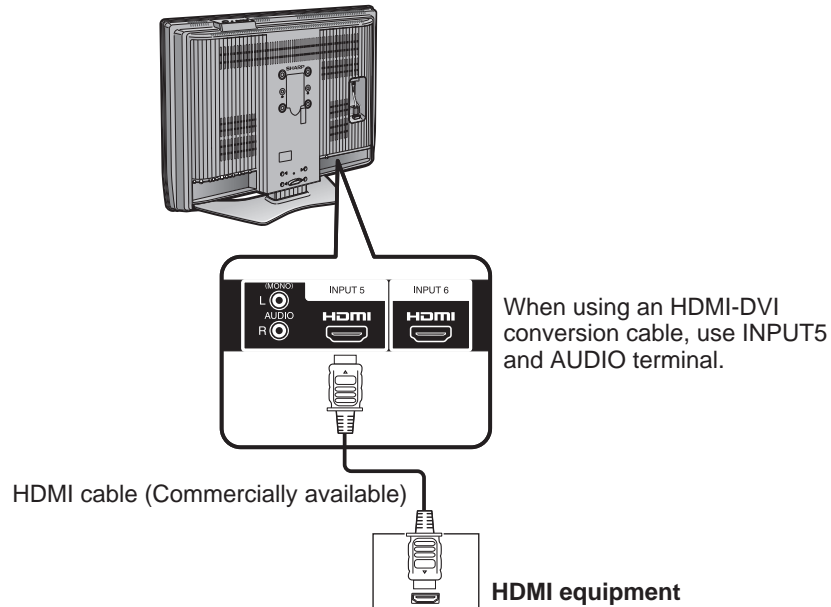

Displaying an image from HDMI equipment

- 1 To watch an HDMI equipment image, select "INPUT5" or "INPUT6" from "SOURCE SELECTION" menu using **INPUT** on the remote control unit or on the TV. (See page 23.)

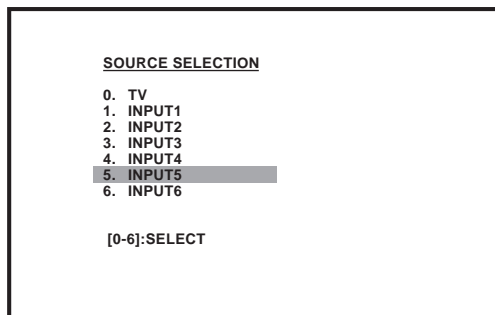

NOTE

- Refer to your external equipment operation manual for the signal type.

Selecting HDMI audio input source

- 1 Press **MENU** and the MENU screen displays.
- 2 Press ◀▶ to select (AUDIO).
- 3 Press ▲▼ to select "HDMI".
- 4 Press ◀▶ to select "HDMI" or "DVI".

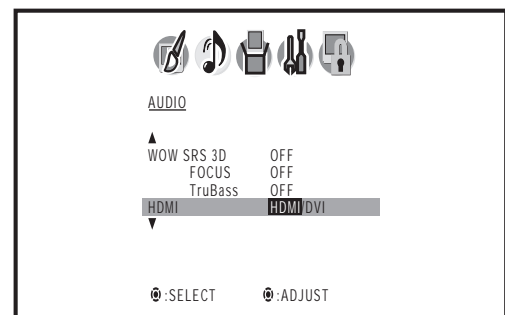

HDMI: When you connect the HDMI device to the TV, select this setting.

DVI: When you connect the DVI device to the TV with analog audio cords, select this setting.

- 5 Press **EXIT** to return to the normal screen.

Useful adjustment settings

Reset

If complex adjustments are made and the settings cannot be restored to normal, you can reset the settings to the factory preset values.

Resetting picture adjustments

Each picture adjustments return to the following factory settings:

AV MODE STANDARD
 BRIGHTNESS / COLOR / SHARPNESS center (25)
 CONTRAST (40)
 TINT center (0)
 COLOR TEMPERATURE COOL

1 Press **MENU** and the MENU screen displays.

2 Press **◀/▶** to select  (PICTURE).

3 Press **▲/▼** to select "RESET", and then press **◀/▶**.

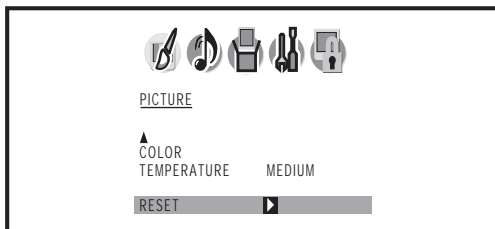

4 The TV screen return to the normal screen, and "RESET" will be displayed a few seconds.

Resetting audio adjustments

Each audio adjustments return to the following factory settings:

BASS center (25) BALANCE center (0)
 TREBLE center (25)

1 Press **MENU** and the MENU screen displays.

2 Press **◀/▶** to select  (AUDIO).

3 Press **▲/▼** to select "RESET", and then press **◀/▶**.

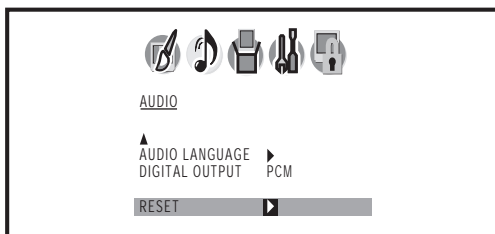

4 The TV screen return to the normal screen, and "RESET" will be displayed a few seconds.

NOTE

- The channel setup settings will not be changed.
- The language settings will not be changed.
- The password number setting will not be changed.

Input label

Let you set the input terminal displayed when using the "SOURCE SELECTION" menu or channel display.

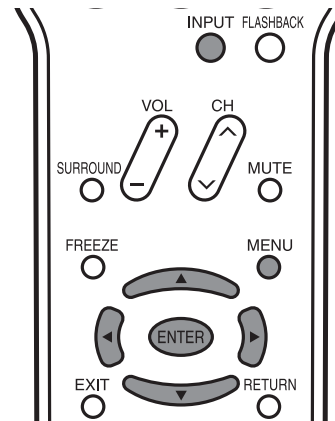

1 Press **MENU** and the MENU screen displays.

2 Press **◀/▶** to select  (OPTION).

3 Press **▲/▼** to select "VIDEO LABEL", and then press **◀/▶**.

4 The VIDEO LABEL menu screen displays. Press **▲/▼** to select the specific input source which you want to change.

5 Press **◀/▶** to select the new label for the selected input source.

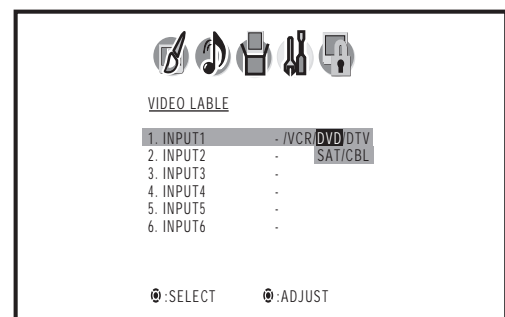

-	Uses the default label name
VCR	Video cassette recorder
DVD	DVD video
DTV	Digital TV set-top box
SAT	Satellite box
CBL	Cable box
HD	HDMI equipment

6 Press **EXIT** to return to the normal screen.

NOTE

- You cannot change label for "TV" input.

Useful adjustment settings

AV mode

AV mode gives you four viewing options to choose from to best match the surrounding environment of the TV, which can vary due to factors like room brightness, type of program watched or the type of image input from external equipment.

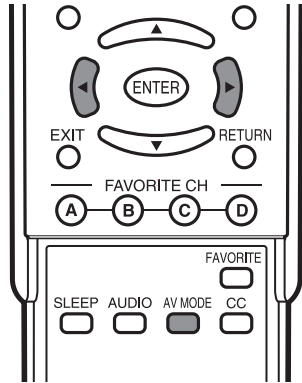

- 1 Press **AV MODE** and the (PICTURE) menu screen displays. "AV MODE" will be highlighted.
- 2 Press to select the desired mode.
 - The mode can be chosen from the list below.

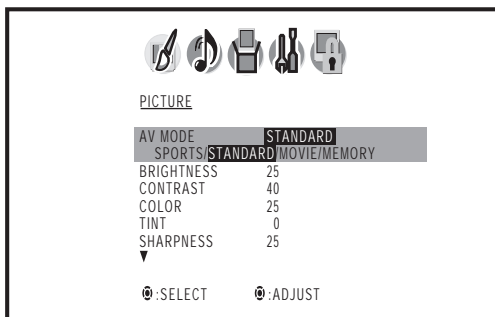

Selected item	Description
SPORTS	For a clear-cut image emphasizing high contrast, useful for sports viewing
STANDARD	For a highly defined image in a normal lighting
MOVIE	For a movie
MEMORY	Allows the user to customize settings as desired. You can set the mode for each input source.

- 3 Press **EXIT** to return to the normal screen.

NOTE

- Each time **AV MODE** is pressed, AV MODE item toggles.
- You can select a different AV MODE item for each input mode. (For example, select STANDARD for TV input and SPORTS for VIDEO input.)

Selecting the digital audio language

When two or more audio languages are included in a digital signal, you can select one of the audio languages.

- 1 Press **MENU** and the MENU screen displays.
- 2 Press to select (AUDIO).
- 3 Press to select "AUDIO LANGUAGE", and then press .

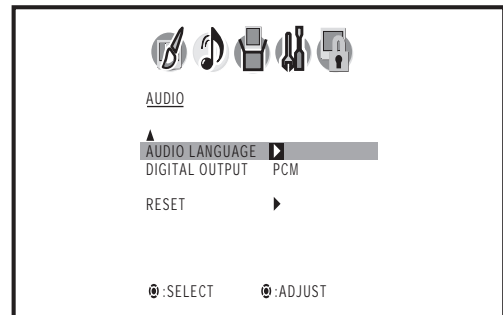

- 4 Press to select your desired language, then press **ENTER**.

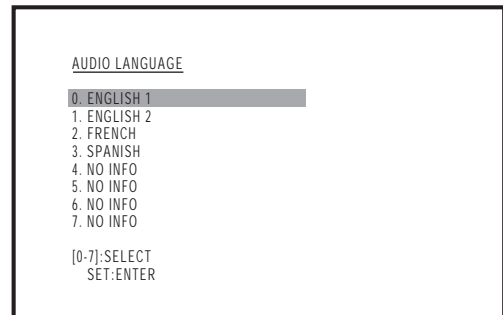

- 5 Press **EXIT** to return to the normal screen.

Useful adjustment settings

View mode for 4:3 programs

- 1 Press **VIEW MODE**.
 - The View mode menu displays.
 - The menu lists the view mode options selectable for the type of video signal currently being received.
- 2 Press **0-3** to select each view mode directly while the view mode menu is still on the screen.
 - Each time **VIEW MODE** is pressed, **VIEW MODE** item toggles.
 - You can also select **VIEW MODE** item by pressing **▲/▼**.
 - You can sequentially select a view mode that has its own aspect ratio.

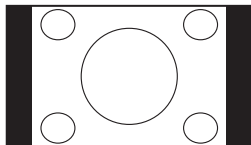
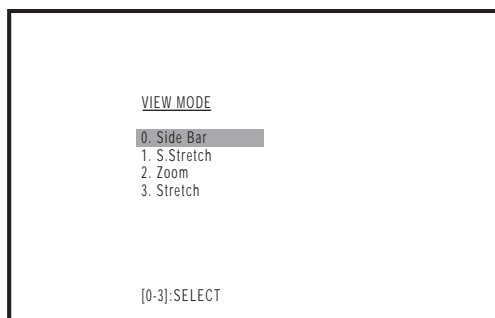

Side Bar:
Suitable for viewing conventional 4:3 programs in their normal format.

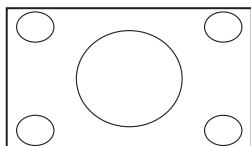

S.Stretch (Smart stretch):
Suitable for stretching 4:3 programs to fill the screen.

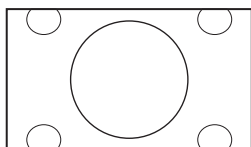

Zoom:
Suitable for viewing wide-screen 2.35:1 anamorphic DVDs in full screen.

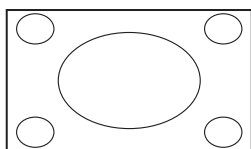

Stretch:
This mode is useful for 1.78:1 DVDs. When viewing 1.85:1 DVDs, stretch mode will still show very thin black bands at the top and bottom of the screen.

NOTE

- You can enter to the same menu screen from  (SETUP) menu.
- When this function is not available, "NOT AVAILABLE" will display.

View mode for HD programs

Stretch mode is available for HD programs. Suitable for viewing wide-screen 1.78:1 aspect-ratio programs. When viewing 1.85:1 programs, the stretch mode will still show very thin black bands at the top and bottom of the screen.

Picture scroll

For adjusting a picture's vertical position in S.Stretch or Zoom mode.

- 1 Press **MENU** and the MENU screen displays.
- 2 Press **◀/▶** to select  (SETUP).
- 3 Press **▲/▼** to select "PICTURE SCROLL", and then press **◀/▶**.
- 4 **SCROLL ADJUSTMENT** screen displays. To raise the picture, press **▲**. To lower the picture, press **▼**.

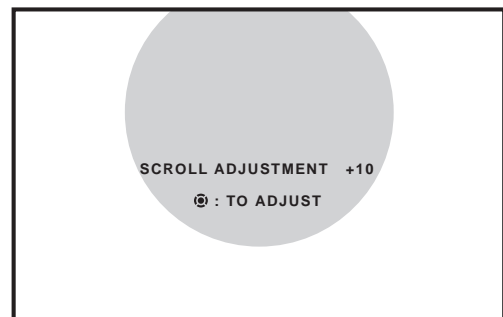

The scroll amounts are as follows:

- 480i/480p signal source:
 - Zoom: -10 to +20
 - S.Stretch: -10 to +20

- 5 Press **EXIT** to return to the normal screen.

NOTE

- In Side Bar and Stretch mode, **PICTURE SCROLL** will not work.

Aspect

When the **ASPECT** is set to **ON** and the TV receives a 480i signal, the picture size is automatically selected (as described in the following table).

- 1 Press **MENU** and the MENU screen displays.
- 2 Press **◀/▶** to select  (SETUP).
- 3 Press **▲/▼** to select "ASPECT", and then press **◀/▶** to select "ON" or "OFF".
- 4 Press **EXIT** to return to the normal screen.

Aspect ratio of signal source	Automatic aspect size (when ASPECT is ON)
4:3 Normal	Side Bar
16:9 Full	Stretch
4:3 Letter box	Stretch
Not defined	User-set mode

Useful adjustment settings

Audio output select

Allows you to select what controls the audio output.

- 1 Press **MENU** and the MENU screen displays.
- 2 Press **◀/▶** to select  (AUDIO).
- 3 Press **▲/▼** to select "SPEAKERS".
- 4 Press **◀/▶** to select "ON" or "OFF".

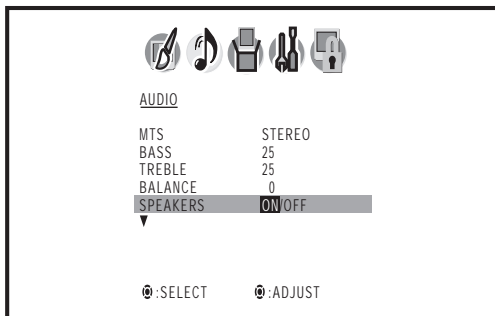

Selected item	Description
ON	<ul style="list-style-type: none"> • Sound via speaker is adjusted with VOL +/- on the remote control unit or VOL +/- on the TV. • Sound via the AUDIO OUTPUT terminal is not adjustable and outputs at a consistent level.
OFF	<ul style="list-style-type: none"> • Sound via the AUDIO OUTPUT terminal is adjusted with VOL +/- on the remote control unit or VOL +/- on the TV. • Sound via speaker is muted.

- 5 Press **EXIT** to return to the normal screen.

Sleep timer

Allows you to set a time when the TV automatically switches to standby.

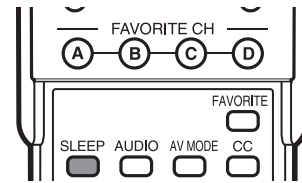

- 1 Each time you press **SLEEP**, the remaining time setting switches as shown below.

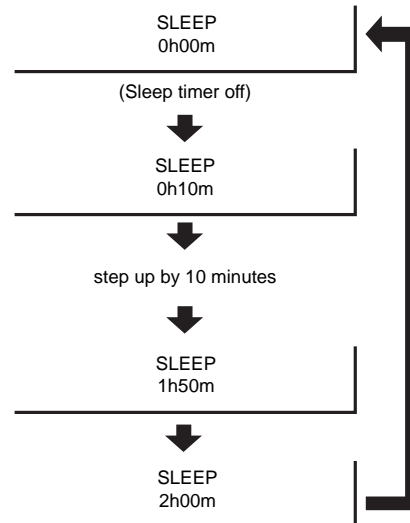

This display will disappear after a few seconds, the sleep timer automatically starts counting down.

- If you want to adjust the sleep timer again, you can press **SLEEP** repeatedly then change the time setting.

- 2 Press **SLEEP**.
 - The remaining time displays when the sleep timer has been set.

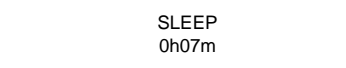

NOTE

- Select "0h00m" by pressing **SLEEP** repeatedly to cancel the sleep timer.
- The TV will enter the standby mode when the remaining time reaches zero.

Useful adjustment settings

Closed captions and digital closed captions

Your TV is equipped with an internal Closed Caption decoder. It allows you to view conversations, narration and sound effects as subtitles on your TV. Closed Captions are available on some TV programs and on some VHS home video tapes at the discretion of the program provider.

Digital Closed Caption service is a new caption service available only on digital TV programs (also at the discretion of the service provider). It is a more flexible system than the original Closed Caption system, because it allows a variety of caption sizes and font styles. When the Digital Closed Caption service is in use, it will be indicated by the appearance of a 3-letter abbreviation that also indicates the language of the Digital Closed Captions: ENG (English), SPA (Spanish), FRA (French) or other language codes.

Not all programs and VHS videotapes offer closed captions. Please look for the "CC" symbol to ensure that captions will be shown.

In the Closed Caption system, there can be more than one caption service provided. Each is identified by its own number. The "C1" and "C2" services display subtitles of TV programs superimposed over the program's picture. Generally, Closed Captions in English are transmitted on C1 and Closed Captions in other languages are transmitted on C2.

In the Closed Caption system, the "Text1" or "Text2" services display text that is unrelated to the program being viewed (e.g., weather or news). These services are also superimposed over the program currently being viewed.

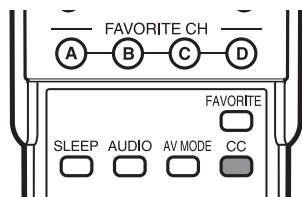

NOTE

- If the program or video you selected is not closed-captioned, no captions will display on-screen.
- If text is not available in your viewing area, a black rectangle may appear on-screen. If this happens, set the Closed Caption feature to "OFF".
- When selecting Closed Captions, the captioning will be delayed approx. 10 seconds.
- If no caption signal is received, no captions will appear, but the television will remain in the Caption Mode.
- Misspellings or unusual characters may occasionally appear during Closed Captioning. This is normal with Closed Captioning, especially with live programs. This is because during live programs, captions are also entered live. These transmissions do not allow time for editing.
- When Captions are being displayed, on-screen displays, such as volume and mute may be seen but may interfere with Closed Captions.
- Some Cable TV systems and copy protection systems may interfere with the Closed Captioned signal.
- If using an indoor antenna or if TV reception is very poor, the Closed Caption Decoder may not appear or may appear with strange characters or misspelled words. In this case, adjust the antenna for better reception or use an outdoor antenna.

1

Tune the TV to the desired program.

2

Press **CC** to display "CLOSED CAPTION" menu.

3

Press **CC** repeatedly to select your desired Closed Caption mode.

- When an Analog signal is received, you can choose C1, C2, T1, T2 and OFF.

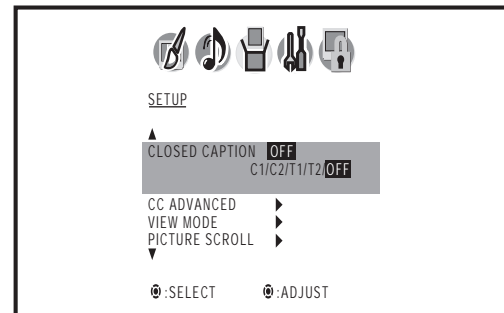

- When a Digital signal is received, you can choose from CS1, CS2, CS3, CS4, CS5, CS6, C1, C2, C3, C4, T1, T2, T3, T4 and OFF.

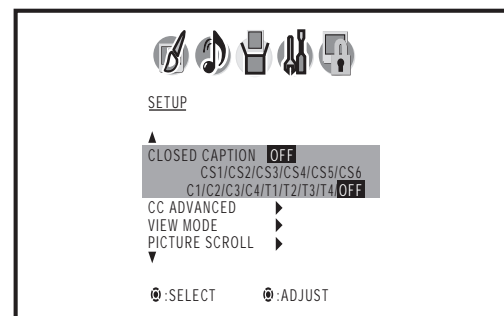

- Depending on the broadcast signal, some Analog Captions will function with a Digital broadcast signal.

4

Press **EXIT** to return to the normal screen.

NOTE

- You can enter to CLOSED CAPTION menu from (SETUP) menu.
- To turn the Closed Caption feature off, select "OFF".

Useful adjustment settings

Caption setup

This function allows you to adjust the closed caption screen appearance to suit your preference.

1 Press **MENU** and the MENU screen displays.

2 Press ◀/▶ to select  (SETUP).

3 Press ▲/▼ to select “CC ADVANCED”, and then press ◀/▶. The CC ADVANCED menu displayed.

- You can adjust 5 items here.

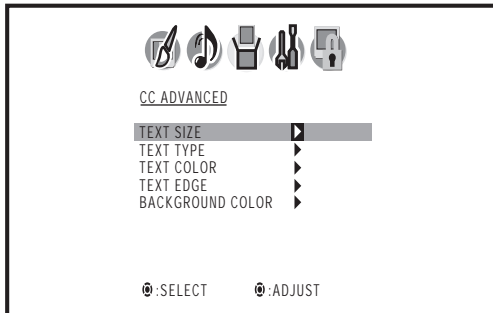

4 Press ▲/▼ to select a specific adjustment item, then press ◀/▶. The selectable parameter of each items will appear.

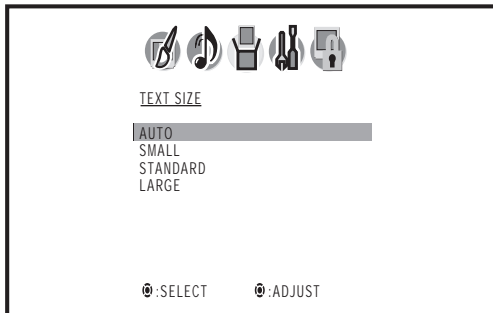

5 Press ▲/▼ to select the desired parameter.

6 Press **EXIT** to return to the normal screen.

Selectable parameters available in each adjustment item.

Item	Selectable parameter
TEXT SIZE:	AUTO, SMALL, STANDARD, LARGE
TEXT TYPE:	AUTO, DEFAULT, MONO W. SERIF, PROP. W. SERIF, MONO W/O SERIF, PROP. W/O SERIF, CASUAL, CURSIVE, SMALL CAPITALS
TEXT COLOR:	AUTO, BLACK, WHITE, RED, GREEN, BLUE, YELLOW, MAGENTA, CYAN
TEXT EDGE:	AUTO, NONE, RAISED, DEPRESSED, UNIFORM, LEFT DROP SHADOW, RIGHT DROP SHADOW
BACKGROUND COLOR:	AUTO, BLACK, WHITE, RED, GREEN, BLUE, YELLOW, MAGENTA, CYAN

NOTE

- This feature is designed to customize Digital Captions only.
- The “AUTO” value depends on the broadcasting station.

Useful adjustment settings

Password setting for parental control

Allows you to use a password to protect certain settings from being accidentally changed.

IMPORTANT:

Two conditions must be met to enable the V-Chip

- ① Password is registered.
- ② V-CHIP settings have been made.
- ③ "V-CHIP" is set to "ON".

Setting a password

- 1 Press **MENU** and the MENU screen displays.
- 2 Press **◀/▶** to select  (LOCKS).
- 3 Press **▲/▼**. The password entering menu displays.
- 4 Select and enter a password (4 digits) using the **number buttons (0–9)**, then press **ENTER**.

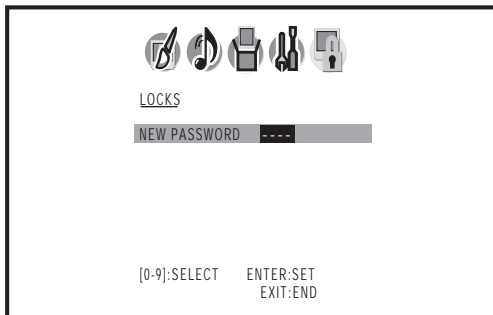

"*" appears instead of the number.

- 5 Enter the same password again to confirm, then press **ENTER**, the password is now registered and the V-CHIP SET menu will appear on the screen.

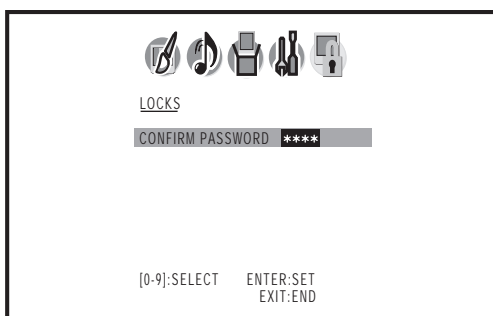

Changing the password

Allows you to change your current password.

- 1 Repeat steps 1 to 3 in **setting a password**.
 - The password entering menu displays.
- 2 Input the 4-digit password by using **0–9**.
- 3 Press **▲/▼** to select "NEW PASSWORD", then press **◀/▶**.

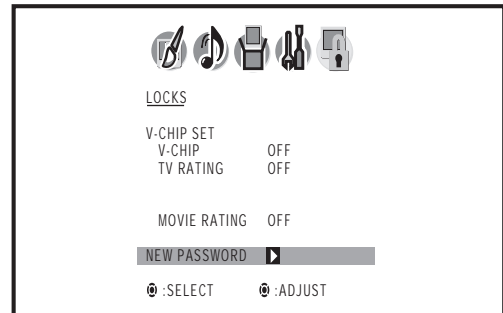

- 4 Enter a new password using **0–9**, then press **ENTER**.



- 5 Enter the same password again to confirm, then press **ENTER**.

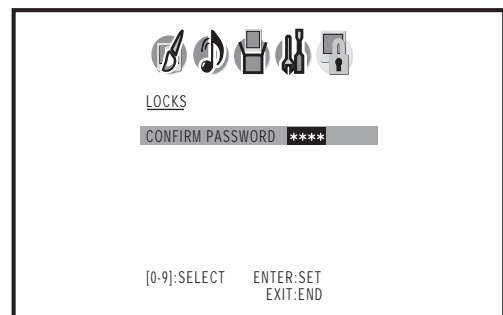

- 6 The screen returns to V-CHIP SET menu. Your new password has been set.

NOTE

- As a precautionary measure, make a note of your password and keep it in a familiar place.

Useful adjustment settings

Parental control (V-CHIP)

V-CHIP is an electronic filtering device built into your TV. This tool gives parents a great degree of control over broadcasts accessed by their children. It allows parents to select programs judged suitable for child viewing while blocking ones judged not suitable. It does so automatically once you activate the V-CHIP feature in your TV.

V-CHIP SET menu will not be selectable from the menu if you do not first configure your password.
(See page 32 for password setting for parental control.)

- The U.S. has two rating systems for viewing content: movie ratings and TV Parental Guidelines.
- The TV Parental Guidelines work in conjunction with the V-CHIP to help parents screen out inappropriate television shows from their children.
- Movie ratings are used for original movies rated by the Motion Picture Association of America (MPAA) as watched on cable TV and not edited for television. The V-CHIP can also be set to block MPAA-rated movies.

TV Parental Guidelines

TV RATING		Content				
		FANTASY VIOLENCE	VIOLENCE	SEXUAL SITUATIONS	ADULT LANGUAGE	SEXUAL DIALOG
Suggested age	TV-Y (All children)					
	TV-Y7 (Directed to older children)	X				
	TV-G (General audience)					
	TV-PG (Parental Guidance suggested)		X	X	X	X
	TV-14 (Parents strongly cautioned)		X	X	X	X
	TV-MA (Mature audience only)		X	X	X	

X: Content rating can be set.

Voluntary movie rating system (MPAA)

MOVIE RATING	Description
G	General audiences. All ages admitted.
PG	Parental guidance suggested. Some material may not be suitable for children.
PG-13	Parents strongly cautioned. Some material may be inappropriate for children under 13.
R	Restricted. Under 17 requires accompanying parent or adult guardian (age varies in some jurisdictions).
NC-17	No one 17 and under admitted.
X	X is an older rating that is unified with NC-17 but may be encoded in the data of older movies.

EXAMPLE

- If you select "PG-13", this will automatically block the higher ratings "R", "NC-17" and "X".

NOTE

- Voluntary movie rating system only uses an age-based rating.

Useful adjustment settings

TV Parental Guidelines (TV Guidelines)

- 1 Press **MENU** and the MENU screen displays.
- 2 Press **◀/▶** to select  (LOCKS).
- 3 Press **▲/▼**. The password entering menu displays.
- 4 Input the 4-digit password by using **0–9**. The V-CHIP SET menu displays.
- 5 Press **▲/▼** to select "TV RATING". Then press **◀/▶** to select the desired rating.

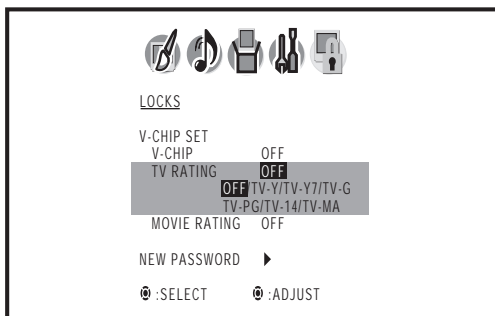

- When you select TV-Y7, TV-PG, TV-14 or TV-MA, "DISPLAY TO SET CONTENTS" will appear on the screen. Press **DISPLAY** to explain the rating. Press **▲/▼** to select the desired rating you want. Press **◀/▶** to select the setting "ON" or "OFF". Then press **RETURN**.

- See page 33 for setting details.

- 6 Press **▲/▼** to select "V-CHIP".
- 7 Press **◀/▶** to select "ON".
 - If "V-CHIP" is not set to "ON" the V-CHIP settings will not work.
- 8 Press **EXIT** to return to the normal screen. Your setting are now set into memory.

Voluntary movie rating system (MPAA)

- 1 Repeat steps 1 to 4 in **TV Parental Guidelines (TV Guidelines)**.
- 2 Press **▲/▼** to select "MOVIE RATING". Then press **◀/▶** to display the desired rating.

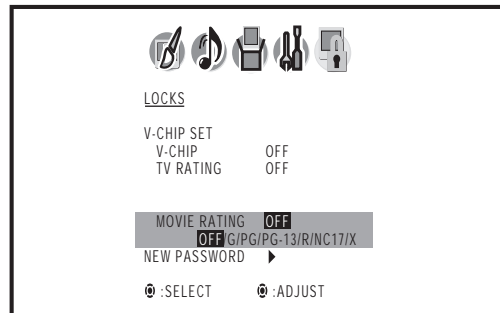

- See page 33 for setting details.

- 3 Press **EXIT** to return to the normal screen.

How to temporarily release the V-CHIP block

The V-CHIP block is working and censors a broadcast, "THIS PROGRAM HAS BEEN BLOCKED!" displays.

- 1 Press **MUTE** while the V-CHIP is working and then the password entering menu displays.
- 2 Enter your 4-digit password with **0–9**. At this time V-CHIP block temporarily releases.

Reactivating the temporarily released V-CHIP block

You can reactivate the temporarily released V-CHIP block as shown below.

Method 1:

Change to the other channel.

Method 2:

Switch off the TV power.

NOTE

- Performing any of the two above will activate the V-CHIP block.

Other viewing options

Freezing images

Allows you to capture and freeze an image from a moving image that you are watching.

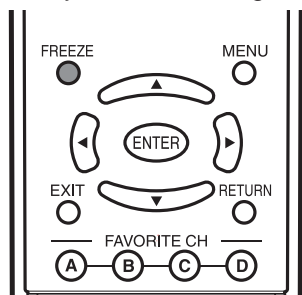

- 1 Press **FREEZE**.
 - A moving image is captured.
- 2 Press **FREEZE** again to cancel the function.

NOTE

- When this function is not available, "NOT AVAILABLE" will display.
- The still image automatically goes out after 30 minutes.
- If you are using the freeze function and a broadcast activates the V-CHIP block, the freeze function will be cancelled and a V-CHIP block message will appear.

Signal meter

In order to receive digital air broadcasts, you need a digital broadcast antenna. You can confirm the antenna configuration through the "SIGNAL METER" menu.

If necessary, adjust the direction of the antenna to obtain the maximum signal strength.

Signal strength

- 1 Press **MENU** and the MENU screen displays.
- 2 Press **◀/▶** to select  (SETUP).
- 3 Press **▲/▼** to select "SIGNAL METER".
- 4 Press **◀/▶**.
 - The strength of the digital signal is displayed. The signal information is based on the current channel.

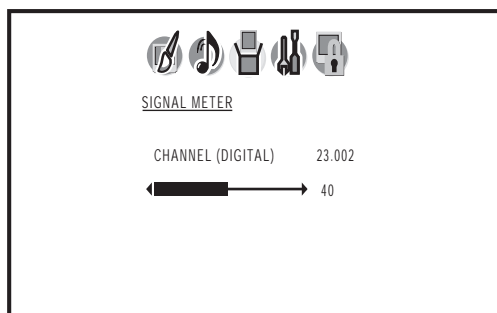

- 5 Press **EXIT** to return to the normal screen.

Presetting remote control function

You can operate the connected AV products (AV Receiver, Cable Box, SAT tuner, DTV, VCR, DVD, LD) using the presetting manufacturer function of your remote control unit.

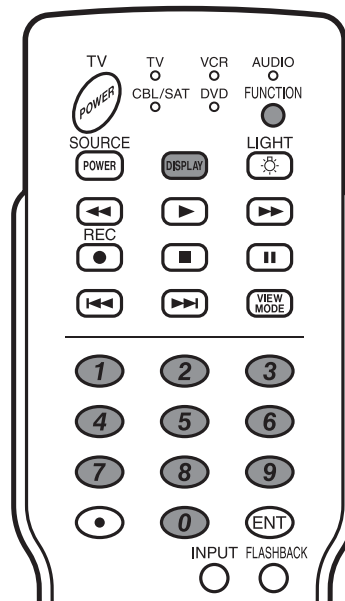

Presetting manufacturer codes

- 1 Press **FUNCTION** until the LED for your device lights up.
- 2 After the LED for your device lights up, press **FUNCTION** and **DISPLAY** at the same time to enter the code registration mode. The LED will blink.
- 3 Press **0-9** to enter the manufacturer code. (See page 36.)
 - Preset mode is finished once the LED no longer lights up.
- 4 After registering the code, the LED will stop blinking then turn off after one second. (If you perform an incorrect operation, the LED will blink quickly then turn off.)

Other viewing options

Manufacturer codes

VCR BRAND	REMOTE CONTROL CODE NUMBER
Akai	25, 26, 37
Audio	15, 22, 30
Broksonic	32
Canon	04
Capehart	34
Craig	10, 31
Curtis Mathis	04
Daewoo	34
DBX	15, 22, 30
Dynatech	29
Emerson	21, 32, 35
Fisher	09, 10, 11
Funai	28, 29
G.E.	04
Goldstar	24
Hitachi	06, 47
Instant Replay	04
JC Penney	04, 06, 24, 30
JVC	15, 41, 42, 53
Kenwood	14, 15
Lloyds	29
Magnavox	04, 05, 08
Magnin	31
Marantz	30
Memorex	04, 10, 24, 29
Minolta	06
Mitsubishi	17, 18, 39, 40
Montgomery Ward	02, 43
Multitech	29
NEC	15, 22, 30
Panasonic	44, 45
Pentax	05, 06
Philco	05
Philips	05, 08
RCA	06, 07, 33, 51
Realistic	01, 02, 10, 24
Samsung	23, 31
Sanyo	10, 14, 52
Scott	20
Sears	06, 11, 24
Sharp	01, 02, 03
Shintom	36
Sony	12, 13, 38
Sound Design	29
Sylvania	05, 08
Symphonic	29
Tatung	15
Teac	15, 29
Teknika	27, 29
Thomas	29
TMK	21
Toshiba	19, 20
Video Concepts	30
Yamaha	15, 29, 30
Zenith	16

DVD/LD BRAND	REMOTE CONTROL CODE NUMBER
Denon	02
JVC	09, 13
Kenwood	21
Magnavox	04
Marantz	04
Mitsubishi	06
Panasonic	02, 22
Philips	04, 23
Pioneer	08, 11, 20
Proscan	03
RCA	03, 24
Samsung	07, 12
Sharp	01, 10
Sony	05, 25
Toshiba	04
Yamaha	02
Zenith	04

CATV/SAT BRAND	REMOTE CONTROL CODE NUMBER
Anvision	04, 05
Cable Star	04, 05
Eagle	05
General Instrument	02, 03, 07, 12, 13, 14, 19, 22
Jerrold	02, 03, 07, 12, 13, 14, 19, 22, 31, 32, 33, 34, 35, 36, 37, 38, 39, 40
Magnavox	04, 05, 09, 14, 17, 18, 20, 21, 24, 25
Oak Sigma	8
Panasonic	16, 23
Philips	04, 05, 09, 15, 17, 18, 20, 21, 24, 25
Pioneer	08, 10, 29, 30, 43*, 46
Randtek	04, 05
RCA	16, 27, 44*, 45*
Scientific Atlanta	01, 26
Sony	28
Viewstar	04, 05, 09, 15, 17, 18, 20, 21, 24, 25
Zenith	06, 14

NOTE

- Numbers marked with * are SAT codes, all others are CATV codes.

AUDIO BRAND	REMOTE CONTROL CODE NUMBER
Sharp	01

Other viewing options

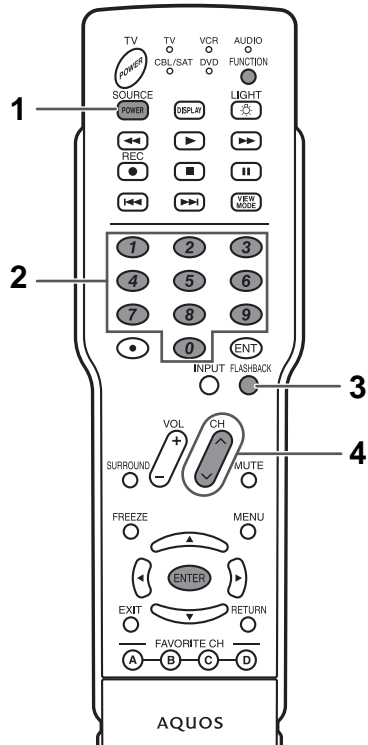

Cable control buttons

When the **FUNCTION** is set to CBL/SAT, the cable converter connected to the TV can be operated using 1 to 4.

1 SOURCE POWER

Turns the cable converter power on and off.

2 0-9

Press a button (or buttons) that corresponds to the channel that you wish to watch.

3 FLASHBACK *

Press to switch between the current channel and the channel you were watching immediately before.

4 CH ^ / v

Press **CH ^** or **CH v** to tune in a higher or lower channel.

* Some manufacturers do not preset **FLASHBACK**.

NOTE

- CABLE and SAT cannot be selected at the same time.

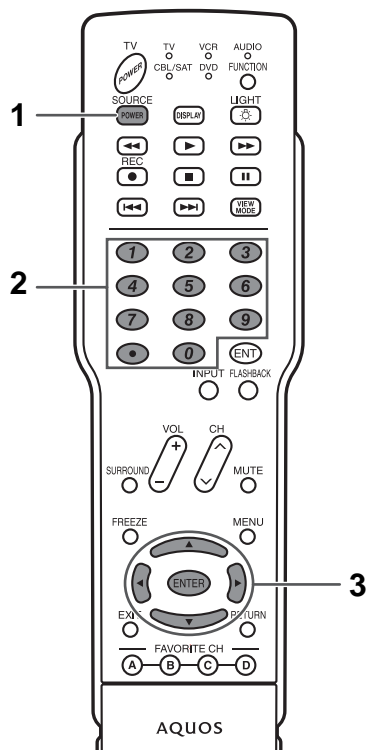

SAT control buttons

1 SOURCE POWER

Turns the cable converter power on and off.

2 0-9, • (DOT)

Press a button (or buttons) that corresponds to the channel that you wish to watch.

3 ENTER, ▲/▼/◀/▶

ENTER: Press to activate the selected function.

▲/▼/◀/▶: Press the button to select items on the SAT GUIDE screen or SAT MENU screen.

NOTE

- CABLE and SAT cannot be selected at the same time.

Other viewing options

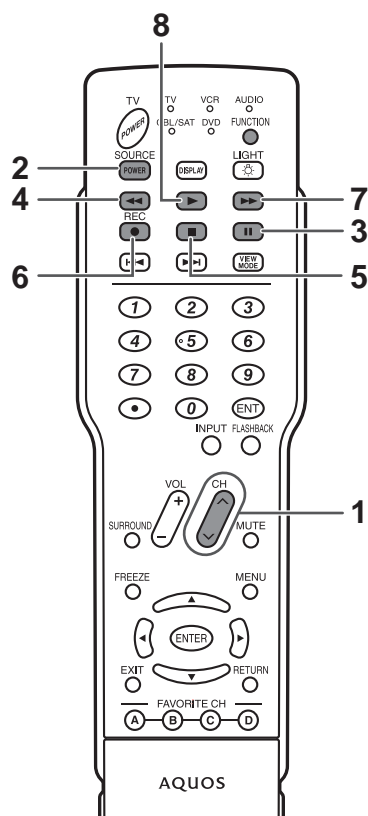

VCR control buttons

The remote control unit button will function as follows when the **FUNCTION** of the remote control unit is set to VCR.

- Press **INPUT** until the input connected to the VCR is selected. The following 1 to 8 can be used to control the VCR.
- CH** ^ / ∨
Press to select the channel of the TV tuner on the VCR.
 - SOURCE POWER**
Turns the power of the VCR on and off.
 - II**
Sets pauses and still pictures.
 - ◀◀**
Rewinds the tape and allows picture search.
 - Stops the tape transport.
 - REC**
Starts recording.
 - ▶▶**
Rapidly advances the tape and allows picture search.
 - ▶**
Starts playback.

DVD control buttons

The remote control unit button will function as follows when the **FUNCTION** of the remote control unit is set to DVD.

- Press **INPUT** until the input connected to the DVD player is selected. The following 1 to 10 can be used to control the DVD player.
- ▶▶**
Pressing quickly once takes you to the start of the next chapter. Each time you press it, you move ahead to the start of the next chapter.
 - ◀◀**
Pressing quickly once takes you to the start of the chapter currently playing. Each time you press it, you move back to the start of the previous chapter.
 - SOURCE POWER**
Turns the power of the DVD player on and off.
 - II**
Set pauses and still pictures.
 - ◀◀**
Hold down to go in reverse.
 - Playback stops when pressed. With some DVD players, pressing the button twice may open the disc tray.
 - MENU**
When this button is pressed, the DVD menu will display.
 - ENTER, ▲/▼/◀/▶**
ENTER: Press to activate the selected function.
▲/▼/◀/▶: Press the button to select items on the DVD MENU screen.
 - ▶▶**
Hold down to fast forward.
 - ▶**
Starts playback.

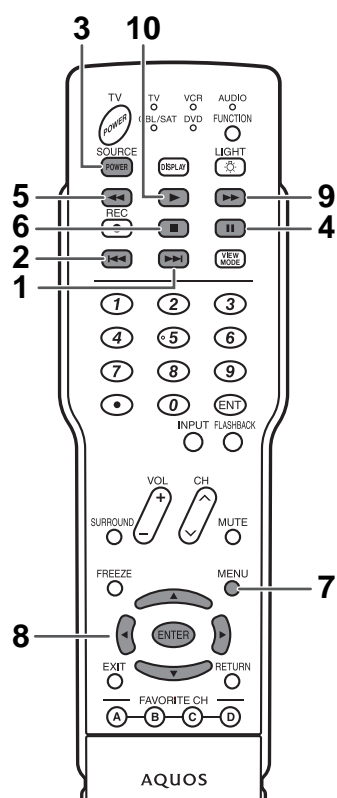

Appendix

Removing the stand

Before detaching (or attaching) stand, unplug the AC cord from the AC INPUT terminal.

CAUTION

- Do not remove the stand from the TV unless using an optional wall mount bracket to mount it.

Before attaching/detaching stand

- Before performing work make sure to turn off the TV.
- Before performing work spread cushioning over the base area to lay the TV on. This will prevent it from being damaged.

1

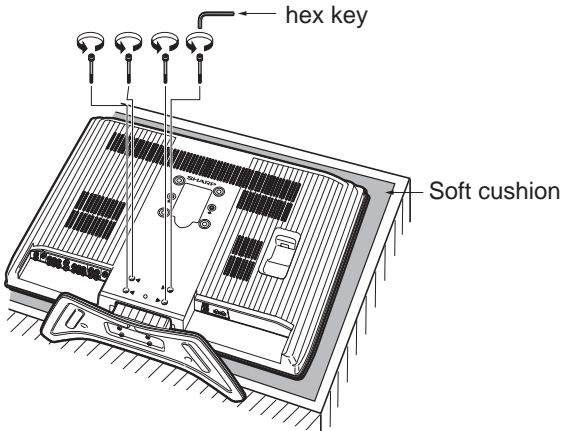

hex key

Soft cushion

Unfasten the four screws used to secure the stand in place.

2

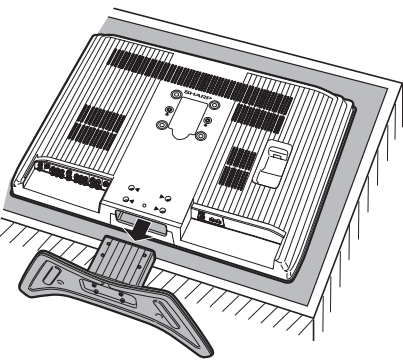

Detach the stand from the TV.
(Hold the stand so it will not drop from the edge of the base area.)

NOTE

- To attach the stand, perform the above steps in reverse order.

Setting the TV on the wall

CAUTION

- Installing the TV requires special skill that should only be performed by qualified service personnel. Customers should not attempt to do the work themselves. SHARP bears no responsibility for improper mounting or mounting that results in accident or injury.

Using an optional bracket to mount the TV

- You can ask a qualified service professional about using an optional AN-26AG1 bracket for LC-26D40U or AN-37AG2 bracket for LC-32D40U to mount the TV to the wall.
- Carefully read the instructions that come with the bracket before beginning work.

Hanging on the wall
Wall mount bracket. (See the bracket instructions for details.)

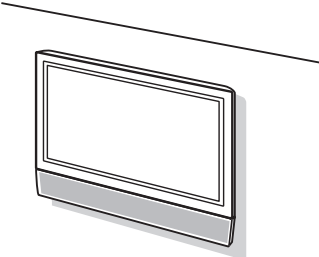
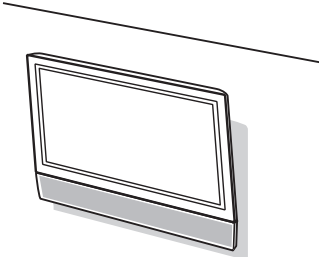



Vertical mounting

Angular mounting

About setting the TV angle

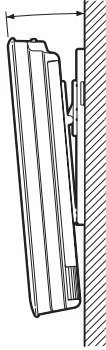
Selected item	Angle of TV
LC-26D40U	Up to 20°
LC-32D40U	Up to 10°



NOTE

- Detach the cable clamp on the rear of the TV when using the optional mount bracket.

Appendix

Troubleshooting

Problem	Possible Solution
<ul style="list-style-type: none"> No power 	<ul style="list-style-type: none"> Check if you pressed TV POWER on the remote control unit. (See page 14.) If the indicator on the TV does not light up, press TV POWER on the TV. Is the AC cord disconnected? (See page 7.) Has the power been turned on? (See page 14.)
<ul style="list-style-type: none"> Unit cannot be operated. 	<ul style="list-style-type: none"> External influences such as lightning, static electricity, may cause improper operation. In this case, operate the unit after first turning on the power of the TV or unplugging the AC cord and replugging it in after 1 or 2 minutes.
<ul style="list-style-type: none"> Remote control unit does not operate. 	<ul style="list-style-type: none"> Is the FUNCTION set correctly? Set it to the TV setting position. Are batteries inserted with polarity (+, -) aligned? (See page 8.) Are batteries worn out? (Replace with new batteries.) Are you using it under strong or fluorescent lighting? Is a fluorescent light illuminated near the remote control sensor?
<ul style="list-style-type: none"> Picture is cut off screen. 	<ul style="list-style-type: none"> Are screen mode adjustments such as view mode choose made correctly? (See page 28.)
<ul style="list-style-type: none"> Strange color, light color, or color misalignment 	<ul style="list-style-type: none"> Adjust the picture tone. (See pages 21–22.) Is the room too bright? The picture may look dark in a room that is too bright.
<ul style="list-style-type: none"> Power is suddenly turned off. 	<ul style="list-style-type: none"> Is the sleep timer set? (See page 29.) Check the power control settings. (See page 14.) The unit's internal temperature has increased. Remove any objects blocking vent or clean.
<ul style="list-style-type: none"> No picture 	<ul style="list-style-type: none"> Is connection to other components correct? (See pages 24 to 25.) Is correct input signal source selected after connection? (See page 23.) Is the correct input selected? (See page 23.) Is picture adjustment correct? (See page 21.)
<ul style="list-style-type: none"> No sound 	<ul style="list-style-type: none"> Is the volume too low? (See page 17.) Is "OFF" selected in "SPEAKERS"? (See page 29.)

Troubleshooting-Digital broadcasting

This messages about reception of broadcasting

The example of an error message displayed on a screen	Possible Solution
<ul style="list-style-type: none"> DIGITAL CHANNEL SIGNAL STRENGTH IS LOW 	<ul style="list-style-type: none"> Check the antenna cable. Check that the antenna is correctly setup.
<ul style="list-style-type: none"> DIGITAL CHANNEL IS ENCRYPTED 	<ul style="list-style-type: none"> It is subscription channel. Contact the service provider.
<ul style="list-style-type: none"> AUDIO ONLY 	<ul style="list-style-type: none"> The channel has audio contents only.

Cautions regarding use in high and low temperature environments

- When the unit is used in a low temperature space (e.g. room, office), the picture may leave trails or appear slightly delayed. This is not a malfunction, and the unit will recover when the temperature returns to normal.
- Do not leave the unit in a hot or cold location. Also, do not leave the unit in a location exposed to direct sunlight or near a heater, as this may cause the cabinet to deform and the Liquid Crystal panel to malfunction.
Storage temperature: -4°F to +140°F (-20°C to +60°C)

Appendix

Specifications

Item		Model: LC-26D40U	Model: LC-32D40U	
LCD panel		26" Advanced Super View & BLACK TFT LCD	32" Advanced Super View & BLACK TFT LCD	
Number of dots		3,147,264 dots (1366 x 768 x 3 dots)		
TV Function	TV-standard (CCIR)	American TV Standard ATSC/NTSC System		
	Receiving Channel	VHF/UHF	VHF 2-13ch, UHF 14-69ch	
		CATV	1-125ch* (non-scrambled channel only.)	
		Digital Terrestrial Broadcast (8VSB)	2-69ch	
Audio multiplex		BTSC System		
Brightness		450cd/m ²		
Backlight		60,000 hours (at Backlight Standard position)		
Viewing angles		H : 176° V : 176°		
Audio out		10W x 2		
Terminals	Rear	INPUT 1	AV in, S-VIDEO in	
		INPUT 2	AV in, S-VIDEO in	
		INPUT 3	COMPONENT in, Audio in	
		INPUT 4	COMPONENT in, Audio in	
		INPUT 5	HDMI in with HDCP, Audio in	
		INPUT 6	HDMI in with HDCP	
		ANT/CABLE	75 Ω Unbalance, F Type x 1 for Analog (VHF/UHF/CATV) and Digital (AIR/CABLE)	
		DIGITAL AUDIO OUTPUT	Coaxial Digital audio output x 1 (PCM/Dolby Digital)	
		OUTPUT	Audio out	
OSD language		English/French/Spanish		
Power Requirement		AC 120 V, 60 Hz		
Power Consumption		145 W (Standby 1W)	170 W (Standby 1W)	
Weight	w/o stand	29.8 lbs./13.5 kg	37.5 lbs./17.0 kg	
	with stand	35.3 lbs./16.0 kg	43.0 lbs./19.5 kg	
Dimension (W ↘ H ↘ D)	w/o stand	26 ^{-7/8} x 4 ^{-1/2} x 19 ^{-5/8} inch	32 ^{5/16} x 4 ^{9/16} x 23 ^{5/16} inch	
	with stand	26 ^{-7/8} x 10 ^{13/16} x 21 ^{6/8} inch	32 ^{5/16} x 10 ^{13/16} x 25 ^{9/16} inch	
Accessories		Remote control unit (x1), AC cord (x1), "AAA" size battery (x2), Cable clamp (x1), Stand unit (x1), Operation manual (x1)		
Operating temperature		+32°F to +104°F (0°C to +40°C)		

- *Emergency alert messages via Cable are unreceivable.
- As part of policy of continuous improvement, SHARP reserves the right to make design and specification changes for product improvement without prior notice. The performance specification figures indicated are nominal values of production units. There may be some deviations from these values in individual units.

Optional accessories

The listed optional accessories are available for the LCD colour TV. Please purchase them at your nearest shop.

- Additional optional accessories may be available in near future. When purchasing, please read the newest catalogue for compatibility and check the availability.

No.	Part name	Part number
1	Wall mount bracket (for LC-26D40U)	AN-26AG1
2	Wall mount bracket (for LC-32D40U)	AN-37AG2

Dimensional drawings

LC-26D40U

Unit: inch/(mm)

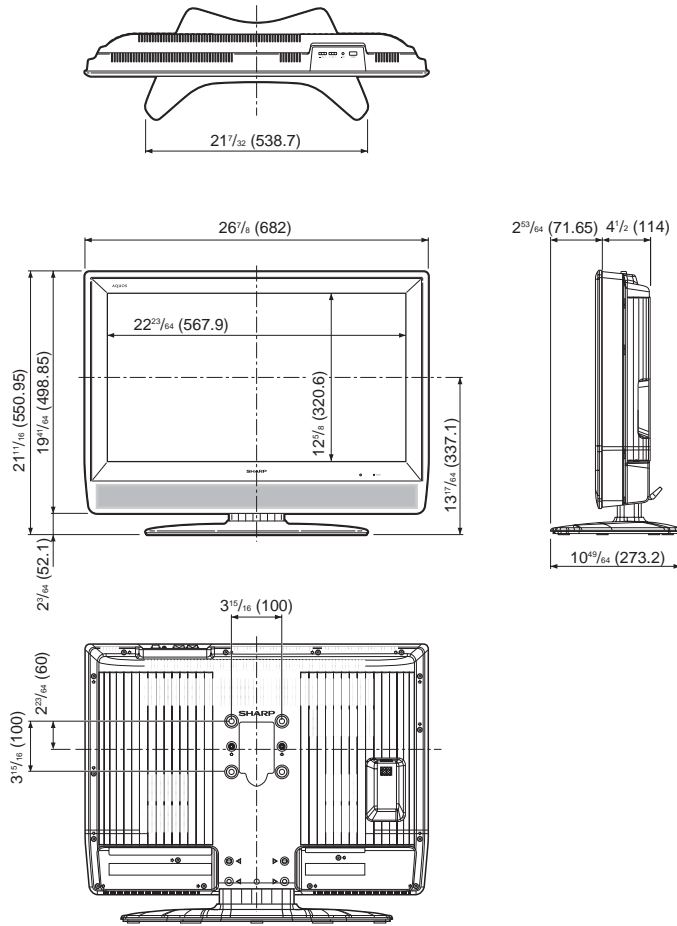

LC-32D40U

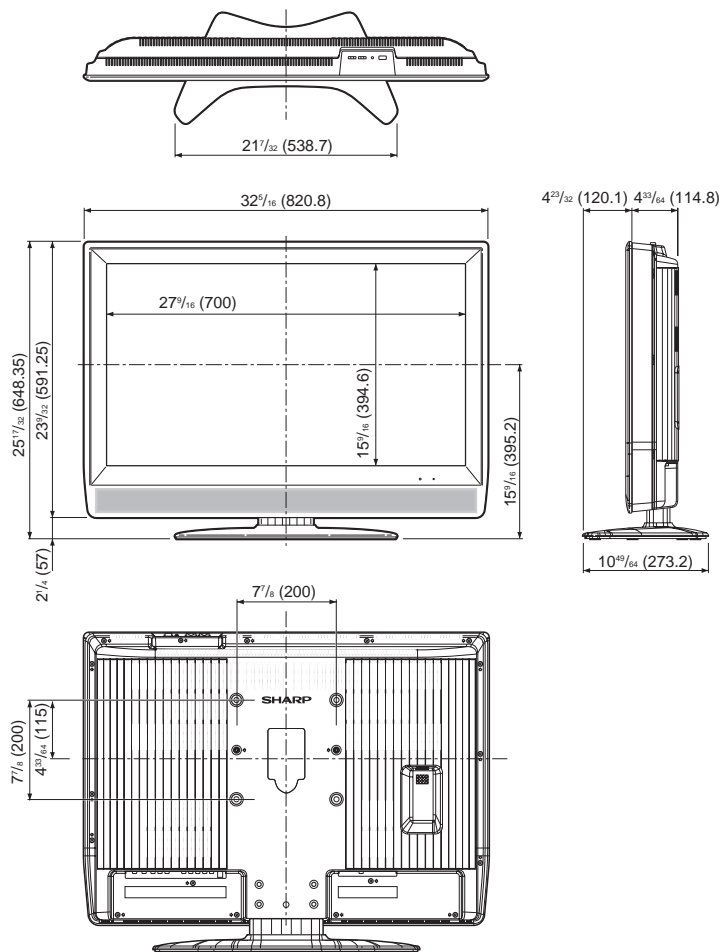

CLEARING THE PASSWORD

If you forget the password, clear the password using the following procedure.

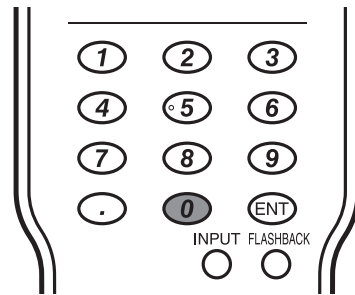
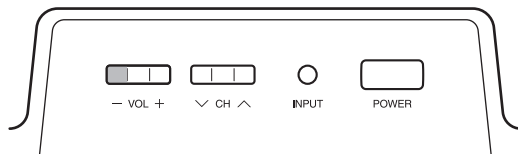

1

Press and hold both **VOL -** on the TV and **0** on the remote control simultaneously for a few seconds until  (LOCKS) menu appears on the screen.

2

Now the old password was cleared. You can set the new password. (See page 32.)

The password is

--	--	--	--	--

NOTE

- As a precautionary measure, make a note of your password above, cut it from this manual, and keep it in a safe place.

Calling for Service

For location of the nearest Sharp Authorized Service, or to obtain product literature, accessories, supplies, or customer assistance, please call 1-800-BE-SHARP.

LIMITED WARRANTY

CONSUMER LIMITED WARRANTY

SHARP ELECTRONICS CORPORATION warrants to the first consumer purchaser that this Sharp brand product (the "Product"), when shipped in its original container, will be free from defective workmanship and materials, and agrees that it will, at its option, either repair the defect or replace the defective Product or part thereof with a new or remanufactured equivalent at no charge to the purchaser for parts or labor for the period(s) set forth below.

This warranty does not apply to any appearance items of the Product nor to the additional excluded item(s) set forth below nor to any Product the exterior of which has been damaged or defaced, which has been subjected to improper voltage or other misuse, abnormal service or handling, or which has been altered or modified in design or construction.

In order to enforce the rights under this limited warranty, the purchaser should follow the steps set forth below and provide proof of purchase to the servicer.

The limited warranty described herein is in addition to whatever implied warranties may be granted to purchasers by law. ALL IMPLIED WARRANTIES INCLUDING THE WARRANTIES OF MERCHANTABILITY AND FITNESS FOR USE ARE LIMITED TO THE PERIOD(S) FROM THE DATE OF PURCHASE SET FORTH BELOW. Some states do not allow limitations on how long an implied warranty lasts, so the above limitation may not apply to you.

Neither the sales personnel of the seller nor any other person is authorized to make any warranties other than those described herein, or to extend the duration of any warranties beyond the time period described herein on behalf of Sharp.

The warranties described herein shall be the sole and exclusive warranties granted by Sharp and shall be the sole and exclusive remedy available to the purchaser. Correction of defects, in the manner and for the period of time described herein, shall constitute complete fulfillment of all liabilities and responsibilities of Sharp to the purchaser with respect to the Product, and shall constitute full satisfaction of all claims, whether based on contract, negligence, strict liability or otherwise. In no event shall Sharp be liable, or in any way responsible, for any damages or defects in the Product which were caused by repairs or attempted repairs performed by anyone other than an authorized servicer. Nor shall Sharp be liable or in any way responsible for any incidental or consequential economic or property damage. Some states do not allow the exclusion of incidental or consequential damages, so the above exclusion may not apply to you.

THIS WARRANTY GIVES YOU SPECIFIC LEGAL RIGHTS. YOU MAY ALSO HAVE OTHER RIGHTS WHICH VARY FROM STATE TO STATE.

Model Specific Section

Your Product Model Number & Description:

LC-26D40U •LC-32D40U LCD Color Television
(Be sure to have this information available when you need service for your Product.)

Warranty Period for this Product:

One (1) year parts and labor from the date of purchase.

Additional Item(s) Excluded from Warranty Coverage (if any):

Non-rechargeable batteries.

Where to Obtain Service:

From a Sharp Authorized Servicer located in the United States. To find the location of the nearest Sharp Authorized Servicer, call Sharp toll free at 1-800-BE-SHARP.

What to do to Obtain Service:

Contact your Sharp Authorized Servicer to obtain in-home service for this Product. The Servicer will come to your home and if it is necessary to remove the Product, the Servicer will reinstall it. Be sure to have **Proof of Purchase** available.

TO OBTAIN PRODUCT INFORMATION, CALL 1-800-BE-SHARP OR VISIT www.sharpusa.com

SHARP®

SHARP ELECTRONICS CORPORATION

Sharp Plaza, Mahwah, New Jersey 07430-2135

SHARP CORPORATION