

LC-10A2U

LCD COLOR TELEVISION

ENGLISH

OPERATION MANUAL

Important Information

WARNING: TO REDUCE THE RISK OF FIRE OR ELECTRIC SHOCK, DO NOT EXPOSE THIS PRODUCT TO RAIN OR MOISTURE.

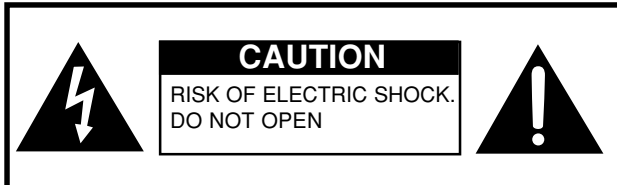

CAUTION: TO REDUCE THE RISK OF ELECTRIC SHOCK, DO NOT REMOVE COVER (OR BACK). NO USER-SERVICEABLE PARTS INSIDE. REFER SERVICING TO QUALIFIED SERVICE PERSONNEL.



The lightning flash with arrow-head symbol, within an equilateral triangle, is intended to alert the user to the presence of uninsulated "dangerous voltage" within the product's enclosure that may be of sufficient magnitude to constitute a risk of electric shock to persons.



The exclamation point within a triangle is intended to alert the user to the presence of important operating and maintenance (servicing) instructions in the literature accompanying the product.

WARNING: FCC Regulations state that any unauthorized changes or modifications to this equipment not expressly approved by the manufacturer could void the user's authority to operate this equipment.

U.S.A. ONLY

CAUTION: TO PREVENT ELECTRIC SHOCK, MATCH WIDE BLADE OF PLUG TO WIDE SLOT, FULLY INSERT.

"Note to CATV system installer: This reminder is provided to call the CATV system installer's attention to Article 820-40 of the National Electrical Code that provides guidelines for proper grounding and, in particular, specifies that the cable ground shall be connected to the grounding system of the building, as close to the point of cable entry as practical."

IMPORTANT:

To aid reporting in case of loss or theft, please record the TV's model and serial numbers in the space provided. The numbers are located at the rear of the TV.

Model No.:

Serial No.:

U.S.A. ONLY

CONTENTS

	Page
DEAR SHARP CUSTOMER	5
IMPORTANT SAFETY PRECAUTIONS	5,6
SUPPLIED ACCESSORIES	7
PREPARATION	8-10
Preparing and Using the Remote Control	8
Batteries for Remote Control	8
Power Connection	9
Antenna Connection	9,10
FRONT AND REAR CONTROL OPTIONS	11
REMOTE CONTROL	13
BASIC OPERATION	13-16
Turning on POWER	14
Switching TV/VIDEO AV1/AV2/TV Mode	14
Sound Volume	15
ON/OFF Standby	15
Changing the Channels	16
SELECTING THE MENU ITEMS	17
Selecting a Menu Item	17
EZ SETUP DURING FIRST POWER ON	18
ADJUSTMENT	19-26
Adjusting the LANGUAGE Settings	19
Adjusting the SLEEP TIMER Settings	19
Adjusting the VIDEO ADJUST Settings	20,21
Adjusting the PRESET Settings	22
SETUP	23-25
Adjusting the BLUE SCREEN Settings	26
LISTENING WITH A HEADPHONE	27
EXAMPLE OF APPLICATION	27
CONNECTING WITH EXTERNAL DEVICES	28-30
TROUBLESHOOTING	31,32
SPECIFICATIONS	33

DEAR SHARP CUSTOMER

Thank you for your purchase of the Sharp LCD Color TV product. To ensure safety and many years of trouble-free operation of your product, please read the Safety Precautions carefully before using this product.

IMPORTANT SAFETY PRECAUTIONS

Electricity is used to perform many useful functions, but it can also cause personal injuries and property damage if improperly handled. This product has been engineered and manufactured with the highest priority on safety. However, improper use can result in electric shock and/or fire. In order to prevent potential danger, please observe the following instructions when installing, operating and cleaning the product. To ensure your safety and prolong the service life of your LCD color TV product, please read the following precautions carefully before using the product.

1. Read instructions—All operating instructions must be read and understood before the product is operated.
2. Keep this manual in a safe place—These safety and operating instructions must be kept in a safe place for future reference.
3. Observe warnings—All warnings on the product and in the instructions must be observed closely.
4. Follow instructions—All operating instructions must be followed.
5. Cleaning—Unplug the power cord from the AC outlet before cleaning the product. Use a damp cloth to clean the product. Do not use liquid cleaners or aerosol cleaners.
6. Attachments—Do not use attachments not recommended by the manufacturer. Use of inadequate attachments can result in accidents.
7. Water and moisture—Do not use the product near water, such as bathtub, washbasin, kitchen sink and laundry tub, swimming pool and in a wet basement.
8. Stand—Do not place the product on an unstable cart, stand, tripod or table. Placing the product on an unstable base can cause the product to fall, resulting in serious personal injuries as well as damage to the product. Use only a cart, stand, tripod, bracket or table recommended by the manufacturer or sold with the product. When mounting the product on a wall, be sure to follow the manufacturer's instructions. Use only the mounting hardware recommended by the manufacturer.
9. When relocating the product placed on a cart, it must be moved with utmost care. Sudden stops, excessive force and uneven floor surface can cause the product to fall from the cart.
10. Ventilation—The vents and other openings in the cabinet are designed for ventilation. Do not cover or block these vents and openings since insufficient ventilation can cause overheating and/or shorten the life of the product. Do not place the product on a bed, sofa, rug or other similar surface, since they can block ventilation openings. This product is not designed for built-in installation; do not place the product in an enclosed place such as a bookcase or rack, unless proper ventilation is provided or the manufacturer's instructions are followed.
11. Power source—This product must operate on a power source specified on the specification label. If you are not sure of the type of power supply used in your home, consult your dealer or local power company. For units designed to operate on batteries or another power source, refer to the operating instructions.
12. Power cord protection—The power cords must be routed properly to prevent people from stepping on them or objects from resting on them. Check the cords at the plugs and product.
13. If the AC adapter is misplaced or needs to be replaced, obtain the same type of adapter from a SHARP service center or your dealer.
14. The LCD panel used in this product is made of glass. Therefore, it can break when the product is dropped or applied with impact. Be careful not to be injured by broken glass pieces in case the LCD panel breaks.
15. Overloading—Do not overload AC outlets or extension cords. Overloading can cause fire or electric shock.
16. Entering of objects and liquids—Never insert an object into the product through vents or openings. High voltage flows in the product, and inserting an object can cause electric shock and/or short internal parts. For the same reason, do not spill water or liquid on the product.



IMPORTANT SAFETY PRECAUTIONS (Continued)

17. Servicing—Do not attempt to service the product yourself. Removing covers can expose you to high voltage and other dangerous conditions. Request a qualified service person to perform servicing.
18. Repair—If any of the following conditions occurs, unplug the power cord from the AC outlet, and request a qualified service person to perform repairs.
 - a. When the power cord or plug is damaged.
 - b. When a liquid was spilled on the product or when objects have fallen into the product.
 - c. When the product has been exposed to rain or water.
 - d. When the product does not operate properly as described in the operating instructions.

Do not touch the controls other than those described in the operating instructions. Improper adjustment of controls not described in the instructions can cause damage, which often requires extensive adjustment work by a qualified technician.
 - e. When the product has been dropped or damaged.
 - f. When the product displays an abnormal condition. Any noticeable abnormality in the product indicates that the product needs servicing.
19. Replacement parts—In case the product needs replacement parts, make sure that the service person uses replacement parts specified by the manufacturer, or those with the same characteristics and performance as the original parts. Use of unauthorized parts can result in fire, electric shock and/or other danger.
20. Safety checks—Upon completion of service or repair work, request the service technician to perform safety checks to ensure that the product is in proper operating condition.
21. Wall or ceiling mounting—When mounting the product on a wall or ceiling, be sure to install the product according to the method recommended by the manufacturer.
22. Heat sources—Keep the product away from heat sources such as radiators, heaters, stoves and other heat-generating products (including amplifiers).
23. Polarization—This AC adapter may be equipped with a polarized alternating current line plug (a plug having one blade wider than the other). This plug will fit into the power outlet only one way. This is a safety feature. If you are unable to insert the plug fully into the outlet, try reversing the plug. If the plug should still fail to fit, contact your electrician to replace your obsolete outlet. Do not defeat the safety purpose of the polarized plug.

The LCD panel is a very high technology product with 921,600 thin film transistors, giving you fine picture details.

Occasionally, a few non-active pixels may appear on the screen as a fixed point of blue, green or red.

Please note that this does not affect the performance of your product.

SUPPLIED ACCESSORIES

Make sure the following accessories are provided with the product.

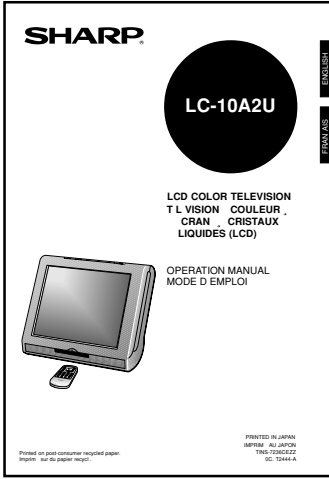
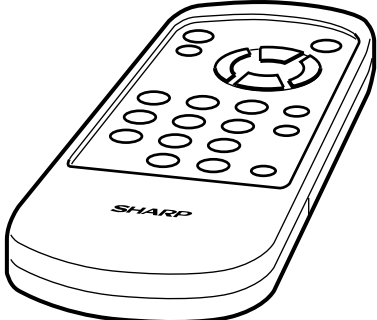
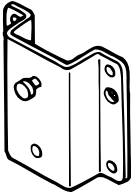
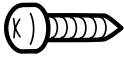
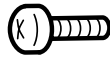
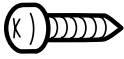
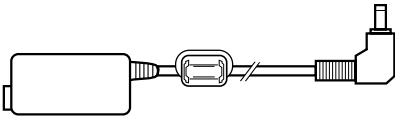
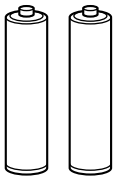
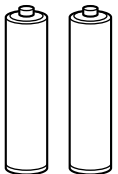
<p>Operation Manual (×1)</p>  <p>TINS-7236CEZZ</p>		<p>Wireless Remote Control (×1)</p>  <p>RRMCG1559CESA</p>	
<p>Wall Mount Bracket (×1)</p> 	<p>Antenna Cable</p>  <p>QCNW-5730CEZZ</p>	<p>AC Cord</p>  <p>QACCD3093CEZZ</p>	
<p>Wall Mount Bracket Screws (×4)</p> 	<p>AC Adapter (×1)</p>  <p>UADP-0211CEZZ</p>	<p>Size AAA Dry Battery (×2)</p>  <p>UBATU0026GEZZ</p>	
<p>Fixed Screw for Set Stand (×1)</p>  <p>LANGU9053CE01</p>			

PREPARATION

Preparing and Using the Remote Control

- Use the remote control by pointing it towards the remote sensor window. Objects between the remote control and sensor window may prevent proper operation.

Cautions regarding use of remote control

- Do not expose the remote control to shock. In addition, do not expose the remote control to liquids, and do not place in an area with high humidity.
- Do not install or place the remote control under direct sunlight. The heat may cause deformation of the unit.
- The remote control may not work properly if the remote sensor window of the main unit is under direct sunlight or strong lighting. In such case, change the angle of the lighting or LCD TV set, or operate the remote control closer to the remote sensor window.

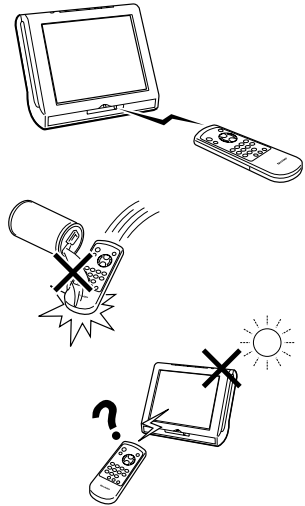

Batteries for Remote Control

If the remote control fails to operate LCD color TV functions, replace the batteries in the remote control.

- 1** Open the battery cover.

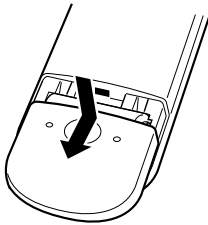

- Slide the cover while pressing down.

- 2** Insert batteries (two size-AAA batteries, supplied with product).

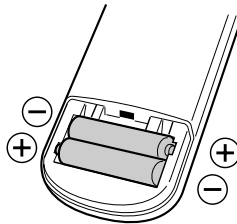

- Place batteries with their terminals corresponding to the (+) and (-) indications in the battery compartment.

- 3** Close the battery cover.

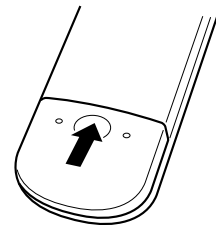

⚠ Caution!

Cautions regarding batteries

Improper use of batteries can result in a leakage of chemicals and/or explosion. Be sure to follow the instructions below.

- Place batteries with their terminals corresponding to the (+) and (-) indications.
- Different types of batteries have different characteristics. Do not mix batteries of different types.
- Do not mix old and new batteries. Mixing old and new batteries can shorten the life of new batteries and/or cause old batteries to leak chemicals.
- Remove batteries as soon as they are non-operable. Chemicals that leak from batteries can cause a rash. If chemical leakage is found, wipe with a cloth.
- The batteries supplied with the product may have a shorter life expectancy due to storage conditions.
- If the remote control is not used for an extended period of time, remove batteries from the remote control.

PREPARATION (Continued)

Power Connection

Plug into AC outlet.

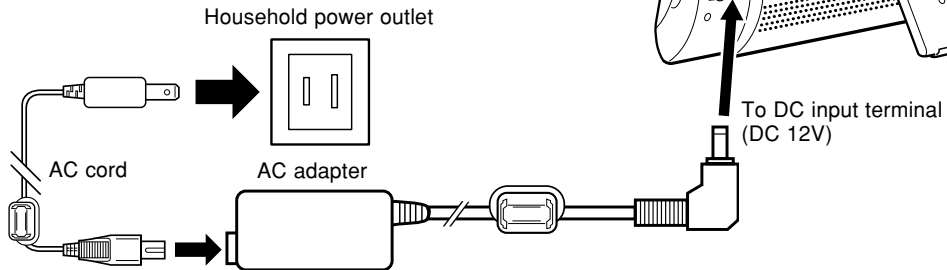

Notes:

- Use a commercially available AC plug adapter, if necessary, depending on the design of the wall socket.
- Always turn the main power switch of the LCD TV set to OFF when connecting the AC adapter.
- Always unplug the AC adapter from the product and power outlet when not using for long periods of time.

Antenna Connection

CABLE TV (CATV) CONNECTION

- A 75 ohm coaxial cable connector is built into the set for easy hookup. When connecting the 75 ohm coaxial cable to the set, screw the 75 ohm cable to the COAXIAL CABLE CONNECTOR.
- Some cable TV companies offer "premium pay channels". Since the signals of these premium pay channels are scrambled, a cable TV converter/descrambler is generally provided to the subscriber by the cable TV company. This converter/descrambler is necessary for normal viewing of the scrambled channels. (Place your TV on channel 3 or 4, typically one of these channels is used. If this is unknown, consult your cable TV company.) For more specific instructions on installing cable TV, consult your cable TV company. One possible method of utilizing the converter/descrambler provided by your cable TV company is explained below. Please note: RF switch equipped with position A/B (not provided) is required.

"A" position on the RF switch (not supplied) : You can view all unscrambled channels using the TV's channel keys.

"B" position on the RF switch (not supplied) : You can view the scrambled channels via the converter/descrambler using the converter's channel keys.

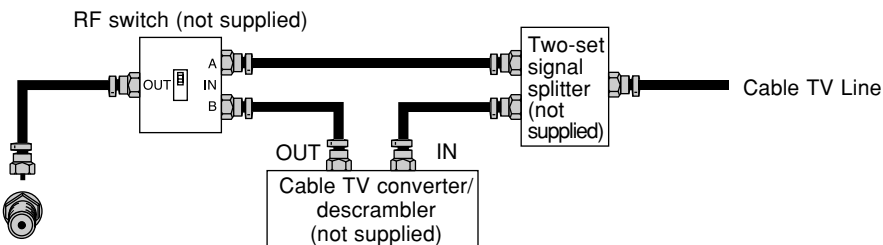

Note:

- Consult your SHARP Dealer or Service Center for the type of splitter, RF switch or combiner that might be required.

PREPARATION (Continued)

Antenna Connections

Antennas

■ The antenna requirements for good color television reception are more important than those for black & white television reception. For this reason, a good quality outdoor antenna is strongly recommended. The following is a brief explanation of the type of connections that are provided with the various antenna systems:

1. A 75 ohm system is generally a round cable with F-type connector that can easily be attached to a terminal without tools (not supplied).
2. A 300 ohm system is a flat "twin-lead" cable that can be attached to a 75 ohm terminal through a 300-75 ohm ADAPTOR (not supplied).

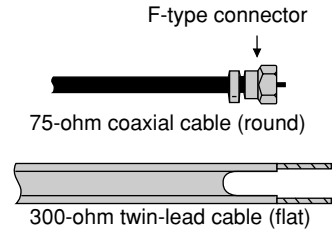

OUTDOOR ANTENNA CONNECTION

- Use one of the following two diagrams if you connect an outdoor antenna.
 - A: Using a VHF/UHF combination outdoor antenna.
 - B: Using separate VHF and/or UHF outdoor antenna.
- Connect an outdoor antenna cable lead-in to the COAXIAL CABLE CONNECTOR on the rear of the TV set.

A. Combination VHF/UHF Antennas

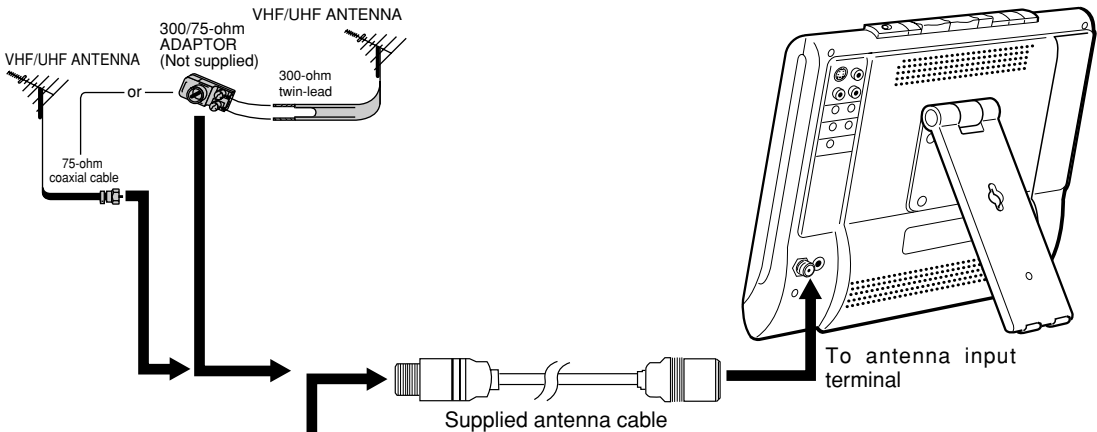

B. Separate VHF/UHF Antenna

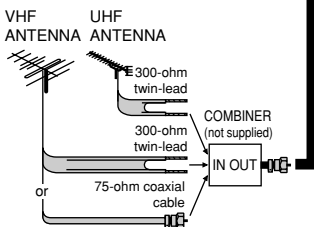

FRONT AND REAR CONTROL OPTIONS

Main unit (front view)

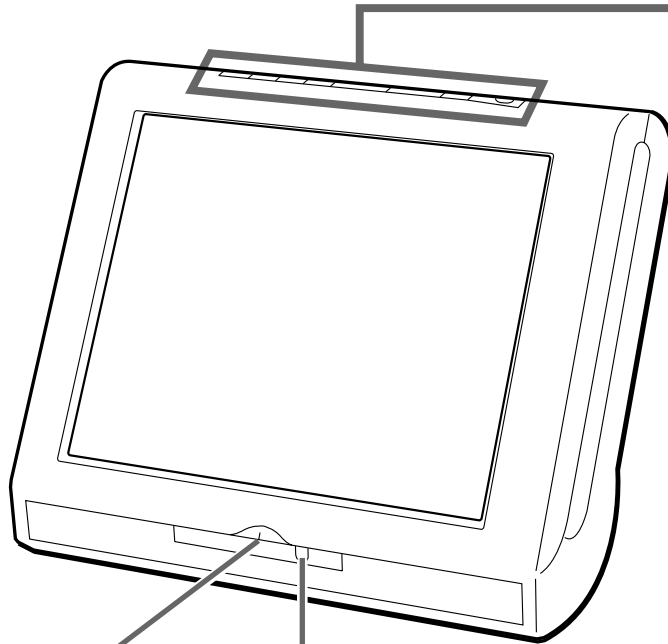

Power/standby indicator

A green indicator lights when the power is on and a red indicator lights when in the standby mode (the indicator will not light when the power is off).

Remote sensor window

(The actual location is not visible)

Top control panel

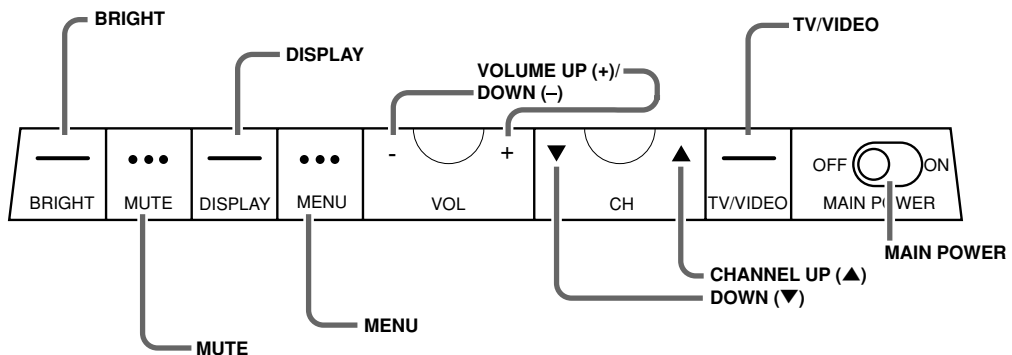

- The **MUTE**, **DISPLAY**, **MENU**, **VOLUME UP(+)/DOWN(-)**, **CHANNEL UP(▲)/DOWN(▼)**, and **TV/VIDEO** buttons provide the same functions as the buttons on the remote control. (The **MENU** button has a slightly different function from the remote control button.)

FRONT AND REAR CONTROL OPTIONS (Continued)

Main unit (rear view)

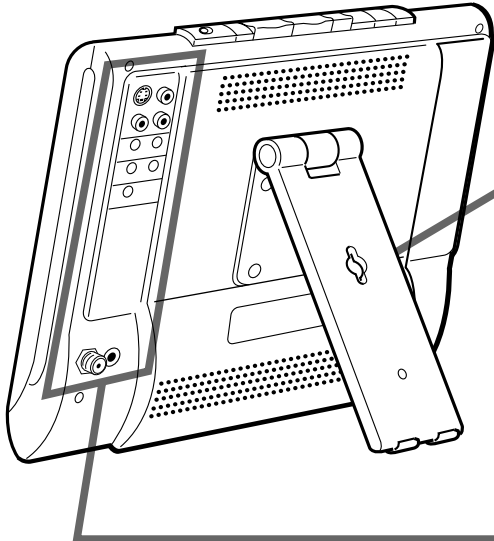

Adjust the set stand to an angle so that the screen is easily visible. The set stand can be opened up to 80°.

Rear terminal section

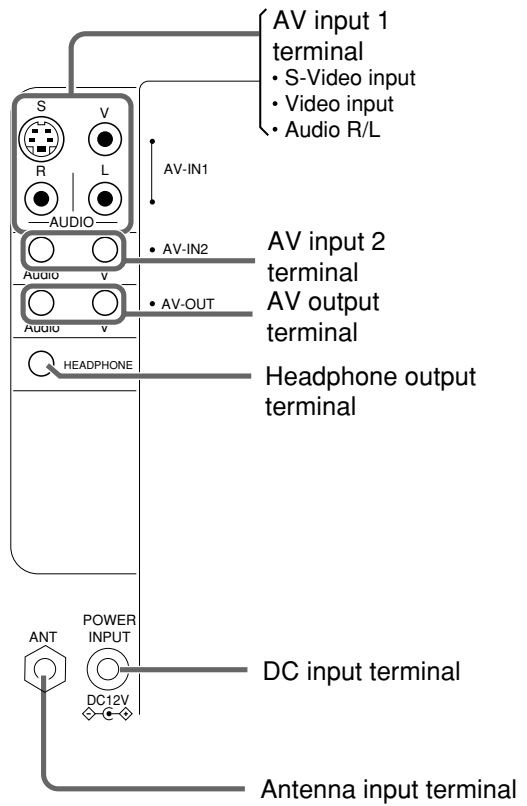

REMOTE CONTROL/BASIC OPERATION

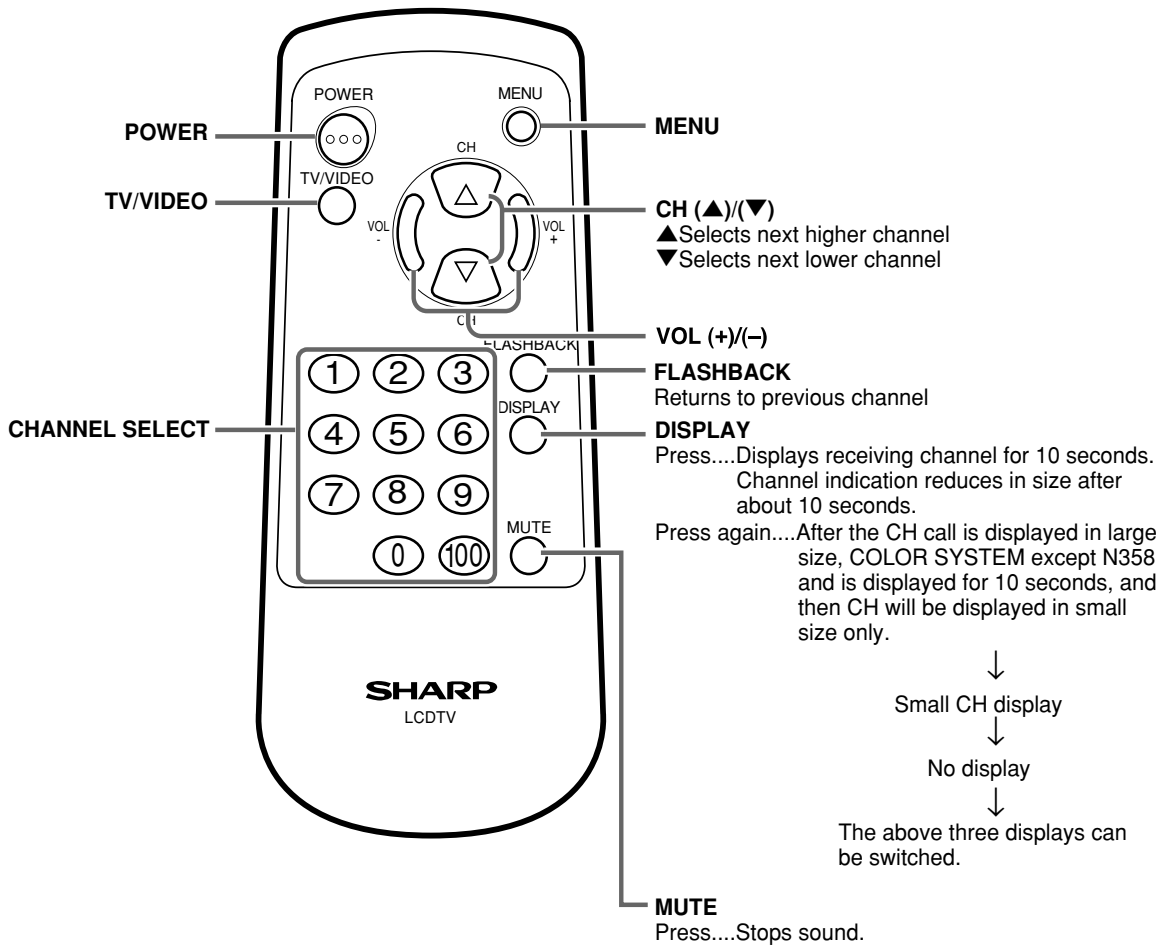

BASIC OPERATION

This product is factory set to comply with the TV broadcasting system in the United States. For Brazil, Argentina and Uruguay, set the color system according to the country before using this product by following the table below.

The VIDEO INPUT mode is compatible with color systems worldwide and is automatically set.

Country	TV broadcasting system	Factory setting of color system		User setting
		TV	Video	TV
U.S.A	Color: NTSC TV ch: US ch	NTSC (N358) US ch	World Multi Auto System	Not required or N/A
Canada, Mexico, Latin America	Color: NTSC TV ch: US ch	NTSC (N358) US ch	World Multi Auto System	Not required or N/A
Brazil	Color: PAL-M TV ch: US ch	NTSC (N358) US ch	World Multi Auto System	Set color system to PAL-M (see page 21)
Argentina, Uruguay	Color: PAL-N TV ch: US ch	NTSC (N358) US ch	World Multi Auto System	Set color system to PAL-N (see page 21)

* The World Multi Auto System is compatible with all color systems indicated below.

- ① PAL-STANDARD
- ② PAL-M
- ③ PAL-N
- ④ NTSC
- ⑤ SECAM

BASIC OPERATION (Continued)

Turning on POWER

Control section of main unit

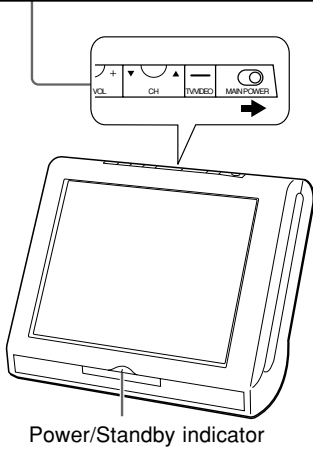

- 1 Slide the **MAIN POWER** switch, located on the upper side of the main unit to ON.
- 2 The Power indicator instantaneously changes from red to green and the main unit is turned on.

Note:

Input mode indication disappears after several seconds.

▼ ON-screen display

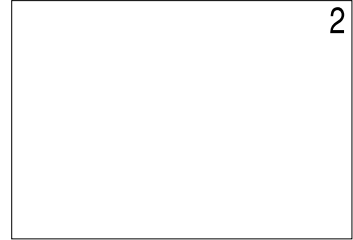

Switching TV/VIDEO AV1/AV2/TV Mode

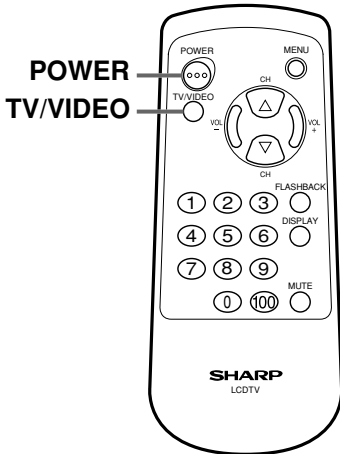

- 1 Turn on the power of the connected video equipment.
- 2 Press the **TV/VIDEO** and select the applicable input source. The screen displays AV1, AV2 or TV mode at the upper right corner each time **TV/VIDEO** is pressed.

Notes:

- AV input mode indication remains for five seconds.
- AV1: Video equipment connected to the AV1 input terminals. S-video input terminals are additionally provided for the AV1 input. If both S-video and normal video terminals are connected with cables, the S-video input terminals take precedence.

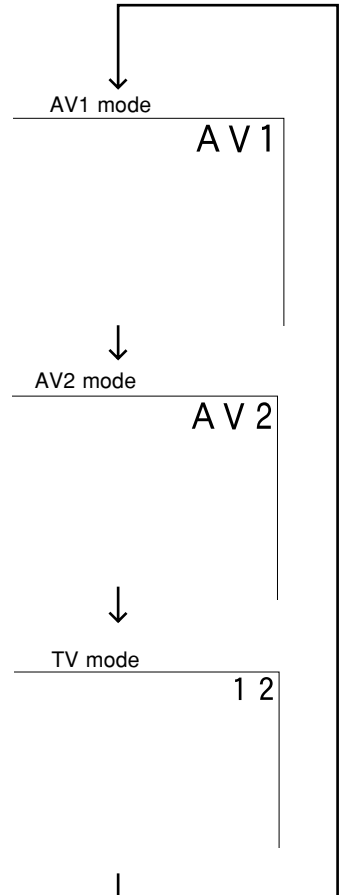

BASIC OPERATION (Continued)

Sound Volume

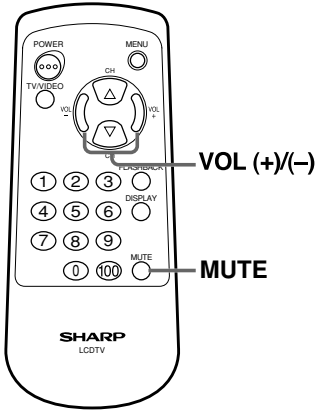

1 Press the **VOL (+)** to increase sound volume. The segment of indicator increases.



2 Press the **VOL (-)** to decrease sound volume. The segment of indicator decreases.



To mute sound

1 Press the **MUTE** to temporarily turn off the sound. Screen display MUTE MARK.



2 Press the **MUTE** or **VOL (+)/(-)** to turn the sound back to the previous level. The following buttons can also be used to cancel MUTE: **CH, TV/VIDEO, FLASHBACK, POWER ON/OFF, BRIGHT.**



ON/OFF Standby

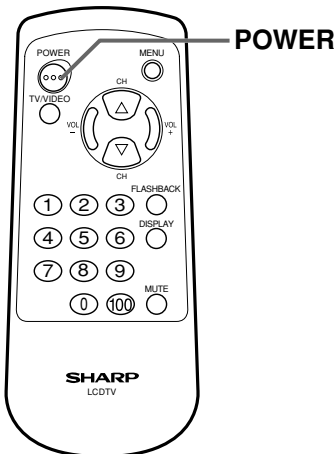

To turn off the LCD TV

Press the **POWER** on the remote control. The Power indicator will turn red.

To turn the LCD TV back on

Press the **POWER** again. The Power indicator will turn green.

BASIC OPERATION (Continued)

Changing the Channels

Changing channels using the **CHANNEL SELECT** on the remote control

- To handle the increasing number of channels available, this LCD TV set allows you to select up to 125 positions (Channels 1 to 125). One-digit, two-digit and three-digit methods of selection can be used. Follow the procedure shown below to select channels.

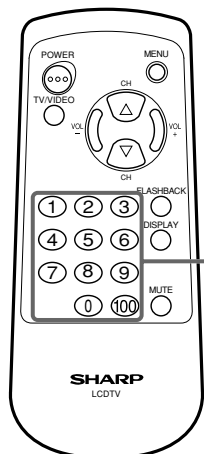

CHANNEL SELECT

To select a one-digit channel (e.g., Channel 5):

Basically, the 2-digit entry is used.

- 1 Press the 0 button.
- 2 Press the 5 button.

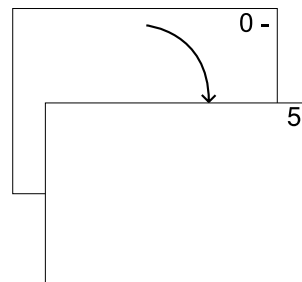

To select a three-digit channel (e.g., Channel 115):

- 1 Press the 100 button.
- 2 Press the 1 button.
- 3 Press the 5 button.

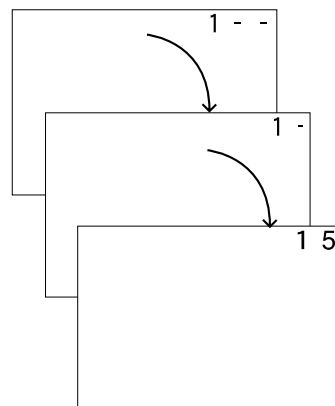

Note:

- Complete this procedure within 3 seconds, otherwise the selection will not be made.

Changing channels with the CH (▲)/(▼) on the remote control.

Press the **CH (▲)** and the channels change in the order shown below:

1 → 2 → 3 → ... → 125 → 1 → 2 → 3 → ...

Press the **CH (▼)** button and the channels change in the order shown below:

3 → 2 → 1 → ... → 125 → ... → 3 → 2 → 1 → ...

Air **CH (▲)** 2 → 3 → ... → 68 → 69 → 2 → 3 → ...

CH (▼) 3 → 2 → 69 → 68 → ... → 3 → 2 → ...

STD **CH (▲)** 2 → 3 → ... → 124 → 125 → 2 → 3 → ...

CH (▼) 3 → 2 → ... → 125 → 124 → ... → 3 → 2 → ...

HRC **CH (▲)** 1 → 2 → 3 → ... → 124 → 125 → 1 → 2 → ...

CH (▼) 1 → 125 → 124 → ... → 3 → 2 → 1 → ...

IRC **CH (▲)** 1 → 2 → 3 → ... → 124 → 125 → 1 → 2 → ...

CH (▼) 2 → 1 → 125 → 124 → ... → 3 → 2 → 1 → ...

SELECTING THE MENU ITEMS

Selecting a Menu Item

- This LCD TV set allows you to adjust the picture and sound, and set the channels and other features using the On Screen Display. Select the desired menu item by following the steps below and then refer to the indicated page for details.

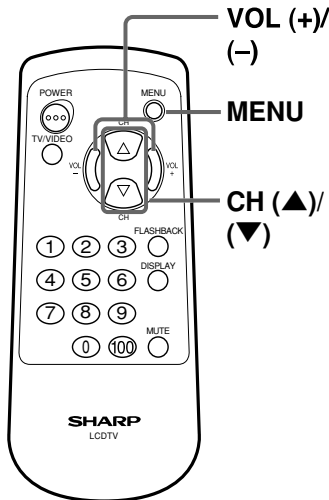

- 1 Press the **MENU** to display the MENU screen.
- 2 Press the **CH (▲)/(▼)** to select the desired menu item.
 - The "▶" mark moves up or down.
 - The "▶" mark indicates the selected menu item.
- 3 Press the **VOL (+)/(-)** to enter.
- 4 Press the **MENU** to exit.

```

MENU
▶ SLEEP TIMER
VIDEO ADJUST
PRESET
SET UP
    
```

SELECT:▲CH▼ ENTER:-VOL+ EXIT:MENU

SLEEP TIMER
menu ----- Page 19

```

SLEEP TIMER
--- REMAIN
    
```

ADJUST:-VOL+ E

VIDEO ADJUST menu
(TV mode) ----- Page 20, 21

```

VIDEO ADJUST(TV)
PICTURE [ 0 ]
TINT [ 0 ]
COLOR [ 0 ]
BLACK LEVEL [ 0 ]
SHARPNESS [ 0 ]
COLOR SYSTEM [ N358 ]
RESET
    
```

SELECT:▲CH▼ ENTER:-VOL+ EXIT:MENU

VIDEO ADJUST menu
(AV mode) ----- Page 20, 21

```

VIDEO ADJUST(AV)
PICTURE [ 30 ]
TINT [ 0 ]
▶ COLOR [ 0 ]
BLACK LEVEL [ 0 ]
RED-BLUE [ 0 ]
GREEN [ 0 ]
COLOR SYSTEM [ AUTO ]
RESET
    
```

SELECT:▲CH▼ ENTER:-VOL+ EXIT:MENU

PRESET menu ----- Page 22

```

PRESET
▶ BRIGHTNESS [ BRIGHT ]
AUTO POWER OFF [ OFF ]
UPSIDE [ NORMAL ]
RIGHT/LEFT [ NORMAL ]
    
```

SELECT:▲CH▼ ADJUST:-VOL+ E

SETUP
menu ----- Page 23, 24, 25

```

SET UP
▶ BLUE SCREEN [ OFF ]
LANGUAGE
CH-SETTING
    
```

SELECT:▲CH▼ ADJUST:-VOL+ E

Notes:

- The TINT display only appears when the color system sets N358 or N443 or AUTO in the NTSC mode.
- The displayed items differ depending on the setting conditions.
- The selected item changes to yellow.
- Items in purple cannot be selected.
- TV mode
 - This product is factory set to comply with the color system (NTSC-N358) in the United States. For Brazil (PAL-M), Argentina (PAL-N) and Uruguay (PAL-N), set the color system before using this product.
- COLOR SYSTEM
 - Set the system to AUTO for normal reception. The AUTO mode automatically detects the receiving signal system and changes the reception system of the set.
 - When the picture or sound is not stable, switching to an appropriate system may improve the picture or sound quality.

* The screen indications shown above are larger than actual for easy reading.

EZ SETUP DURING FIRST POWER ON

- When you turn on the LCD TV for the first time, it will automatically memorize the broadcasting channels.
Please perform the following instructions before you press the power button.
 - (1) Insert the batteries into the remote control. (See page 8)
 - (2) Connect the antenna cable to the TV set. (See page 9 ~ 10)
 - (3) Plug in the AC adapter to the wall outlet.

Control section of main unit

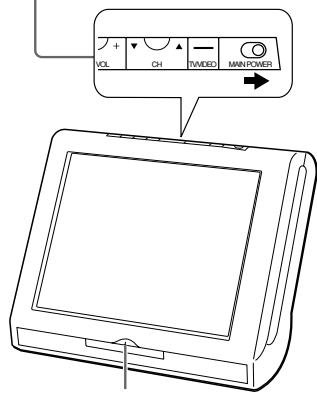

Power/Standby indicator

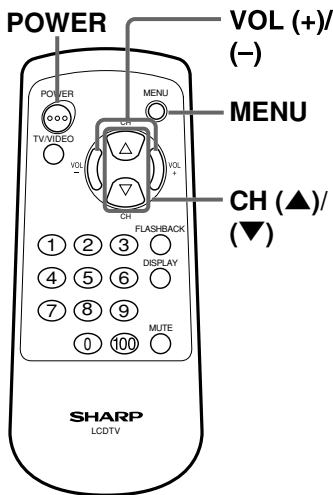

1 Slide the **MAIN POWER** button on the LCD TV set or on the Remote Control to turn on the LCD TV. The **SELECT LANGUAGE** mode will be displayed.

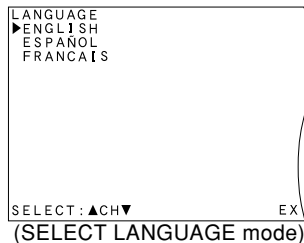

2 Press **CH (▲)/(▼)** to select "ENGLISH", "SPANISH (ESPAÑOL)" or "FRENCH (FRANÇAIS)".

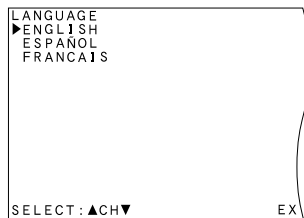

3 Press **VOL (+)/(-)** to display **EZ SETUP** mode.

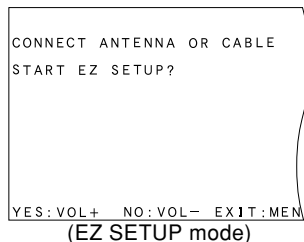

4 Press **VOL (+)**.

The tuner will automatically search for the broadcasting and cable TV channels. (The CH No. will automatically increase when it appears.)

If you want to stop the **EZ SETUP** process once it has started, press **VOL (-)** and it will be canceled.

If you want to **SETUP** again, please refer to page 22 on **SETUP**. Press **VOL (-)** to cancel **EZ SETUP**.

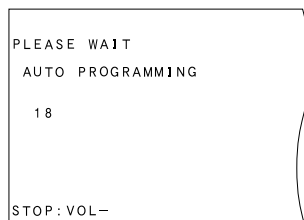

5 Once **EZ SETUP** is completed, the smallest channel number memorized will be displayed.

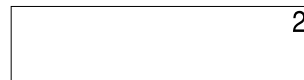

Notes:

- If **EZ SETUP** does not memorize all the channels in your region, please refer to page 23 for more information on manual memorizing the channels using **CHANNEL SETTING**.
- It may be difficult to **PRESET** when the broadcasting signals are weak, the channel cycle frequency is incorrect or the frequency jamming is occurring around the area. Please refer to pages 23 ~ 24 for more information on manual memorizing the channels using **CHANNEL SETTING**.

ADJUSTMENT

Adjusting the LANGUAGE Settings

The language for the ON SCREEN DISPLAY can be ENGLISH, SPANISH or FRENCH.
Setting the ON SCREEN DISPLAY Language.

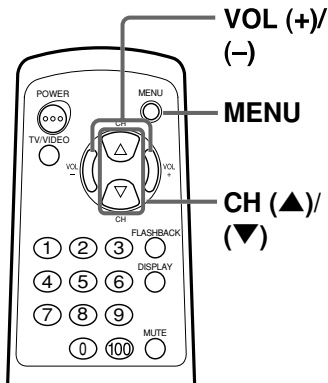

- 1 Press the **MENU** to display the MENU screen.
- 2 Press the **CH (▲)/(▼)** to move the "▶" mark to "SETUP".
- 3 Press **VOL (+)/(-)** to display SETUP mode, then press **CH (▲)/(▼)** to move the "▶" mark to "LANGUAGE".
- 4 Press **VOL (+)/(-)** to display LANGUAGE change mode.
- 5 Press the **CH (▲)/(▼)** to select "ENGLISH", "SPANISH (ESPAÑOL)" or "FRENCH (FRANÇAIS)".
- 6 Press **MENU** to exit.

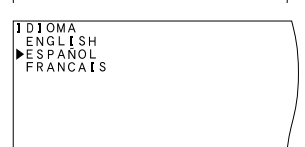
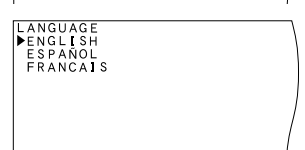
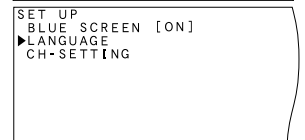
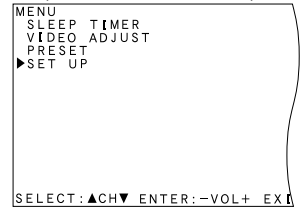
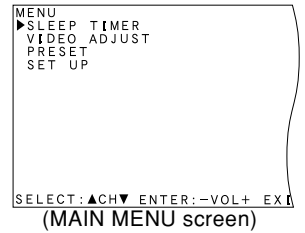

Adjusting the SLEEP TIMER Settings

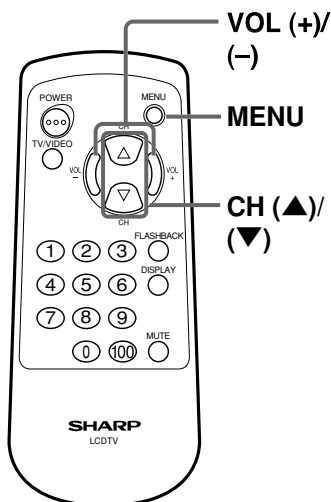

- 1 Press the **MENU** to display the MENU screen.
- 2 Press the **CH (▲)/(▼)** to move the cursor to SLEEP TIMER.
- 3 Press the **VOL (+)/(-)** to display SLEEP TIMER screen.
- 4 Press the **VOL (+)/(-)** to set the sleep timer (in minutes).

The setting can be set in increment of 30 minutes and in the range between 30 and 120 minutes.

The setting is turned off when --- is displayed.

- 5 Press the **MENU** to return to the main screen.

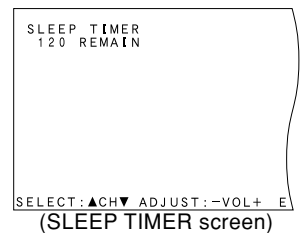
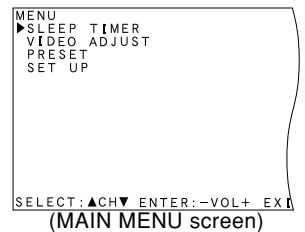

ADJUSTMENT (Continued)

Adjusting the VIDEO ADJUST Settings

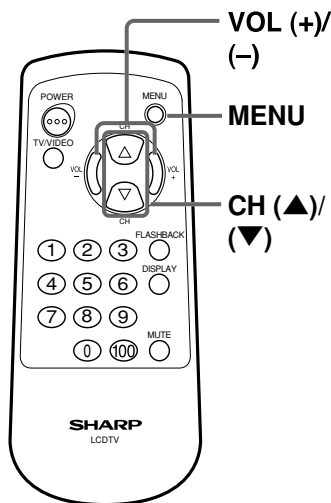

1 Press the **MENU** to display the MENU screen.

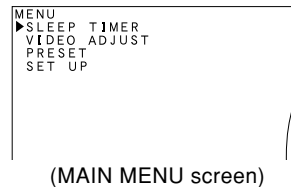

2 Press the **CH (▲)/(▼)** to move the cursor to VIDEO ADJUST.

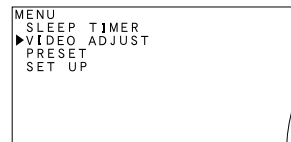

3 Press the **VOL (+)/(-)** to display the VIDEO ADJUST Menu screen.

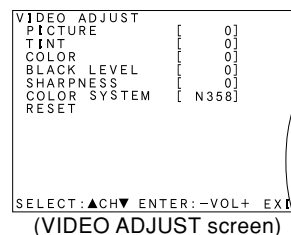

4 Press the **CH (▲)/(▼)** to move the cursor and select the desired adjustment item. All of adjustment item is shown in the diagram on page 21.

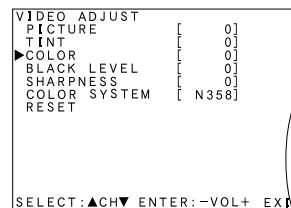

5 Press the **VOL (+)/(-)** to display the screen for the selected adjustment item.

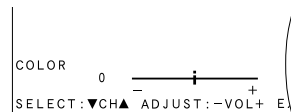





6 Press the **VOL (+)/(-)** to make adjustment.

7 Press the **MENU** to return to the main screen.



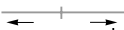

ADJUSTMENT (Continued)

Adjusting the VIDEO ADJUST Settings (Continued)

TV mode

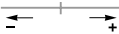
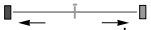
Selected item	Press the VOL (-) .	Press the VOL (+) .
PICTURE	Decrease contrast 	Increase contrast
TINT	Toward purple 	Toward green
COLOR	Lower color intensity 	Higher color intensity
BLACK LEVEL	Less bright 	More bright
SHARPNESS	Soft picture 	Sharp picture
COLOR SYSTEM	 → N358 ↔ PAL-M ↔ PAL-N ←	

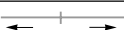
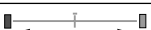
AV mode

Selected item	Press the VOL (-) .	Press the VOL (+) .
PICTURE	Decrease contrast 	Increase contrast
TINT/WHITE BALANCE	Toward purple 	Toward green
COLOR	Lower color intensity 	Higher color intensity
BLACK LEVEL	Less bright 	More bright
SHARPNESS	Soft picture 	Hard picture
RED-BLUE	More red level 	More blue level
GREEN	Less green level 	More green level
COLOR SYSTEM	Press the VOL (+)/(-) to select COLOR SYSTEM.  → AUTO ↔ N358 ↔ N443 ↔ PAL ↔ PAL-M ↔ PAL-N ↔ SECAM ↔ PAL60 ←	

Note:

- TINT is displayed only when N358 or N443 is selected.
- COLOR SYSTEM is displayed only when in the AV mode.
- In BLUE BACK, PICTURE setting displayed in purple cannot be selected.
- Selecting RESET will return all settings to the factory settings.
- TV mode
 - This product is factory set to comply with the color system (NTSC-N358) in the United States. For Brazil (PAL-M), Argentina (PAL-N) and Uruguay (PAL-N), set the color system before using this product.
- COLOR SYSTEM
 - Set the system to AUTO for normal reception. The AUTO mode automatically detects the receiving signal system and changes the reception system of the set.
 - When the picture or sound is not stable, switching to an appropriate system may improve the picture or sound quality.

ADJUSTMENT (Continued)

Adjusting the PRESET Settings

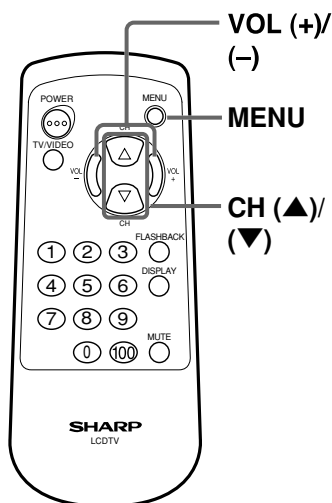

■ The PRESET items can be set by the user.

- 1 Press the **MENU** to display the MENU screen.
- 2 Press the **CH (▲)/(▼)** to move the cursor to PRESET.
- 3 Press the **VOL (+)/(-)** to display PRESET screen.
- 4 Check the factory setting of each item on the PRESET screen. The user can change the settings by using **CH (▲)/(▼)** and **VOL (+)/(-)**.
- 5 Press the **MENU** to return to the main screen.

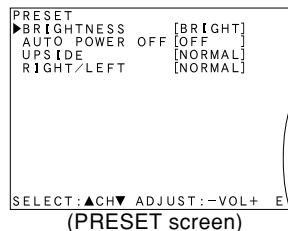
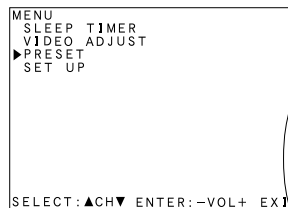
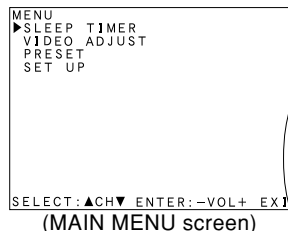

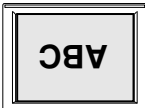
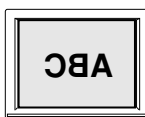
Selected item	Factory setting	Setting change
Brightness	[BRIGHT] Maximum brightness	[NORMAL] Brightness 60% → Suitable for viewing in well-lit areas. Saves energy. [DARK] Brightness 20% → Sufficiently bright when viewing in dim areas.
Auto Power Off (only TV mode)	[OFF]	[ON] The power of the LCD TV set is turned off when there is no signal for 5 minutes. [OFF] This feature is inactivated.
UPSIDE	[NORMAL] Normal vertical image orientation	[DOWN] Inverted image → To display images upside down for special uses. 
RIGHT/LEFT	[NORMAL] Normal horizontal image orientation	[MIRROR] Mirror image → To display mirror images for special uses. 

* Brightness can be adjusted by using the BRIGHT button on the top control panel of the main unit.

ADJUSTMENT (Continued)

SETUP

■ EZ SETUP

By operating the channel presetting functions, you can preset your LCD TV to the desired channels for viewing.

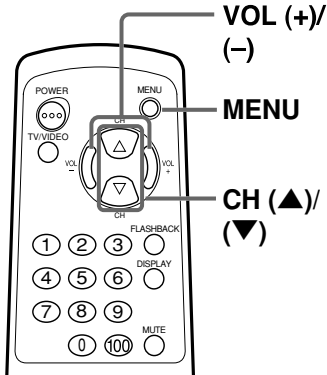

- 1 Press **MENU** to display the MENU screen.
- 2 Press **CH (▲)/(▼)** to move the “▶” mark to “SETUP”.
- 3 Press **VOL (+)/(-)** to display SETUP mode, then press **CH (▲)/(▼)** to move the “▶” mark to “CH SETTING”.

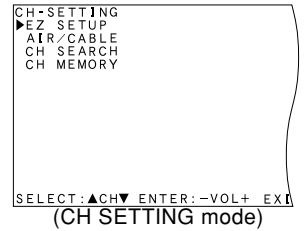
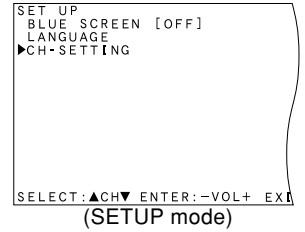
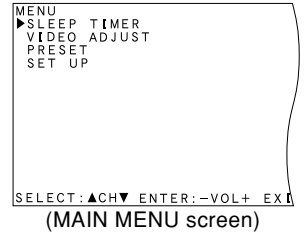

- 4 Press **VOL (+)/(-)** to display CH SETTING mode.
- 5 Press **VOL (+)/(-)** to display EZ SETUP mode.

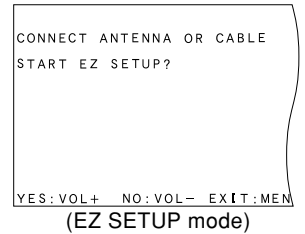

- 6 Press **VOL (+)**.
The tuner will automatically search for the broadcasting and cable TV channels. (The CH No. will automatically increase when it appears.)

If you want to stop the EZ SETUP process once it has started, press **VOL (-)**. Search will be canceled.

Press **VOL (-)** to cancel EZ SETUP.

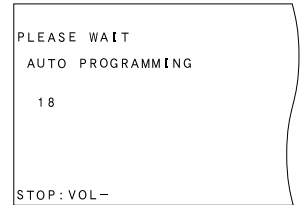

- 7 Once EZ SETUP is completed, the smallest channel number memorized will be displayed.



ADJUSTMENT (Continued)

SETUP (Continued)

■ CHANNEL SETTING

If EZ SETUP does not memorize all the channels in your region, follow the instructions below to manually memorize the channel.

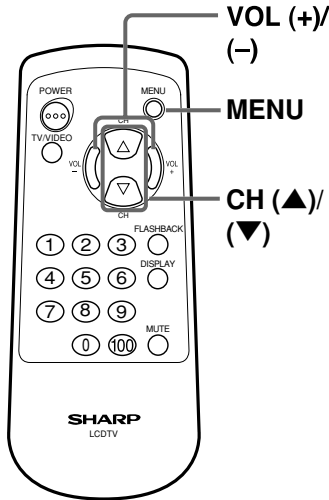

- 1** Press **MENU** to display the MENU screen.
- 2** Press **CH (▲)/(▼)** to move the "▶" mark to "SETUP".
- 3** Press **VOL (+)/(-)** to display SETUP mode.
- 4** Press **CH (▲)/(▼)** to move the "▶" mark to "CH SETTING".
- 5** Press **VOL (+)/(-)** to display CH SETTING mode.
- 6** Press **CH (▲)/(▼)** to move the "▶" mark to "AIR/CABLE", then press **VOL (+)/(-)** to display AIR/CABLE mode.
- 7** Press **CH (▲)/(▼)** to move the "▶" mark to the desired mode.
- 8** Press **MENU** to exit.

```

MENU
▶ SLEEP TIMER
VIDEO ADJUST
PRESET
SET UP

SELECT:▲CH▼ ENTER:-VOL+ EX]
(MAIN MENU screen)
    
```

```

SET UP
BLUE SCREEN [ON]
▶ EZ SETUP
CH-SETTING

SELECT:▲CH▼ ENTER:-VOL+ EX]
(SETUP mode)
    
```

```

CH-SETTING
▶ EZ SETUP
AIR/CABLE
CH SEARCH
CH MEMORY

SELECT:▲CH▼ ENTER:-VOL+ EX]
(CH SETTING mode)
    
```

```

CH-SETTING
EZ SETUP
▶ AIR/CABLE
CH SEARCH
CH MEMORY

SELECT:▲CH▼ ENTER:-VOL+ EX]
    
```

```

AIR/CABLE
AIR
CABLE STD
▶ CABLE HRC
CABLE IRC

SELECT:▲CH▼ ENTER:-VOL+ EX]
(AIR/CABLE mode)
    
```

Note:

- Receivable channels of your TV set are:
 - AIR channels:
 - VHF: 2 through 13.
 - UHF: 14 through 69.

- CABLE channels:
 - 1 (HRC and IRC mode only)
 - 2 through 125 (STD, HRC and IRC)

ADJUSTMENT (Continued)

SETUP (Continued)

■ Saving broadcast TV channels into memory.

- 1.1 Press **MENU** to display the MENU screen, then press **CH (▲)/(▼)** to move the "▶" mark to CH SETTING.
- 1.2 Press **VOL (+)/(-)** to display SETUP mode, then press **CH (▲)/(▼)** to move the "▶" mark to "CH SETTING".
- 1.3 Press **VOL (+)/(-)** to display CH SETTING screen.
- 1.4 Press **CH (▲)/(▼)** to move the "▶" mark to "CH SEARCH", then press **VOL (+)/(-)** to display CH SEARCH screen.

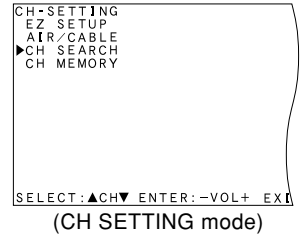

START

- 2.1 Press **VOL (+)**. The tuner will search through all available channels in your area and add them into the TV's memory.

STOP

- 2.2 Press **VOL (-)**. CH SEARCH will stop at the current channel and will not add any higher channels.
- 2.3 Press **MENU** to exit.

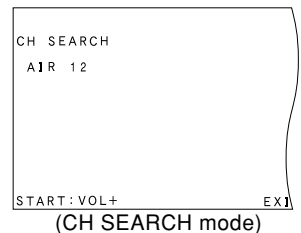

■ Adding weak or additional channels or erasing unwanted channels from TV memory.

- 1.1 Press **MENU** to display the MENU screen, then press **CH (▲)/(▼)** to move the "▶" mark to "SETUP".
- 1.2 Press **VOL (+)/(-)** to display SETUP mode, then press **CH (▲)/(▼)** to move the "▶" mark to "CH SETTING".
- 1.3 Press **VOL (+)/(-)** to display CH SETTING mode, then press **CH (▲)/(▼)** to move the "▶" mark to "CH MEMORY".

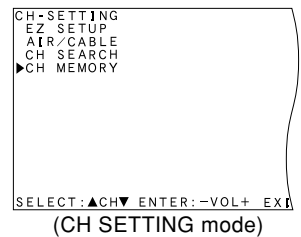

- 2.1 Press **VOL (+)/(-)** to display CH MEMORY.
- 2.2 Use **CH (▲)/(▼)** or **CHANNEL SELECT** to select each desired channel to add or erase.
- 2.3 Press **VOL (+)** to add a channel to the TV's memory or press **VOL (-)** to erase a channel from the TV's memory.
- 2.4 Press **MENU** to exit.

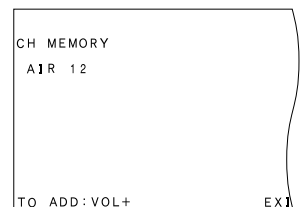

VOL (+) to add channel 12 to the TV memory
VOL (-) to erase channel 12 to the TV memory

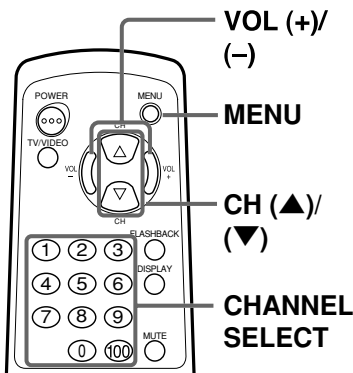
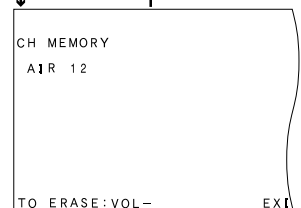

Note:

- If you press **VOL (+)** again while in the CH SEARCH mode, auto-program will start again, and the previously memorized channels will be lost.

ADJUSTMENT (Continued)

Adjusting the BLUE SCREEN Settings

■ BLUE SCREEN

Automatically turns the screen blue if a broadcast signal is not received.

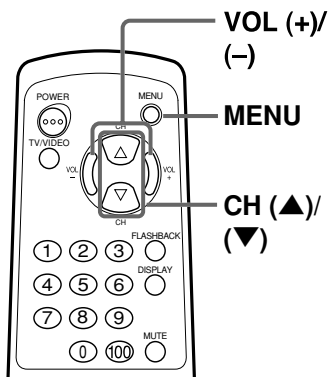

- 1 Press the **MENU** to display the MENU screen.
- 2 Press **CH (▲)/(▼)** to move the **▶** mark to "SET UP".
- 3 Press **VOL (+)/(-)** to display SETUP mode.

```
MENU
▶ SLEEP TIMER
VIDEO ADJUST
PRESET
SET UP

SELECT:▲CH▼ ENTER:-VOL+ EX]
```

(MAIN MENU screen)

```
SET UP
▶ BLUE SCREEN [OFF]
LANGUAGE
CH-SETTING

SELECT:▲CH▼ ENTER:-VOL+ EX]
```

(SETUP mode)

- 4 Press the **VOL (+)/(-)** to display BLUE SCREEN select mode.

```
SET UP
▶ BLUE SCREEN [ON ]
LANGUAGE
CH-SETTING

SELECT:▲CH▼ ENTER:-VOL+ EX]
```

(SETUP mode)

- 5 Press the **VOL (+)/(-)** to select "ON".
- 6 Press the **MENU** to exit.

Notes:

- Poor reception due to weak signals, or too much noise might activate the BLUE SCREEN function despite the presence of a broadcast signal. To continue watching TV under these conditions, switch the BLUE SCREEN "OFF".
- While AV input mode is selected, the BLUE SCREEN will not be shown on your TV even if the BLUE SCREEN is turned on.

LISTENING WITH A HEADPHONE

- Plug the headphone mini-plug into the headphone jack located on the rear side of the set.

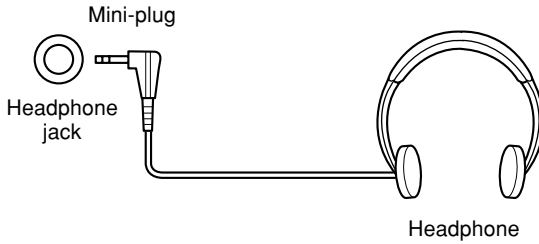

▼ Screen display

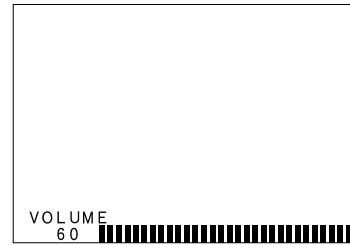

Notes:

- The headphone is not included in the supplied accessories.
- No sound will be heard from the main unit speakers when connecting the headphone set.

EXAMPLE OF APPLICATION

View by mounting the set to the wall using mounting bracket.

- When using the unit on the wall, etc. (Installation example)

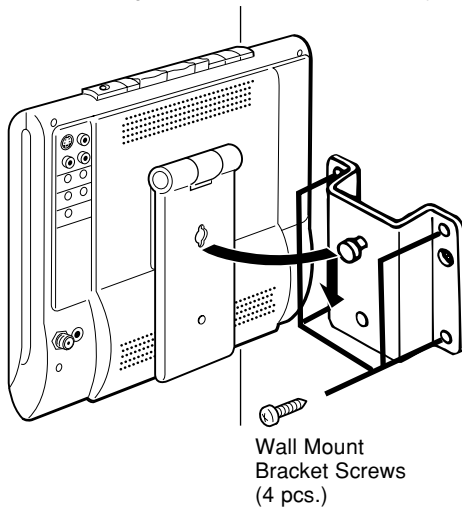

CAUTION:

The thickness and the material of the wall must use plywood or solid wood of 0.5 in. (12 mm) or more in thickness.

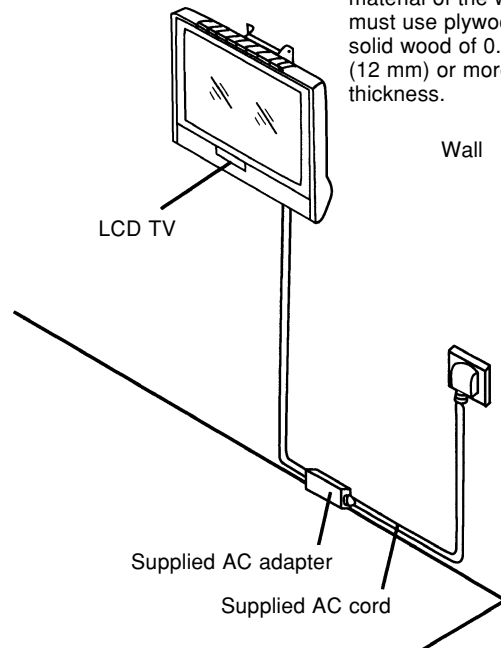

Notes: Location of installation

- Do not install the unit in a place exposed to vapor.
- Do not install the unit in a place exposed to oily soot.
- Install the unit in locations having room temperatures within 0°C to 40°C.
- This product is not designed to resist water. Make sure to install the unit in a place not exposed to water or oily soot.

CONNECTING WITH EXTERNAL DEVICES

It is possible to enjoy video and sound by connecting VCR's and home video game systems to the terminals located on the rear of the main unit.

When connecting an external device, turn off the power of the main unit and connecting device to prevent any possible damage.

Example of external devices that can be connected.

- Video camera
- Home video game system
- VCR
- Laser disc player

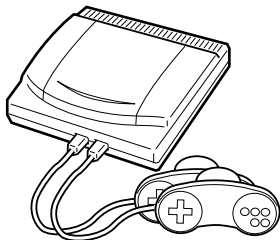
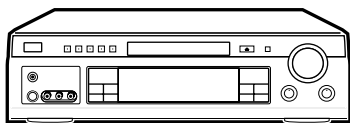
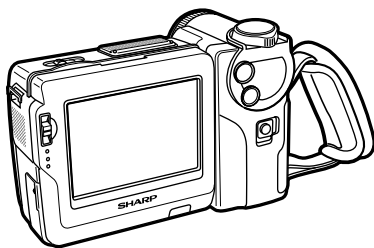

To AV-IN 1 or 2 terminal

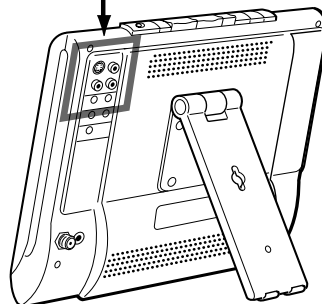

* PC connection not available.

Notes:

- For the cable, use a commercially available video/audio cord.
- Only connect video/audio signals to AV-IN 1 and 2 terminals. Connecting other signals may result in malfunction.
- The video input terminal and the S-Video input terminal on the AV-IN side are shared connections with priority given to the S-Video terminal. When making connections to both terminals, the screen when selecting AV-IN 1 will be that from the S-Video input terminal.
When viewing video from the video input terminal, do not make any connection to the S-Video input terminal.
- For details concerning the usage and connection of the connecting devices, see the respective instruction manuals.

CONNECTING WITH EXTERNAL DEVICES (Continued)

Connecting a VCR or home video game system (AV-IN 1/2)

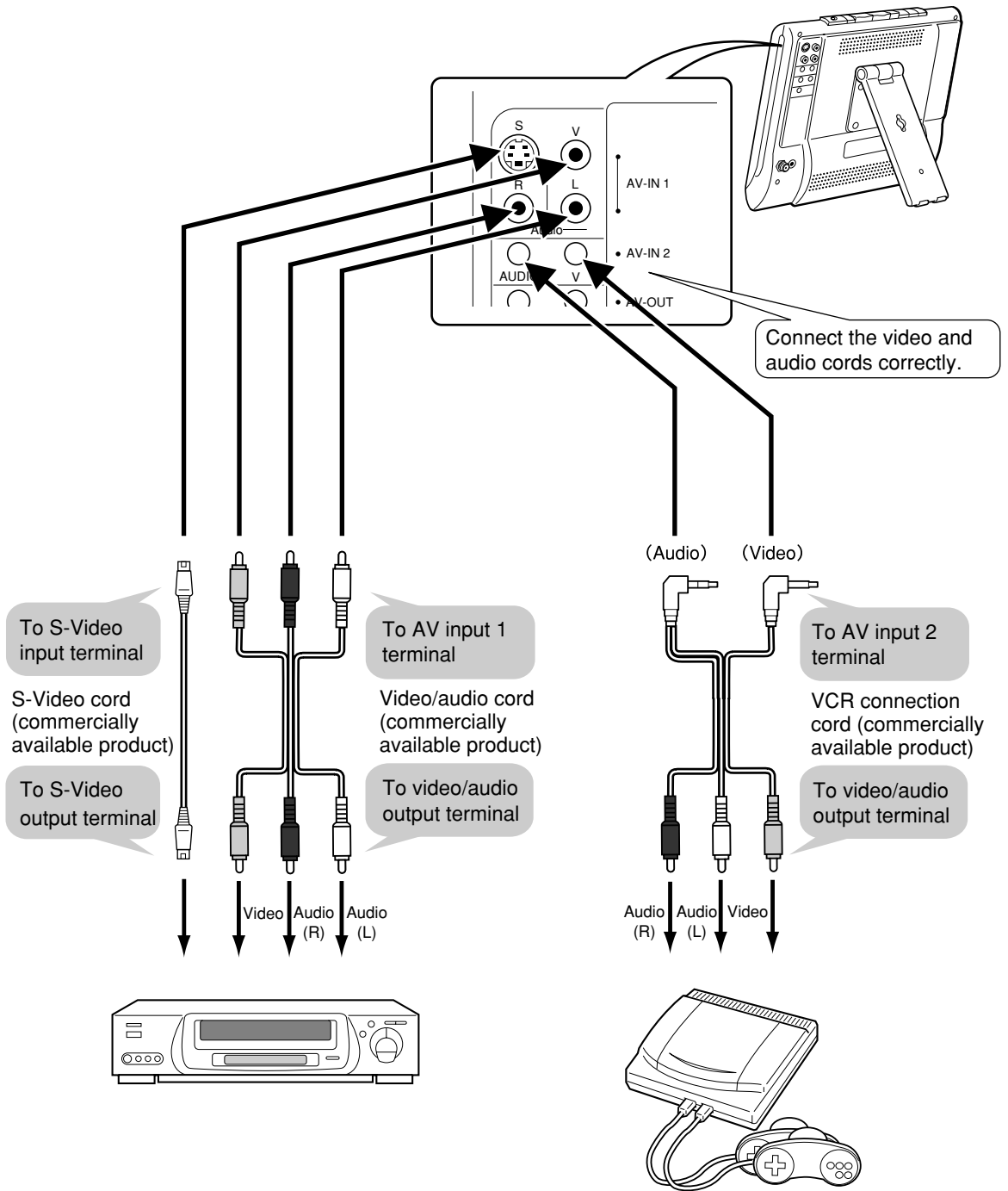

Notes:

- When connecting both Video input and S-Video terminals for AV-IN 1, priority is given to the S-Video input.
- Do not connect antennas or headphones to AV-IN 2.

CONNECTING WITH EXTERNAL DEVICES (Continued)

Outputting video and audio (video output)

It is possible to output video and audio from the set through the AV output terminal (AV-OUT).

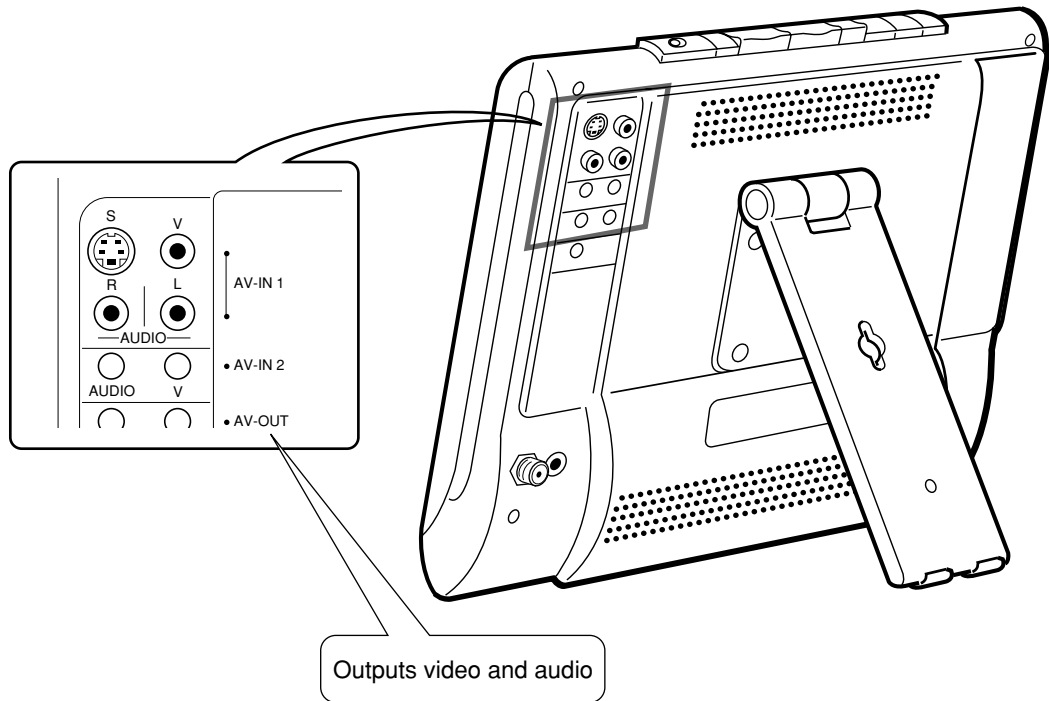





Note:

- When using S-Video input for AV-IN 1, no video output will be made to the AV output terminal, but audio output will be made for connection to external audio systems.

TROUBLESHOOTING

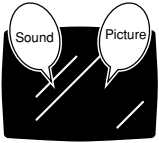
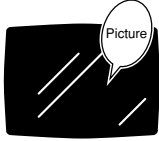

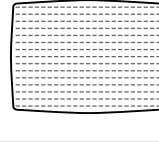

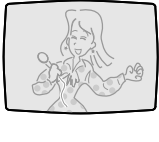
■ Before calling for repair service, check the following items for possible remedies to the encountered symptoms.

TV set

Problem	Check item	Reference Pages
 <p>There is no picture or sound.</p>	<ul style="list-style-type: none"> • Make sure the AC adapter is properly inserted in the power outlet. • Reception other than those of broadcasting stations can be considered. • Make sure the input mode is set to TV. • Make sure the main power switch of the main unit is on. 	<p>18</p> <p>14</p> <p>14</p>
 <p>There is no picture. There is no picture from AV-IN 1.</p>	<ul style="list-style-type: none"> • Make sure the BLACK LEVEL is properly adjusted. • Fluorescent lamp may have reached the end of service life. • Make sure the S-Video terminal is free of connections. 	<p>20, 21</p> <p>–</p> <p>29</p>
 <p>There is no sound.</p>	<ul style="list-style-type: none"> • Make sure the volume is not set to minimum. • Make sure the sound is not set to mute. • Make sure the headphone is not connected. 	<p>15</p> <p>15</p> <p>27</p>
 <p>There is no picture or sound, just noise.</p>	<ul style="list-style-type: none"> • Make sure the antenna cable is properly connected. • Bad reception can be considered. 	<p>9</p> <p>–</p>
 <p>Picture is not clear.</p>	<ul style="list-style-type: none"> • Make sure the antenna cable is properly connected. • Bad reception can be considered. 	<p>9</p> <p>–</p>
 <p>Picture is light or improperly tinted.</p>	<ul style="list-style-type: none"> • Check color adjustment. • Check color system setting. 	<p>20, 21</p>
 <p>The picture is too dark.</p>	<ul style="list-style-type: none"> • Press the Brightness button. • Check PICTURE and BLACK LEVEL adjustment. • Fluorescent lamp may have reached the end of service life. 	<p>20, 21</p> <p>33</p>
<p>Remote control does not work.</p>	<ul style="list-style-type: none"> • Check to see if batteries in the remote control have sufficient power. • Make sure the remote sensor window is not under strong fluorescent lighting. 	<p>8</p> <p>8</p>

TROUBLESHOOTING (Continued)

Antenna

Problem	Check item
 <p>The picture is not sharp.</p>  <p>The picture moves.</p>	<ul style="list-style-type: none"> • The reception may be weak. • The state of the broadcast may also be bad. • Make sure the antenna is facing the right direction. • Make sure the outside antenna is not disconnected.
 <p>The picture is doubled or tripled.</p>	<ul style="list-style-type: none"> • Make sure the antenna is facing the right direction. • There may be reflected electric waves from mountains or buildings.
 <p>The picture is spotted.</p>	<ul style="list-style-type: none"> • There may be interference from automobiles, trains, high voltage lines, neon lights, etc. • There may be interference between the antenna cable and power cable. Try positioning them further apart.
 <p>There are stripes on the screen or colors fade.</p>	<ul style="list-style-type: none"> • Is the unit receiving interference from other devices? Transmission antennas of radio broadcasting stations and transmission antennas of amateur radios and cellular phones may also cause interference. • Use the unit as far apart as possible from devices that may cause possible interference.

SPECIFICATIONS

ITEMS		MODEL	LC-10A2U
LCD panel			10.4" TFT LCD
Number of pixels			921,600 pixels VGA
Video color systems			N358, N443, PAL, PAL-M, PAL-N, SECAM, PAL-60
TV FUNCTION	Destination		USA/Latin A/Twn
	TV Standard (CCIR)		NTSC/PAL-M/PAL-N
	TV Turning System		PLL 181 ch.
	STEREO		AV STEREO
	EZ SETUP		Yes
	CATV		125 ch.
4-LINE COMB FILTER			Yes
Brightness			400 cd/m ²
Lamp life			25,000 Hours
Viewing angles			H: 120° V: 100°
Audio amplifier			1.0 W × 2
Speakers			1-3/16 × 1-37/64 in. (3 × 4 cm), 2 pcs
Terminals	AV1		AV-IN 1, S-IN
	AV2		AV-IN 2
	AV OUT		AV-OUT
	ANT		F-Type
	H/P		Mini-jack for stereo (3.5 ø) (Rear)
OSD LANGUAGE			English/French/Spanish
Power supply			DC 12 V, AC110-240 V
Weight			3.97 lbs (1.8 kg) w/o accessories
Accessories			R/C, Batteries, Wall mount parts, Antenna cable, AC adapter, AC cord

■ Design and specifications are subject to change without notice.

DIMENSIONAL DRAWINGS

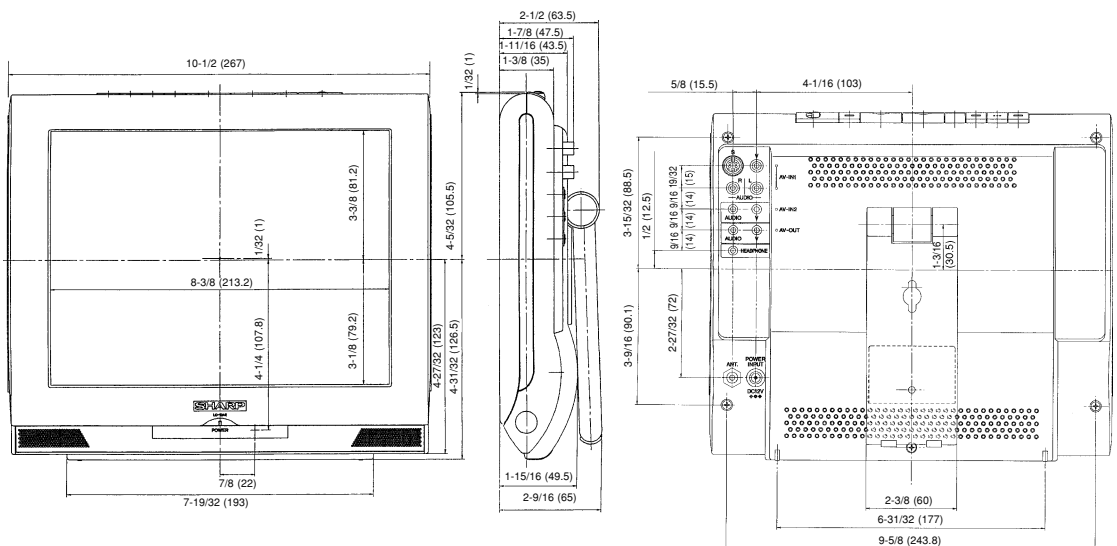

Calling for Service

For location of the nearest Sharp Authorized Service, or to obtain product literature, accessories, supplies, or customer assistance, please call 1-800-BE-SHARP.

LIMITED WARRANTY

END-USER LIMITED WARRANTY

SHARP ELECTRONICS CORPORATION warrants to the first end user purchaser that this Sharp brand product (the "Product"), when shipped in its original container, will be free from defective workmanship and materials, and agrees that it will, at its option, either repair the defect or replace the defective Product or part thereof with a new or remanufactured equivalent at no charge to the purchaser for parts or labor for the period(s) set forth below.

This warranty does not apply to any appearance items of the Product nor to the additional excluded item(s) set forth below nor to any Product the exterior of which has been damaged or defaced, which has been subjected to improper voltage or other misuse, abnormal service or handling, or which has been altered or modified in design or construction.

In order to enforce the rights under this limited warranty, the purchaser should follow the steps set forth below and provide proof of purchase to the servicer.

To the extent permitted by applicable state law, the warranties set forth herein are in lieu of, and exclusive of, all other warranties, express or implied. Specifically, ALL OTHER WARRANTIES OTHER THAN THOSE SET FORTH ABOVE ARE EXCLUDED. ALL EXPRESS AND IMPLIED WARRANTIES INCLUDING THE WARRANTIES OF MERCHANTABILITY, FITNESS FOR USE, AND FITNESS FOR A PARTICULAR PURPOSE ARE SPECIFICALLY EXCLUDED. If, under applicable state law, implied warranties may not validly be disclaimed or excluded, the duration of such implied warranties is limited to the period(s) from the date of purchase set forth below.

Neither the sales personnel of the seller nor any other person is authorized to make any warranties other than those described herein, or to extend the duration of any warranties beyond the time period described herein on behalf of Sharp.

The warranties described herein shall be the sole and exclusive warranties granted by Sharp and shall be the sole and exclusive remedy available to the purchaser. Correction of defects, in the manner and for the period of time described herein, shall constitute complete fulfillment of all liabilities and responsibilities of Sharp to the purchaser with respect to the Product, and shall constitute full satisfaction of all claims, whether based on contract, negligence, strict liability or otherwise. In no event shall Sharp be liable, or in any way responsible, for any damages or defects in the Product which were caused by repairs or attempted repairs performed by anyone other than an authorized servicer. Nor shall Sharp be liable or in any way responsible for any incidental or consequential economic or property damage. Some states do not allow limits on warranties or on remedies for breach in certain transactions; in such states, the limits herein may not apply.

Model Specific Section

Your Product Model Number & Description: LC-10A2U-B/LC-10A2U-W LCD Color Television
(Be sure to have this information available when you need service for your Product.)

Warranty Period for this Product: One (1) year parts and labor from the date of purchase.

Additional Item(s) Excluded from Warranty Coverage (if any): None

Where to Obtain Service: From a Sharp Authorized Servicer located in the United States.
To find the location of the nearest Sharp Authorized Servicer, call Sharp toll free at 1-800-BE-SHARP.

What to do to Obtain Service: Ship prepaid or carry in your Product to a Sharp Authorized Servicer. Be sure to have **Proof of Purchase** available. If you ship the Product, be sure it is insured and packaged securely.

TO OBTAIN PRODUCT INFORMATION, CALL 1-888-LCD-SHARP.

SHARP®

SHARP ELECTRONICS CORPORATION

Sharp Plaza, Mahwah, New Jersey 07430-2135

ENGLISH

FRANÇAIS

SHARP®

LC-10A2U

NOM 1245  NYCE

Impreso en papel reciclado.
Impresso em papel reciclado pós utilização.

IMPRESO EN JAPÓN
IMPRESO NO JAPÃO
TINS-7236CEZZ
OC. T2444-A



LCD COLOR TELEVISION
TÉLÉVISION COULEUR À
ÉCRAN À CRISTAUX
LIQUIDES (LCD)

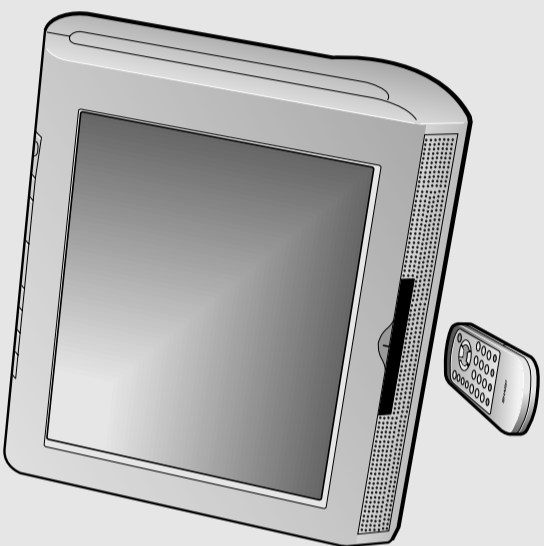

MANUAL DE MANEJO
MANUAL DE OPERAÇÃO

LCD TELEVISION EN COLOR
TELEVISOR COLORIDO LCD

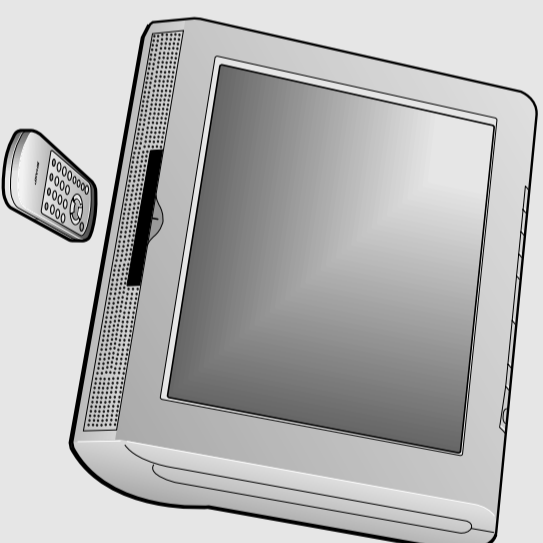

OPERATION MANUAL
MODE D'EMPLOI



SHARP®

SHARP®

Printed on post-consumer recycled paper.
Imprimé sur du papier recyclé.

PRINTED IN JAPAN
IMPRIMÉ AU JAPON
TINS-7236CEZZ
OC. T2444-A

PORTUGUÊS

ESPAÑOL