

SHARP®

COLOR TELEVISION

MODEL
27F540
32F540

OPERATION MANUAL

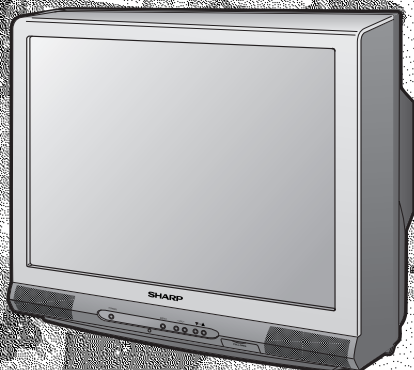

Products that have earned the ENERGY STAR® are designed to protect the environment through superior energy efficiency.

CONTENTS

	PAGE	PAGE	
• IMPORTANT INFORMATION/IMPORTANT SAFEGUARDS	2-4	• Closed Caption	14
• Supplied Accessories	5	• Parent Control	15-25
• Before Operating Your Television	5	V-CHIP Operation	15-22
• Antenna Connections	5, 6	VIEW TIMER	23-25
• Quick Reference Control Operation	7	• Energy Save	26
• EZ SETUP during First Use	8	• Set Up	27-33
• Demo Mode	9	EZ Setup	27
• Accessing the MAIN MENU screen without Remote Control	9	Channel Setting	28-30
• Language	10	Blue Screen	30, 31
• Sleep Timer	10	Personal Preference	32
• Video Adjust	11	Universal Plus Function	33
• Audio Select	12, 13	• Auto Input	34
MTS (Multichannel TV Sound)	12	Channel ID	35, 36
SPEAKER (Internal Speaker Switch)	12	• Screen Format	37
FAO (Fixed Audio Output)	12	• Using the Video and Audio Input Terminals	38, 39
AUDIO ADJUST	13	• Using the Audio Output Terminals	40
		• Operation of Universal Remote Control	41-44
		• Before Calling for Service	45
		• Calling for Service	45
		• Specifications	46
		• Limited Warranty	57

This operation manual includes basic operating instructions in Spanish and French.
SPANISH is on page 47-51.
FRENCH is on page 52-56.

B092 WJ

Welcome to the SHARP Family. We are pleased that you are now the owner of a SHARP Color Television – built for outstanding quality, reliability and performance.

Every SHARP Color Television set is tuned and adjusted for proper color and sound, and has passed through the most stringent quality control tests at the factory. We have prepared this OPERATION MANUAL so that you may adjust the picture and color to your personal viewing preference.

We sincerely hope that you receive the greatest satisfaction and enjoyment from your new SHARP Color Television set for years to come.

Please read these instructions carefully, and keep them handy for your future reference.

IMPORTANT

To aid reporting in case of loss or theft, please record the TV's model and serial numbers in the space provided. The numbers are located at the rear of the TV.

Model No.:

Serial No.:

IMPORTANT INFORMATION

There are two important reasons for prompt warranty registration of your new SHARP television set. Use the REGISTRATION CARD packed in with the set.

FIRST – WARRANTY

This is to assure that you will immediately receive the full consumer benefit of the parts, service and labor warranty applicable to your purchase.

SECOND – CONSUMER PRODUCT SAFETY ACT

To assure that you will promptly receive any safety notification on inspection, modification or recall that SHARP may be required to give under the 1972 Consumer Product Safety Act. PLEASE READ CAREFULLY THE IMPORTANT "LIMITED WARRANTY" CLAUSE ON THE LAST PAGE.

WARNING: TO REDUCE THE RISK OF FIRE OR ELECTRIC SHOCK, DO NOT EXPOSE THIS APPLIANCE TO WET LOCATIONS.



CAUTION

**RISK OF ELECTRIC SHOCK
DO NOT OPEN**



The lightning flash with arrowhead within a triangle is intended to tell the user that parts inside the product are a risk of electric shock to persons.

CAUTION: TO REDUCE THE RISK OF ELECTRIC SHOCK,
DO NOT REMOVE COVER (OR BACK).
NO USER-SERVICEABLE PARTS INSIDE.
REFER SERVICING TO QUALIFIED SERVICE PERSONNEL.



The exclamation point within a triangle is intended to tell the user that important operating and servicing instructions are in the papers with the appliance.

"Note to CATV system installer: This reminder is provided to call the CATV system installer's attention to Article 820-40 of the National Electrical Code that provides guidelines for proper grounding and, in particular, specifies that the cable ground shall be connected to the grounding system of the building, as close to the point of cable entry as practical."

WARNING – FCC Regulations state that any unauthorized changes or modifications to this equipment not expressly approved by the manufacturer could void the user's authority to operate this equipment.

PRODUCT DISPOSAL

This product utilizes a Cathode Ray Tube (CRT) containing lead and tin-lead solder. Disposal of these materials may be regulated due to environment considerations. For disposal or recycling information, please contact your local authorities or the Electronics Industries Alliance: www.eiae.org

IMPORTANT INFORMATION (Continued)

CAUTION:

- Do not place the AC power cord under the TV set or other heavy items.
- To prevent fire, never place any type of candle or naked flames on the top or near the TV set.
- To prevent fire or shock hazard, do not expose this products to dripping or splashing. No objects filled with liquids, such as vases, should be placed on the product.

IMPORTANT SAFEGUARDS

CAUTION: Please read all of these instructions before you operate your television and save these instructions for later use.

Electrical energy can perform many useful functions. This unit has been engineered and manufactured to assure your personal safety. BUT IMPROPER USE CAN RESULT IN POTENTIAL ELECTRICAL SHOCK OR FIRE HAZARDS. In order not to defeat the safeguards incorporated in this equipment, observe the following basic rules for its installation, use and servicing.

1. Unplug this television equipment from the wall outlet before cleaning.
2. Do not use liquid cleaners or aerosol cleaners. Use a damp cloth for cleaning.
3. Do not use attachments not recommended by the television equipment manufacturer as they may cause hazards.
4. Do not use this television equipment near water — for example, near a bath tub, washbowl, kitchen sink or laundry tub, in a wet basement, or near a swimming pool, etc.
5. Do not place this equipment on an unstable cart, stand, or table. The television equipment may fall, causing serious injury to a child or an adult, and serious damage to the equipment. Use only with a cart or stand recommended by the manufacturer or sold with the television equipment.
6. Television equipment and cart combination should be moved with care. Quick stops, excessive force, and uneven surfaces may cause the equipment and cart combination to overturn.
7. Wall or shelf mounting should follow the manufacturer's instructions, and should use a mounting kit approved by the manufacturer.
8. Slots and openings in the cabinet and the back or bottom are provided for ventilation. To insure reliable operation of the television equipment and to protect it from overheating, these openings must not be blocked or covered. This television equipment should not be placed in a built-in insulation such as a bookcase unless proper ventilation is provided.
9. The openings should never be covered with a cloth or other material, and the bottom openings should not be blocked by placing the television equipment on a bed, sofa, rug, or other similar surface. This television equipment should never be placed near or over a radiator or heat register.
10. This television equipment should be operated only from the type of power source indicated on the marking label. If you are not sure of the type of power supplied to your home, consult your television dealer or local power company.



For television equipment designed to operate from battery power, refer to the operating instructions.

11. As a safety feature, television equipment is equipped with a 2-wire polarized plug (one plug blade bigger than the other). The 2-wire polarized plug will fit only one way into the power outlet.
If the plug does not fit, ask your electrician to replace your obsolete outlet. Do not modify the plug and defeat this safety feature.
12. Do not allow anything to rest on the power cord. Do not locate this television equipment where the cord will be abused by persons walking on it.

IMPORTANT SAFEGUARDS (Continued)

13. Follow all warnings and instructions marked on the television equipment.
14. If an outside antenna is connected to the television equipment, be sure the antenna system is grounded so as to provide some protection against voltage surges and built-up static charges. Section 810 of the National Electrical Code provides information with respect to proper grounding of the mast and supporting structure, grounding of the lead-in wire to an antenna discharge unit, size of grounding conductors, location of antenna-discharge unit, connection to grounding electrodes, and requirements for the grounding electrode.

EXAMPLE OF ANTENNA GROUNDING AS PER
NATIONAL ELECTRICAL CODE

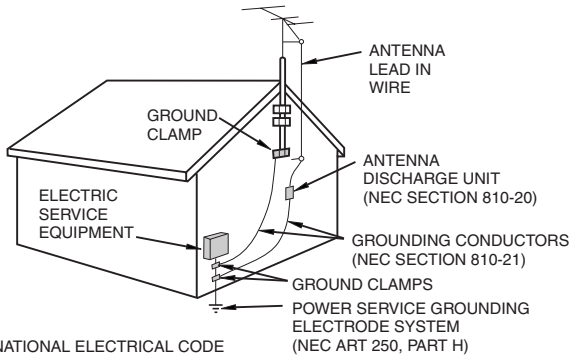

15. For added protection for this television equipment during a lightning storm, or when it is left unattended and unused for long periods of time, unplug it from the wall outlet and disconnect the antenna. This will prevent damage to the equipment due to lightning and power-line surges.
16. An outside antenna system should not be located in the vicinity of overhead power lines or other electric light or power circuits, or where it can fall into such power lines or circuits. When installing an outside antenna system, extreme care should be taken to keep from touching such power lines or circuits as contact with them might be fatal.
17. Do not overload wall outlets and extension cords as this can result in fire or electric shock.
18. Never push objects of any kind into this television equipment through cabinet slots as they may touch dangerous voltage points or short out parts that could result in a fire or electric shock. Never spill liquid of any kind on the television equipment.
19. Do not attempt to service this television equipment yourself as opening or removing covers may expose you to dangerous voltage or other hazards. Refer all servicing to qualified service personnel.
20. Unplug this television equipment from the wall outlet and refer servicing to qualified service personnel under the following conditions:
 - A. When the power cord or plug is damaged or frayed.
 - B. If liquid has been spilled into the television equipment.
 - C. If the television equipment has been exposed to rain or water.
 - D. If the television equipment does not operate normally by following the operating instructions. Adjust only those controls that are covered by the operating instructions as improper adjustment of other controls may result in damage and will often require extensive work by a qualified technician to restore the television equipment to normal operation.
 - E. If the television equipment has been dropped or the cabinet has been damaged.
 - F. When the television equipment exhibits a distinct change in performance — this indicates a need for service.
21. Upon completion of any service or repairs to this television equipment, ask the service technician to perform routine safety checks to determine that the television is in safe operating condition.
22. When replacement parts are required, be sure the service technician has used replacement parts specified by the manufacturer that have the same characteristics as the original part. Unauthorized substitutions may result in fire, electric shock, or other hazards.

Supplied Accessories

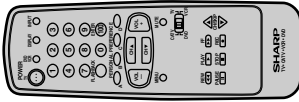

Infrared Remote Control
RRMCGA035WJSB

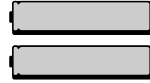

Size AA
Dry Batteries

Before Operating Your Television

Location

- For normal operation, your TV should be located in an area of the room where cool adequate ventilation is provided. Do not place the back of the television set in a place where free airflow will be restricted.
- Any magnetic force may disturb the color picture. Make sure that magnets, electric clocks, toys using magnets or any other magnetic substance, such as iron are kept well away from the TV set.

Power

Your TV operates on 120 Volts, 60 Hz (normal household current) and has a polarized plug. If you are unable to insert the plug fully into the outlet, try reversing the plug. Should it fail to fit, contact an electrician. Do not defeat the safety feature of the polarized plug.

Note:

- If the set is not going to be used for a long period, such as during a vacation, unplug the set from the wall outlet to economize power. (If the TV set is plugged in, a slight current still flows, even with the POWER BUTTON in the OFF position.)
- Lines and other noise may appear in TV broadcast images when an FM tuner or radio is located near the TV and both radio and TV broadcasts are being received. Should such noise appear, turn off the radio.
- If you are listening to an AM broadcast, turn the TV off. AM broadcast signals may not be received due to interference from the TV.
- **Before using the television, prepare the Remote Control**
To use the remote control, insert batteries first.

Inserting the batteries



- With your thumbnail, pull up the slit as indicated by the arrow to remove the battery cover. Insert two batteries (size "AA"). Be sure to match the battery \oplus/\ominus terminals with the \oplus/\ominus marks inside the compartment.

Antenna Connections

Antennas

- The antenna requirements for good color television reception are more important than those for black & white television reception. For this reason, a good quality outdoor antenna is strongly recommended. The following is a brief explanation of the type of connections that are provided with the various antenna systems:

1. A 75-ohm system is generally a round cable with F-type connector that can easily be attached to a terminal without tools (not supplied).
2. A 300-ohm system is a flat "twin-lead" cable that can be attached to a 75-ohm terminal through a 300/75-ohm ADAPTOR (not supplied).

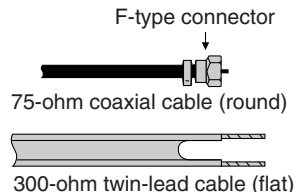

Antenna Connections (Continued)

OUTDOOR ANTENNA CONNECTION

- Refer to one of the following two diagrams when connecting to an outdoor antenna.
A: Using a VHF/UHF combination outdoor antenna.
B: Using separate VHF and/or UHF outdoor antenna.
- Connect an outdoor antenna cable lead-in to the ANT/CABLE terminal on the rear of the TV set.

A. Combination VHF/UHF Antennas

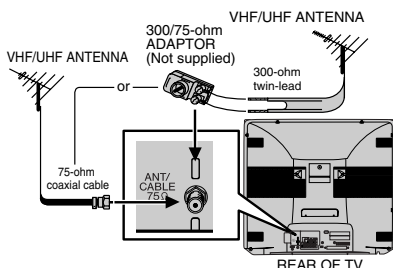

B. Separate VHF/UHF Antenna

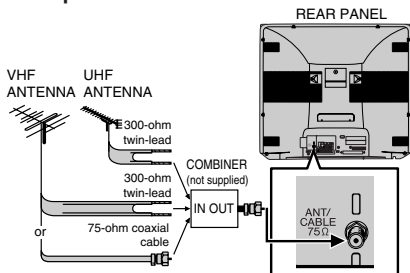

NOTICE

F-type connector should be finger-tightened only.

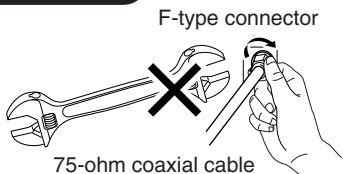

When connecting the RF cable to the TV set, do not tighten F-type connector with tools. If tools are used, it may cause damage to your TV set.
(The breaking of internal circuit, etc.)

CABLE TV (CATV) CONNECTION

- A 75 ohm coaxial cable connector is built into the set for easy hookup. When connecting the 75 ohm coaxial cable to the set, screw the 75 ohm cable to the COAXIAL CABLE CONNECTOR.
- Some cable TV companies offer "premium pay channels". Since the signals of these premium pay channels are scrambled, a cable TV converter/descrambler is generally provided to the subscriber by the cable TV company. This converter/descrambler is necessary for normal viewing of the scrambled channels. (Set your TV on channel 3 or 4. Typically one of these channels is used. If this is unknown, consult your cable TV company.) For more specific instructions on installing cable TV, consult your cable TV company. One possible method of utilizing the converter/descrambler provided by your cable TV company is explained below.
Please note: RF switch equipped with position A/B (not provided) is required.

"A" position on the RF switch (not supplied) : You can view all unscrambled channels using the TV's channel keys.

"B" position on the RF switch (not supplied) : You can view the scrambled channels via the converter/descrambler using the converter's channel keys.

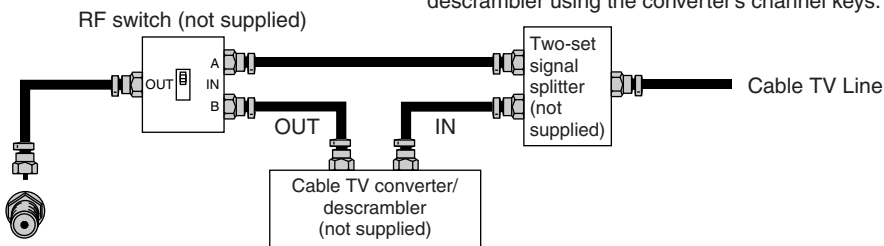

Note:

- Consult your SHARP Dealer or Service Center for the type of splitter, RF switch or combiner that might be required.

Quick Reference Control Operation

Part Names

Front Panel

POWER

Press → On.
Press again → Off.

REMOTE CONTROL SENSOR

MENU

Press → Accesses MAIN MENU.
Press again → Exits MAIN MENU.

VOLUME UP/DOWN

(+) Increases sound.
(-) Decreases sound.

VIDEO/AUDIO IN 2 TERMINALS (INSIDE DOOR)

CHANNEL UP/DOWN

(▲) Selects next higher channel.
(▼) Selects next lower channel.

Basic Remote Control Functions

POWER

Press → On.
Press again → Off.

REMOTE KEYPAD

Accesses any channel from keypad.

FLASHBACK

Returns to previous channel.

PERSONAL PREFERENCE

With the Personal Preference buttons, you can program your favorite programs by using the 4 categories A, B, C and D. The channels can be accessed quickly by using these buttons. (See page 32.)

VOLUME UP/DOWN

(+) Increases sound.
(-) Decreases sound.
• Changes or selects the TV adjustments on On-Screen Display.

MENU

Press → Accesses MAIN MENU.
Press again → Exits MAIN MENU.

CATV/DVD-TV/VCR MODE SELECT SWITCH

In TV/VCR position, signals sent will be for TV and VCR control.
In CATV/DVD position, signals sent will be for cable TV converter and DVD control.

DVD/VCR CONTROL

See page 41.

Infrared Transmitter Window

DISPLAY

Press → Displays receiving channel for 4 seconds.
Press again → Removes display.
• Temporarily displays receiving channel when in Closed Caption mode.

INPUT

Press → Switches to external video INPUT 1 mode.
Press twice → Switches to external video INPUT 2 mode.
Press 3 times → Switches to external video INPUT 3 mode or COMPONENT mode.
Press 4 times → Switches back to the original TV mode. See page 39.

ENTER

Used in some instances where a Cable Converter Box requires an "enter" command after selecting channels, when using the REMOTE KEYPAD button. See page 41.

CHANNEL UP/DOWN

(▲) Selects next higher channel.
(▼) Selects next lower channel.
• See pages 28-30 for Channel Setting.
• Moves the "●" mark on the MENU screens.

MUTE

Press → Mutes sound.
Press again → Restores sound.
• When sound is muted, CLOSED CAPTION appears if available.

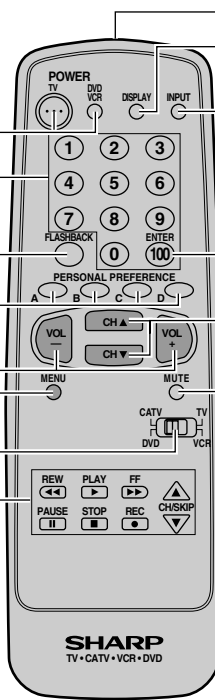

Note:

- The above shaded buttons on the Remote Control glow in the dark. To use the glow-in-the-dark display on the remote control, place it under a fluorescent light or other lighting.
- The phosphorescent material contains no radioactive or toxic material, so it is safe to use.
- The degree of illumination will vary depending on the strength of lighting used.
- The degree of illumination will decrease with time and depending on the temperature.
- The time needed to charge the phosphorescent display will vary depending on the surrounding lighting.
- Sunlight and fluorescent lighting are the most effective when charging the display.
- The TV set and remote control illustrations and the on-screen displays in this manual may differ from their actual appearance.
- The TV set illustrations on this page and after are those of 32F540.

EZ SETUP during First Use

- When you turn on the TV for the first time, it will automatically memorize the broadcasting channels.
Please perform the following instructions before pressing the **POWER** button.

- Insert the batteries into the remote control. (See page 5)
- Connect the antenna cable to the TV set. (See pages 5, 6)
- Plug in the AC POWER cord to the wall outlet.

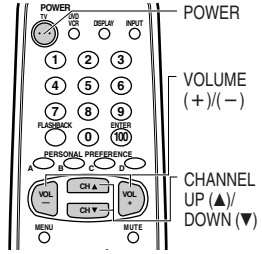

- Press the **POWER** button on the TV set or on the Remote Control to turn on the TV. The SELECT LANGUAGE screen will be displayed.

(On the Set) (On the Remote Control)

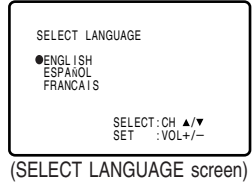

(SELECT LANGUAGE screen)

- Press **CH ▲/▼** to select “ENGLISH”, “ESPAÑOL (SPANISH)” or “FRANÇAIS (FRENCH)”.



- Press **VOL +/-** to access the EZ SETUP screen.

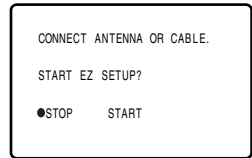
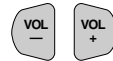

(EZ SETUP screen)

- Press **VOL +**.
The tuner will automatically search for the broadcasting and cable TV channels. (The CH No. will automatically increase when it appears.)

(START)



If you want to stop the EZ SETUP process once it has started, press **VOL -** and it will be canceled.

(STOP)



If you want to SET UP again, please refer to page 27 on SET UP.

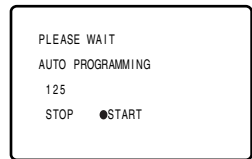

To cancel EZ SETUP

Press **VOL -**.

- Once EZ SETUP is complete, the lowest channel number memorized will be displayed.

2

Note:

- If EZ SETUP does not memorize all the channels in your region, please refer to pages 28–30 for more information on manually memorizing the channels using CHANNEL SETTING.
- It may be difficult to PRESET when the broadcast signals are weak, the channel cycle frequency is incorrect or frequency jamming is occurring around the area. Please refer to pages 28–30 for more information on manually memorizing the channels using CHANNEL SETTING.

Demo Mode

- To learn more about the TV set, you can enter DEMO mode. Simply press and hold **MENU** on the TV set for more than 3 seconds.
- To cancel DEMO mode, again press **MENU** on the TV set for more than 3 seconds.

Example:

DEMO mode display



(On the Set)

MENU



MENU
button

Accessing the MAIN MENU screen without Remote Control

- If you misplaced your Remote Control you can still access most settings via the MAIN MENU screen by pressing **MENU** on the TV set.
- Some features of your TV set are not accessible without the Remote Control. If you lost your Remote Control, contact a Sharp Service Center for a replacement.

(On the Set)

MENU



MENU
button

Language

- The language for the ON SCREEN DISPLAY can be set to ENGLISH, SPANISH or FRENCH.

1 Press **MENU** to access the MAIN MENU screen.

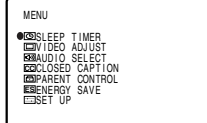

(MAIN MENU screen)

2 Press **CH ▲/▼** to move the “●” mark to “SET UP”.

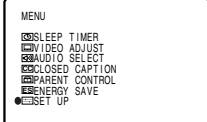

3 Press **VOL +/-** to access the SET UP screen, then press **CH ▲/▼** to move the “●” mark to “LANGUAGE”.

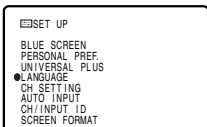
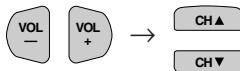

(SET UP screen)

4 Press **VOL +/-** to access the LANGUAGE select screen.

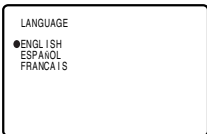
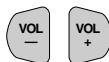

(LANGUAGE select screen)

5 Press **CH ▲/▼** to select “ENGLISH”, “ESPAÑOL (SPANISH)” or “FRANCAIS (FRENCH)”.

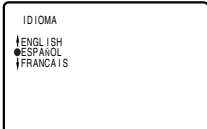

6 Press **MENU** to exit.



Sleep Timer

- You can preset your television to turn off automatically in increments of 30, 60, 90 or 120 minutes.

1 Press **MENU** to access the MAIN MENU screen.

2 Press **VOL +/-** to access the SLEEP TIMER screen.

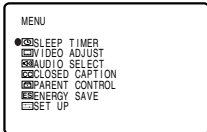
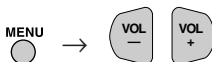

3 Press **VOL +/-** to set a sleep time of 30, 60, 90 or 120 minutes.

4 Press **MENU** to exit.

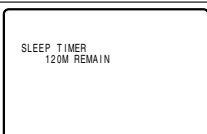

(SLEEP TIMER screen)

Note:

- To turn off the SLEEP TIMER, repeat the above SLEEP TIMER steps and select “--- M REMAIN” during step 3.
- While SLEEP TIMER is active, the time remaining will be briefly displayed on-screen at regular intervals or when the Remote’s **DISPLAY** key is pressed twice. 5 minutes before the SLEEP TIMER turns off the TV, the screen prompts the time remaining for 4 seconds. The SLEEP TIMER shows a similar display for each remaining minute and a 10-second display right before shutting off the TV.
- If you turn the POWER OFF, the SLEEP TIMER will automatically reset.

Video Adjust

• Description of Adjustment Items

Selected item	VOL + button	VOL - button
PICTURE	To increase contrast	To decrease contrast
TINT	To make skin tones greenish	To make skin tones purplish
COLOR	To increase color intensity	To decrease color intensity
BRIGHT	To increase brightness	To decrease brightness
SHARP	To increase sharpness	To decrease sharpness
COLOR TEMP.	To choose a LOW, ML, MH or HIGH color tone.	
RESET	To return all adjustments to factory preset levels.	

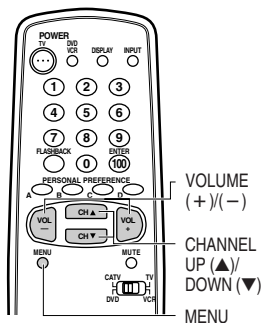

- 1 Press **MENU** to access the MAIN MENU screen.
- 2 Press **CH ▲/▼** to move the “●” mark to “VIDEO ADJUST”.

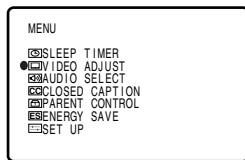
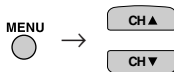

(MAIN MENU screen)

- 3 Press **VOL +/-** to access the PICTURE adjust screen.

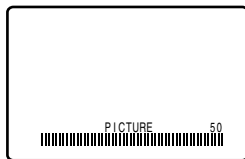
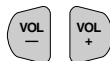

(PICTURE adjust screen)

- 4 Press **CH ▲/▼** to select the desired adjustment item. (Refer to the diagram below.)

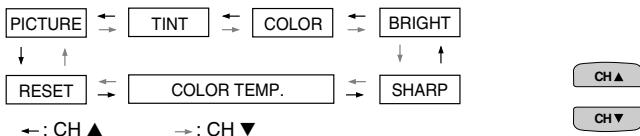

- 5 Press **VOL +/-** to adjust the setting.

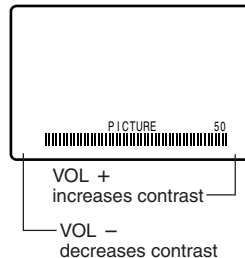
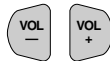

- 6 Repeat steps 4 to 5 to adjust other settings.

- 7 Press **MENU** to exit.



Note:

- VIDEO ADJUST setting, once set, is shared among AIR/CABLE, INPUT 1, INPUT 2, and INPUT 3 modes.
- VIDEO ADJUST setting for INPUT 3 when used as COMPONENT can be set independently.

Audio Select

■ MTS (Multichannel TV Sound)

This function allows reception of stereo or bilingual TV sound.

- You can enjoy Hi-Fi stereo sound or SAP broadcasts where available.

Stereo broadcasts

Live television broadcasts of sports, shows, concerts, etc. can be received in dynamic stereo sound.

SAP broadcasts

Television broadcast can be received with either MAIN or SAP sound.

MAIN sound: The normal program soundtrack. (Monaural or stereo where available.)

SAP sound: Second language, supplementary commentaries, etc. (SAP sound is monaural.)

- If stereo sound is difficult to hear;

You can obtain clearer sound by manually switching to fixed monaural mode.

■ SPEAKER (Internal Speaker Switch)

This function turns the TV's internal speakers "ON" or "OFF" when listening to sound from external speakers by using the AUDIO OUTPUT Terminals. (See page 40).

■ FAO (Fixed Audio Output)

This function turns the TV's internal speakers "OFF" and allows fixed audio output from the AUDIO OUTPUT Terminals. (See page 40). With FAO, the TV's volume control is disabled.

- 1 Press **MENU** to access the MAIN MENU screen.

- 2 Press **CH ▲/▼** to move the "●" mark to "AUDIO SELECT".

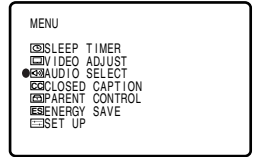
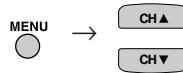

(MAIN MENU screen)

- 3 Press **VOL +/-** to access the AUDIO SELECT screen.

- 4 Press **CH ▲/▼** to move the "●" mark to "MTS", "SPEAKER", "FAO" or "AUDIO ADJUST".

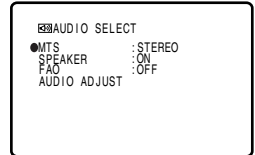
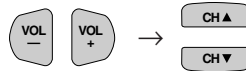

(AUDIO SELECT screen)

- 5 Press **VOL +/-** to select "STEREO", "SAP" or "MONO" when the "●" mark is at "MTS" position.

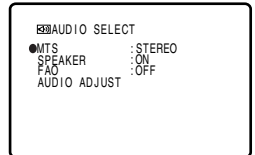
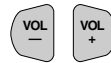
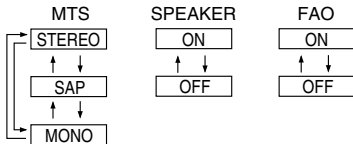

(AUDIO SELECT screen)

Audio Select (Continued)

AUDIO ADJUST

When the "●" mark is at "AUDIO ADJUST", press **VOL +/-** to access the AUDIO ADJUST screen. To access the desired item, press **CH ▲/▼**. To adjust the audio setting, press **VOL +/-**.

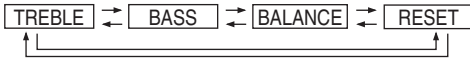

Selected item	VOL + button	VOL - button
TREBLE	To increase treble response.	To decrease treble response.
BASS	To increase bass response.	To decrease bass response.
BALANCE	To emphasize the right speaker's volume.	To emphasize the left speaker's volume.
RESET	To return all adjustments to factory preset levels.	

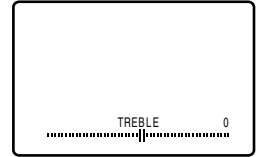

6 Press **MENU** to exit.



An example screen displaying ON AIR when receiving stereo broadcasts

Current channel number

"← ON AIR" will appear next to STEREO or SAP when receiving STEREO or SAP broadcasts.

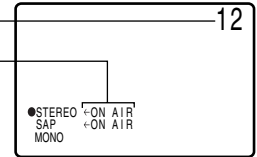

(CHANNEL call on screen)

Note:

- Once MONO mode is selected, the TV sound remains monaural even if the TV set receives a stereo broadcast. You must switch the mode back to STEREO if you want to hear stereo sound again.
- Selecting MTS while receiving video signals from INPUT terminals does not change the type of sound; in this case, sound is determined by the video source.
- If "FAO" mode is on, "SPEAKER" mode will automatically turn off. Changing "SPEAKER" setting will not affect "FAO" mode.

Closed Caption

● How to set CLOSED CAPTION

- Your TV is equipped with an internal Closed Caption decoder. "Closed Caption" is a system which allows conversations, narration, and sound effects in TV programs and home videos to appear as captions on the TV screen (see the illustration).
- Not all the programs and videos will offer closed captioning. Please look for the "CC" symbol to ensure that captions will be shown.
- Closed Caption broadcast can be viewed in two modes: CAPTION and TEXT. For each mode, two channels are available, CH1 and CH2.



The CAPTION mode shows subtitles of dialogs and commentaries of TV dramas and news programs while allowing clear view of the picture.

The TEXT mode displays over the picture other various information (such as TV program schedule, weather forecast, etc.) that is independent of the TV programs.

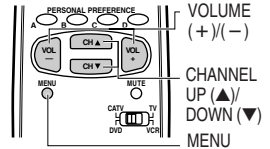

- 1 Press **MENU** to access the MAIN MENU screen.
- 2 Press **CH ▲/▼** to move the "●" mark to "CLOSED CAPTION".

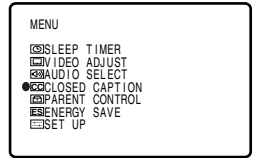
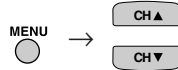

(MAIN MENU screen)

- 3 Press **VOL +/-** to access the CLOSED CAPTION setting screen.

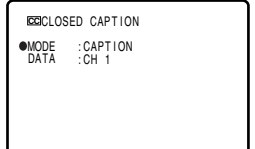
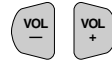

(CLOSED CAPTION setting screen)

- 4 Press **CH ▲/▼** to move the "●" mark to either "MODE" or "DATA".

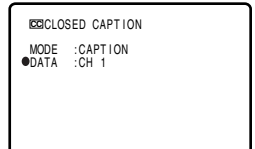

- 5 Press **VOL +/-** to change the CLOSED CAPTION setting.

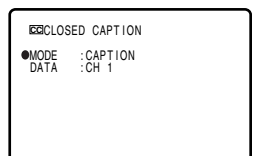
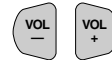
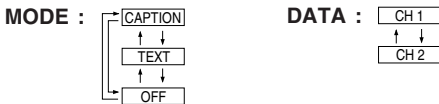

- 6 Press **MENU** to exit.



Note:

- If a broadcast contains CLOSED CAPTION and the **MUTE** button is pressed, the set enters CAPTION mode automatically. Pressing **MUTE** again will return the set to its previous condition.
- Closed Caption may malfunction (white blocks, strange characters, etc.) if signal conditions are poor or if there are problems at the broadcast source. This does not necessarily indicate a problem with your TV.
- If any button is pressed to call up the ON SCREEN DISPLAY while viewing a CLOSED CAPTION broadcast, the closed captions will disappear momentarily.
- If no TEXT broadcast is being received while viewing in the TEXT mode, the screen may become dark and blank for some programs. Should this occur, switch the Closed Caption mode to "OFF".

Parent Control (V-CHIP Operation)

V-CHIP

- This function allows you to restrict TV programs and also allows you to control TV usage based on FCC data. This function is to prevent your children from watching violence or sexual scenes that may be harmful.
- Restriction of TV programs includes two characters that contain information about the program's MPAA rating and the TV Parental Guidelines. MPAA is restricted by age. TV Parental Guidelines are restricted by age and contents.
- Since a TV program may use either the MPAA rating or the TV Guidelines you should adjust both for complete control.

[1] MPAA RATING

RATING		
age based	G	GENERAL AUDIENCES. All ages admitted.
	PG	PARENTAL GUIDANCE SUGGESTED. Some material may not be suitable for children.
	PG-13	PARENTS STRONGLY CAUTIONED. Some material may be inappropriate for children under 13.
	R	RESTRICTED. Under 17 requires accompanying parent or adult guardian.
	NC-17	NO ONE 17 AND UNDER ADMITTED.
	X	X Rating is an older rating that is unified with NC-17 but may be encoded on older movie's data.

MPAA RATING

Example 1:

"PG-13" in the age-based rating is blocked, this will automatically block the higher ratings "R", "NC-17", "X" also.

1. User setting	2. Block table
G -----	G not to block
PG -----	PG not to block
PG-13 BLOCK	PG-13 Select block
R BLOCK	R auto-block
NC-17 BLOCK	NC-17 auto-block
X BLOCK	X auto-block

age based

Example 2:

"R" in the age-based rating is blocked, this will automatically block the higher rating "NC-17", "X" also.

1. User setting	2. Block table
G -----	G not to block
PG -----	PG not to block
PG-13 -----	PG-13 not to block
R BLOCK	R Select block
NC-17 BLOCK	NC-17 auto-block
X BLOCK	X auto-block

age based

Note:

- MPAA RATING is only age-based.

[2] TV PARENTAL GUIDELINES

RATING	content based					
	AGE	D (Sexually Suggestive Dialog)	L (Adult Language)	S (Sexual Situation)	V (Violence)	FV (Fantasy Violence)
age based	TV-Y (All children)	<input checked="" type="checkbox"/>	-	-	-	-
	TV-Y7 (Direct to Older Children)	<input checked="" type="checkbox"/>	-	-	-	<input checked="" type="checkbox"/>
	TV-G (General Audience)	<input checked="" type="checkbox"/>	-	-	-	-
	TV-PG (Parental Guidance Suggested)	<input checked="" type="checkbox"/>	<input checked="" type="checkbox"/>	<input checked="" type="checkbox"/>	<input checked="" type="checkbox"/>	-
	TV-14 (Parents Strongly Cautioned)	<input checked="" type="checkbox"/>	<input checked="" type="checkbox"/>	<input checked="" type="checkbox"/>	<input checked="" type="checkbox"/>	-
TV-MA (Mature Audience Only)	<input checked="" type="checkbox"/>	-	<input checked="" type="checkbox"/>	<input checked="" type="checkbox"/>	<input checked="" type="checkbox"/>	-

: Content Rating can be set.

- : Content Rating cannot be set (not normally broadcast by TV station).

Parent Control (V-CHIP Operation) (Continued)

• TV PARENTAL GUIDELINES (Example)

Example 1.1 : Age Based setting

Clear s (block) from each "AGE" box for all ratings.
This will automatically unblock everything.

	AGE	D	L	S	V	FV	
TV-Y	<input type="checkbox"/>	-	-	-	-	-	<input type="checkbox"/> VIEW
TV-Y7	<input type="checkbox"/>	-	-	-	-	-	<input type="checkbox"/> BLOCK
TV-G	<input type="checkbox"/>	-	-	-	-	-	
TV-PG	<input type="checkbox"/>	-	-	-	-	-	
TV-14	<input type="checkbox"/>	-	-	-	-	-	
● TV-MA	<input type="checkbox"/>	-	-	-	-	-	

MENU : RETURN

Example 1.2 : Age Based setting

For "TV-G" put a in the "AGE" box. This will automatically block the higher age ratings "TV-PG", "TV-14" and "TV-MA" as well as "TV-G".
Please note the content ratings "D", "L", "S", "V" are automatically blocked as well.

	AGE	D	L	S	V	FV	
TV-Y	<input type="checkbox"/>	-	-	-	-	-	<input type="checkbox"/> VIEW
TV-Y7	<input type="checkbox"/>	-	-	-	-	-	<input type="checkbox"/> BLOCK
● TV-G	<input type="checkbox"/>	-	-	-	-	-	
TV-PG	<input type="checkbox"/>	<input type="checkbox"/>	<input type="checkbox"/>	<input type="checkbox"/>	<input type="checkbox"/>	<input type="checkbox"/>	
TV-14	<input type="checkbox"/>	<input type="checkbox"/>	<input type="checkbox"/>	<input type="checkbox"/>	<input type="checkbox"/>	<input type="checkbox"/>	
TV-MA	<input type="checkbox"/>	<input type="checkbox"/>	<input type="checkbox"/>	<input type="checkbox"/>	<input type="checkbox"/>	<input type="checkbox"/>	

MENU : RETURN

Example 2.1 : Content Based setting

If you choose to unblock every content-based items ("D", "L", "S", "V"), clear the (block) from each "AGE" box of "TV-PG", "TV-14" and "TV-MA".

	AGE	D	L	S	V	FV	
TV-Y	<input type="checkbox"/>	-	-	-	-	-	<input type="checkbox"/> VIEW
TV-Y7	<input type="checkbox"/>	-	-	-	-	-	<input type="checkbox"/> BLOCK
TV-G	<input type="checkbox"/>	-	-	-	-	-	
TV-PG	<input type="checkbox"/>	-	-	-	-	-	
TV-14	<input type="checkbox"/>	-	-	-	-	-	
● TV-MA	<input type="checkbox"/>	-	-	-	-	-	

MENU : RETURN

Example 2.2 : Content Based setting

Put a in the box corresponding to "TV-PG" (row) and "V (Violence)" (column). This will automatically block the "V" boxes for "TV-14" and "TV-MA". Setting only "TV-PG-V", "TV-14-V" or "TV-MA-V" will not block all programs rated "TV-PG", "TV-14" or "TV-MA".

	AGE	D	L	S	V	FV	
TV-Y	<input type="checkbox"/>	-	-	-	-	-	<input type="checkbox"/> VIEW
TV-Y7	<input type="checkbox"/>	-	-	-	-	-	<input type="checkbox"/> BLOCK
TV-G	<input type="checkbox"/>	-	-	-	-	-	
● TV-PG	<input type="checkbox"/>	-	-	-	<input type="checkbox"/>	-	
TV-14	<input type="checkbox"/>	-	-	-	<input type="checkbox"/>	-	
TV-MA	<input type="checkbox"/>	-	-	-	<input type="checkbox"/>	-	

MENU : RETURN

Example 3 : Resetting an Age Based setting

For "TV-14", put a (block) in the "AGE" box.

This will again automatically block the content ratings "D", "L", "S", "V" for "TV-MA" as well as "TV-14" ("D" is not available for "TV-MA").

Please note that the lower age rating "TV-PG" does not change from its previous settings after this.

	AGE	D	L	S	V	FV	
TV-Y	<input type="checkbox"/>	-	-	-	-	-	<input type="checkbox"/> VIEW
TV-Y7	<input type="checkbox"/>	-	-	-	-	-	<input type="checkbox"/> BLOCK
TV-G	<input type="checkbox"/>	-	-	-	-	-	
TV-PG	<input type="checkbox"/>	-	-	-	-	-	
● TV-14	<input type="checkbox"/>	-	-	-	-	-	
TV-MA	<input type="checkbox"/>	-	-	-	-	-	

MENU : RETURN

Note

- Content ratings can be modified but only in the combinations indicated by in the table on page 15.
- Changing a lower age rating's content setting to "BLOCK" automatically changes the same higher age rating's content setting to "BLOCK" regardless of their previous settings.
- Changing a lower rating's "AGE" setting to "BLOCK" automatically changes all higher ratings to "BLOCK" regardless of their previous settings.
- For "TV-Y7", "TV-PG", "TV-14" and "TV-MA", if you clear the in the "AGE" box (unblock) you can still change settings based on content.
- Clearing a higher rating's age or content setting will not clear lower settings. Make sure that all undesired boxes are blocked.

[3] ADDITIONAL MODE

Besides "MPAA RATINGS" and "TV PARENTAL GUIDELINES", new ratings system's data can be downloaded when they become available. (See page 19.)

Parent Control (V-CHIP Operation) (Continued)

● How to set V-CHIP

[1] MPAA RATING

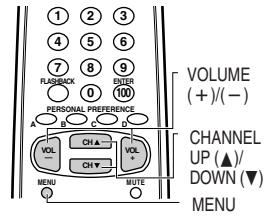

1 Press **MENU** to access the MAIN MENU screen.

MENU

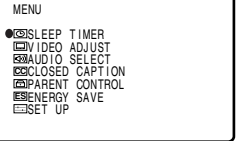

(MAIN MENU screen)

2 Press **CH ▲/▼** to move the “●” mark to “PARENT CONTROL”.

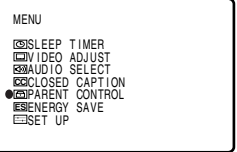

3 Press **VOL +/-** to access the PARENT CONTROL screen.

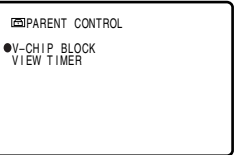
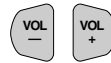

(PARENT CONTROL screen)

4 Press **VOL +/-** to access the V-CHIP select screen.

Note: ➤

- If SECRET No. is already set, enter the SECRET No. (See ● **To change the V-CHIP BLOCK after registering a secret No.** on page 22.).

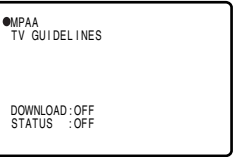
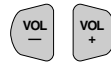

(V-CHIP select screen)

5 Press **VOL +/-** to select “MPAA”. Press **CH ▲/▼** to move the “●” mark to “PG”, then press **VOL +/-** to select BLOCK. If you set “PG” to BLOCK, “PG-13”, “R”, “NC-17” and “X” are automatically blocked.

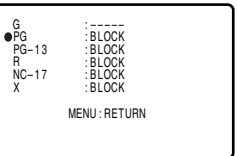

6 Press **MENU** to return to the V-CHIP select screen.

MENU



Parent Control (V-CHIP Operation) (Continued)

7 Press **MENU**, then "INPUT SECRET No." will be displayed.

Note:

- If SECRET No. is already set, skip to step 9.



8 Enter a 4-digit SECRET No. using the **REMOTE KEYPAD**.

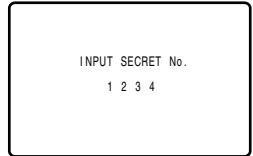

9 When done, press **MENU** to exit.



Note:

- If you set "G" to BLOCK, all ratings are automatically blocked.
- If you set "X" to BLOCK, "G", "PG", "PG-13", "R" and "NC-17" are not blocked.

[2] TV GUIDELINES

1 Repeat steps 1 to 4 of [1] **MPAA RATING**.

2 Press **CH ▲/▼** to move the "●" mark to "TV GUIDELINES".

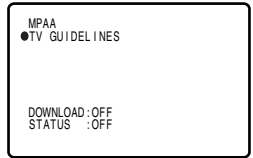

(V-CHIP select screen)

3 Press **VOL +/-** to access the TV GUIDELINES screen.

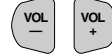

4 To change AGE and CONTENT SETTING, press **CH ▲/▼** to move the "●" mark to the desired rating and then press **VOL +/-** to select.

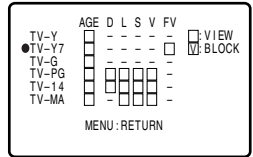
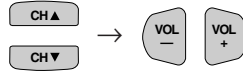

(TV GUIDELINES screen)

5 Press **CH ▲/▼** to move the "●" mark to the desired content item and then press **VOL +/-** to select either "BLOCK" or "-----" (unlock).

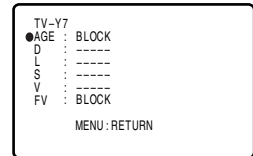
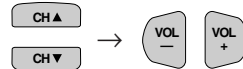

(CONTENT RATING screen)

6 Press **MENU** to return to the TV GUIDELINES screen.

7 Repeat steps 4 to 6 until all ratings and their contents are set.

8 When done, press **MENU** to return to V-CHIP select screen.

9 Press **MENU** to exit.

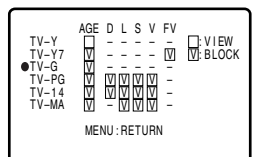

Note:

- If SECRET No. is not set, enter a SECRET No. as show in steps 7 and 8 of [1] **MPAA RATING**.

Parent Control (V-CHIP Operation) (Continued)

[3] Downloading additional rating mode

There will be an additional new rating system. In that case, please set up as follows. Subsequently the new rating system will set up automatically.

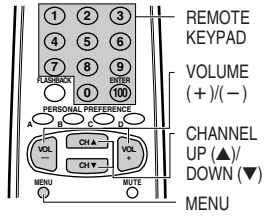

1 Repeat steps 1 to 4 of [1] MPAA RATING.

2 Press **CH ▲/▼** to move the “●” mark to “DOWNLOAD”.

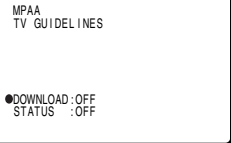

3 Press **VOL +/-** to select “DOWNLOAD : ON”.

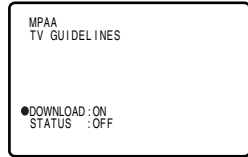
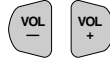

4 Press **MENU**, then “INPUT SECRET No.” will be displayed.

Note:

- If SECRET No. is already set, skip to step 6.

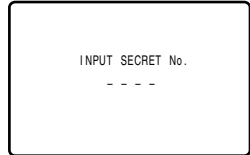

5 Enter a 4-digit secret No. using the **REMOTE KEYPAD**.

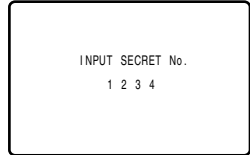

6 Press **MENU** to exit.



• Downloading V-CHIP data

1 If you watch a program containing “new rating system data”, the DOWNLOAD screen will be displayed.



(DOWNLOAD screen)

2 The DOWNLOAD screen will disappear, once downloading is finished.

Note:

- DOWNLOAD will not start, if you are not watching a program containing “new rating system data”.

Parent Control (V-CHIP Operation) (Continued)

• How to set additional rating mode (Example)

Once downloading is complete, you can set the blocking pattern as follows.

1 Repeat steps 1 to 4 of [1] MPAA RATING.

2 Press **CH ▲/▼** to move the "●" mark to "Cdn. English Ratings", then press **VOL +/-**.

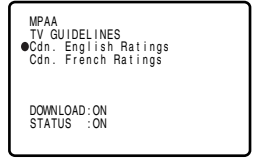
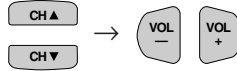

(After downloading the rating data)

3 You can select "BLOCK" or "-----" (unblock) for each rating item by pressing **CH ▲/▼** and **VOL +/-**.

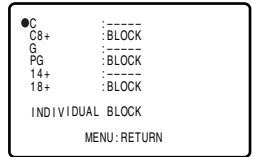
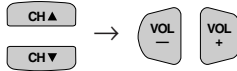

(ENGLISH INDIVIDUAL BLOCK screen)

4 You can select "BLOCK" or "-----" (unblock) for each rating item by pressing **CH ▲/▼** and **VOL +/-** if you select "Cdn. French Ratings" in step 2.

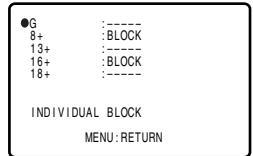
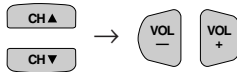

(FRENCH INDIVIDUAL BLOCK screen)

Note:

- You are able to download up to 4 different rating systems.

Parent Control (V-CHIP Operation) (Continued)

● Activating the V-CHIP BLOCK

1 Repeat steps 1 to 4 of [1] MPAA RATING.

2 Press **CH ▲/▼** to move the "●" mark to "STATUS". Press **VOL + / -** to activate the V-CHIP BLOCK. (If STATUS is OFF, V-CHIP BLOCK will not operate.)

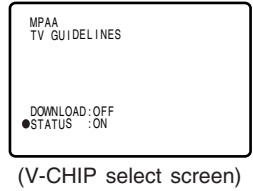
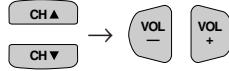

3 Press **MENU**, then "INPUT SECRET No." will be displayed.

Note:

• If SECRET No. is already set, skip to step 5.

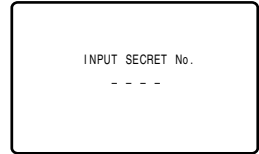

4 Enter a 4-digit secret No. using the **REMOTE KEYPAD**.

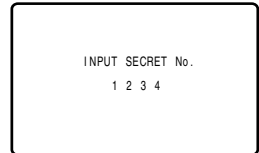

5 Press **MENU** and the secret No. will be registered.



● To temporarily cancel the V-CHIP BLOCK

1 "V-CHIP HAS BEEN ACTIVATED" appears if you view a program with the same program rating data you configured.

Note:

• "V-CHIP HAS BEEN ACTIVATED" will not be displayed if STATUS is not configured to "ON".



2 Press **MENU**, then "INPUT SECRET No." will be displayed.

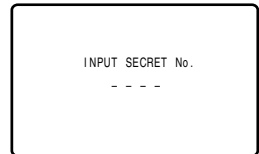

3 Enter the 4-digit secret No. using the **REMOTE KEYPAD**, then V-CHIP BLOCK will be canceled temporarily. If the wrong secret No. is chosen, "SECRET No. IS INCORRECT" will be displayed. Input the secret No. again in this case.

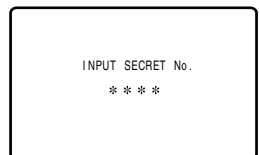

Note:

• If you turn the power ON from OFF, the V-CHIP BLOCK will be activated again.

Parent Control (V-CHIP Operation) (Continued)

● To change the V-CHIP BLOCK after registering a secret No.

- 1 Repeat steps 1 to 4 of [1] MPAA RATING, then "INPUT SECRET No." will be displayed.

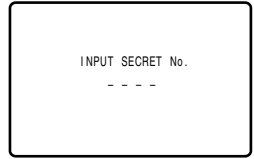

- 2 Enter the 4-digit secret No. using the **REMOTE KEYPAD** and the V-CHIP select screen will be displayed. Set V-CHIP BLOCK again.

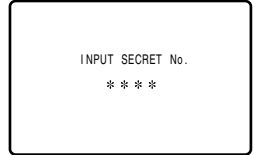

● If you forget or need to change your secret No., clear the original secret No. and set up a new one.

- 1 Repeat steps 1 to 4 of [1] MPAA RATING, or 1 to 2 of To temporarily cancel the V-CHIP BLOCK, then "INPUT SECRET No." will be displayed.

- 2 Press and hold both **VOL +** and **CH ▲** on the TV set simultaneously until the message "INPUT SECRET No." disappears.

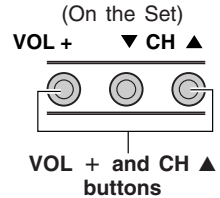

- 3 Press the **MENU** button twice to exit.



Parent Control (VIEW TIMER)

VIEW TIMER

This function allows you to restrict TV viewing time and also allows you to control TV usage. This function is to prevent your children from watching too much TV.

VIEWING TIME (an accumulative timer: counts only the time duration while the TV power is on.)

- VIEWING TIME can be set from 30M (30 minutes) to 10H00M (10 hours) in 30 minutes intervals.

OFF TIME (Restricts TV viewing after the VIEWING TIME reaches zero.)

- OFF TIME can be set from 30M (30 minutes) to 10H00M (10 hours) in 30 minutes intervals.

STATUS (Select ON to activate VIEW TIMER)

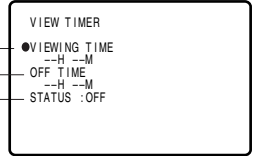

How to set VIEW TIMER

- Press **MENU** to access the MAIN MENU screen.
- Press **CH ▲/▼** to move the “●” mark to “PARENT CONTROL”.

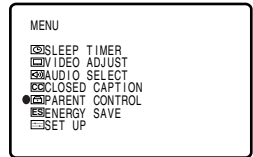
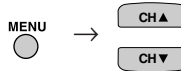

(MAIN MENU screen)

- Press **VOL +/-** to access the PARENT CONTROL screen.
- Press **CH ▲/▼** to move the “●” mark to “VIEW TIMER”.

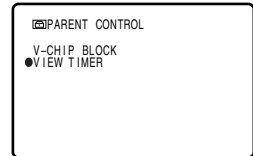
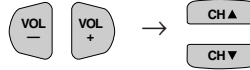

(PARENT CONTROL screen)

- Press **VOL +/-** to access “VIEW TIMER”.

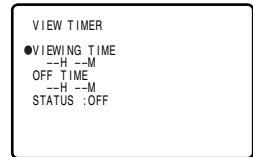
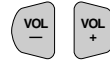

- Press **CH ▲/▼** to select “VIEWING TIME” and “OFF TIME”. For each selection, press the **VOL +/-** to set the time duration.

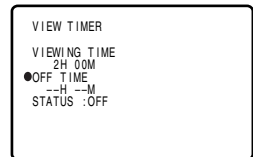
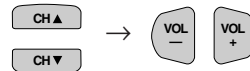

- Press **CH ▲/▼** to select “STATUS”. Press the **VOL +/-** to turn ON the “VIEW TIMER”. (If STATUS is OFF, VIEW TIMER will not operate.)

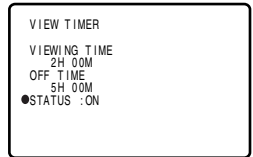
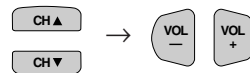

- Press **MENU**. “INPUT SECRET No.” will be displayed.

Note:

- If SECRET No. is already set, skip to step 10.

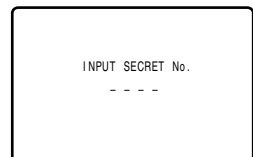

Parent Control (VIEW TIMER) (Continued)

9 Enter a 4-digit SECRET No. using the **REMOTE KEYPAD**.

10 Press **MENU** to exit.

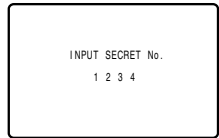
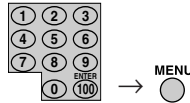

Example:

- To restrict anybody from watching TV for more than 5 hours, after watching the TV for 2 hours, your settings would look like the one on the right.
- You can choose to watch the 2 hours of TV as you wish. For example, you could watch 1 hour of TV, turn the TV off for 30 minutes, then turn the TV on and watch the remaining 1 hour of the VIEWING TIME.

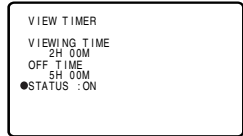

To change the VIEW TIMER setting after registering a secret No.

1 Repeat steps 1 to 4 of **How to set VIEW TIMER**. Press **VOL +/-**, and "INPUT SECRET No." will be displayed.

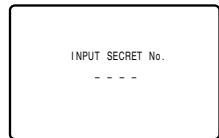
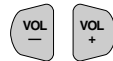

2 Enter the 4-digit SECRET No. using the **REMOTE KEYPAD**, and the VIEW TIMER access screen will be displayed. Repeat steps **5, 6**.



Note:

- When you choose the correct secret No., the VIEW TIMER access screen is displayed. If the wrong secret No. is chosen, "SECRET No. IS INCORRECT" is displayed. Input the secret No. again in this case.

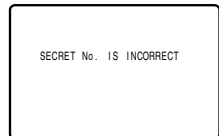

To cancel the VIEW TIMER (While the TV set is OFF but the VIEW TIMER is set.)

1 Turn on the TV; a blue screen message "TIME OVER" will appear. If you do nothing, the TV will turn off in approximately 30 seconds.

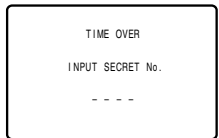

2 Enter the 4-digit secret No. using the **REMOTE KEYPAD**. When you choose the correct secret No., the VIEW TIMER is canceled. If the wrong secret No. is chosen, "SECRET No. IS INCORRECT" is displayed. Input the secret No. again in this case.

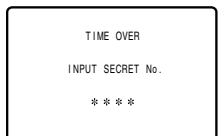

Parent Control (VIEW TIMER) (Continued)

- To cancel the VIEW TIMER setting or change the secret No. (If you forget the SECRET No.)

- Repeat steps 1 to 4 of **How to set VIEW TIMER**. Press **VOL +/-**, and "INPUT SECRET No." will be displayed.

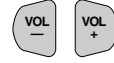

- Press and hold both **VOL +** and **CH ▲** on the TV set simultaneously until the VIEW TIMER access screen is displayed. Now you can cancel the VIEW TIMER settings or change the SECRET No. while "INPUT SECRET No." is displayed.

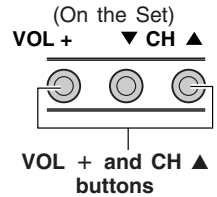

• Notice of Remaining VIEWING TIME

- For every 30 minute interval, the remaining time will be displayed for 4 seconds. For the last 5 minutes, the remaining time will be displayed every minute.
- "0 REMAIN" will be displayed for 10 seconds just before the VIEWING TIME expires.

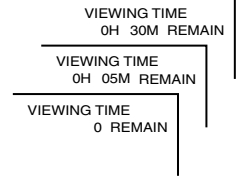

Energy Save

- This feature lets you lower the power consumption of your TV set which in turn saves you money and minimizes the impact on the environment. When this feature is turned on, it reduces the brightness of the TV to a level that consumes approximately 20 percent less energy than when the feature is turned off. The reduction in brightness will be less noticeable under low room lighting conditions.

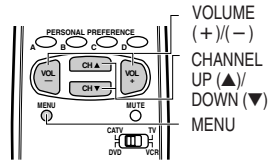

- Press **MENU** to access the MAIN MENU screen.
- Press **CH ▲/▼** to move the “●” mark to “ENERGY SAVE”.

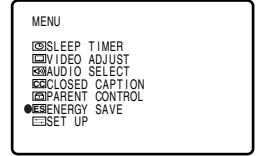
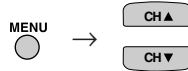

(MAIN MENU screen)

- Press **VOL +/-** to access the ENERGY SAVE select screen.

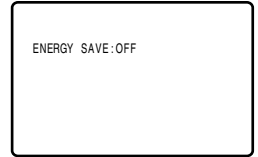
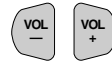

(ENERGY SAVE select screen)

- Press **VOL +/-** to select “ON”.

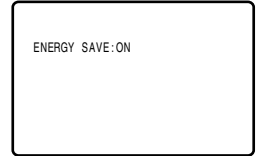
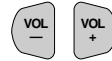

- Press **MENU** to exit.



Set Up

EZ Setup

By operating the channel preset functions, you can preset your TV to the desired channels for viewing.

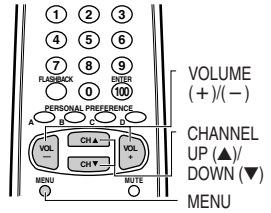

- 1 Press **MENU** to access the MAIN MENU screen.
- 2 Press **CH ▲/▼** to move the “●” mark to “SET UP”.

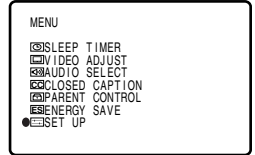
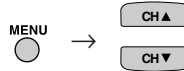

(MAIN MENU screen)

- 3 Press **VOL +/-** to access the SET UP screen, then press **CH ▲/▼** to move the “●” mark to “CH SETTING”.

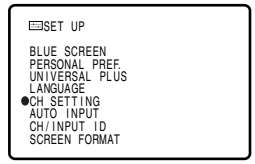
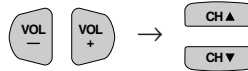

(SET UP screen)

- 4 Press **VOL +/-** to access the CH SETTING screen.

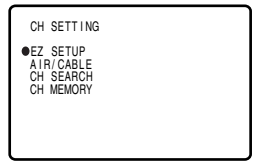
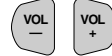

(CH SETTING screen)

- 5 Press **VOL +/-** to access the EZ SETUP screen.

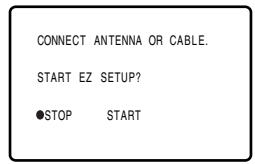
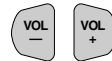

(EZ SETUP screen)

- 6 Press **VOL +**.
The tuner will automatically search for the broadcasting and cable TV channels. (The CH No. will automatically increase when it appears.)

If you want to stop the EZ SETUP process once it has started, press **VOL -**. Search will be canceled.

To cancel EZ SETUP
Press **VOL -**.

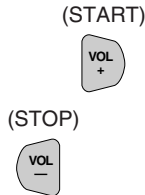

- 7 Once EZ SETUP is complete, the lowest channel number memorized will be displayed.



Set Up (Continued)

Channel Setting

If EZ SETUP does not memorize all the channels in your region, follow the instructions below to manually memorize the channel.

1 Press **MENU** to access the MAIN MENU screen.

2 Press **CH ▲/▼** to move the “●” mark to “SET UP”.

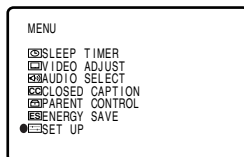
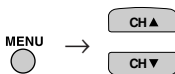

(MAIN MENU screen)

3 Press **VOL +/-** to access the SET UP screen.

4 Press **CH ▲/▼** to move the “●” mark to “CH SETTING”.

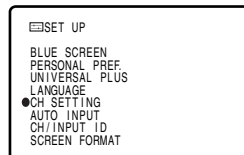
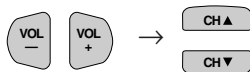

(SET UP screen)

5 Press **VOL +/-** to access the CH SETTING screen.

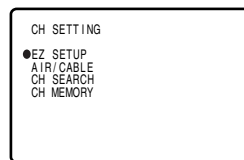
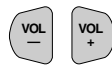

(CH SETTING screen)

6 Press **CH ▲/▼** to move the “●” mark to “AIR/CABLE”, then press **VOL +/-** to access the AIR/CABLE screen.

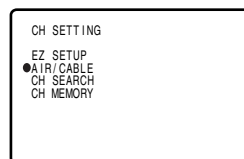
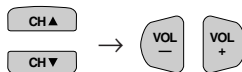

7 Press **CH ▲/▼** to move the “●” mark to the desired mode.

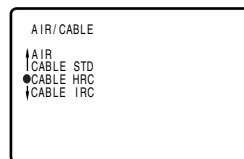
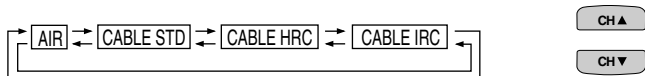

(AIR/CABLE screen)

8 Press **MENU** to exit.



Note:

- Receivable channels of your TV set are:
 AIR channels:
 VHF: 2 through 13.
 UHF: 14 through 69.

- CABLE channels:
 1 (HRC and IRC mode only)
 2 through 125 (STD, HRC and IRC)

Set Up (Continued)

● Saving broadcast TV channels into memory

1 Press **MENU** to access the MAIN MENU screen, then press **CH ▲/▼** to move the “●” mark to “SET UP”.

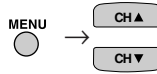

2 Press **VOL +/-** to access the SET UP screen, then press **CH ▲/▼** to move the “●” mark to “CH SETTING”.

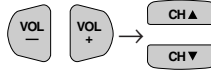

3 Press **VOL +/-** to access the CH SETTING screen.

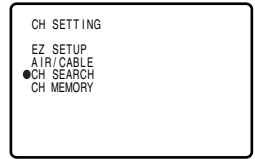
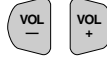

(CH SETTING screen)

4 Press **CH ▲/▼** to move the “●” mark to “CH SEARCH”, then press **VOL +/-** to access the CH SEARCH screen.

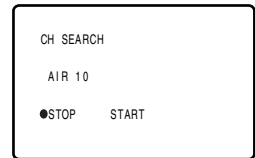
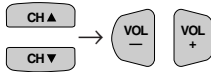

(CH SEARCH screen)

To start:

Press **VOL +**. The tuner will search through all available channels in your area and add them into the TV memory.

(START)



To stop:

Press **VOL -**. CH SEARCH will stop at the current channel and will not add any higher channels.

(STOP)



5 Press **MENU** to exit.



Note:

- If you press **VOL +** again while in the CH SEARCH mode, auto-program will start again, and the previously memorized channels will be lost.

● Adding weak or additional channels or erasing unwanted channels from TV memory

1 Press **MENU** to access the MAIN MENU screen, then press **CH ▲/▼** to move the “●” mark to “SET UP”.

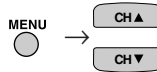

2 Press **VOL +/-** to access the SET UP screen, then press **CH ▲/▼** to move the “●” mark to “CH SETTING”.

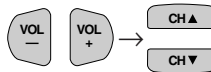

3 Press **VOL +/-** to access the CH SETTING screen.

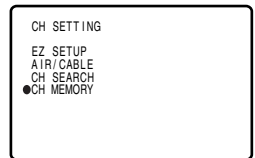
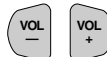

(CH SETTING screen)

4 Press **CH ▲/▼** to move the “●” mark to “CH MEMORY”, then press **VOL +/-** to access the CH MEMORY screen.

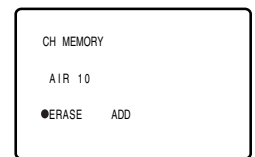
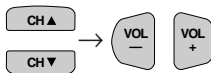

(CH MEMORY screen)

5 Use **CH ▲/▼** or **REMOTE KEYPAD** to select each desired channel to add or erase.

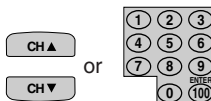

Set Up (Continued)

- 6 Press **VOL +** to add a channel to the TV memory or press **VOL -** to erase a channel from the TV memory.

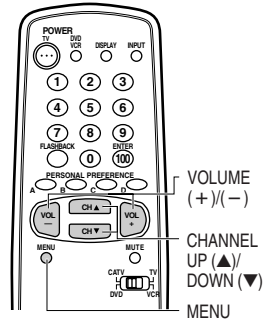
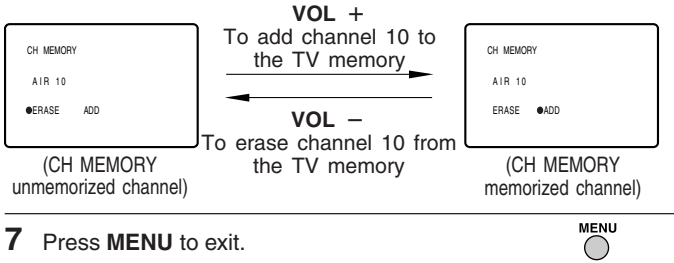

- 7 Press **MENU** to exit.

BLUE SCREEN

Automatically turns the screen blue if a broadcast signal is not received. After 15 minutes of non-reception, the TV will turn off automatically.

- 1 Press **MENU** to access the MAIN MENU screen.
- 2 Press **CH ▲/▼** to move the “●” mark to “SET UP”.

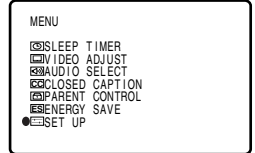
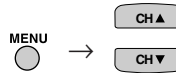

(MAIN MENU screen)

- 3 Press **VOL +/-** to access the SET UP screen.

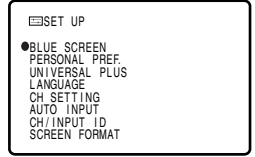
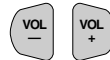

(SET UP screen)

- 4 Press **VOL +/-** to access the BLUE SCREEN select screen.

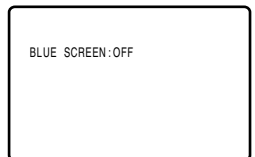
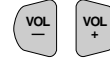

(BLUE SCREEN select screen)

- 5 Press **VOL +/-** to select “ON”.

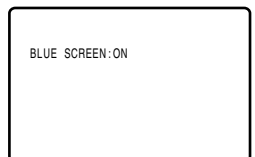

Set Up (Continued)

- 6 Press **MENU** to exit.

MENU



When the BLUE SCREEN is set to "ON"

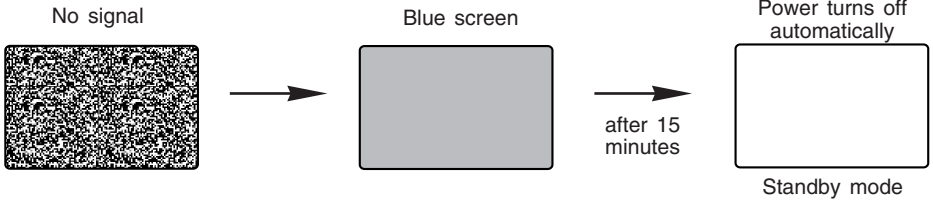

Note:

- Poor reception due to weak signals, or too much noise might activate the BLUE SCREEN function despite the presence of a broadcast signal. To continue watching TV under these conditions, switch the BLUE SCREEN "OFF".
- While INPUT 1, 2, or 3 (COMPONENT) is selected, the BLUE SCREEN will not be shown even if BLUE SCREEN is turned on.

Set Up (Continued)

Personal Preference

By setting **PERSONAL PREFERENCE** channels in advance, you can select your favorite channels easily.

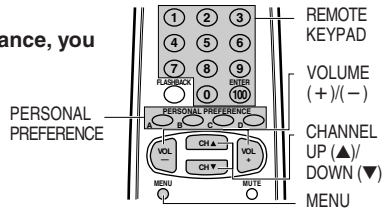

- 1 Press **MENU** to access the MAIN MENU screen.
- 2 Press **CH ▲/▼** to move the "●" mark to "SET UP".

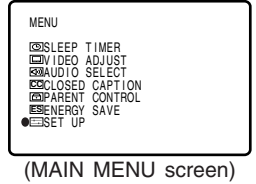
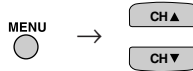

- 3 Press **VOL +/-** to access the SET UP screen, then press **CH ▲/▼** to move the "●" mark to "PERSONAL PREF".

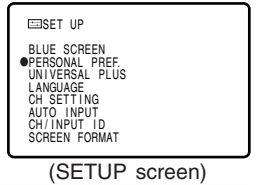
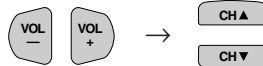

- 4 Press **VOL +/-** to select the PERSONAL PREFERENCE select screen in which you can program 4 favorite channels, in 4 different categories. (total of 16 channels)

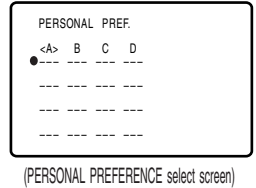
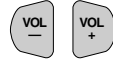

- 5 Press **VOL +/-** and **CH ▲/▼** to move the "●" mark to the desired position.

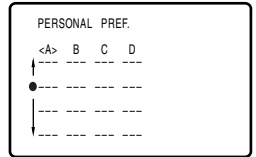

- 6 Press **REMOTE KEYPAD** on the Remote to input the CHANNEL Number into memory. Press **INPUT** on the Remote to register the INPUT mode into memory.

Example: 125 — Press "100" followed by "2" and then "5".
 25 — Press "2" and then "5".
 4 — Press "0" and then "4".

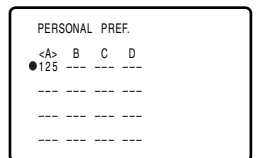

To reset a registered CHANNEL Number, input "0" twice.

- 7 Repeat steps 5 and 6 to register the next CHANNEL Number or INPUT mode.

- 8 Press **MENU** to exit.



To select the **PERSONAL PREFERENCE** channel.

If the channels are memorized as shown on the right, press the Remote's "A" button to select the channels below.

→ 125 → 25 → 40 → 4

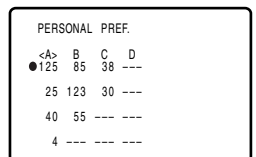

Set Up (Continued)

■ Universal Plus Function

VCR or DVD input mode will be selected automatically by pressing the VCR/DVD PLAY button on the Remote Control.

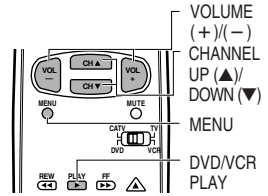

- 1 Press **MENU** to access the MAIN MENU screen.
- 2 Press **CH ▲/▼** to move the “●” mark to “SET UP”.

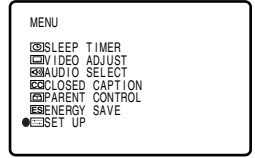
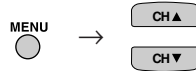

(MAIN MENU screen)

- 3 Press **VOL +/-** to access the SET UP screen.

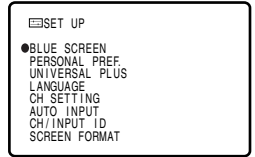
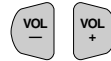

(SET UP screen)

- 4 Press **CH ▲/▼** to move the “●” mark to “UNIVERSAL PLUS”.

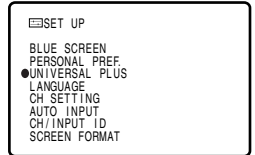

- 5 Press **VOL +/-** to access the UNIVERSAL PLUS select screen to select VCR or DVD mode.

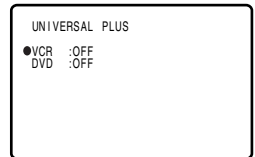
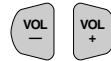

(UNIVERSAL PLUS select screen)

- 6 Press **CH ▲/▼** to select the VCR or DVD, and press **VOL +/-** to select “CH3”, “CH4”, “INPUT 1”, “INPUT 2”, “INPUT 3 (COMPONENT)” or “OFF”.

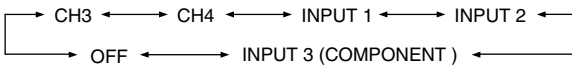

Switch to the input mode your VCR or DVD is connected to. If connected through RF (antenna terminal), select either CH3 or CH4 to match the setting of the VCR or DVD.

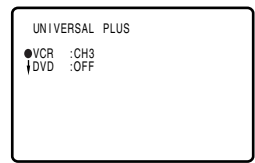
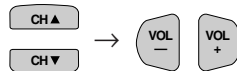

- 7 Press **MENU** to exit.



Auto Input

- The unit is preset to switch to the INPUT 2 screen automatically when VIDEO equipment is connected to the INPUT 2 terminal. Do the following to switch this feature off:

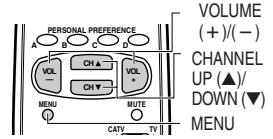

- 1 Press **MENU** to access the MAIN MENU screen.
- 2 Press **CH ▲/▼** to move the “●” mark to “SET UP”.

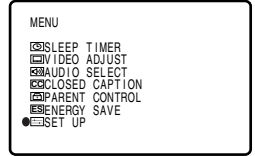
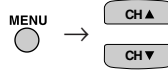

(MAIN MENU screen)

- 3 Press **VOL +/-** to access the SET UP screen, then press **CH ▲/▼** to move the “●” mark to “AUTO INPUT”.

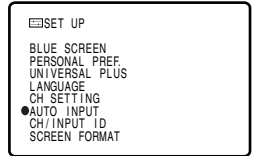

(SET UP screen)

- 4 Press **VOL +/-** to access the AUTO INPUT select screen.
Press **VOL +/-** to select “AUTO”.

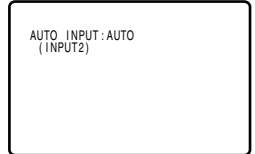
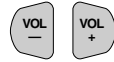

(AUTO INPUT select screen)

- 5 You may turn off “AUTO INPUT” when it is not in use.
Press **VOL +/-** to select “OFF”.

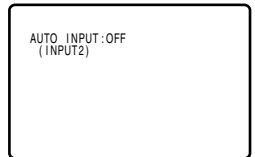
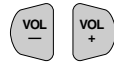

- 6 Press **MENU** to exit.



CH/Input ID

- You can assign an ID label to each channel or input mode. These ID labels can be 4 characters long maximum and will be displayed along with the channel number/input mode when the labeled channel is selected.
(Example: labeling air channel 10 “TV12”.)

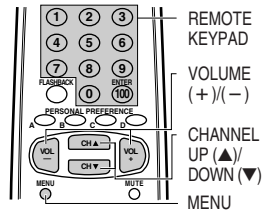

- Press **MENU** to access the MAIN MENU screen.

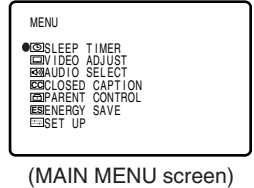

- Press **CH ▲/▼** to move the “●” mark to “SET UP”.

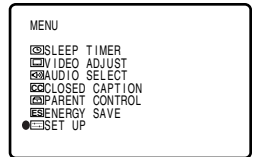

- Press **VOL +/-** to access the SET UP screen then press **CH ▲/▼** to move the “●” mark to “CH/INPUT ID”.

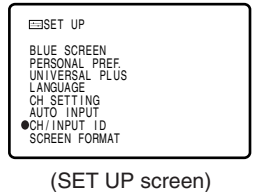
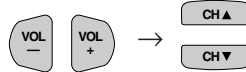

- Press **VOL +/-** to access the CH/INPUT ID screen.

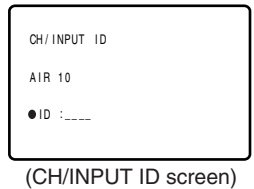
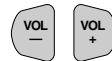

CH/Input ID (Continued)

- 5 Use **CH ▲/▼** or **REMOTE KEYPAD** to select each desired channel to label.
Press **INPUT** on the Remote to label the INPUT mode.

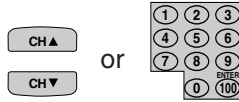

ID: Labeling the channel name

Press **VOL +/-** to select “ID” then press **VOL +** to select the first character. Press **CH ▲/▼** to enter a desired letter. Press **VOL +/-** to enter the next desired letter. Press **MENU** to return to the CH/INPUT ID screen.

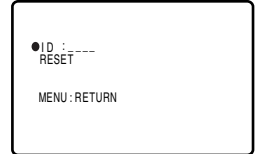
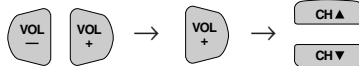

(ID Input screen)

Selectable characters:

Space: _

Alphabets: A-Z

Numbers: 0-9

Symbols: — . & () / +

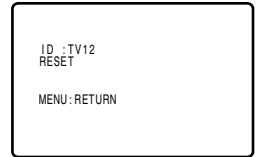

Example TV 12

RESET: Resetting the ID to “----”

Press **CH ▲/▼** to move the “●” mark to “RESET”, then press **VOL +/-**. The previously set ID will return to “----”.

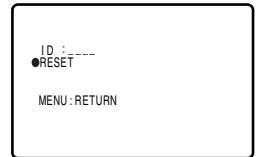
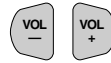
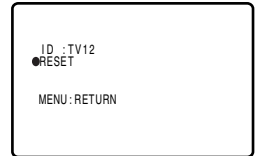

- 6 Press **MENU** to exit.



Note: ➤

- The maximum number of ID labels available to register channel names is 20 for AIR channels and 40 for CABLE channels.
- If you wish to register a new ID when all the available ID labels are assigned, delete a registered ID to make room.

Screen Format

- The format of the picture can be adjusted to either of the two screen formats.

(This function allows you to view 16:9 pictures recorded on DVD or by camcorders that are once saved using the 4:3 aspect ratio to be played back in the original high-density 16:9 format.)

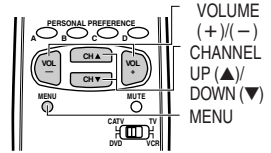

- Press **MENU** to access the MAIN MENU screen.
- Press **CH ▲/▼** to move the “●” mark to “SET UP”.

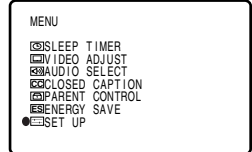
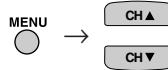

(MAIN MENU screen)

- Press **VOL +/-** to access the SET UP screen, then press **CH ▲/▼** to move the “●” mark to “SCREEN FORMAT”.

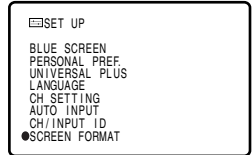
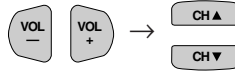

(SET UP screen)

- Press **VOL +/-** to access the SCREEN FORMAT select screen.

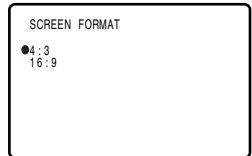
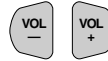

(SCREEN FORMAT select screen)

- Press **CH ▲/▼** to select “4:3” or “16:9”.

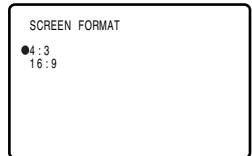

- Press **MENU** to exit.



Note:

The 16:9 screen format will be cancelled when the power is turned off.

Example:

While in 4:3 mode, if the picture appears stretched vertically as in screen A below, switch to 16:9 mode. The picture will return to normal as shown in screen B.

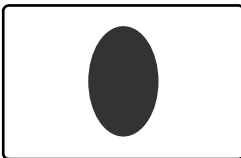

Screen A (4:3)

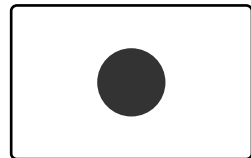

Screen B (16:9)

Using the Video and Audio Input Terminals

- Connecting video equipment for playback of video material.
- To view video material from external video equipment, make sure to connect the equipment properly to the input terminals on the TV set.

Connecting video device equipped with video output terminals

CONNECTIONS

VIDEO EQUIPMENT

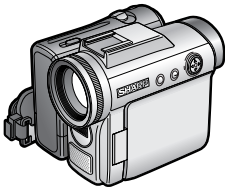

CAMCORDER

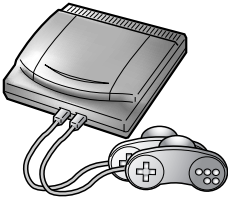

TV GAME



VCR

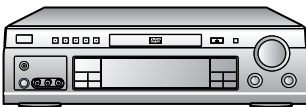

DVD

Yellow : To video input terminal
 White : To audio input (L) terminal
 Red : To audio input (R) terminal

(Front connection terminals of TV)

Pull open the front door

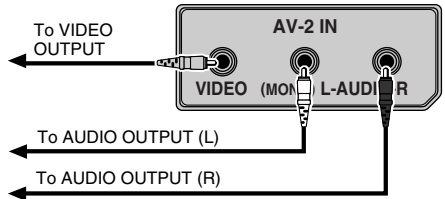

(Rear connection terminals of TV)

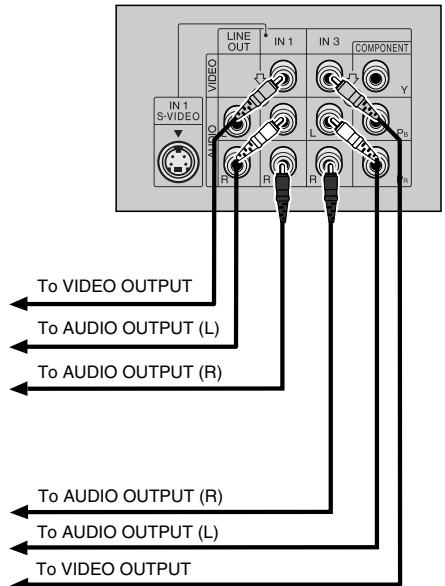

Using the Video and Audio Input Terminals (Continued)

Notes:

- COMPONENT terminals are DVD compatible, allows you to enjoy the highest quality playback image than the image from IN 1 S-VIDEO terminal.
- The IN 1 S-VIDEO terminal is used to obtain a higher quality image by importing image signals.
- The S-VIDEO terminal is for the video image only. To receive an audio signal, connect the audio cable to the IN 1 AUDIO terminals (left and right).

(Rear connection terminals of TV)

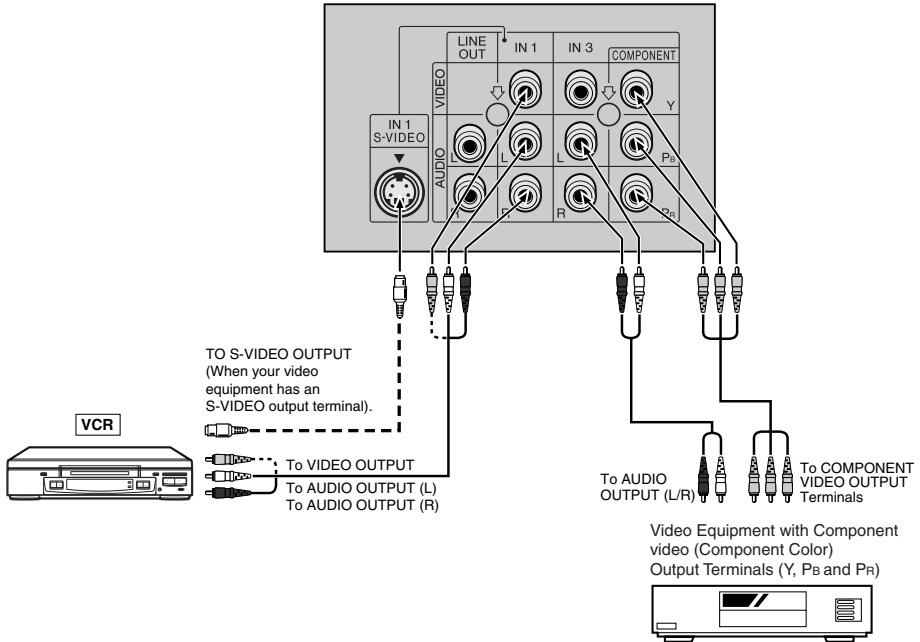

• To watch video material playback

- Press the Remote's **INPUT** button to select the VIDEO INPUT mode for the video equipment you wish to play.
- The external VIDEO INPUT mode will change as follows each time the **INPUT** button is pressed.

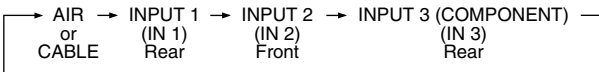

- When the AV cables are connected to the VIDEO INPUT 3 and COMPONENT Y, Pb and Pr terminals simultaneously, the COMPONENT terminal has priority over the VIDEO terminal.
- INPUT mode can be selected by pressing either the **CH ▲** on the TV remote control when the TV is set to the highest channel stored in memory, or by pressing the **CH ▼** when it is set to the lowest channel.

Note:

- When connecting video or audio equipment to the television, be sure that the power is turned off in order to prevent damage to either the television or the equipment being connected.
- The S-Video terminal has priority over the VIDEO terminal (IN 1). When you wish to use video equipment connected to the VIDEO terminal (IN 1), unplug equipment connected to the S-VIDEO terminal.
- For detailed information on the connection and use of auxiliary equipment, refer to the instruction manuals of the equipment being used.
- The connection cables/cords can be obtained from your local video store.

Using the Audio Output Terminals

- These terminals are used for connecting an external audio amplifier. The STEREO/MONO/SAP, VOLUME, MUTE and FAO functions can all be controlled via the television's remote control or directly on the TV itself. These terminals relay the audio signal of all programs being displayed on the TV screen.

(AUDIO OUTPUT terminals are located on the rear of the cabinet.)

CONNECTIONS

(Rear connection terminals of TV)

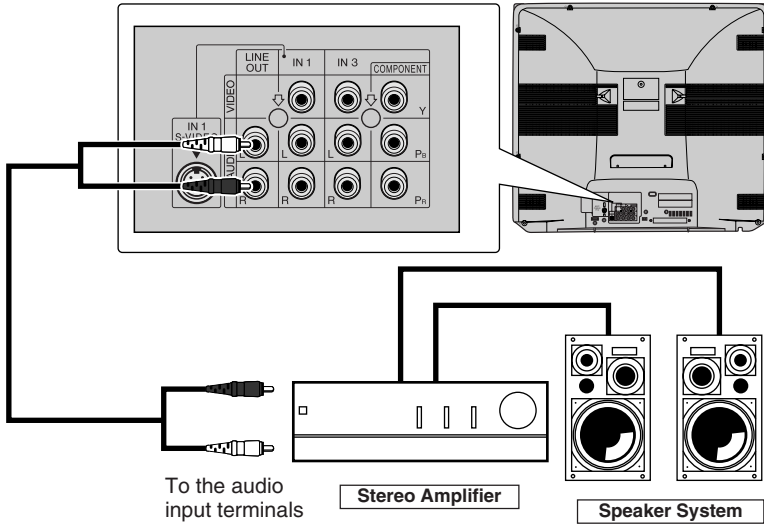

- (1) Before connecting the cables, turn on the TV and adjust the TV volume for a moderate listening level.
- (2) Turn off the TV and connect the audio cables to the AUDIO LINE OUTPUT terminals on the TV.
- (3) Turn the TV set and stereo amplifier on.
- (4) If you desire, you can turn off the sound of the TV's internal speakers by accessing the TV's AUDIO SELECT screen. See pages 12, 13.
- (5) Adjust the volume control on the stereo amplifier to a moderate listening level.
- (6) Control of the audio can be adjusted using the audio controls (STEREO/MONO/SAP, VOLUME, MUTE and FAO), from either the remote control, or directly from the TV set.

Note:

- For detailed information on the connection and use of auxiliary equipment, refer to the operation manuals of the equipment being used.
- When connecting monaural equipment to the AUDIO INPUT or OUTPUT of this set, use an audio connection cord and plug adaptor as shown below.
- When FAO is set to "OFF", we recommend you to keep the TV's audio output level high for optimal sound quality. (see page 12.)

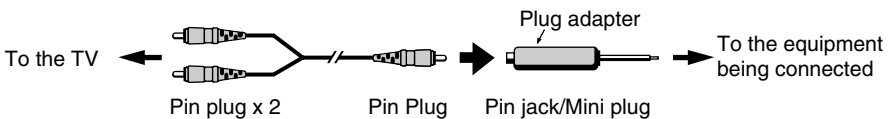

Operation of Universal Remote Control

● Universal Remote Control

With the purchase of your television set you also have received the latest innovation in remote control technology. With its easy-to-use push button keyboard, your Remote can control your television set and most infrared remote controlled VCRs, cable TV converters and DVDs as well.

Note:

- Depending on the model year produced, brand and type of VCR, cable TV converter and DVD, some models may not be compatible with the remote control.
- Some brands may not enable channel selection until the **ENTER** is pressed. In such case, try the following.

Example:

When you select channel 24,
(1) Press **REMOTE KEYPAD** "2".
(2) Press **REMOTE KEYPAD** "4".
(3) Press **ENTER**.

For detailed information on the use of the Cable TV converter Box refer to their operating manuals.

● Using your Remote with your TV

After installing the batteries, set the **CATV/ DVD-TV/VCR** on the Remote to the TV position. (If you can change the channel of the TV by pressing **CH ▲/▼** on the Remote Control, it is in the TV position.)

● "Identifying" VCRs, cable TV converters and DVDs

Your Remote Control has been set at the factory to operate your TV and many remote controlled VCRs, cable TV converters and DVDs. However, in some cases an easy one-time set-up step may be necessary before the Remote will operate accessory VCRs, cable TV converters and DVDs.

- In this set-up step, the Remote locates and memorizes the remote control transmitter code for the VCR, cable TV converters and DVDs.
- Once "identified", the Remote sends proper signals to operate your accessory.
- This identifying step will not have to be repeated until power to the Remote is interrupted due to a battery failure.

● Using your remote control with a VCR

Once you make certain the Remote Control has "identified" your remote controlled VCR or DVD, the Remote is ready to operate your unit. The various VCR or DVD function buttons on the Remote will not operate your VCR or DVD if those features are not already found on your unit.

- All VCR buttons will operate whether the Remote is in TV or VCR modes.
- For detailed information on the use of the VCR or DVD, refer to the operation manual of the VCR or DVD.

DVD/VCR POWER

Press to turn the VCR or DVD on and off.

PLAY ▶

Press to playback a tape or disc.

REWIND ◀◀

Press to rewind a tape or reverse a disc. For some VCRs or DVDs you may need to press **STOP** first, then **REWIND**.

PAUSE II

Press to temporarily stop the tape or disc during playback or recording (VCR only). Press again to release **PAUSE**.

STOP ■

Press to stop the tape or disc.

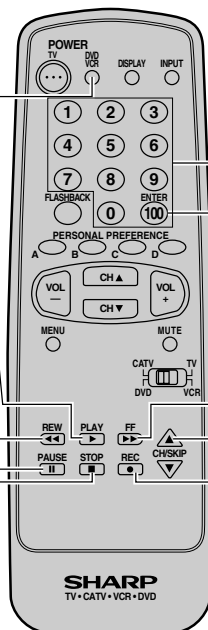

REMOTE KEYPAD

Use to enter two-digit code numbers when identifying your VCR, DVD and CATV converter.

ENTER

FF ▶▶

Press to rapidly advance the tape or disc. For some VCRs or DVDs, you may need to press **STOP** first, then **FF**.

VCR CHANNEL UP (▲)/ DOWN (▼)

Press to scan up or down through channels on the VCR.

DVD SKIP

Press to jump forward to the beginning of the next chapter/track, or backward to the beginning of the current chapter/track, and automatically start to play that chapter/track.

RECORD ●

Press to begin recording. (VCR only)

Operation of Universal Remote Control (Continued)

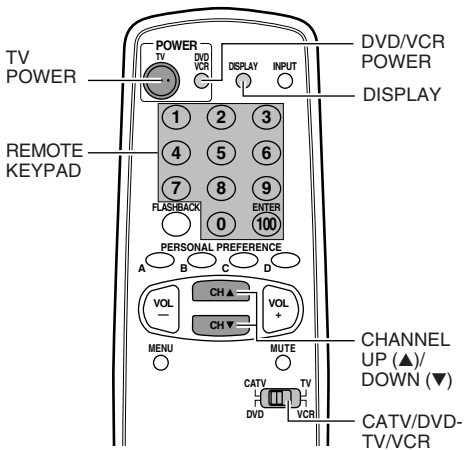

● How to identify a VCR

The remote control may already be set to operate your VCR. Try this initial check before going on to the following "identifying" section.

- (1) Slide **CATV/DVD-TV/VCR** switch to VCR.
- (2) Point the Remote towards VCR and press **POWER (DVD/VCR)**.
- (3) Does the Remote turn the VCR ON and OFF?
 - If yes, the Remote is ready to operate the VCR and no further steps are needed.
 - If no, continue to the "identifying" section.

Setting Method

Refer to the following steps and list to quickly find the remote control code for your accessory VCR.

- First look up your VCR's remote control code number before going through the Setting Method.
- (1) Slide **CATV/DVD-TV/VCR** switch to VCR.
 - (2) Press and hold down **DISPLAY** and **CH ▼** on your remote control. Then release both buttons.
 - (3) Within 10 seconds after releasing **DISPLAY** and **CH ▼**, enter your VCR's two-digit remote control code number using the **REMOTE KEYPAD** (refer to the list).
 - The remote control is now ready to send commands to your VCR.

Some brands have more than one remote code listed, due to changes in the remote codes from early to later model years, or due to format differences (VHS/BETA). In such cases, you may have to try more than one code to find the code your VCR accepts.

VCR BRAND	REMOTE CONTROL CODE NUMBER
Akai	25, 26, 37
Audio Dynamics	15, 22, 30
Broksonic	32
Canon	04
Capehart	34
Craig	10, 31
Curtis Mathis	04
Daewoo	34
DBX	15, 22, 30
Dynatech	29
Emerson	21, 32, 35
Fisher	09, 10, 11
Funai	28, 29
GE	04
Goldstar	24
Hitachi	06
Instant Replay	04
JC Penney	04, 06, 24, 30
JVC	15, 41, 42
Kenwood	14, 15
Lloyds	29
Magnavox	04, 05, 08
Magnin	31
Marantz	30
Memorex	04, 10, 24, 29
Minolta	06
Mitsubishi	17, 18, 39, 40
Montgomery Ward	02, 43
Multitech	29
NEC	15, 22, 30
Panasonic	04, 44, 45
Pentax	05, 06
Philco	04, 05
Philips	04, 05, 08
Quasar	04
RCA	06, 07, 33
Realistic	01, 02, 10, 24
Samsung	23, 31
Sanyo	14, 10
Scott	20
Sears	06, 11, 24
Sharp	01, 02, 03
Shintom	36
Sony	12, 13, 38
Sound Design	29
Sylvania	04, 05, 08
Symphonic	29
Tatung	15
Teac	15, 29
Teknika	27, 29
Thomas	29
TMK	21
Toshiba	19, 20
Video Concepts	30
Yamaha	15, 29, 30
Zenith	16

Note: ▶

Depending on the model, year produced, brand, and type of VCR, some models may not be compatible with the remote control.

Operation of Universal Remote Control (Continued)

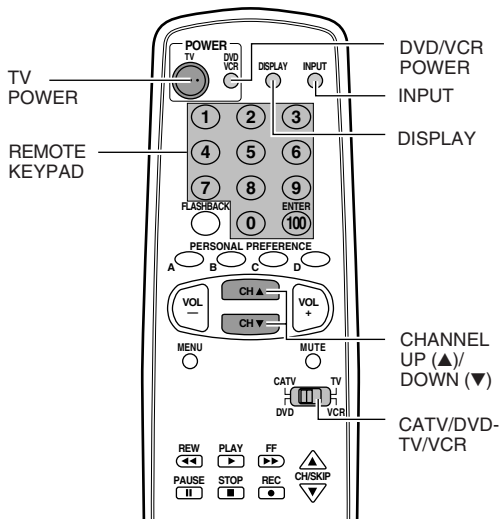

• How to identify a DVD

The remote control may already be set to operate your DVD. Try this initial check before going on to the following "identifying" section.

- (1) Slide **CATV/DVD-TV/VCR** switch to DVD.
- (2) Point Remote towards DVD and press **DVD/VCR POWER**.
- (3) Does the Remote turn the DVD ON and OFF?
 - If yes, the Remote is ready to operate the DVD and no further steps are needed.
 - If no, continue to the "identifying" section.

Setting Method.

Refer to the following steps and list to quickly find the remote control code for your accessory DVD.

- First look up your DVD's remote control code number before going through the Setting Method.
- (1) Slide **CATV/DVD-TV/VCR** switch to DVD.
 - (2) Press and hold down **INPUT** and **CH ▼** on your remote control. Then release both buttons.
 - (3) Within 10 seconds after releasing **INPUT** and **CH ▼**, enter your DVD's two-digit remote control code number using **REMOTE KEYPAD** (refer to the list).
 - The remote control is now ready to send commands to your DVD.

DVD BRAND	REMOTE CONTROL CODE NUMBER
Denon	02
JVC	09
Magnavox	04
Marantz	04
Mitsubishi	06
Panasonic	02
Philips	04
Pioneer	08
Proscan	03
RCA	03
Samsung	07
Sharp	01, 10
Sony	05
Toshiba	04
Yamaha	02
Zenith	04

Note:

Depending on the model, year produced, brand, and type of DVD, some models may not be compatible with the remote control.

Operation of Universal Remote Control (Continued)

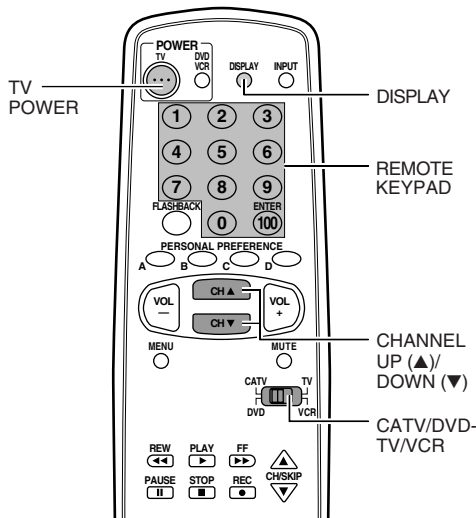

• How to identify a cable converter

Setting Method.

Refer to the following steps and list to quickly find the remote control code for your cable TV converter.

- First look up your converter's remote code number before going through the Setting Method below.
- (1) Slide **CATV /DVD-TV/VCR** switch to CATV.
 - (2) Press and hold down **DISPLAY** and **CH ▼** on your remote control. Then release both buttons.
 - (3) Within 10 seconds after releasing **DISPLAY** and **CH ▼**, enter your converter's two-digit code number using **REMOTE KEYPAD** (refer to the list).
- The remote control is now ready to send commands to your converter.
 - Some brands have more than one remote code listed due to changes in the remote codes from early to later model years. In such cases, you may have to try more than one code to find the code your converter accepts.

Note: ➤

Depending on the model, year produced, brand, and type of CATV converter, some models may not be compatible with the remote control.

CATV CONVERTER BRAND	REMOTE CONTROL CODE NUMBER
Anvision	07, 08
Cable Star	07, 08
Eagle	08
General Instrument	04, 05, 15, 23, 24, 25, 30, 36
Jerrold	04, 05, 15, 23, 24, 25, 30, 36
Magnavox	07, 08, 19, 25, 28, 29, 32, 33, 40, 41
Oak Sigma	18
Panasonic	27, 39
Philips	07, 08, 19, 26, 28, 29, 32, 33, 40, 41
Pioneer	18, 20
Randtek	07, 08
RCA	27, 43
Scientific Atlanta	03, 22, 42
Sony	44
Viewstar	07, 08, 19, 26, 28, 29, 32, 33, 40, 41
Zenith	14

Before Calling for Service

Check these items and see if you can correct the trouble with a slight adjustment of the controls.

QUICK SERVICE CHECK LIST	PROBLEM																		
POSSIBLE REMEDY	No Playback of VCR and Disc Player	No Picture or Sound from External Video/Audio Products	Remote Control Doesn't Work	Bars on Screen	Picture Distorted	Picture Rolls Vertically	No Color	Poor Reception on Some Channels	Weak Picture	Lines or Streaks in Picture	Ghosts in Picture	Picture Blurred	Sound OK, Picture Poor	Picture OK, Sound Poor	No Picture or Sound	Dark and Blank Picture	External Electrical Noise Interfering with TV's Operation	Color on Part of the Screen Appears Distorted	
Try a new channel, if OK, then there is a possible station trouble.					X	X	X	X	X	X	X	X	X	X	X				
Is TV plugged in? Power at outlet?	X	X													X				
Is TV's POWER button on?	X														X				
Is antenna connected to terminal on the back of the set?							X	X	X		X	X	X	X					
If outside antenna is being used, check for broken wire.				X	X	X	X	X	X	X	X	X	X	X					
Check for local interference or external electrical noise.				X	X		X		X	X		X	X				X		
Turn off the POWER and then turn it on after about a minute.		X													X				
Adjust COLOR control.							X												
Adjust PICTURE control.								X					X						
Check external Video/Audio products: look for loose/broken connection leads. (Refer to pages 38–40)	X	X											X	X	X				
Check batteries of Remote Control.			X																
Slide CATV/DVD-TV/VCR Select Switch to TV position.			X																
Are audio cables connected firmly? Check the volume level.															X				
Is SPEAKER ON? See pages 12, 13.															X				
Change Closed Caption mode to "OFF"/Energy Save mode to "OFF".																X			
Unplug the TV and plug it in again after 2 minutes or longer.			X			X	X	X	X				X	X	X	X	X	X	X

Note:

- If no TEXT broadcast is being received while viewing in the TEXT mode, the screen may become dark and blank for some programs. Should this occur, switch the Closed Caption mode to "OFF".



(Dark and Blank Picture)

Calling for Service

For location of the nearest Sharp Authorized Servicer, or to obtain product literature accessories, supplies, or customer assistance, please call 1-800-BE-SHARP.

Specifications

MODEL	27F540	32F540
Receiving System	NTSC	
Stereo Broadcast	MTS/SAP	
Reception Channels		
AIR	VHF	2-13 ch
	UHF	14-69 ch
CATV	1-125 ch	
Channel Tuning	181-channel Reception PLL tuning system	
Antenna Input Impedance	VHF/UHF 75 ohm Unbalanced	
Screen Size	27" Diagonally Measured	32" Diagonally Measured
Terminals	Audio/Video input x 3 (Front x 1, Rear x 2) S-Video input x 1 (Rear) COMPONENT x 1 (Rear) Audio output x 1 (Rear) Antenna x 1 (Rear)	
Sound Output	5 W (RMS) x 2	
Power Source	AC 120 V, 60 Hz	
Power Consumption	130 W	150 W
Dimensions [(W) x (H) x (D)] mm	25 ³ / ₄ " (W) x 23 ³⁹ / ₆₄ " (H) x 19 ⁵⁵ / ₆₄ " (D) [654 mm (W) x 599.5 mm (H) x 504 mm (D)]	29 ⁷ / ₈ " (W) x 26 ⁴⁹ / ₆₄ " (H) x 23 ³¹ / ₆₄ " (D) [759 mm (W) x 680 mm (H) x 596.5 mm (D)]
Weight (approx.)	94.8 lbs. (43 kg)	143 lbs. (65 kg)

- Design and specifications are subject to change without notice.

Lea estas instrucciones cuidadosamente y consérvelas a la mano para consultarlas en el futuro.

IMPORTANTE

Sírvase anotar el modelo del televisor y los números de serie en el espacio provisto, para ayudar a reportar en caso de pérdida o robo. Los números están ubicados en la parte posterior del televisor.

N° de modelo :
N° de serie :

INFORMACIÓN IMPORTANTE

Existen dos razones importantes para registrar dentro del plazo límite la garantía de su nuevo televisor SHARP, mediante la TARJETA DE REGISTRO incluida con el aparato.

PRIMERA – GARANTÍA

Garantiza al cliente la recepción inmediata de todas las prestaciones de consumidor en cuanto a piezas, servicio técnico y mano de obra aplicable a su adquisición.

SEGUNDA – ACTA DE SEGURIDAD DE PRODUCTOS DE CONSUMIDOR

Con el fin de garantizar al cliente la recepción puntual de cualquier notificación de seguridad sobre inspección, modificación o cancelación que se le pueda solicitar a SHARP bajo el Acta de seguridad de productos de consumidor de 1972. LEA CUIDADOSAMENTE LA CLÁUSULA “GARANTÍA LIMITADA” DE LA ÚLTIMA PÁGINA.

ADVERTENCIA : PARA REDUCIR EL RIESGO DE INCENDIO O DESCARGA ELÉCTRICA, NO EXPONGA ESTE APARATO A LA HUMEDAD.

	PRECAUCION RIESGO DE ELECTRO-CHOQUE NO ABRA	
<p>PRECAUCIÓN : PARA REDUCIR EL RIESGO DE DESCARGAS ELÉCTRICAS, NO RETIRE LA CUBIERTA (NI EL PANEL POSTERIOR). NO CONTIENE PIEZAS REPARABLES POR EL USUARIO. SOLICITE ASISTENCIA TÉCNICA A PERSONAL DE SERVICIO TÉCNICO ESPECIALIZADO.</p>		

 El relámpago con cabeza de flecha dentro de un triángulo trata de indicar al usuario que las partes dentro del producto representan riesgo de electrochoque para las personas.

 El signo de exclamación dentro de un triángulo trata de indicar al usuario que las instrucciones importantes de operación y servicio se encuentran en los documentos con el aparato.

“Nota para el instalador del sistema de TV por cable: Esta nota tiene el propósito de llamar la atención del instalador del sistema de cable acerca del Artículo 820-40 del Código Eléctrico Nacional, que contiene las directrices para la puesta a tierra y, en particular, especifica que el cable de puesta a tierra debe estar conectado al sistema de puesta a tierra del edificio lo más cerca a la entrada del cable.”

ADVERTENCIA - Las Normas de la FCC establecen que cualquier cambio o modificación no autorizada que se realice en este equipo y que no esté expresamente aprobado por el fabricante podría anular la autoridad del usuario para utilizar este equipo.

DESECHO DEL PRODUCTO
Este producto utiliza un Tubo de rayos catódicos (TRC) que contiene soldadura de estaño y plomo. El desecho de estos materiales deberá ser considerando regulaciones ambientales. Para obtener información sobre el desecho o el reciclado, póngase en contacto con las autoridades locales o con Electronics Industries Alliance: www.eiae.org

INFORMACIÓN IMPORTANTE (Continuación)

PRECAUCIÓN:

- No coloque el cable de alimentación de CA debajo del televisor u otro elemento pesado.
- Para impedir un incendio, no ponga nunca ningún tipo de vela o llama al descubierto encima o cerca del televisor.
- Para impedir un incendio o una descarga eléctrica, no exponga este aparato al goteo ni a las salpicaduras. Tampoco deberán ponerse encima de los productos objetos llenos de líquidos como, por ejemplo, floreros.

MEDIDAS DE SEGURIDAD IMPORTANTES

PRECAUCIÓN : Lea por favor todas estas instrucciones antes de poner en funcionamiento su televisor, y guárdelas para poder utilizarlas en el futuro.

La energía eléctrica permite realizar muchas funciones útiles. Este aparato ha sido diseñado y fabricado para garantizar su seguridad física. Sin embargo, UNA UTILIZACIÓN INAPROPIADA PODRÍA SER LA CAUSA DE DESCARGAS ELÉCTRICAS O INCENDIOS. Para mantener el buen funcionamiento de este equipo y evitar problemas, siga las normas básicas indicadas a continuación cuando lo instale, utilice o repare.

1. Desenchufe el televisor del tomacorriente antes de limpiarlo.
2. No utilice líquidos ni aerosoles de limpieza. Para limpiar el televisor utilice un paño húmedo.
3. No utilice accesorios que no los recomiende el fabricante del televisor porque podrían causar peligros.
4. No utilice el televisor cerca del agua – por ejemplo, cerca de una bañera, lavado, fregadero o lavadora, en un sótano húmedo, cerca de una piscina, etc.
5. No utilice este televisor sobre un carrito, un soporte o una mesa inestables. El televisor podría caerse causando serias heridas a niños o adultos, y, por supuesto, el aparato se estropearía. Ponga el televisor solamente sobre un carrito o soporte recomendado por el fabricante, o vendido junto con el televisor.
6. La combinación de carrito y televisor debe moverse con mucho cuidado. Las paradas rápidas, la fuerza excesiva y las superficies irregulares pueden ser la causa de que la combinación de televisor y carrito se volteen.
7. Cuando instale el televisor en una pared o en una estantería siga las instrucciones del fabricante, y utilice el kit de montaje aprobado por el fabricante.
8. Las ranuras y aberturas de la caja y del panel posterior o inferior sirven para la ventilación del aparato, para que éste funcione bien y para evitar que se caliente. Estas aberturas no deben taparse nunca. Este televisor no debe colocarse en un lugar cerrado (como un estante para libros) si éste no dispone de la ventilación apropiada.
9. Las aberturas no deben taparse nunca con un paño u otro material; y las aberturas del panel inferior no deben taparse tampoco colocando el televisor sobre una cama, sofá, alfombra u otra superficie similar. Este televisor no debe ponerse nunca cerca o encima de un radiador u otro aparato que produzca calor.
10. Este televisor sólo debe funcionar con la fuente de corriente indicada en la etiqueta del fabricante. Si no está seguro acerca del tipo de corriente de su hogar, póngase en contacto con el concesionario de quien adquirió el televisor o con la compañía eléctrica local.
En el caso de equipos de televisión diseñados para funcionar con baterías, consulte las instrucciones de uso.
11. Como medida de seguridad, el equipo de televisión está equipado con un enchufe polarizado de dos hilos. El enchufe polarizado de dos hilos solamente calza de una sola manera en el tomacorriente. Si el enchufe no entra en el tomacorriente, pídale a un electricista que le coloque un tomacorriente nuevo. No modifique el enchufe porque anulará esta característica de seguridad.
12. No permita que se apoye nada sobre el cable de alimentación. No ponga este televisor donde el cable pueda ser deformado por personas que caminen sobre él.



MEDIDAS DE SEGURIDAD IMPORTANTES (Continuación)

13. Cumpla con todos los avisos y las instrucciones marcados en el televisor.
14. Si se conecta una antena exterior al televisor, asegúrese de que el sistema de antena esté conectado a tierra para obtener cierta protección ante los aumentos de voltaje y la acumulación de cargas estáticas. La sección 810 del Código Eléctrico Nacional ofrece información relacionada con la conexión a tierra correcta del poste y la estructura de apoyo, la conexión a tierra del cable de entrada a una unidad de descarga, el tamaño de los conductores de conexión a tierra, la ubicación de la unidad de descarga de antena, la conexión a los electrodos de conexión a tierra, y los requisitos para el electrodo de conexión a tierra.

EJEMPLO DE CONEXIÓN A TIERRA DE LA ANTENA
SEGÚN EL CÓDIGO ELÉCTRICO NACIONAL

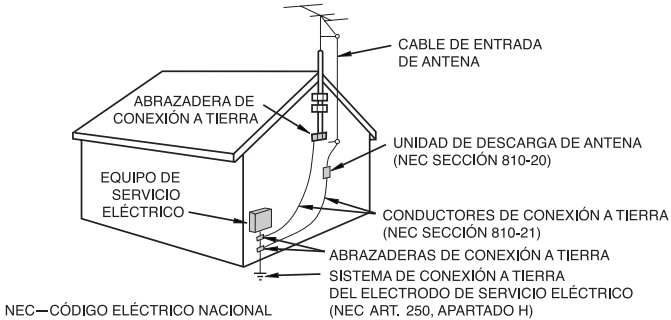

15. Para proteger aún más este televisor durante tormentas eléctricas o cuando se deje sin atender y sin utilizar durante largos periodos de tiempo, desenchufe el cable de alimentación del tomacorriente y desconecte la antena. Esto evitará que el aparato pueda estropearse debido a los relámpagos y la sobretensión en la línea de alimentación.
16. Un sistema de antena exterior no debe ubicarse cerca de líneas de alimentación elevadas, ni cerca de luces eléctricas o circuitos de alimentación. Tampoco debe ubicarse donde pueda caer sobre tales líneas o circuitos de alimentación. Cuando instale un sistema de antena exterior, tenga muchísimo cuidado para no tocar las líneas o circuitos de alimentación porque el contacto podría causar un accidente mortal.
17. No sobrecargue los tomacorrientes ni los cables de extensión porque esto podría causar un incendio o descarga eléctrica.
18. No meta nunca ningún objeto en el interior del televisor porque podría tocar piezas con alta tensión o causar un cortocircuito con otras piezas causando un incendio o descarga eléctrica. No derrame nunca ningún tipo de líquido sobre el televisor.
19. No trate de reparar el televisor usted mismo porque al abrir o quitar las tapas podría exponerse a una descarga de tensión u otros peligros. Las reparaciones debe realizarlas el personal de servicio CALIFICADO.
20. Desenchufe este televisor del tomacorriente y solicite el servicio de un técnico calificado cuando se produzcan las condiciones siguientes:
 - A. Cuando el cable de la alimentación o el enchufe estén estropeados.
 - B. Cuando haya derramado un líquido sobre el televisor.
 - C. Si el televisor ha quedado expuesto a la lluvia o al agua.
 - D. Si el televisor no funciona normalmente siguiendo las instrucciones de utilización. Ajuste solamente los controles indicados en las instrucciones de utilización. Un ajuste inadecuado de otros controles podría estropear el aparato y, entonces, sería necesario acudir a un técnico CALIFICADO para que éste lo repare y lo devuelva a su condición normal.
 - E. Si el televisor se ha caído o la caja se ha estropeado.
 - F. Cuando las prestaciones del televisor cambien considerablemente será necesario llamar al servicio de reparaciones.
21. Al finalizar cualquier servicio o reparación de este televisor, pida al técnico de servicio que realice comprobaciones de seguridad rutinarias para determinar si el televisor puede funcionar sin causar ningún problema.
22. Cuando sea necesario cambiar piezas, cerciórese de que el técnico de servicio utiliza las piezas de CAMBIO especificadas por el fabricante, aquellas que tengan las mismas características que las piezas originales. Las piezas de recambio no autorizadas pueden causar incendios, descargas eléctricas u otros peligros.

Referencia rápida de los controles de operación

● Nombres de los componentes

(ESPAÑOL)

Panel Delantero

ALIMENTACION (POWER)

Pulsando → Enciende (On).
Pulsando nuevamente → Apaga (Off).

SENSOR DE CONTROL
REMOTE

MENU (MENU)

Pulsando → Accede al MENU PRINCIPAL.
Pulsando nuevamente → Sale del MENU PRINCIPAL.

AUMENTO/DISMINUCION DEL VOLUMEN (VOL)

(+) Aumenta el sonido.
(-) Disminuye el sonido.

TERMINALES DE ENTRADA VIDEO/AUDIO IN 2 (POR DENTRO DE LA PUERTA)

CANAL SUPERIOR/INFERIOR

(▲) Selecciona el siguiente canal superior.
(▼) Selecciona el siguiente canal inferior.

Funciones Básicas Del Control Remoto

ALIMENTACION (POWER)

Pulsando → Enciende (On).
Pulsando nuevamente → Apaga (Off).

TECLADO A DISTANCIA (REMOTE KEYPAD)

Para tener acceso a cualquier canal empleando las teclas.

RETORNO AL CANAL ANTERIOR (FLASHBACK)

Para volver al canal anterior.

PREFERENCIAS PERSONALES

Con los botones Personal Preference puede programar sus programas favoritos utilizando las cuatro categorías A, B, C y D. Puede acceder a los canales rápidamente utilizando estos botones. (Consulte la página 32)

AUMENTO/DISMINUCION DEL VOLUMEN (VOLUME UP/DOWN)

(+) Aumenta el sonido.
(-) Disminuye el sonido.
• Cambia o selecciona los ajustes de TV en la visualización en pantalla.

PREPARACION (MENU)

Pulsando → Accede al MENU PRINCIPAL.
Pulsando nuevamente → Sale del MENU PRINCIPAL.

Botones CATV/DVD-TV/VCR MODE

En la posición TV/VCR. Las señales enviadas serán para el control del televisor y de la videograbadora.
En la posición CATV/DVD, las señales enviadas serán para el control del Receptor de TV por cable y de la Reproductor de DVD.

Ventanilla del transmisor de infrarrojos

VISUALIZACION (DISPLAY)

Pulsando → Aparece el canal de recepción por cuatro segundos.
Pulsando nuevamente → Elimina la visualización.

• En el modo de "Closed Caption" se muestra el canal de recepción por un corto tiempo.

ENTRADA (INPUT)

Pulsando → Cambia al modo de entrada 1 del video externo.
Pulsando 2 veces → Cambia al modo de entrada 2 del video externo.
Pulsando 3 veces → Cambia al modo de entrada 3 del video externo o al modo COMPONENT.
Pulsando 4 veces → Vuelve al modo TV original. Consulte la página 39.

INTRODUCIR (ENTER)

Se utiliza en algunos casos en los cuales una Caja de Inversor de Cable requiere una orden "enter" después de seleccionar los canales, al usar el teclado a distancia. (Consulte la página 41)

CANAL SUPERIOR/INFERIOR (CHANNEL UP/DOWN)

(▲) Selecciona el siguiente canal superior.
(▼) Selecciona el siguiente canal inferior.
• Consulte las páginas 28-30 para obtener información sobre el preajuste de canales.
• En el modo de MENU, mueve la marca "●".

SILENCIAMIENTO (MUTE)

Pulsando → Silencia el sonido.
Pulsando nuevamente → Restaura el sonido.
• Cuando se silencia el sonido, CLOSED CAPTION aparece si se encuentra disponible.

CONTROLES DEL DVD/VIDEO

Consulte la página 41.

Nota:

- Los botones que arriba pueden verse sombreados en el Control Remoto lucen en la oscuridad. Para usar el visor del control remoto que luce en la oscuridad, colocarlo bajo una luz fluorescente u otra fuente luminosa.
- El material fosforescente no contiene elementos radiactivos ni tóxicos, de modo que su uso no representa ningún peligro.
- El grado de iluminación variará de acuerdo con la potencia de la luz utilizada.
- El grado de iluminación irá decayendo con el tiempo y dependiendo de la temperatura.
- El tiempo necesario para cargar el visor fosforescente variará de acuerdo con la iluminación circundante.
- La luz del sol y la luz fluorescente son las más eficaces para la carga del visor.
- Las ilustraciones del televisor y del mando a distancia, y las indicaciones en pantalla, de este manual pueden diferir de su aspecto real.
- Las ilustraciones de esta página y de las siguientes son las del 32F540.

Antes de llamar al servicio de reparaciones

Verifique estos puntos para ver si usted mismo puede solucionar el problema.

<p style="text-align: center;">LISTA DE COMPROBACIONES DE SERVICIO RAPIDO</p>	<p style="text-align: center;">PROBLEMA</p>	<p>El vídeo o el reproductor de discos de vídeo no reproducen imágenes</p>	<p>El equipo de vídeo/audio externo no produce imágenes ni sonido</p>	<p>El mando a distancia no funciona</p>	<p>Barra en la pantalla</p>	<p>Imagen distorsionada</p>	<p>La imagen se desplaza verticalmente</p>	<p>No hay color</p>	<p>Mala recepción de algunos canales</p>	<p>Imagen débil</p>	<p>Franjas en la imagen</p>	<p>Imagen fantasma</p>	<p>Imagen borrosa</p>	<p>Sonido adecuado, imagen mala</p>	<p>Imagen adecuada, sonido malo</p>	<p>No hay imagen ni sonido</p>	<p>Imagen oscura y en blanco</p>	<p>Interferencia de ruido eléctrico externo con el funcionamiento del televisor</p>	<p>El color se ve distorsionado en parte de la pantalla</p>
<p style="text-align: center;">POSIBLE SOLUCIÓN</p>																			
<p>Pruebe con otro canal y si todo está bien, el problema puede ser de la emisora.</p>					X	X	X	X	X	X	X	X	X	X	X	X			
<p>Está conectado el televisor? Llega electricidad al tomacorrientes?</p>		X	X														X		
<p>Está conectado el interruptor del televisor?</p>		X															X		
<p>Está conectado la antena al terminal del panel posterior del televisor?</p>							X	X	X		X		X	X	X				
<p>Si utiliza una antena exterior, cerciórese de que el cable no esté dañado.</p>				X	X	X	X	X	X	X	X	X	X	X	X	X			
<p>Compruebe si hay interferencia local.</p>				X	X		X		X	X		X	X	X	X			X	
<p>Desconecte el interruptor POWER y vuelva a conectarlo después de transcurrir un minuto.</p>		X															X		
<p>Ajuste el control de COLOR.</p>							X												
<p>Ajuste el control de MATIZ.</p>									X					X					
<p>Verifique los productos externos de Vídeo/Audio, revise si hay fugas de conexiones sueltas o rotas.</p>	X	X												X	X	X			
<p>Compruebe el estado de las pilas del mando a distancia.</p>				X															
<p>Deslice CATV/DVD-TV/VCR selector para situarlo sobre la posición TV.</p>				X															
<p>Están bien conectados los cables de sonido? Compruebe el nivel del volumen.</p>																	X		
<p>Está conectado el altavoz?</p>																	X		
<p>Desactive (OFF) el modo CLOSED CAPTION / Desactive (OFF) el modo Ahorro de Energía (Energy Save).</p>										X								X	
<p>Desenchufe el televisor y vuelva a enchufarlo después de dos minutos o más.</p>		X			X	X	X	X						X	X	X	X	X	X

Nota: ➔

- Cuando se ve en modo TEXTO sin recibir emisiones de TEXTO, la pantalla puede ponerse en blanco y negro. Si ocurriera esto, ponga el modo CLOSED CAPTION en OFF.



(Imagen oscura y en blanco)

Solicitud de servicio técnico

Para la localización del Servicio Técnico Autorizado de Sharp más próximo o para conseguir material de información, repuestos o asistencia técnica, llame a 1-800-BE-SHARP.

Lisez attentivement ces instructions et gardez-les à proximité pour toute référence ultérieure.

IMPORTANT

Afin de vous aider en cas de perte ou de vol, inscrivez les numéros de série et de modèle du téléviseur dans les espaces fournis à cet effet. Ces numéros sont situés à l'arrière du téléviseur.

N° du modèle :

N° de série :

INFORMATIONS IMPORTANTES

Deux raisons importantes d'enregistrer rapidement la garantie de votre nouveau téléviseur SHARP à l'aide de la carte d'enregistrement (REGISTRATION CARD) incluse dans le colis :

LA PREMIERE – LA GARANTIE

Grâce à elle, vous obtiendrez immédiatement les avantages client concernant la garantie des pièces, du service et des travaux applicable à votre achat.

LA DEUXIEME – LA LOI SUR LA SECURITE DU PRODUIT DE CONSOMMATION (CONSUMER PRODUCT SAFETY ACT)

Grâce à elle, vous recevrez rapidement un avis de sécurité lors du contrôle, de la modification ou du rappel de votre produit que SHARP peut être amené à fournir conformément à la loi de 1972 sur la sécurité du produit de consommation. LISEZ ATTENTIVEMENT LE PARAGRAPHE «GARANTIE LIMITEE» DE LA DERNIERE PAGE.

AVERTISSEMENT: POUR REDUIRE LE RISQUE D'INCENDIE OU D'ELECTROCUTION, N'EXPOSEZ PAS CET EQUIPEMENT A DES ENDROITS TRES HUMIDES.



ATTENTION

**RISQUE D'ELECTROCUTION
NE PAS OUVRIR**



Le symbole de la foudre sous forme de flèche dans un triangle est supposé indiquer à l'utilisateur que les pièces internes au produit constituent un risque d'électrocution.



Le symbole du point d'exclamation dans un triangle est supposé indiquer à l'utilisateur que des instructions de fonctionnement et de maintenance importantes se trouvent dans la documentation fournie avec l'équipement.

**ATTENTION : POUR REDUIRE LE RISQUE
D'ELECTROCUTION,**

**NE RETIREZ PAS LE CAPOT (OU LE PANNEAU ARRIERE).
L'APPAREIL NE CONTIENT AUCUNE PIECE A ENTREtenir
PAR L'UTILISATEUR.**

**CONSULTEZ UN PERSONNEL QUALIFIE POUR
LA MAINTENANCE.**

“Note à l'intention de l'installateur du système CATV : Ce rappel est fourni afin d'attirer l'attention de l'installateur de système CATV sur l'article 820-40 du National Electrical Code qui indique les règles de mise à la terre appropriée et, en particulier, spécifie que la ligne de terre doit être connectée au réseau commun de mise à la terre du bâtiment, au point le plus proche possible de la source.”

AVERTISSEMENT - Les réglementations FCC établissent que des changements ou des modifications non autorisés sur cet équipement et non approuvés expressément par le fabricant peuvent annuler tout pouvoir de l'utilisateur sur le fonctionnement de cet équipement.

MISE AU REBUT DU PRODUIT

Ce produit utilise un tube à rayons cathodiques (TRC) contenant du plomb à braser et du brasage tendre. La mise au rebut de ces matières peut être réglementée pour des raisons environnementales. Pour toute information sur la mise au rebut ou le recyclage, contactez les autorités locales ou les précautions importantes préconisées par la société Electronics Industries Alliance sur : www.eiae.org.

INFORMATIONS IMPORTANTES (Suite)

ATTENTION:

- Ne placez pas le cordon d'alimentation sous le téléviseur ou sous tout autre objet lourd.
- Ne placez pas de bougies ni de flammes nues sur le téléviseur ou à sa proximité, afin d'éviter les incendies.
- Veillez à ne pas éclabousser ni faire tomber de l'eau sur ces appareils afin d'éviter les incendies ou les électrocutions. Ne placez jamais d'objets remplis de liquide, comme des vases, sur ces appareils.

PRÉCAUTIONS IMPORTANTES

ATTENTION : Veuillez lire toutes ces instructions avant d'utiliser votre télévision et conservez-les pour un usage ultérieur.

L'énergie électrique peut exécuter de nombreuses fonctions utiles. Cet appareil a été conçu et fabriqué de façon à garantir votre entière sécurité. CÉPENDANT, TOUTE UTILISATION INADEQUATE PEUT ENTRAINER DES RISQUES D'ELECTROCUTION OU D'INCENDIE. Afin de ne pas détruire les protections intégrées à cet appareil, respectez les règles de base suivantes pour son installation, son utilisation et sa maintenance.

1. Débranchez la télévision avant de la nettoyer.
2. N'utilisez pas de nettoyeurs liquides ou d'aérosols et utilisez un chiffon humide.
3. N'utilisez pas d'accessoires déconseillés par le fabricant de matériel vidéo, car ils impliquent des risques.
4. N'utilisez pas cette télévision à proximité d'eau — par exemple, près d'une baignoire, d'un lavabo, d'un évier ou d'un bac à laver, dans une cave humide ou près d'une piscine, etc.
5. Ne placez pas cet équipement sur un chariot, un support ou une table instable. La télévision peut tomber et provoquer de graves lésions à toute personne et causer de sérieux dommages à l'équipement. Utilisez uniquement un support ou un chariot recommandé par le fabricant ou vendu avec la télévision.
6. L'ensemble télévision-chariot doit être déplacé délicatement. Les arrêts brusques, une force excessive et des surfaces inégales peuvent renverser l'ensemble.
7. L'installation au mur ou sur une tablette doit être réalisée conformément aux instructions du fabricant et à l'aide d'un kit de montage approuvé par ce dernier.
8. Les fentes et les ouvertures du châssis à l'arrière ou dans la partie inférieure sont prévus pour la ventilation. Pour garantir un fonctionnement fiable de la télévision et pour la protéger de toute surchauffe, ces ouvertures ne doivent être ni obturées, ni recouvertes. La télévision ne doit pas être placée dans un endroit encastré tel qu'une bibliothèque, sauf si une ventilation adéquate est prévue.
9. Les ouvertures ne doivent jamais être recouvertes par un chiffon ou autre et celles de la partie inférieure ne doivent jamais être obturées si vous placez la télévision sur un lit, un sofa, un tapis ou toute surface similaire. Cette télévision ne doit être placée ni à proximité d'un radiateur ou d'un registre de chaleur, ni dessus.
10. Cette télévision doit être alimentée uniquement par le type d'alimentation électrique indiqué sur l'étiquette. Si vous n'êtes pas sûr du type d'alimentation de votre domicile, consultez votre revendeur de télévision ou la compagnie d'électricité locale (EDF en France).
Pour la télévision conçue pour fonctionner sur batterie, reportez-vous au mode d'emploi.
11. Du point de vue de la sécurité, la télévision est équipée d'une fiche polarisée à 2 fils (une lame plus importante que l'autre). La fiche polarisée à 2 fils ne pénètre dans la prise électrique que dans un seul sens.
Si la fiche ne correspond pas à la prise, demandez à votre électricien de remplacer la prise, elle doit être obsolète. Ne modifiez pas la fiche et ne désactivez pas cette fonction de sécurité.
12. Ne posez rien sur le cordon d'alimentation. Ne placez pas la télévision dans un emplacement où le cordon d'alimentation est susceptible d'être endommagé par le passage répété de personnes.



PRÉCAUTIONS IMPORTANTES (Suite)

13. Respectez tous les avertissements et instructions mentionnés sur la télévision.
14. Si une antenne extérieure est raccordée à la télévision, veillez à ce que le système d'antenne soit relié à la terre de façon à fournir une protection vis-à-vis des poussées de tension et des charges électrostatiques accumulées. La section 810 du National Electrical Code fournit des informations relatives à une mise à la terre correcte de la potence et de la structure portante, à une mise à la terre du fil d'entrée à une unité de décharge d'antenne, aux dimensions des conducteurs de terre, à l'emplacement de l'unité de décharge d'antenne, au raccordement des prises de terre ainsi qu'à leurs exigences.

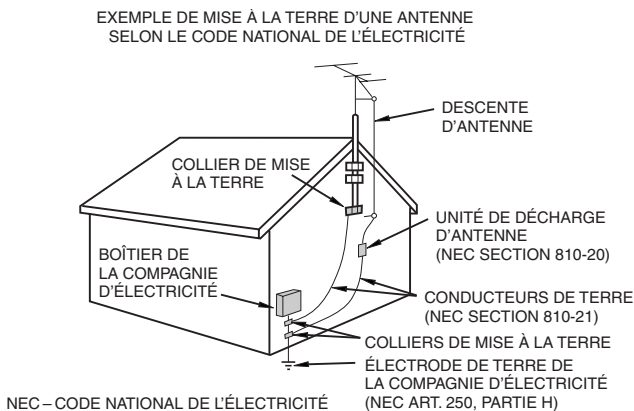

15. Pour tout ajout de protection à votre télévision en cas de foudre ou lorsque elle reste en veille et inutilisée pendant de longues périodes, débranchez-la et déconnectez l'antenne. Vous éviterez ainsi des dommages à votre équipement suite à la foudre et des poussées de tension.
16. Un système d'antenne extérieure ne doit pas être situé à proximité de lignes aériennes ou d'autres groupes électrogènes ou circuits électriques ou dans des emplacements où l'antenne pourrait tomber sur ce type de lignes ou circuits. Lors de l'installation d'un système d'antenne extérieure, faites extrêmement attention à ne pas entrer en contact avec ces lignes ou circuits, car cela pourrait vous être fatal.
17. Ne surchargez pas les prises et les prolongateurs de ligne afin d'éviter tout risque d'incendie ou d'électrocution.
18. N'introduisez jamais d'objets à travers les fentes du châssis, car ils pourraient entrer en contact avec des points de tension dangereux ou des pièces court-circuitées et provoquer ainsi un incendie ou une électrocution. Ne répandez jamais de liquides sur la télévision.
19. N'essayez pas de réparer vous-même votre télévision. L'ouverture ou le retrait des capots peut vous exposer à une tension dangereuse ou à d'autres risques. Confiez toutes les opérations de maintenance à un personnel qualifié.
20. Lorsque vous êtes confronté aux situations suivantes, débranchez la télévision et confiez toutes les opérations de maintenance à un personnel qualifié :
 - A. lorsque le cordon d'alimentation ou la fiche est endommagé ou effiloché ;
 - B. si du liquide a été répandu sur/dans la télévision ;
 - C. si la télévision a été exposée à la pluie ou à l'eau ;
 - D. si la télévision ne fonctionne pas normalement même en respectant le mode d'emploi. Réglez uniquement les commandes abordées par le mode d'emploi. Des réglages inappropriés d'autres commandes peuvent occasionner des dommages et nécessiteront ensuite, dans la plupart des cas, une intervention plus importante d'un technicien qualifié pour que la télévision fonctionne normalement ;
 - E. si la télévision a été renversée ou que le châssis est endommagé ;
 - F. lorsque la télévision présente une altération visible des performances — cela indique un besoin de maintenance.
21. Pour toute maintenance ou réparation de la télévision, demandez au technicien de réaliser des contrôles de sécurité classiques afin de déterminer si la télévision est en bon état de marche.
22. Lorsqu'un remplacement de pièces se révèle nécessaire, veillez à ce que le technicien utilise des pièces de rechange spécifiées par le fabricant et qu'elles aient les mêmes caractéristiques que la pièce d'origine. Des remplacements non autorisés peuvent occasionner un incendie, une électrocution ou d'autres risques.

Référence rapide sur les commandes

● Nomenclature

(FRANÇAIS)

Panneau Avant

ALIMENTATION (POWER)

Appuyer → Pour mettre sous tension.
Appuyer de nouveau → Pour mettre hors tension.

CAPTEUR DE
TÉLÉCOMMANDE

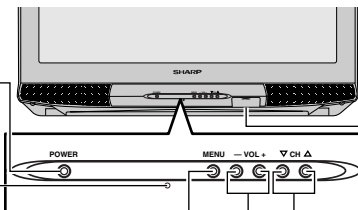

PRISES D'ENTRÉE
VIDÉO/AUDIO
(DERRIÈRE LE VOILET)

Canal HAUT/BAS

(▲) Sélectionne le canal supérieur suivant.
(▼) Sélectionne le canal inférieur précédent.

RÉGLAGE (MENU)

Appuyer → Pour mettre sous tension.
Appuyer de nouveau → Pour mettre hors tension.

AUGMENTATION/RÉDUCTION DU VOLUME SONORE (VOL)

(+) Pour augmenter le volume du son.
(-) Pour diminuer le volume du son.

Fonctions de base de la télécommande

ALIMENTATION (POWER)

Appuyer → Pour mettre sous tension.
Appuyer de nouveau → Pour mettre hors tension.

PAVE NUMÉRIQUE DE COMMANDE A DISTANCE (REMOTE KEYPAD)

Sélectionne directement le canal voulu sur le pavé numérique.

RETOUR (FLASHBACK)

Rappelle le canal regardé précédent.

PREFERENCES PERSONNELLES

Grâce aux touches de préférence personnelle, vous pouvez programmer vos programmes préférés à l'aide des 4 catégories: A, B, C et D. Ces touches vous permettent d'accéder rapidement à ces canaux. (Voir page 32)

AUGMENTATION/RÉDUCTION DU VOLUME SONORE (VOLUME UP/DOWN)

(+) Pour augmenter le volume du son.
(-) Pour diminuer le volume du son.
• Modifie ou sélectionne les réglages TV sur l'affichage sur écran.

RÉGLAGE (MENU)

Appuyer → Accès au MENU PRINCIPAL.
Appuyer de nouveau → Sortie du MENU PRINCIPAL.

SÉLECTEUR DE MODE

CATV/DVD-TV/VCR

En position TV/VCR, Les signaux envoyés sont destinés à commander le téléviseur et le magnétoscope.

En position CATV/DVD, les signaux envoyés sont destinés à commander le téléviseur et le magnétoscope.

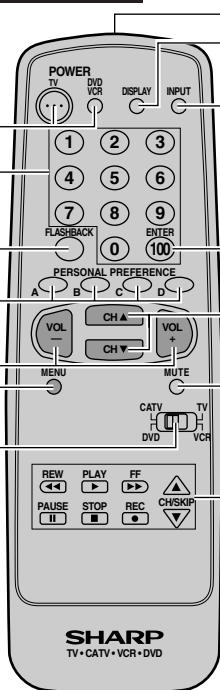

Fenêtre d'émission du signal infrarouge

AFFICHAGE (DISPLAY)

Appuyer → Pour afficher le canal reçu pendant quatre secondes.
Appuyer de nouveau → Pour faire disparaître le canal.
• Pour afficher temporairement le canal reçu en mode Sous-titres.

ENTRÉE (INPUT)

Appuyer → Pour sélectionner le mode ENTRÉE 1 vidéo externe.
Appuyer 2 fois → Pour sélectionner le mode ENTRÉE 2 vidéo externe.
Appuyer 3 fois → Pour sélectionner le mode ENTRÉE 3 vidéo externe ou le mode COMPOSANT.
Appuyer 4 fois → Pour revenir au mode TV initial. Voir page 39.

ENTRER (ENTER)

Parfois utilisée lorsqu'un convertisseur nécessite l'introduction d'une commande "enter" après la sélection de canaux à l'aide du pavé numérique de commande à distance. (Voir page 41)

TOUCHES DES CANAUX CROISSANT/ DÉCROISSANT (CHANNEL UP/DOWN)

(▲) Sélectionne le canal supérieur suivant.
(▼) Sélectionne le canal inférieur précédent.
• Voir pages 28-30 pour pré-régler les canaux.
• Déplace la curseur "●" sur l'écran du MENU.

SOURDINE (MUTE)

Appuyer → Mise en sourdine du son.
Appuyer de nouveau → Rétablissement du son.
• Lorsque le son est coupé, SOUS-TITRE apparaît si la fonction est disponible.

COMMANDE DU LECTEUR DE DVD/ MAGNÉTOSCOPE

Voir page 41.

Remarque:

- Les boutons ombrés de la télécommande illustrés ci-dessus brillent dans l'obscurité lorsque la télécommande a été placée sous une ampoule fluorescente ou toute autre source lumineuse.
- Le matériau phosphorescent n'est absolument pas toxique ou radioactif. Il peut donc être utilisé en toute sécurité.
- Le degré d'illumination variera en fonction de l'intensité de la source d'éclairage.
- Le degré d'illumination diminuera avec le temps, en fonction de la température.
- Le temps requis pour charger les touches phosphorescentes dépendra de l'éclairage environnant.
- Les rayons directs du soleil et les luminaires fluorescents constituent les meilleures sources de chargement des touches phosphorescentes.
- Les illustrations du téléviseur et de la télécommande ainsi que les affichages à l'écran dans ce mode d'emploi diffèrent de la réalité.
- Les illustrations du téléviseur sur cette page et les suivantes sont celles du 32F540.

Avant d'appeler un réparateur

Vérifier les points suivants afin de déterminer s'il est possible de remédier au problème par un simple réglage des commandes.

LISTE DES VÉRIFICATIONS POUR UN DÉPANNAGE RAPIDE	PROBLÈME																	
	Pas de reproduction d'un magnéto-scope ou lecteur de disque	Pas d'image ou de son d'un appareil vidéo/audio externe	La télécommande ne fonctionne pas	Barres sur l'écran	Distorsion de l'image	L'image défile verticalement	Pas de couleur	Faible réception de certains canaux	Image affaiblie	Lignes ou rayures dans l'image	Images fantômes	Image brouillée	Son normal, image médiocre	Image normale, son médiocre	Ni son, ni image	Image sombre et vide	Bruit électrique extérieur interférant avec le fonctionnement du téléviseur	La couleur sur une partie de l'écran semble altérée
SOLUTION POSSIBLE																		
Essayer un nouveau canal. S'il fonctionne, il s'agit probablement d'une panne de la chaîne.					X	X	X	X	X	X	X	X	X	X	X			
Le téléviseur est-il branché? La prise secteur fonctionne-t-elle?	X	X														X		
L'interrupteur POWER du téléviseur est-il sous tension?	X															X		
L'antenne est-elle raccordée aux bornes à l'arrière de l'appareil?							X	X	X		X		X		X			
Si l'antenne extérieure est utilisée, s'assurer qu'il n'y a pas de fils sectionnés.				X	X	X	X	X	X	X	X	X	X		X			
Vérifier s'il n'y a pas d'interférence locale ou de bruit électrique extérieur.				X	X	X		X	X	X	X		X	X			X	
Mettre l'interrupteur POWER hors tension puis de nouveau sous tension au bout d'une minute.	X														X			
Régler la commande de COULEUR.							X											
Régler la commande de CONTRASTE.									X					X				
Vérifier l'appareil vidéo/audio externe : s'assurer que les câbles de connexion ne sont pas desserrés ou cassés.	X	X											X	X	X			
Vérifier les piles de la télécommande.			X															
Faites glisser le sélecteur de mode CATV/DVD-TV/VCR sur la position TV.			X															
Les câbles audio sont-ils fermement connectés? Vérifier le niveau du volume.														X	X			
Les haut-parleurs fonctionnent-ils?															X			
Mettre le mode sous-titrage hors service "ARRÊT" Mode d'économie d'énergie sur "ARRÊT".																X		
Débrancher le téléviseur et le rebrancher après deux minutes.		X				X	X	X	X				X	X	X	X	X	X

Remarque:

- En mode TEXTE, s'il n'y a pas d'émission TEXTE à recevoir, l'écran du téléviseur pourrait être sombre et vide. Dans ce cas, placer le mode Sous-titrage hors service.



(Image sombre et vide)

Appel au service après-vente

Pour connaître l'emplacement du centre de service après-vente agréé Sharp le plus proche ou pour obtenir de la documentation sur les produits, des accessoires, des consommables ou une aide au consommateur, appelez le 1-800-BE-SHARP.

Limited Warranty

CONSUMER LIMITED WARRANTY

SHARP ELECTRONICS CORPORATION warrants to the first consumer purchaser that this Sharp brand product (the "Product"), when shipped in its original container, will be free from defective workmanship and materials, and agrees that it will, at its option, either repair the defect or replace the defective Product or part thereof with a new or remanufactured equivalent at no charge to the purchaser for parts or labor for the period(s) set forth below.

This warranty does not apply to any appearance items of the Product nor to the additional excluded item(s) set forth below nor to any Product the exterior of which has been damaged or defaced, which has been subjected to improper voltage or other misuse, abnormal service or handling, or which has been altered or modified in design or construction.

In order to enforce the rights under this limited warranty, the purchaser should follow the steps set forth below and provide proof of purchase to the servicer.

The limited warranty described herein is in addition to whatever implied warranties may be granted to purchasers by law. ALL IMPLIED WARRANTIES INCLUDING THE WARRANTIES OF MERCHANTABILITY AND FITNESS FOR USE ARE LIMITED TO THE PERIOD(S) FROM THE DATE OF PURCHASE SET FORTH BELOW. Some states do not allow limitations on how long an implied warranty lasts, so the above limitation may not apply to you.

Neither the sales personnel of the seller nor any other person is authorized to make any warranties other than those described herein, or to extend the duration of any warranties beyond the time period described herein on behalf of Sharp.

The warranties described herein shall be the sole and exclusive warranties granted by Sharp and shall be the sole and exclusive remedy available to the purchaser. Correction of defects, in the manner and for the period of time described herein, shall constitute complete fulfillment of all liabilities and responsibilities of Sharp to the purchaser with respect to the Product, and shall constitute full satisfaction of all claims, whether based on contract, negligence, strict liability or otherwise. In no event shall Sharp be liable or in any way responsible, for any damages or defects in the Product which were caused by repairs or attempted repairs performed by anyone other than an authorized servicer. Nor shall Sharp be liable or in any way responsible for any incidental or consequential economic or property damage. Some states do not allow the exclusion of incidental or consequential damages, so that above exclusion may not apply to you.

THIS WARRANTY GIVES YOU SPECIFIC LEGAL RIGHTS. YOU MAY ALSO HAVE OTHER RIGHTS WHICH VARY FROM STATE TO STATE.

Model Specific Section

Your Product Model Number & Description:

27F540, 27 inch Color Television

32F540, 32 inch Color Television

(Be sure to have this information available when you need service for your Product.)

Warranty Period for this Product:

One (1) year parts and labor. The warranty period continues for an additional one (1) year, for a total of two (2) years, with respect to the picture tube(s) in the Product for parts only. Labor and service are not provided free of charge for this additional period.

Additional Item(s) Excluded from Warranty Coverage (if any):

Non-rechargeable batteries.

Where to Obtain Service:

From a Sharp Authorized Servicer located in the United States. To find the location of the nearest Sharp Authorized Servicer, call Sharp toll free at 1-800-BE-SHARP.

What to Do to Obtain Service:

Contact your Sharp Authorized Servicer to obtain in-home service for this Product. The Servicer will come to your home and if it is necessary to remove the Product, the Servicer will reinstall it. Be sure to have **Proof of Purchase** available.

SHARP[®]
SHARP ELECTRONICS CORPORATION
Sharp Plaza, Mahwah, New Jersey 07430-2135