

SHARP • Roku TV

LC-43LB371U/LC-50LB371U
1080p, 60Hz, LED

Sharp Roku TV

USER GUIDE

Version 7.0
English

HD

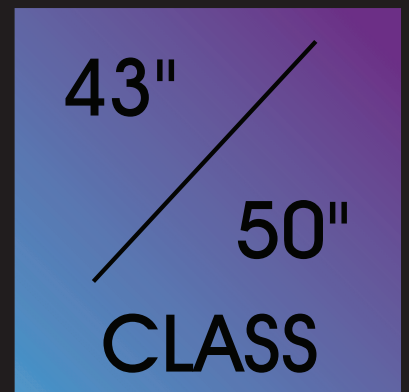

(42.6" Diagonal)

(49.7" Diagonal)

SHARP • Roku TV

Contents

CHILD SAFETY	1
Important Safety Instructions	2
WARNING	2
CAUTION	3
Welcome	4
The new standard in Smart TVs.....	4
Get the most out of your new TV	4
Installing the stand or wall-mount bracket	6
Installing the stand	6
Installing a wall-mount bracket	8
TV components	10
Package contents	10
Front features	10
Buttons	10
Side jacks	11
Back jacks	11
Remote control	12
What connection should I use?	14
Connecting a cable or satellite box	15
HDMI (best)	15
AV (composite video) (good).....	16
Coaxial (good).....	17
Connecting an antenna or cable TV (no box)	18
Connecting a DVD or Blu-ray player	19
HDMI (best)	19
AV (composite video) (good).....	20
Connecting a game console	21
HDMI (best)	21
AV (composite video) (good).....	22
Connecting a computer	23
Connecting a USB flash drive	24
Connecting headphones	25
Connecting external speakers or a sound bar	26
Digital audio using the SPDIF jack.....	26
Digital audio using the HDMI 1/ARC jack	27
Analog audio	28

Connecting a home theater system with multiple devices	29
Connecting power	30
Installing remote control batteries	31
Aiming the remote control.....	31
Guided Setup	32
Preparing for Internet connectivity.....	32
Starting Guided Setup	32
Setting up your TV.....	33
Other options:.....	34
Connected TV Home screen.....	38
Personalize your Home screen	38
Non-connected TV Home screen	39
Personalize your Home screen	39
Benefits of connecting	40
Connecting brings out your TV's full potential!.....	40
What is streaming?	40
But what if I didn't connect my TV?.....	41
Setting up Antenna TV	41
Why do I have to set up the TV tuner?	41
How do I set up the TV tuner?.....	42
Using your TV	45
Status light.....	45
Standby mode energy savings	45
Watching broadcast TV channels.....	45
Changing channels	45
Viewing program information.....	46
Adjusting settings	46
Switching TV inputs	46
Auto-detecting devices	46
Adjusting audio/video settings.....	46
Playing content from USB storage devices.....	47
Playing content from local network media servers	47
Using your TV in a hotel or dorm room	47
Adjusting TV settings	49
Settings menu.....	49
Options menu.....	50
Options menu settings.....	50
Advanced picture settings	51
Advanced picture settings menu options.....	51

Changing privacy settings	52
Resetting the advertising identifier.....	52
Limiting ad tracking	52
My Feed	53
Movies Coming Soon.....	53
Movies, TV shows, and people	53
Searching for something to watch	53
How do I search?	54
I found a show, now what?.....	54
Following on Roku.....	54
Recent Searches.....	54
Using the Roku Channel Store	55
Customizing your TV	56
Rearrange tiles	56
Edit broadcast TV channel lineup.....	57
Rename inputs	57
Remove unwanted tiles.....	57
Change themes	58
Change the screensaver	58
Change sound effects volume	58
Configure power settings.....	58
Power on settings	58
Auto power off settings.....	58
Configure parental controls.....	59
Creating a parental control PIN.....	59
Blocking Movie Store, TV Store, and News (US TV models only)	59
Blocking Broadcast TV shows	59
What happens when a TV show is blocked?.....	62
Changing the parental control PIN	62
Resetting parental controls	63
More settings	63
Changing network settings	63
Changing caption settings	64
Changing time settings	64
Scanning for broadcast TV channels again.....	65
Using your TV in a home theater	65
Turning off the speakers	65
Changing the audio mode	65
Setting up a digital audio connection	65
Controlling other devices through CEC.....	66

Restarting your TV	67
Resetting your TV.....	67
Reset audio/video settings	67
Factory reset everything	67
What if I can't access the Factory Reset option?	67
Changing your Roku Channel Store PIN preference	67
Getting system updates	68
Checking for updates on a connected TV	68
Getting updates on a non-connected TV	68
Other devices	69
Screen Mirroring your phone or tablet	69
Getting and using the Roku mobile app	69
Using a universal remote	69
Maintaining	69
Cleaning your TV cabinet	69
Cleaning your TV screen	69
Troubleshooting	70
FAQ.....	70
Video and audio.....	70
Remote control.....	73
General	74
Roku	75
Network.....	75
CEC-compatible devices	76
Specifications	78
Legal notices	79
One-year limited warranty - Sharp Televisions	83

CHILD SAFETY

PROPER TELEVISION PLACEMENT MATTERS



THE CONSUMER ELECTRONICS INDUSTRY CARES

- Manufacturers, retailers and the rest of the consumer electronics industry are committed to making home entertainment safe and enjoyable.
- As you enjoy your television, please note that all televisions - new and old- must be supported on proper stands or installed according to the manufacturer's recommendations. Televisions that are inappropriately situated on dressers, bookcases, shelves, desks, speakers, chests, carts, etc., may fall over, resulting in injury.

TUNE IN TO SAFETY

- **ALWAYS** follow the manufacturer's recommendations for the safe installation of your television.
- **ALWAYS** read and follow all instructions for proper use of your television.
- **NEVER** allow children to climb on or play on the television or the furniture on which the television is placed.
- **NEVER** place the television on furniture that can easily be used as steps, such as a chest of drawers.
- **ALWAYS** install the television where it cannot be pushed, pulled over or knocked down.
- **ALWAYS** route cords and cables connected to the television so that they cannot be tripped over, pulled or grabbed.

WALL OR CEILING MOUNT YOUR TELEVISION

- **ALWAYS** contact your retailer about professional installation if you have any doubts about your ability to safely mount your television.
- **ALWAYS** use a mount that has been recommended by the television manufacturer and has a safety certification by an independent laboratory (such as UL, CSA, ETL).
- **ALWAYS** follow all instructions supplied by the television and mount manufacturers.
- **ALWAYS** make sure that the wall or ceiling where you are mounting the television is appropriate. Some mounts are not designed to be mounted to walls and ceilings with steel studs or cinder block construction. If you are unsure, contact a professional installer.
- Televisions can be heavy. A minimum of two people is required for a wall or ceiling mount installation.

MOVING AN OLDER TELEVISION TO A NEW PLACE IN YOUR HOME

- Many new television buyers move their older CRT televisions into a secondary room after the purchase of a flat-panel television. Special care should be made in the placement of older CRT televisions.
- **ALWAYS** place your older CRT television on furniture that is sturdy and appropriate for its size and weight.
- **NEVER** place your older CRT television on a dresser where children may be tempted to use the drawers to climb.
- **ALWAYS** make sure your older CRT television does not hang over the edge of your furniture.



Important Safety Instructions



This symbol indicates that dangerous voltage constituting a risk of electric shock is present within your TV. This label is located on the back of your TV.



This symbol indicates that there are important operating and maintenance instructions in the literature accompanying your TV.



This symbol indicates that this product incorporates double insulation between the hazardous main voltage and user accessible parts. When servicing, use only identical replacement parts.

- 1 Read these instructions.
- 2 Keep these instructions.
- 3 Heed all warnings.
- 4 Follow all instructions.
- 5 Do not use this apparatus near water.
- 6 Clean only with dry cloth.
- 7 Do not block any ventilation openings. Install in accordance with the manufacturer's instructions.
- 8 Do not install near any heat sources such as radiators, heat registers, stoves, or other apparatus (including amplifiers) that produce heat.
- 9 Do not defeat the safety purpose of the polarized or grounding-type plug. A polarized plug has two blades with one wider than the other. A grounding type plug has two blades and a third grounding prong. The wide blade or the third prong are provided for your safety. If the provided plug does not fit into your outlet, consult an electrician for replacement of the obsolete outlet.
- 10 Protect the power cord from being walked on or pinched particularly at plugs, convenience receptacles, and the point where they exit from the apparatus.
- 11 Only use attachments/accessories specified by the manufacturer.
- 12 Use only with the cart, stand, tripod, bracket, or table specified by the manufacturer, or sold with the apparatus. When a cart is used, use caution when moving the cart/apparatus combination to avoid injury from tip-over.



S3125A

- 13 Unplug this apparatus during lightning storms or when unused for long periods of time.
- 14 Refer all servicing to qualified service personnel. Servicing is required when the apparatus has been damaged in any way, such as power-supply cord or plug is damaged, liquid has been spilled or objects have fallen into the apparatus, the apparatus has been exposed to rain or moisture, does not operate normally, or has been dropped.
- 15 The *wall plug* is the disconnecting device. The plug must remain readily operable.
- 16 Remote control batteries should not be exposed to excessive heat such as sunshine, fire, or the like.
- 17 The apparatus should not be exposed to dripping or splashing, and no objects filled with liquids, such as vases, should be placed on the apparatus.
- 18 Your TV has four VESA mounting holes on the back. If you attach a wall-mount bracket or TV stand to the back of your TV, **the bracket or stand must be securely attached using all four holes**. If you do not use all four mounting holes, your TV may fall and cause property damage or personal injury. See the documentation that came with your wall mount or TV stand for complete mounting instructions.

WARNING

Electric shock hazard

To reduce the risk of fire or electric shock, do not remove any cover or expose the device to rain or moisture. No user-serviceable parts are inside. Refer servicing to qualified service technicians.

Lightning

For added protection for your device receiver during a lightning storm, or when it is left unattended and unused for long periods of time, unplug it from the power outlet and disconnect any antenna or cable system. This helps prevent property damage and personal injury from lightning and power line surges.

Power lines

An outside antenna system should not be located in the vicinity of overhead power lines or other electric light or power circuits, or where it can fall into such power lines or circuits. When installing an outside antenna system, take extreme care to keep from touching such power lines or circuits as contact with them might be fatal.

Handling the LCD panel

- Your TV's screen is made of glass. Do not drop your TV or hit, jolt, or press hard against the LCD panel. If the screen breaks, be careful of broken glass.
- If the LCD panel is broken, make absolutely sure that you do not touch the liquid in the panel. This may cause skin inflammation.
- If the liquid gets in your mouth, immediately gargle, rinse, and consult with your doctor. Also, if the liquid gets in your eyes or touches your skin, consult with your doctor after rinsing for at least 15 minutes or longer in clean water.

Replacement parts

When replacement parts are required, make sure that the service technician uses replacement parts specified by the manufacturer that have the same characteristics as the original part. Unauthorized substitutions may result in fire, electric shock, personal injury, or other hazards.

Safety check

After completing any service or repair to this device, ask the service technician to perform routine safety checks to determine that your TV is in correct operating condition.

Power source

Operate your TV only from the type of power source indicated on the marking label. If you are not sure of the type of power supplied to your home, consult an electrician or your local power company.

Servicing

These servicing instructions are for use by qualified service personnel only. To reduce the risk of electric shock, do not perform any servicing other than that contained in the operating instructions unless you are qualified to do so.

CAUTION

Damage requiring service

Unplug this TV from the power outlet and refer servicing to qualified service personnel under the following conditions:

- When the power supply cord or plug is damaged or frayed.
- If liquid has been spilled or objects have fallen into your TV.
- If your TV has been exposed to rain or water.
- If your TV does not operate normally by following the operating instructions. Adjust only those controls covered by the operating instructions because incorrect adjustment of other controls may result in damage and will often require extensive work by a qualified technician to restore your TV to its normal operation.
- If your TV has been dropped or damaged in any way.
- When your TV exhibits a distinct change in performance.

Outdoor antenna grounding

If an outside antenna or cable system is connected to your TV, make sure that the antenna or cable system is grounded to provide some protection against voltage surges and built-up static charges. Article 810 of the National Electrical Code, ANSI/NFPA No. 70, provides information with respect to correct grounding of the mast and supporting structure, grounding of the lead-in wire to an antenna discharge unit, size of grounding conductors, location of the antenna-discharge unit, connection to grounding electrodes, and requirements for the grounding electrode.

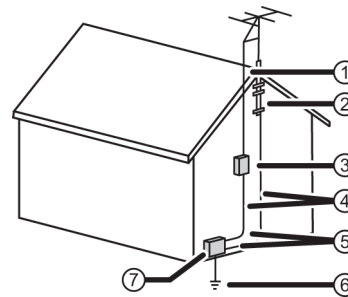

- 1 Antenna lead-in wire
- 2 Grounding clamp
- 3 Antenna discharge unit
- 4 Grounding conductors
- 5 Ground clamps
- 6 Power service grounding electrode system
- 7 Electric service equipment

Note to CATV system installer

Article 820 of the National Electrical Code, ANSI/NFPA No. 40 provides guidance for correct grounding. Specifically, it states that the cable ground must be connected to the grounding system of the building as close to the point of cable entry as practical.

Condensation

Moisture will form on the TV if the TV is brought from cool surroundings into a warm room or if the temperature of the room rises suddenly. When this happens, the TV's performance may be impaired. To prevent this, let the TV stand in its new surroundings for about an hour before switching it on, or make sure that the room temperature rises gradually.

Condensation may also form during the summer if the TV is exposed to the breeze from an air conditioner. In such cases, change the location of the TV.

Mobile telephone warning

To avoid interference with your TV picture and sound, operating problems, or even damage, keep your cordless and cellular telephones away from the TV.

End of life directives

Your TV may contain materials that are regulated for environmental reasons. Your TV also contains materials that can be recycled and reused. To help protect the environment, contact your local authorities for information about disposal or recycling and about finding a recycler in your area before you dispose of your TV.

Non-active pixels

The LCD panel contains almost 3 million thin film transistors, which provide exceptionally sharp video quality. Occasionally, a few non-active pixels may appear on the screen as a fixed blue, green, or red point. These non-active pixels do not adversely affect the performance of your TV, and are not considered defects.

43"/50" 1080p, 60Hz, LED Sharp Roku TV

Welcome

Congratulations on the purchase of your new TV! Discover the joy of endless entertainment. After it's set up, you'll be able to access a world of streaming content channels that may include Netflix, YouTube, Crackle, CNET and literally thousands more.

Important

Your TV receives automatic updates from time to time, enabling new content and features. This User Guide explains how to use your TV after it has been updated to version 7.0. If your TV has not yet been updated to version 7.0, some of the information in this User Guide does not apply. To determine the current version of your Roku TV, go to **Settings > System > About** after you complete Guided Setup.

The new standard in Smart TVs

Welcome to TV like you've most likely never seen before—a home screen that you can personalize with your favorite devices and streaming channels. Choose from hundreds of thousands of streaming movies and TV episodes, plus music, sports, kids, family, international and much more. You should never run out of things to watch.

Note

A paid subscription or other payments may be required for some channels. Channel availability is subject to change and varies by country. Not all content is available in countries or regions where Roku products are sold.

Get the most out of your new TV

Follow these simple steps to get the most out of your new TV.

1 Connect to the Internet

- It's simple, it's easy, and it will unlock a world of entertainment. All you need is a wireless network. There are hundreds of free streaming channels, subscriptions services like Netflix and Spotify, convenient ways to rent or buy a favorite film or show with Google Play and Cineplex and more.

2 Pick your favorite streaming channels

- Find the entertainment you love. From the latest blockbuster movies to your favorite TV shows, with tons of live sports, a broad selection of music streaming channels, popular programming in a dozen international languages, 24x7 live news and so much more, your new TV has your sweet spot. A paid subscription or other payments may be required for some channels.

3 Personalize your home screen

- Put your favorite broadcast TV, streaming channels, gaming console and other devices front-and-center on the home screen. No more flipping through inputs or wading through complicated menus. You can even personalize the names of each input and move tiles around so your most-often used devices and streaming channels are only a click away.

4 Search for your favorite movie, TV show, actor, or director

- Once you're connected to the internet, you can easily search across top streaming channels by movie or TV show title, actor or director—all from one place. Search results are organized by price so you can always see the best priced option. A paid subscription or other payments may be required for some channels.

5 Send your personal media to the big screen

- Send personal photos, videos, and music from your compatible smartphone or tablet to the TV screen in just a few taps. Plus, with Netflix and YouTube apps, send movies, shows, sport highlights, and more directly to your TV.

Note

The Roku app for Microsoft Windows devices does not cast videos.

6 Follow movies coming soon

- Use My Feed to choose from and follow a list of upcoming movies, and then watch for alerts each time one of your followed movies becomes available or changes price.

Note

My Feed is not available in the Roku App for Windows devices in the United States or Canada.

7 Take charge with a smartphone or tablet

- Control your TV with the included remote or from your compatible smartphone or a tablet with the free mobile app for iOS, Android, and Windows devices. Browse channels, view My Feed, and even search with voice via the free mobile app.

Note

Voice search and My Feed are not available in the Roku app for Windows devices.

- Mirror your compatible smartphone or tablet on your TV. Share videos, photos, web pages, and more from compatible devices.
- Use your compatible smartphone or tablet to connect your TV to the types of networks found in hotels and college dorms, where you may have to agree to terms, enter codes, or provide identifying information.

Note

Using your Roku TV on a restricted public network requires wireless availability and use of your network-connected smartphone, tablet, or computer to authenticate access to your account. Your TV must already be linked to your Roku account and activated. Also, you must use your Roku TV remote control, because the Remote feature of the Roku mobile app does not work on restricted public networks. Streaming content might be limited due to your geographic location or because of restrictions imposed by the wireless network host.

Many features work with top mobile devices. Please see <http://support.roku.com> for device compatibility information. Let's get started.

Installing the stand or wall-mount bracket

- If you want to place your TV on a table or in an entertainment center, go to [Installing the stand](#).
- If you want to mount your TV on a wall, go to [Installing a wall-mount bracket](#).

Notes

- If you plan to wall-mount your TV, do not install the stand.
- Store the stands and stand screws in case you decide to use the stand in the future.

Installing the stand

- 1 Carefully place your TV face-down on a cushioned, clean surface to protect the screen.

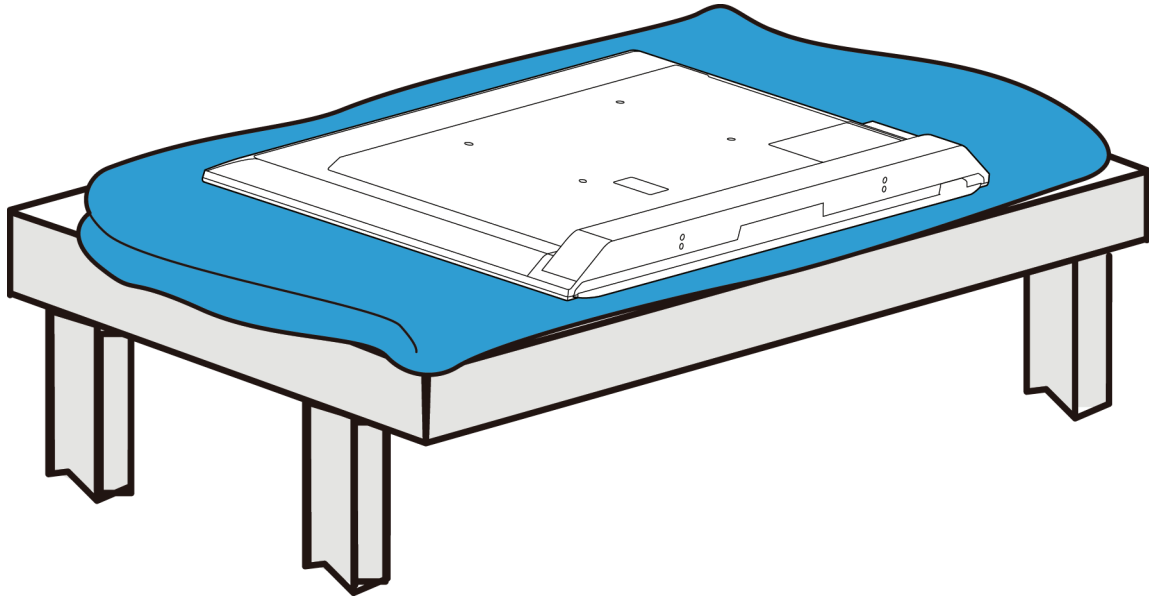

- 2 Align the TV stands with the screw holes on the bottom of the TV, then secure the stands to your TV with the four provided screws.

Model	Screw type	Screw length	# of screws
43-in.	M4	28 mm	4
50-in.	M6	36 mm	4

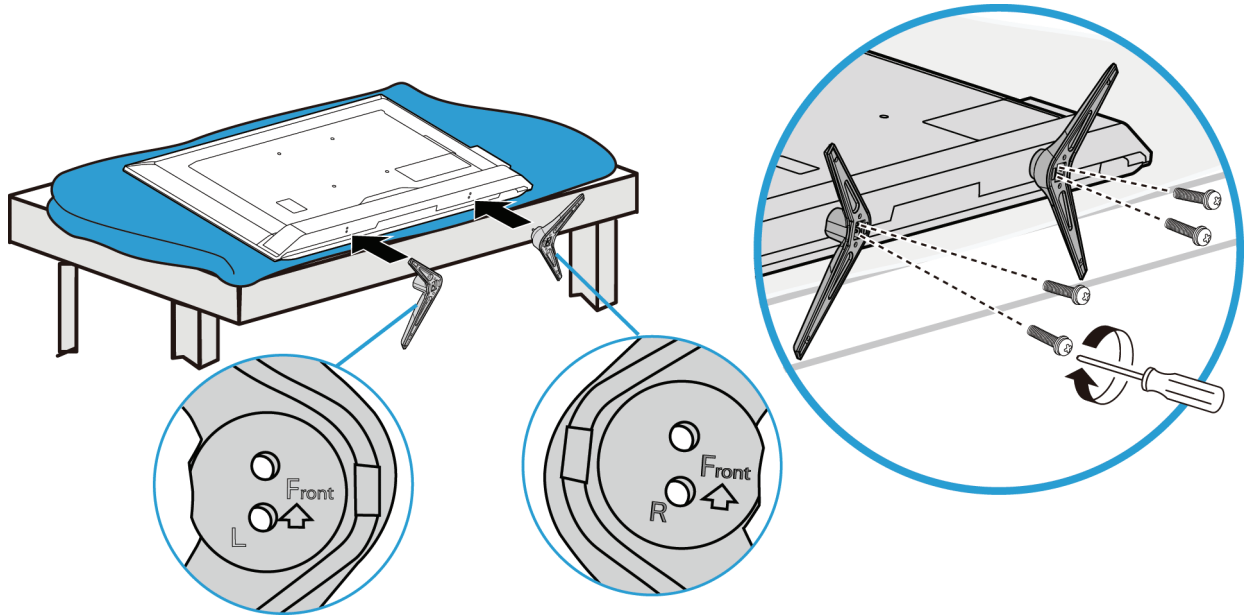

Installing a wall-mount bracket

Warnings

- Your TV has four VESA mounting holes on the back. If you attach a wall-mount bracket to the back of your TV, **the bracket must be securely attached, using all four holes.** If you do not use all four mounting holes, your TV may fall and cause property damage or personal injury. See the documentation that came with your wall mount for complete mounting instructions.
- Your TV is intended to be supported by a UL Listed wall mount bracket with suitable weight/load. (See [Miscellaneous](#) on page 79.)

- 1 Carefully place your TV face-down on a cushioned, clean surface to protect the screen.

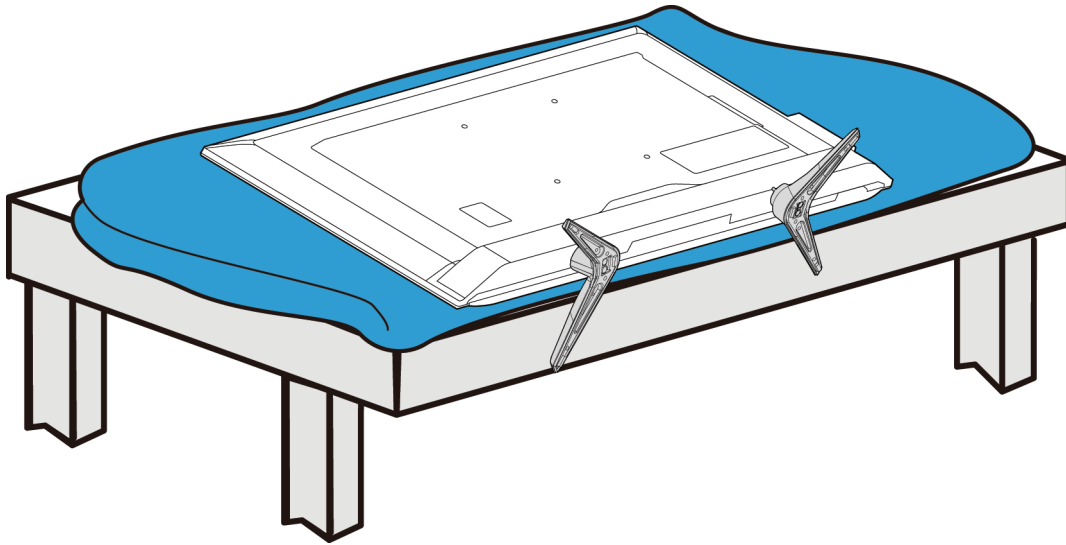

- 2 If the TV stands are installed, remove the four screws that secure the stands to your TV.

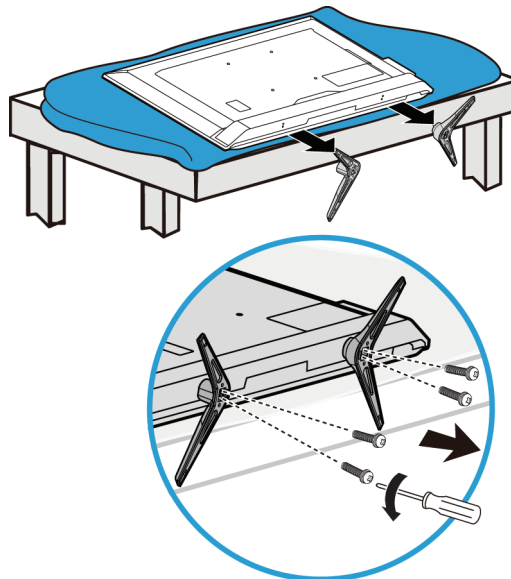

- 3 Remove the screws from the mounting holes on the back of your TV.
- 4 Attach the wall-mount bracket to your TV using the mounting holes on the back of your TV. See the instructions that came with the wall-mount bracket for information about how to correctly hang your TV.

Notes

- The length of the wall-mount screws vary depending on the wall-mount bracket you purchased. See the instructions that came with the wall-mount bracket for screw lengths.
- The mounting holes on the back of the your TV take type M6 screws.

43" model: 7.87 in. (200 mm)
50" model: 15.74 in. (400 mm)

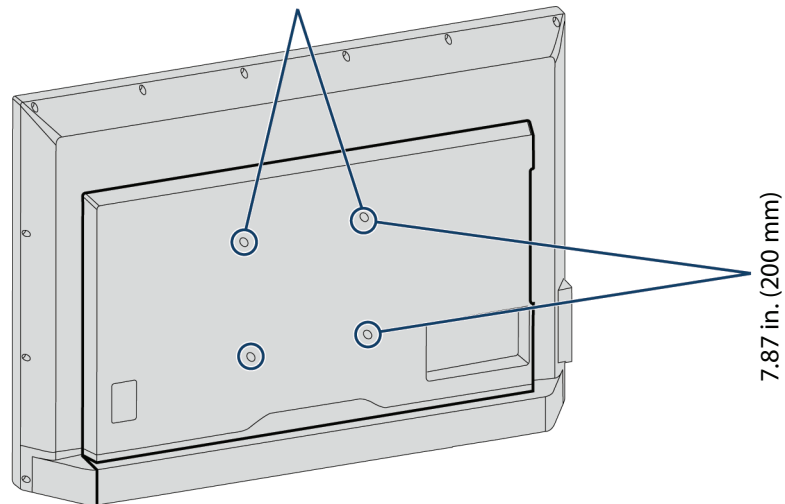

SHARP • Roku TV

TV components

LC-43LB371U/LC-50LB371U 43"/50" 1080p, 60Hz, LED Sharp Roku TV

Your TV has built-in controls for adjusting basic settings and several sets of jacks for connecting devices to your TV.

This section contains information about:

- [Package contents](#)
- [Front features](#)
- [Buttons](#)
- [Side jacks](#)
- [Back jacks](#)
- [Remote control](#)

Package contents

- 43" or 50" LED Sharp Roku TV
- Remote control and batteries (2 AAA)
- TV stands (2)
- Screws (4)
- Power cord
- [Quick Setup Guide](#)
- [Important Information](#)

Front features

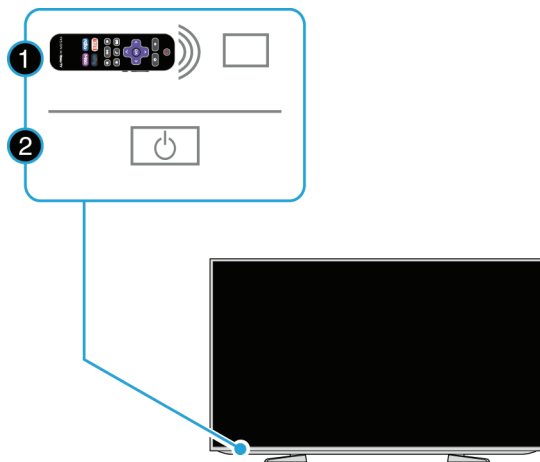

#	Item	Description
1	Remote control sensor	Receives signals from the remote control. Do not block.
2	Status indicator	See Status light on page 45.

Buttons

The controls on your TV enable you to perform simple functions, but are not a substitute for the remote control. Your TV has seven buttons on the right edge of the screen. From top to bottom, they perform the following functions:

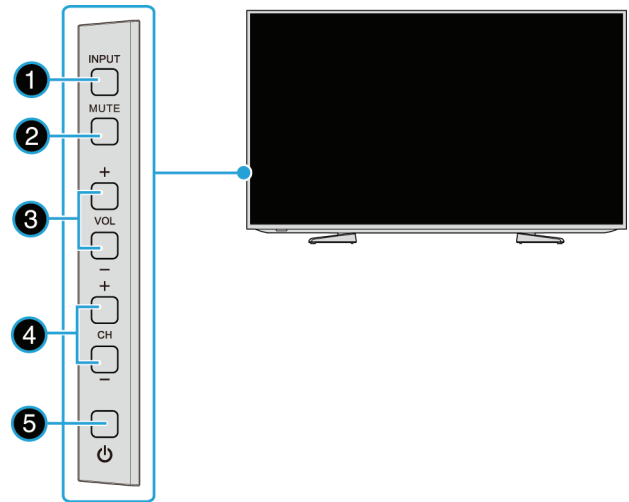

#	Item	Press to...
1	INPUT	Select among the configured TV inputs. Each press moves down one item. Also, while the Input panel is visible, the CH+ and CH- buttons move the highlight up and down. Pausing for a few moments selects the highlighted input.
2	MUTE	Mute or unmute the sound.
3	VOL+/VOL-	Press to increase or decrease the volume. OR Press to go to the next or previous menu in the on-screen menus.
4	CH+/CH-	Go to the next or previous channel in the channel list. For more information, see Watching broadcast TV channels on page 45. OR Move the highlighted item up down in the current menu.
5	⏻ (power)	Press to turn your TV on or off (standby mode). Warning: When your TV is off, power still flows through it. To completely disconnect power, unplug the power cord.

Side jacks

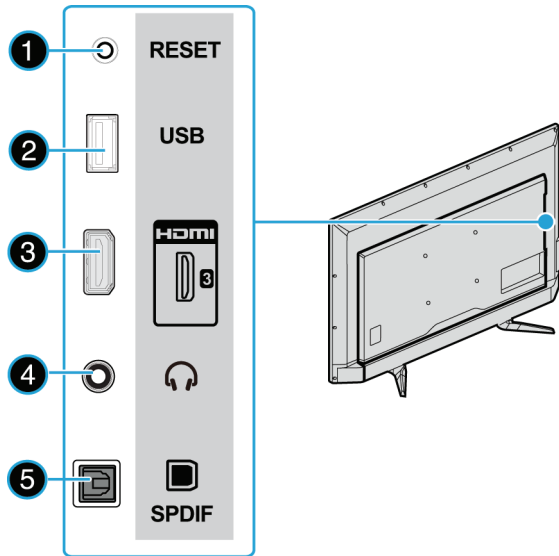

Back jacks

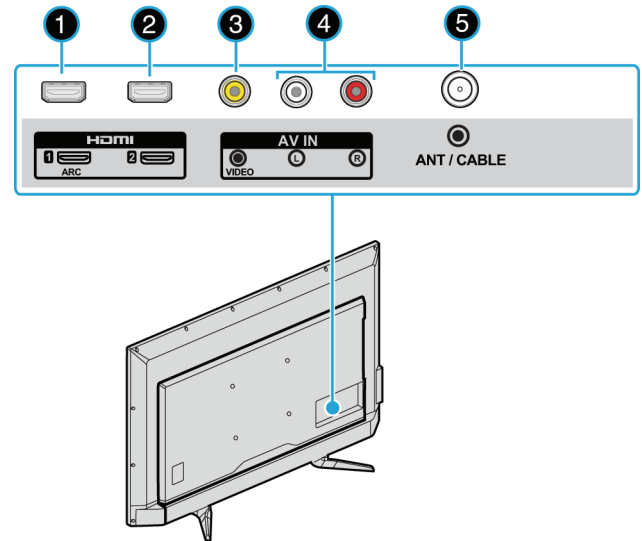

#	Item	Description
1	RESET	Press and hold reset for 15 seconds for factory reset. See What if I can't access the Factory Reset option? on page 67.
2	USB	Connect a USB flash drive to this jack to view compatible photos and video and listen to music files. For more information, see Connecting a USB flash drive on page 24 and Playing content from USB storage devices on page 47.
3	HDMI 3	Connect an HDMI device to this jack. For more information, see HDMI (best) on pages 15, 19, or 21 or Connecting a computer on page 23.
4	🎧	Connect headphones to this jack. See Connecting headphones on page 25. OR Connect an analog sound bar, speaker system, or home theater system to this jack to listen to TV audio through external speakers. For more information, see Analog audio on page 28.
5	SPDIF	Connect a digital sound bar, speaker system, or home theater system to this jack to listen to TV audio through external speakers. For more information, see Digital audio using the SPDIF jack on page 26.



#	Item	Description
1	HDMI1/ARC	Connect an HDMI device to this jack. For more information, see HDMI (best) on pages 15, 19, or 21 or Connecting a computer on page 23. OR Connect an ARC-enabled home theater receiver to this jack.
2	HDMI 2	Connect an HDMI device to this jack. For more information, see HDMI (best) on pages 15, 19, or 21 or Connecting a computer on page 23.
3	VIDEO	Connect the video for an AV device to the VIDEO jack. For more information, see AV (composite video) (good) on page 16, 20, or 22.
4	L and R (audio)	Connect the audio for an AV device to these jacks. For more information, see AV (composite video) (good) on page 16, 20, or 22.
5	ANT/CABLE IN	Connect an antenna or cable TV to this jack. For more information, see Coaxial (good) on page 17 or Connecting an antenna or cable TV (no box) on page 18.

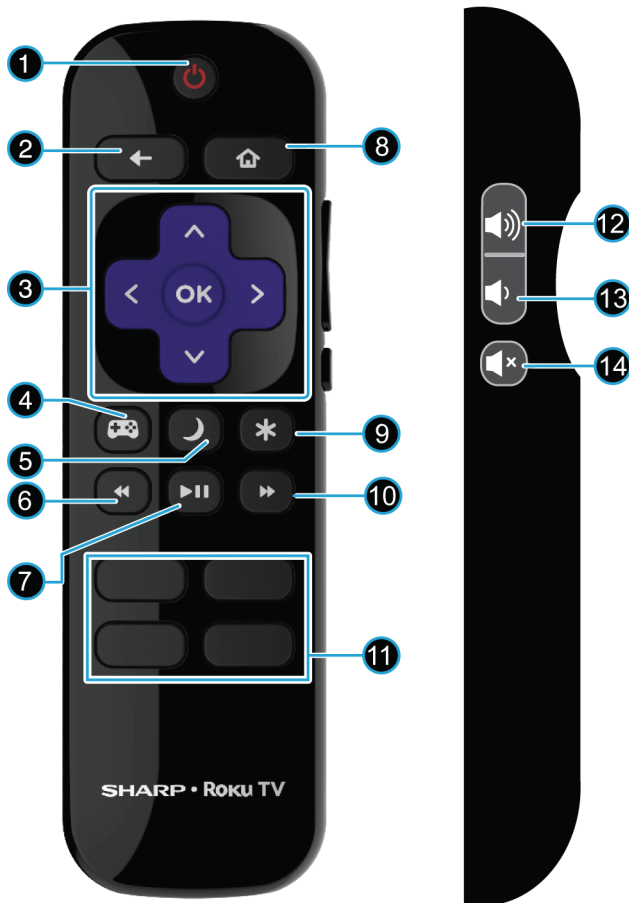



Remote control



#	Button	Description
1	⏻ (power)	If your TV is in Standby mode, turns power on. If your TV is on, puts your TV in Standby mode.
2	← (back)	The action depends on what you are doing with your TV: Menu —Goes back to previous menu or screen. Home screen tile —Moves highlight back to the Home menu option. Watching Antenna TV or a TV input —Returns to the screen from which the input was selected. Playing streaming content —Stops playing stream and returns to the previous menu or screen. Browsing streaming content —Goes to the previous level in the content tree.

#	Button	Description
3	^ v < > and OK	<p>^—Moves the highlight up one item.</p> <p>v—Moves the highlight down one item.</p> <p><—Moves the highlight left, if possible (if a < hint appears).</p> <p>>—Moves the highlight to the right, if possible (if a > hint appears).</p> <p>OK—Selects the highlighted option.</p>
4	🎮 (Game Mode)	First press displays a banner showing the current Game mode, if applicable, or Not available at this time . Subsequent presses toggle Game mode. When On , your TV performs less image processing and has less input lag. When Off , your TV performs more image processing and has more input lag, which is less desirable for action games. Note: Available only for HDMI and AV inputs.
5	🌙 (sleep)	First press displays a banner showing the remaining sleep time, if any, or Sleep timer is off . Subsequent presses cycle among the preset sleep time intervals: 30 minutes, 1 hour, 1.5 hours, 2 hours, and 3 hours . Once set, the Sleep timer remains in effect regardless of what you are watching.
6	⏮ (rewind)	<p>When playing streaming video that supports this feature:</p> <ul style="list-style-type: none"> • First press rewinds at 1x speed. • Second press rewinds at 2x speed. • Third press rewinds at 3x speed. • Subsequent presses cycle through 1x, 2x, and 3x rewind speed. <p>When playing streaming audio, jumps to the previous track/selection.</p> <p>When any menu, tile, or channel in the channel list is highlighted, jumps up one page.</p> <p>When using a virtual keyboard, jumps to the character at the top of the current column.</p>
7	⏸ (play/pause)	When playing streaming content, alternately pauses and plays the content.
8	🏠 (home)	Immediately returns to the Home screen menu.
9	* (options)	Displays an <i>Options</i> menu, but only when the Options * hint in the upper right corner of the screen is not dimmed. The menu you see varies depending on what you are doing with your TV. Also, in most cases, pressing * while video is playing displays an <i>Options</i> menu over part of the screen where you can adjust various picture and sound settings.
10	⏭	<p>When playing streaming video that supports this feature:</p> <ul style="list-style-type: none"> • First press fast forwards at 1x speed. • Second press fast forwards at 2x speed. • Third press fast forwards at 3x speed. • Subsequent presses cycle through 1x, 2x, and 3x fast forward speed. <p>When playing streaming audio, jumps to the next track/selection.</p> <p>When any menu, tile, or channel in the channel list is highlighted, jumps down one page.</p> <p>When using a virtual keyboard, jumps to the character at the bottom of the current column.</p>

#	Button	Description
11	FEATURED CHANNEL SHORTCUT	<p>Dedicated buttons show the logo of a featured streaming content provider. Pressing a button turns your TV on (if your TV is not already on), and if your TV is operating and is connected to the Internet, performs one of the following actions:</p> <ul style="list-style-type: none"> Displays the streaming channel's main page if you have already added the channel to your Home screen. Displays the streaming channel's sign-up page if you have not already added the channel so that you can agree to any terms and fees for the service.
12	 (volume up)	<p>Turns volume up one setting with each press. Press and hold to turn volume up rapidly. A volume indicator shows the volume level while you are adjusting the volume and for a few seconds afterward.</p> <p>Note: If your TV is muted, pressing  unmutes the sound.</p>



#	Button	Description
13	 (volume down)	<p>Turns volume down one setting with each press. Press and hold to turn volume down rapidly. A volume indicator shows the volume level while you are adjusting the volume and for a few seconds afterward.</p> <p>Note: If your TV is muted, pressing  does not unmute the sound.</p>
14		<p>Mutes and unmutes the TV sound. A volume indicator shows the current volume level and a mute icon when you press  and for a few seconds afterward. If Closed captioning is set to When Mute, captions are displayed while your TV is muted.</p>

What connection should I use?

Your TV has several connection types for connecting devices to your TV.

For the best video quality, you should connect a device to the best available connection.

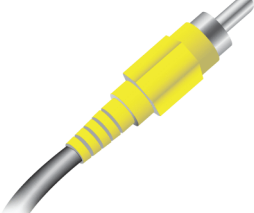
Use the following tables to identify cables:

Video quality	Connection type and jack	Cable connector
Best (use this if your devices have HDMI)	HDMI video/audio	
Good	AV (composite video) (requires an audio connection)	
Good	Coaxial video/audio	

Connection type and jack	Cable connector
--------------------------	-----------------

SPDIF optical digital audio output



Analog audio input

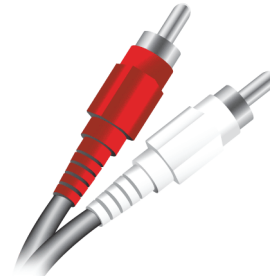

3.5mm analog audio output



Cautions

- Check the jacks for position and type before making any connections.
- Loose connections can cause poor audio or video quality. Make sure that all connections are tight and secure.
- The external audio/video devices shown may be different from your devices. If you have questions, refer to the documentation that came with your devices.
- Always turn off your TV when connecting external devices.

Connecting a cable or satellite box

Many cable or satellite TV boxes have more than one connection type. To get the best video, you should use the best connection type available. For more information, see [What connection should I use?](#) on page 14.

You can connect your cable or satellite box using:

- [HDMI \(best\)](#)
- [AV \(composite video\) \(good\)](#)
- [Coaxial \(good\)](#)

HDMI (best)

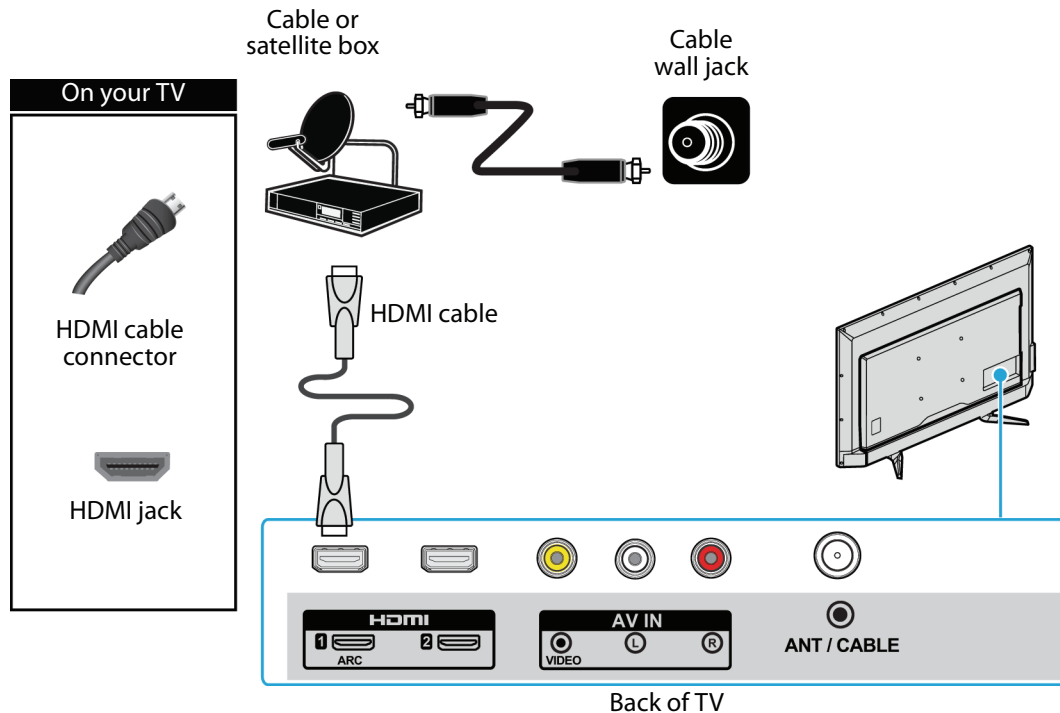

- 1 Make sure that your TV's power cord is unplugged and all connected devices are turned off.
- 2 Connect the incoming cable from the cable wall jack to the cable-in jack on the cable or satellite box.
- 3 Connect an HDMI cable (not provided) to an **HDMI** jack on the side or back of your TV and to the **HDMI OUT** jack on the cable or satellite box.
- 4 Plug your TV's power cord into a power outlet, turn on your TV, then turn on the cable or satellite box.
- 5 On the Home screen, press **^** **v** **<** or **>** to highlight the **HDMI 1**, **HDMI 2**, or **HDMI 3** tile, then press **OK**.

Note

An HDMI cable carries both audio and video. You do not need to use any audio cables.

AV (composite video) (good)

Notes

Cables are often color-coded to match color-coded jacks.

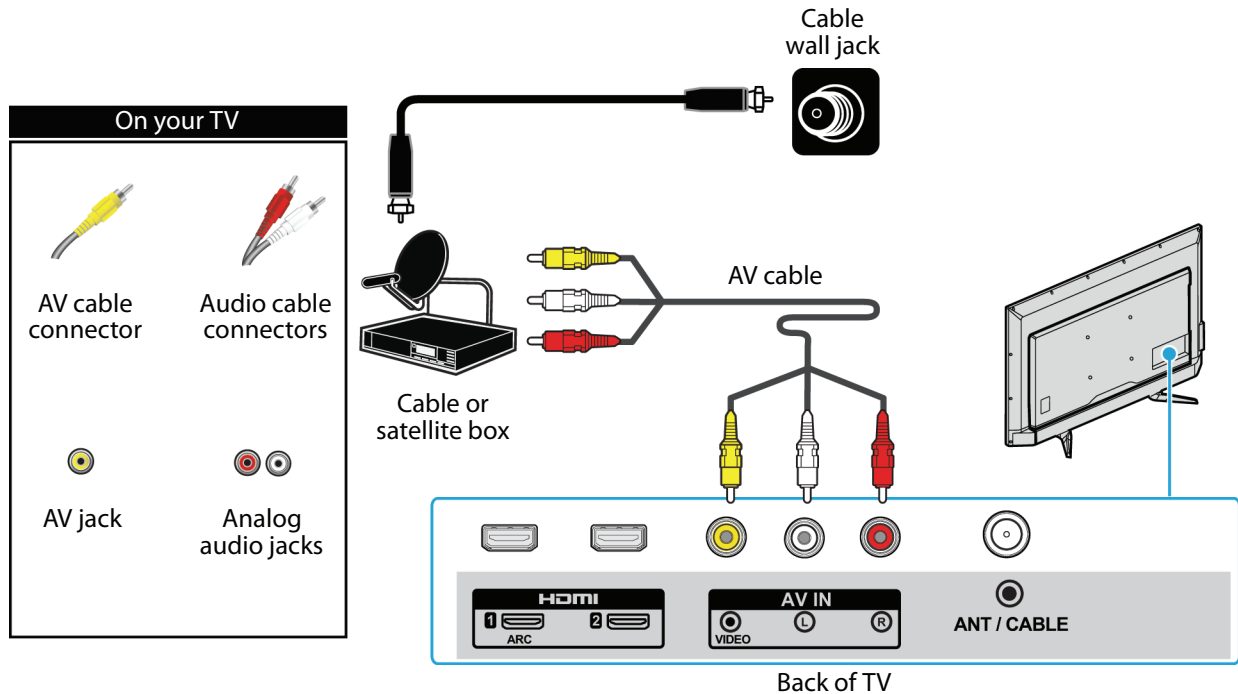

- 1 Make sure that your TV's power cord is unplugged and all connected devices are turned off.
- 2 Connect the incoming cable from the cable wall jack to the cable-in jack on the cable or satellite box.
- 3 Connect an AV cable (not provided) to the **VIDEO** jack and **L** and **R** (audio) jacks on the back of your TV and to the AV and audio out jacks on the cable or satellite box.

Note

When you connect the audio using the **L** and **R** (audio) jacks, the audio output is analog.

- 4 Plug your TV's power cord into a power outlet, turn on your TV, then turn on the cable or satellite box.
- 5 On the Home screen, press **^** **v** **<** or **>** to highlight the **AV** tile, then press **OK**.

Coaxial (good)

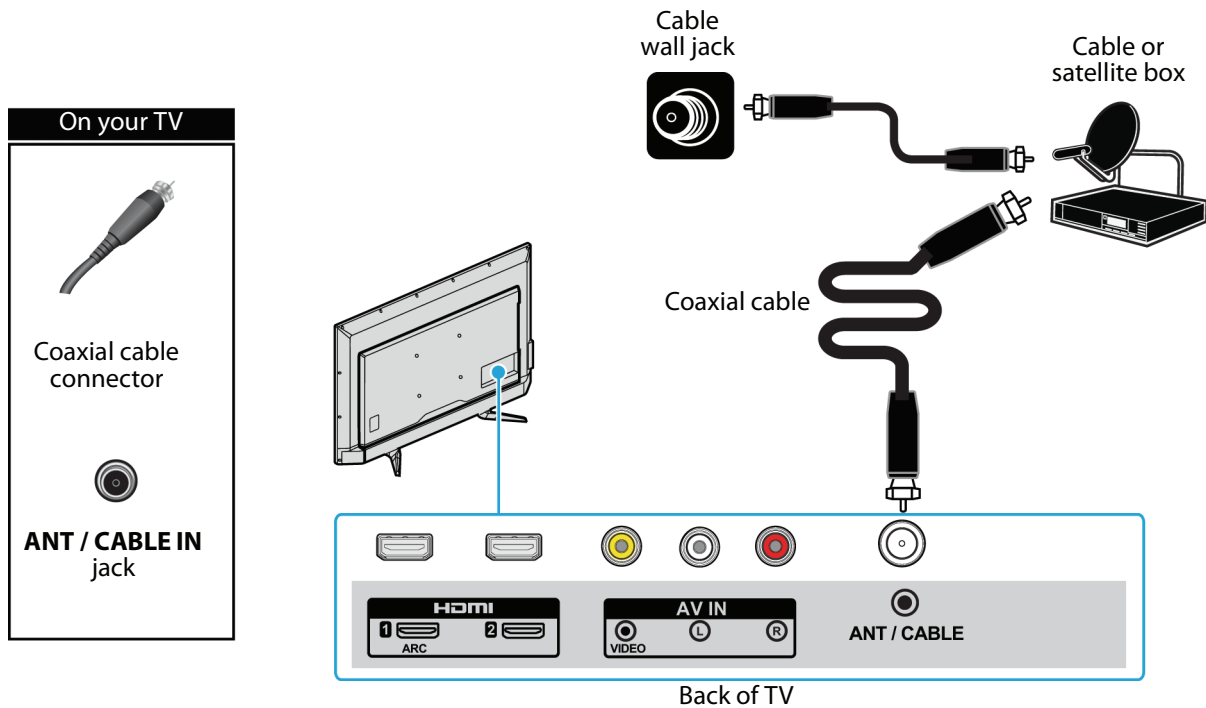

- 1 Make sure that your TV's power cord is unplugged and all connected devices are turned off.
- 2 Connect the incoming cable from the cable wall jack to the cable-in jack on the cable or satellite box.
- 3 Connect a coaxial cable (not provided) to the **ANT / CABLE IN** jack on the back of your TV and to the coaxial out jack on the cable or satellite box.
- 4 Plug your TV's power cord into a power outlet, turn on your TV, then turn on the cable or satellite box.
- 5 Set up the TV tuner to watch broadcast TV. See [Setting up Antenna TV](#) on page 41.
- 6 On the Home screen, press **^** **v** **<** or **>** to highlight the **Antenna TV** tile, then press **OK**.

Notes

- Use a coaxial cable to eliminate interference and noise from radio waves.
- Do not bundle the coaxial cable with the power cord or other cables.

Connecting an antenna or cable TV (no box)

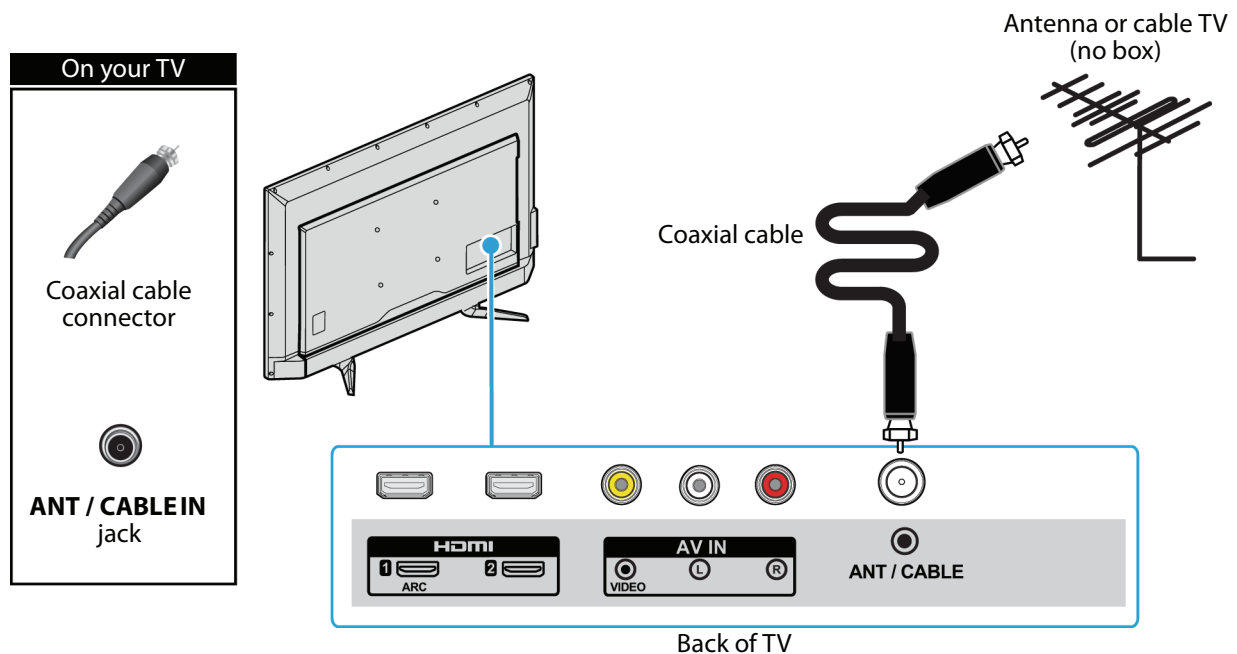

- 1 Make sure that your TV's power cord is unplugged and all connected devices are turned off.
- 2 Connect a coaxial cable (not provided) to the **ANT / CABLE IN** jack on the back of your TV and to the antenna or cable TV wall jack.
- 3 Plug your TV's power cord into a power outlet, then turn on your TV.
- 4 On the Home menu, press $\wedge \vee < >$ to highlight the tile for **Antenna TV**, then press **OK**.
- 5 Set up the TV tuner to watch broadcast TV. See [Setting up Antenna TV](#) on page 41.
- 6 On the Home screen, press $\wedge \vee < >$ to highlight the **Antenna TV** tile, then press **OK**.

Notes

- Use a coaxial cable to eliminate interference and noise from radio waves.
- Do not bundle the coaxial cable with the power cord or other cables.
- If the antenna is not installed correctly, contact qualified service personnel to correct the problem.
- If the signal level for a channel is weak, the picture may be distorted. Adjust the antenna or use a highly directional outdoor or set-top antenna with a built-in amplifier.
- If the picture quality is good on some channels and poor on others, the problem may be caused by a poor or weak signal from the broadcaster or cable TV provider.
- If you connect to cable TV without a set-top box and experience poor picture quality, you may need to install a set-top box to improve signal reception and picture quality. Contact your cable TV provider about upgrading to a set-top box.
- Many high-definition (HD) channels upscale standard-definition (SD) content. The picture displayed on your TV is still displayed as SD, thus the picture quality will not be as clear or crisp as it would be if the content was originally recorded in HD.

Connecting a DVD or Blu-ray player

Many DVD or Blu-ray players have more than one connection type. To get the best video, you should use the best connection type available. For more information, see [What connection should I use?](#) on page 14.

You can connect a DVD or Blu-ray player using:

- **HDMI (best)**
- **AV (composite video) (good)**

HDMI (best)

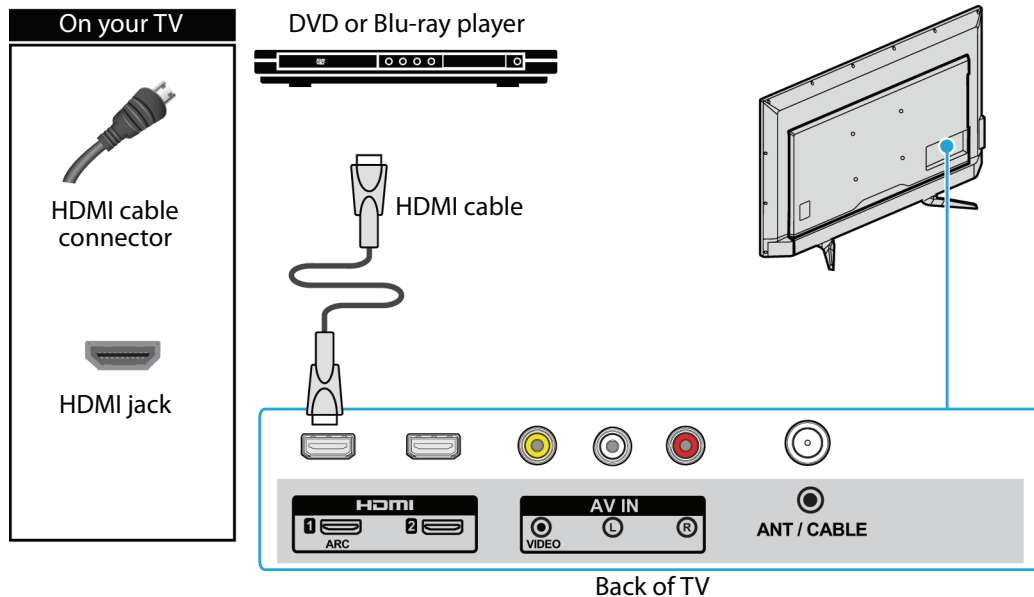

- 1 Make sure that your TV's power cord is unplugged and the DVD or Blu-ray player is turned off.
- 2 Connect an HDMI cable (not provided) to an **HDMI** jack on the side or back of your TV and to the **HDMI OUT** jack on the DVD or Blu-ray player.
- 3 Plug your TV's power cord into a power outlet, then turn on your TV and DVD or Blu-ray player.
- 4 On the Home screen, press **^** **v** **<** or **>** to highlight the **HDMI 1**, **HDMI 2**, or **HDMI 3** tile, then press **OK**.

Note

An HDMI cable carries both audio and video. You do not need to use any audio cables.

AV (composite video) (good)

Note

Cables are often color-coded to match color-coded jacks.

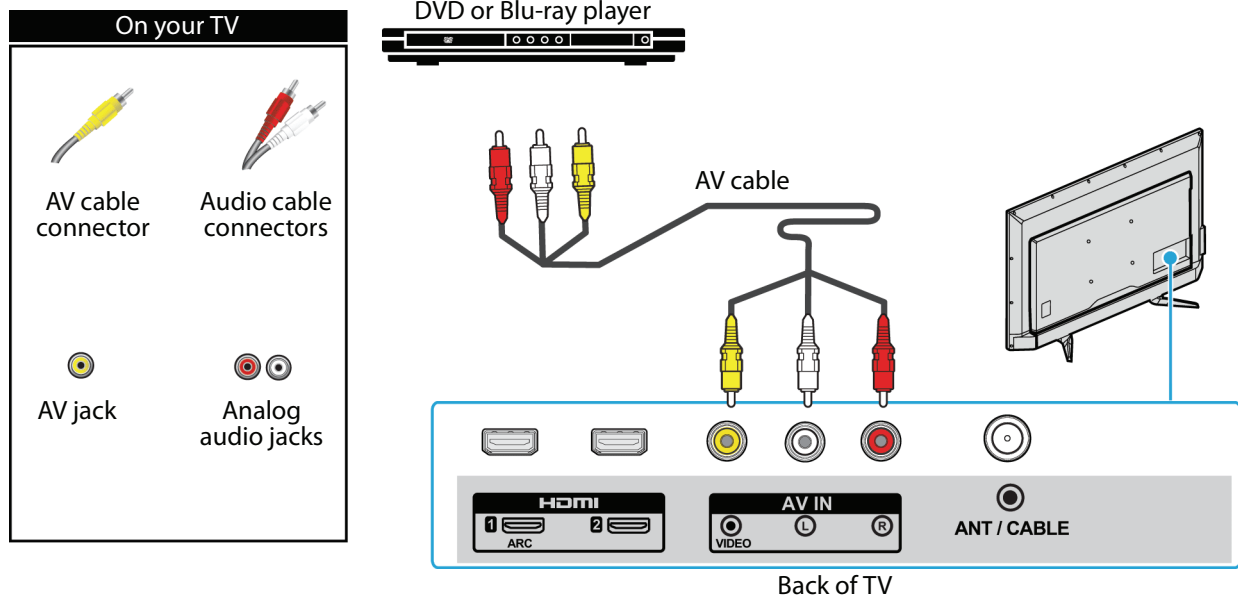

- 1 Make sure that your TV's power cord is unplugged and the DVD or Blu-ray player is turned off.
- 2 Connect an AV cable (not provided) to the **VIDEO** jack and **L** and **R** (audio) jacks on the back of your TV and to the **AV OUT** jacks on the DVD or Blu-ray player.

Note

When you connect the audio using the **L** and **R** (audio) jacks, the audio output is analog.

- 3 Plug your TV's power cord into a power outlet, then turn on your TV and DVD or Blu-ray player.
- 4 On the Home screen, press **^** **v** **<** or **>** to highlight the **AV** tile, then press **OK**.

Connecting a game console

Many game consoles have more than one connection type. To get the best video, you should use the best connection type available. For more information, see [What connection should I use?](#) on page 14.

You can connect a game console using:

- [HDMI \(best\)](#)
- [AV \(composite video\) \(good\)](#)

HDMI (best)

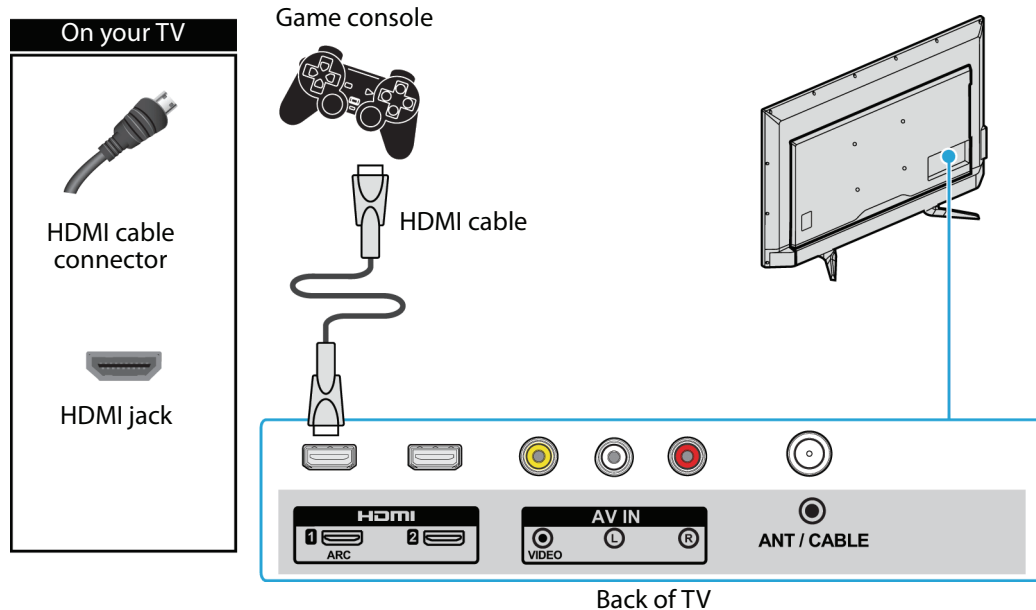

- 1 Make sure that your TV's power cord is unplugged and the game console is turned off.
- 2 Connect an HDMI cable (not provided) to an **HDMI** jack on the side or back of your TV and to the **HDMI OUT** jack on the game console.
- 3 Plug your TV's power cord into a power outlet, then turn on your TV and the game console.
- 4 On the Home screen, press **^** **v** **<** or **>** to highlight the **HDMI 1**, **HDMI 2**, or **HDMI 3** tile, then press **OK**.

Note

An HDMI cable carries both audio and video. You do not need to use any audio cables.

AV (composite video) (good)

Note

Cables are often color-coded to match color-coded jacks.

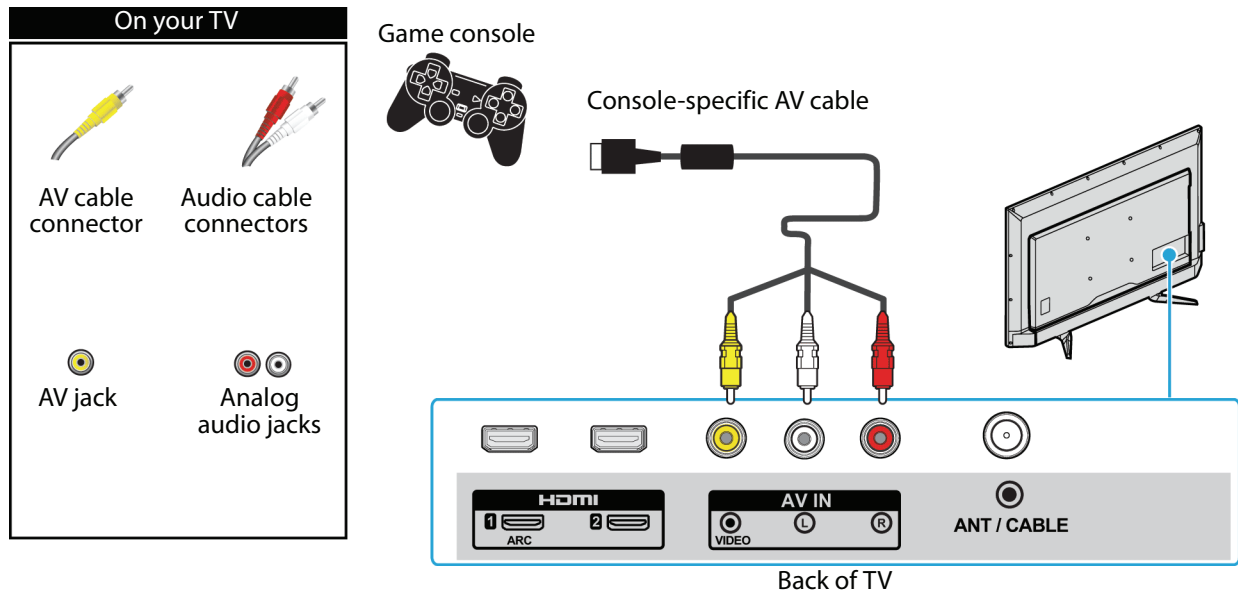

- 1 Make sure that your TV's power cord is unplugged and the game console is turned off.
- 2 Connect the game console's AV cable (not provided) to the **VIDEO** jack and **L** and **R** (audio) jacks on the back of your TV and to the composite jack(s) on the game console.

Note

- Most game consoles come with a special AV cable. See the documentation that came with your game console or check the manufacturer's Web site.
- When you connect the audio using the **L** and **R** (audio) jacks, the audio output is analog.

- 3 Plug your TV's power cord into a power outlet, then turn on your TV and the game console.
- 4 On the Home screen, press **^** **v** **<** or **>** to highlight the **AV** tile, then press **OK**.

SHARP • Roku TV

Connecting a computer

LC-43LB371U/LC-50LB371U 43"/50" 1080p, 60Hz, LED Sharp Roku TV

You can use an HDMI jack on your TV to connect to a computer.

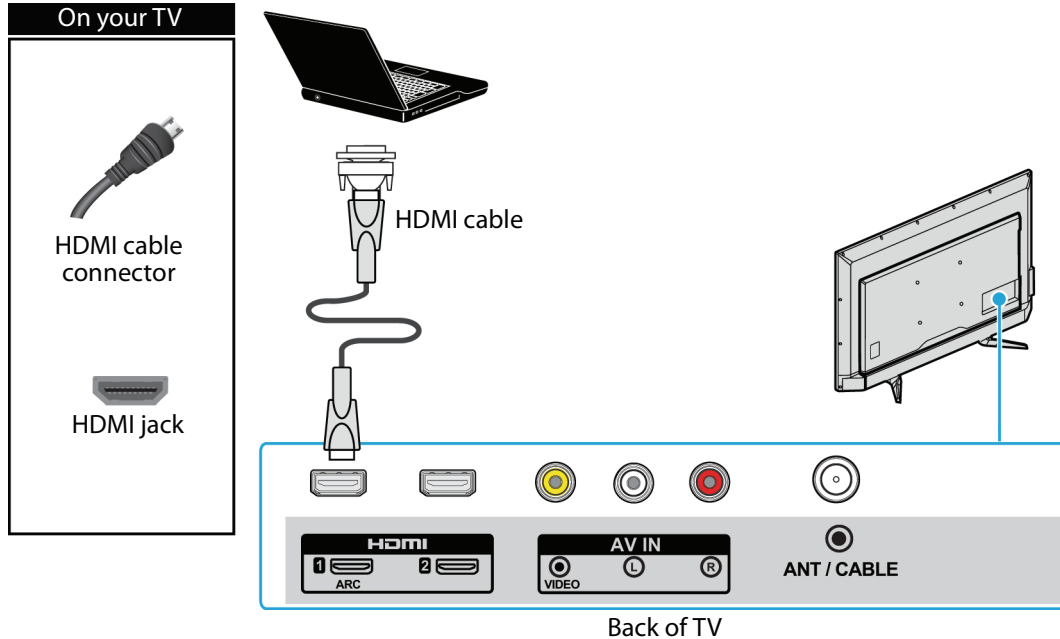

- 1 Make sure that your TV's power cord is unplugged and the computer is turned off.
- 2 Connect an HDMI cable (not provided) to an **HDMI** jack on the side or back of your TV and to the **HDMI OUT** jack on the computer.
- 3 Plug your TV's power cord into a power outlet, then turn on your TV and the computer.
- 4 On the Home screen, press **^** **v** **<** **>** to highlight the **HDMI 1**, **HDMI 2**, or **HDMI 3** tile, then press **OK**.
- 5 Adjust the display properties on the computer, if necessary.

Connecting a USB flash drive

You can use the USB jack on your TV to view photos and videos and listen to music stored on a USB flash drive.

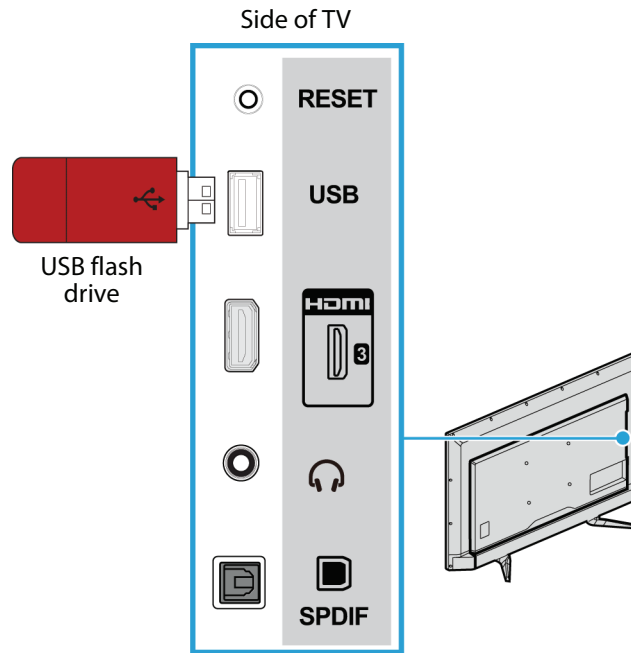

- 1 Plug a USB flash drive into the **USB** port on the side of your TV.

Caution

Do not remove the USB flash drive or turn off your TV while using the USB flash drive. You may lose data or damage the USB flash drive.

- 2 Press **▲** or **▼** to highlight the **Roku Media Player** or **USB Media Player** tile, then press **OK**.

Connecting headphones

When you connect headphones, your TV speakers are muted and sound only plays through the headphones.

Warning

Loud noise can damage your hearing. When using headphones, use the lowest volume setting on your headphones that still lets you hear the sound.

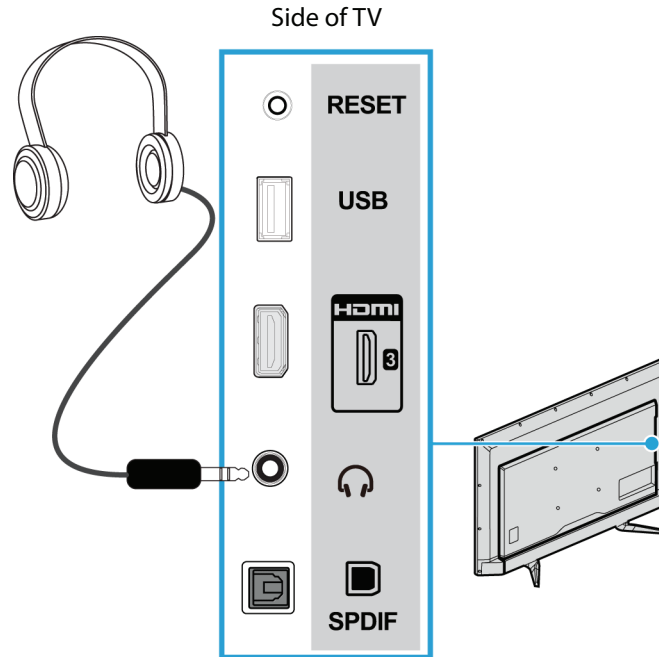

- Connect the headphones to the  jack on the side of your TV.

Note

You can also connect a home theater system, sound bar, or external speaker system to the  jack.

Connecting external speakers or a sound bar

When you connect external speakers or a sound bar, sound plays through your TV speakers and the external speakers or sound bar.

You can connect external speakers or a sound bar using:

- Digital audio using the SPDIF jack
- Digital audio using the HDMI 1/ARC jack
- Analog audio

Digital audio using the SPDIF jack

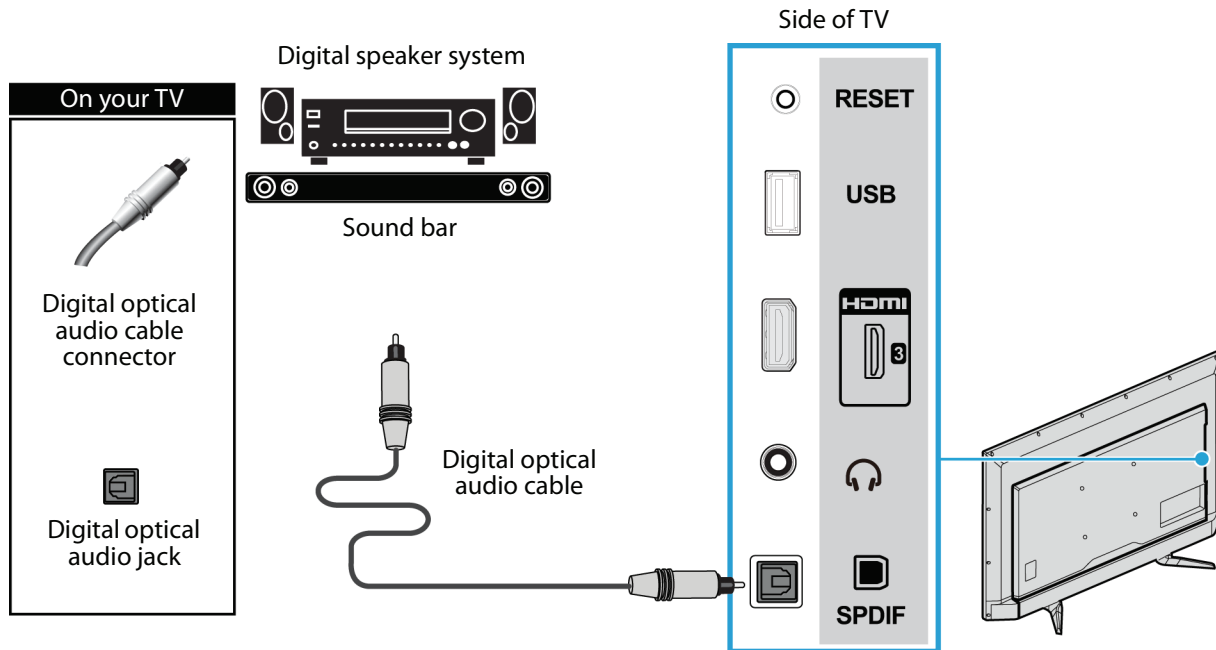

- 1 Make sure that your TV's power cord is unplugged and the digital speaker system or sound bar is turned off.
- 2 Connect a digital optical audio cable (not provided) to the **SPDIF** jack on the side of your TV and to the digital optical **AUDIO IN** jack on the digital speaker system or sound bar.
- 3 Plug your TV's power cord into a power outlet, then turn on your TV.
- 4 Turn on the digital speaker system or sound bar, then set it to the correct source. For more information, see the documentation that came with the digital speaker system or sound bar.
- 5 To turn off your TV speakers, on the Home menu, press \wedge or \vee to highlight **Settings**, then press **OK**. Highlight **Audio**, then press **OK**. Highlight **TV speakers**, then press **OK**. Press **OK** to remove the check from the **TV speakers enabled** check box.

Digital audio using the HDMI 1/ARC jack

Your TV can send sound to an ARC device, like an AV receiver, to create a home theater that uses two or more speakers. When you connect external speakers or a sound bar, sound plays through your TV speakers and the external speakers or sound bar.

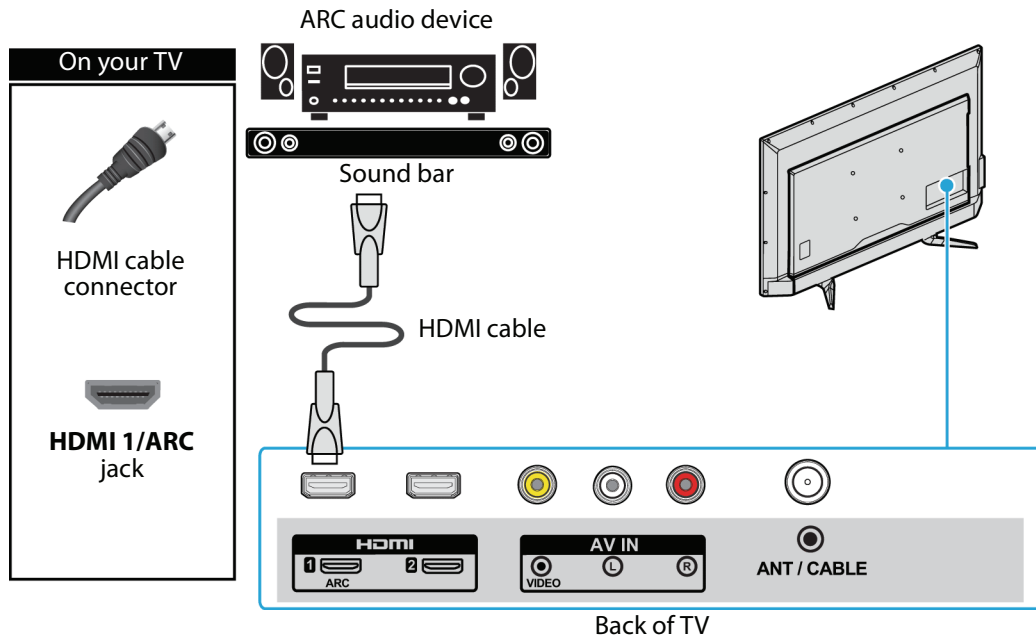

- 1 Make sure that your TV's power cord is unplugged and the digital speaker system or sound bar is turned off.
- 2 Connect an HDMI cable (not provided) to the **HDMI 1/ARC** jack on the back of your TV and to the **HDMI IN** jack on the digital speaker system or sound bar.
- 3 Plug your TV's power cord into a power outlet, then turn on your TV.
- 4 Turn on the digital speaker system or sound bar, then set it to the correct source. For more information, see the documentation that came with the digital speaker system or sound bar.
- 5 To turn off your TV speakers, on the Home menu, press **^** or **v** to highlight **Settings**, then press **OK**. Highlight **Audio**, then press **OK**. Highlight **TV speakers**, then press **OK**. Press **OK** to remove the check from the **TV speakers enabled** check box.
- 6 To configure the **HDMI 1/ARC** jack to output sound to an ARC device, on the Home menu, press **^** or **v** to highlight **Settings**, then press **OK**. Highlight **System**, then press **OK**. Highlight **Control other devices (CEC)**, then press **OK**. Highlight **HDMI ARC**, then press **OK** to check the box.

Analog audio

When you connect an analog system or sound bar to the  jack, your TV speakers are muted.

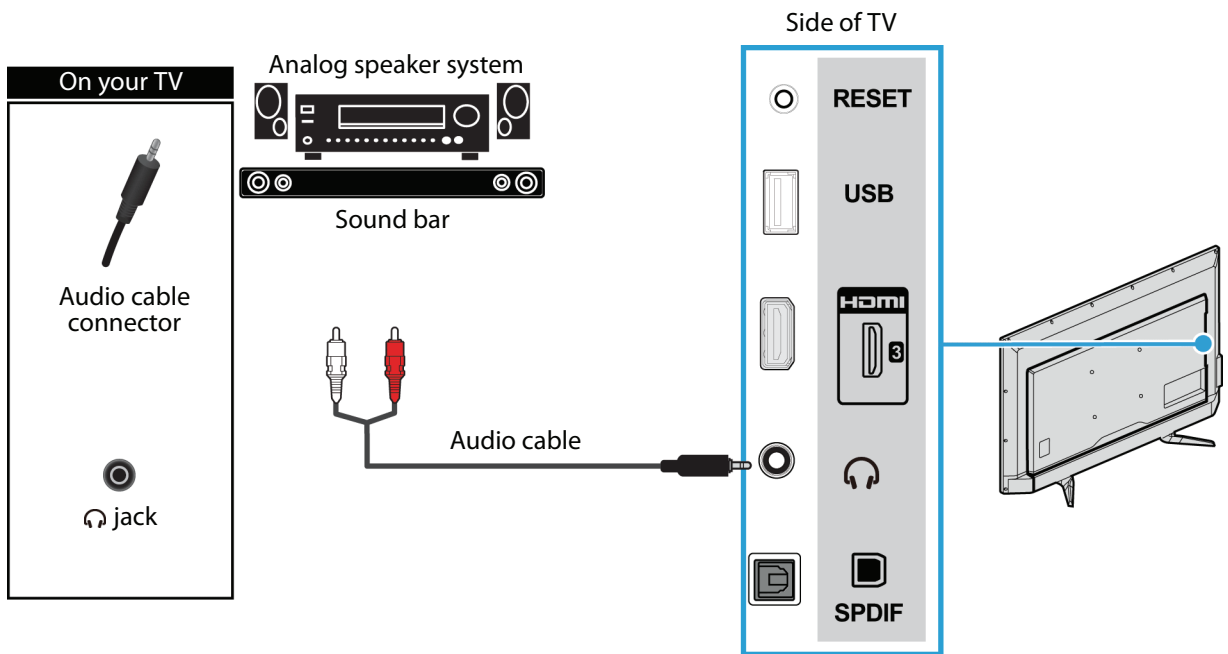

- 1 Make sure that your TV's power cord is unplugged and the analog speaker system or sound bar is turned off.
- 2 Connect an audio cable (not provided) to the  jack on the side of your TV and to the **AUDIO IN** jacks on the analog speaker system or sound bar.
- 3 Plug your TV's power cord into a power outlet, then turn on your TV.
- 4 Turn on the analog speaker system or sound bar, then set it to the correct source. For more information, see the documentation that came with the analog speaker system or sound bar.

Connecting a home theater system with multiple devices

You can connect an AV receiver and your devices to create a home theater.

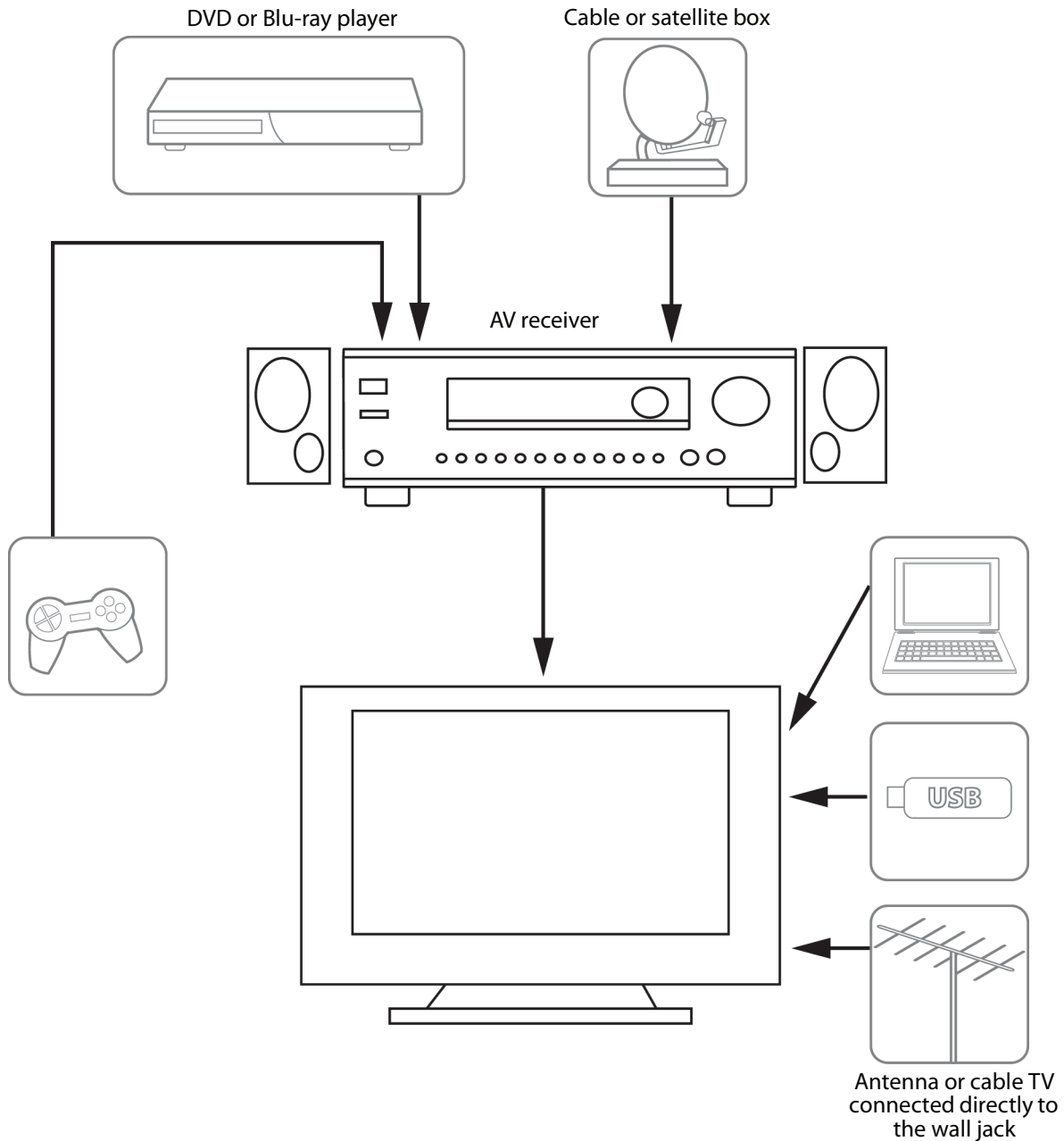

The connections you make depend on the video and audio jacks available on your devices. Refer to the documentation that came with your devices for connection information.

Just remember to use the best connection types available for the best picture and sound. For information about connection types, see [What connection should I use?](#) on page 14.

For information about TV settings for home theaters, see [Using your TV in a home theater](#) on page 65.

SHARP • Roku TV

Connecting power

LC-43LB371U/LC-50LB371U 43"/50" 1080p, 60Hz, LED Sharp Roku TV

You should connect devices **before** you connect the power cord. When you are adding devices, make sure that the power cable is unplugged from the power outlet.

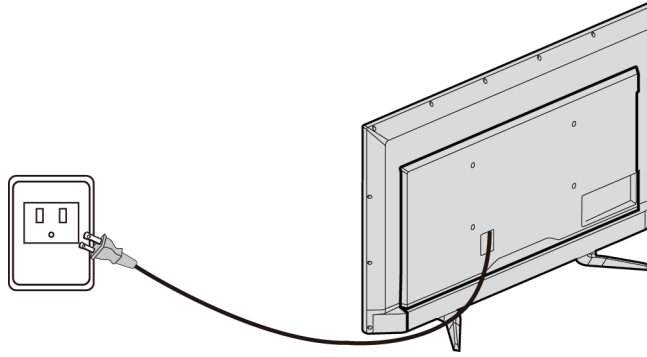

- 1 Connect the AC power cord to the power connector on the back of your TV.
- 2 Connect the other end of the cord to a power outlet.

Caution

- Your TV should only be operated from the power source indicated on the label.
- Always unplug the power cord from the power outlet when you will not be using your TV for an extended period of time.

Installing remote control batteries

Open the back of your TV remote control and insert two AAA batteries, observing the proper orientation. Reattach the back cover.

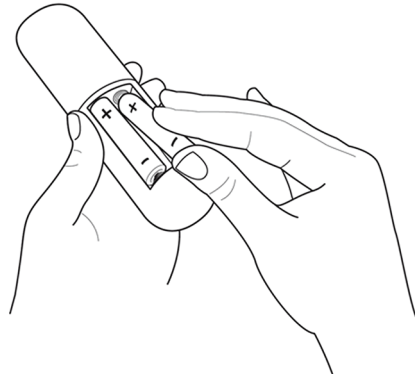

[Remote control](#) on page 12 explains how to use the remote control in each of your TV's operating modes.

Cautions

- Batteries should not be exposed to excessive heat, such as sunshine, heat registers, or fire.
- Battery chemicals can cause a rash. If the batteries leak, clean the battery compartment with a cloth. If chemicals touch your skin, wash immediately.
- Make sure that batteries are disposed of correctly. Do not burn or incinerate.

Notes

- Do not mix batteries of different types.
- Do not mix old and new batteries.
- Remove batteries when the charge is depleted.
- If the remote control is not going to be used for an extended period of time, remove the batteries.

Aiming the remote control

- Point the remote control towards the remote sensor on the front of your TV.

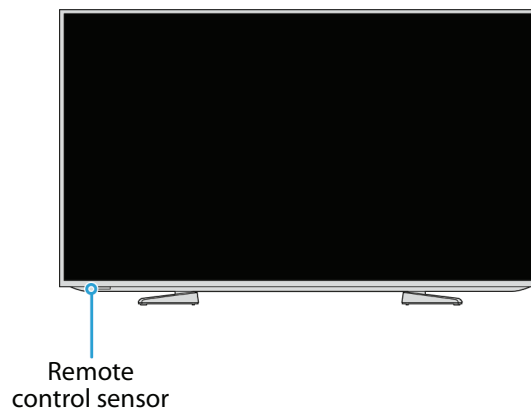

Guided Setup

With the preliminaries out of the way, it's time to turn on your TV. As your TV starts for the first time, it leads you through Guided Setup, which configures your TV before you start to use it.

During Guided Setup, you'll:

- Answer a few questions
- Provide network connection information
- Get a software update
- Link your TV to your Roku account.
- Connect devices such as a DVD player, game console, or cable box.

Note

Guided Setup only runs the first time you turn on your TV. If you need to run Guided Setup again, you'll have to perform a factory reset, as explained in [Factory reset everything](#) on page 67.

Preparing for Internet connectivity

If you want to connect your TV to the Internet to watch streaming content, you must connect using a wireless modem/router or a wireless access point. The TV connects through a built-in wireless LAN adapter. The TV does not support a wired connection or the use of a USB network adapter.

We recommend that your wireless connection supports the IEEE 802.11b/g/n specification for the best experience.

Starting Guided Setup

To start Guided Setup, press the **POWER** button on the remote control to turn on your TV.

When you first turn on your TV, it will take a few seconds to get itself ready. You'll notice the following things happening:

- 1 The status light blinks every time your TV is busy doing something; in this case it's powering up and getting ready for you.
- 2 The power-on screen appears and the status light blinks slowly for a few more seconds. The power-on screen displays the Insignia Roku TV logo while your TV starts up.
- 3 After a few seconds, Guided Setup starts:

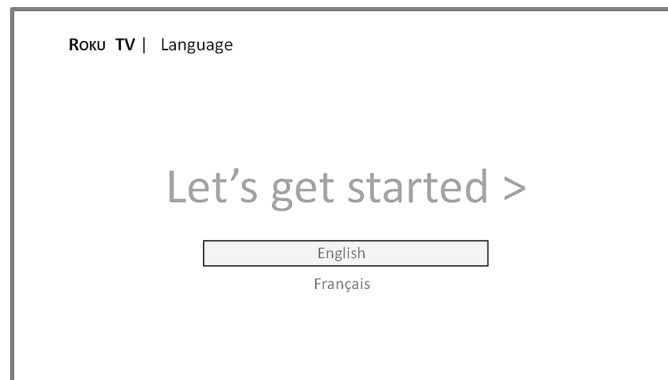

- 4 If your TV prompts you for a language, press the **DOWN** arrow on the remote control to highlight your preferred language.

Setting up your TV

With the first Guided Setup screen on your TV, follow these steps to set it up:

- 1 Press the **OK** or **RIGHT** arrow on the remote control to go to the next screen:

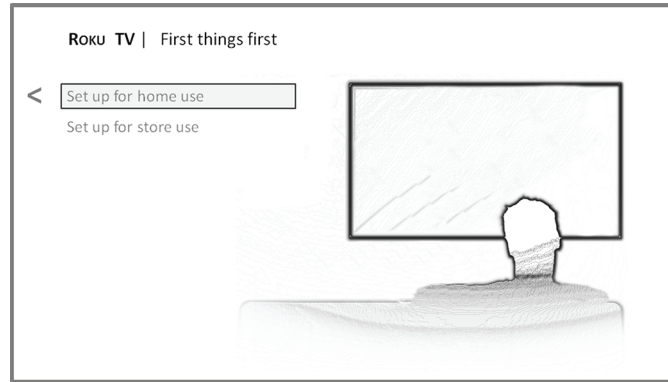

- 2 Press **OK** to select **Set up for home use**. Home mode is the right choice for enjoying your TV at home. It provides energy saving options as well as access to all features of your TV.

Note

Store mode configures your TV for retail display and is not recommended for any other use. In store mode, some features of your TV are missing or limited. To switch from one mode to the other, you have to perform a factory reset as explained in [Factory reset everything](#) on page 67, and then repeat Guided Setup.

After you select **Set up for home use**, your TV scans for the wireless networks within range and displays them in order, with the strongest signals first. In addition to your own wireless signal, your TV might pick up signals from your neighbors.

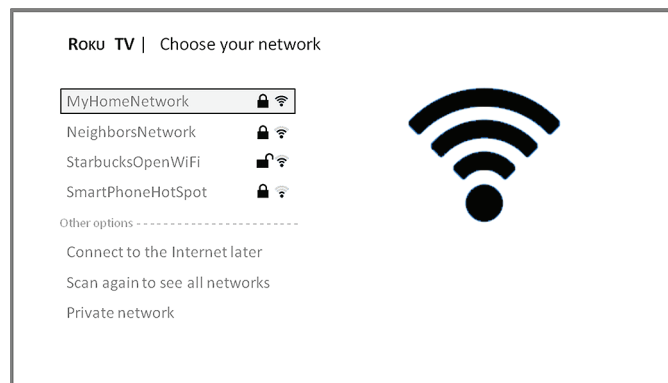

- 3 Press the **UP** or **DOWN** arrows to highlight the name of your wireless network, and then press **OK** to select it.

Note

Some wireless networks, such as those often found in dorm rooms, hotels, and other public places, may require you to read and agree to terms, enter a code, or provide identifying information before letting you connect to the Internet. If the Roku TV detects that you are connecting to such a network, it prompts you through the connection process using your compatible smartphone or tablet to provide the needed information. For more information, see [Using your TV in a hotel or dorm room](#) on page 47.

Other options:

- **Connect to the Internet later** —If you're unable to connect to the Internet, that's OK. You can skip this step and use your TV to watch broadcasts, play games, and watch DVDs. If you want to connect later, it's easy. We'll show you how in [Benefits of connecting](#) on page 40. Connecting your TV enables you to choose from thousands of streaming channels so your TV really wants you to connect, and will try a couple more times to convince you that connecting is a good idea.

Note

If you decide not to connect, Guided Setup skips ahead to setting up the devices that you've connected to your TV. See [Non-connected TV Home screen](#) on page 39 to get started using your non-connected TV.

- **Scan again / Scan again to see all networks**—This option depends on the number of wireless networks within range.
 - **Scan again** appears if the list already shows all available wireless networks within range. If you don't see your wireless network name in the list, you might need to adjust the location of your wireless router or your TV, turn on your router, or make other changes. When everything is ready, select **Scan again** to see if your network name now appears in the list.
 - **Scan again to see all networks** appears if your TV finds more than seven wireless networks, because your TV initially displays only the strongest seven networks. If you don't see your wireless network name in the list, this option displays the complete list. If you still don't see your network name, you might have your router configured to provide wireless service as a "private network."

Note

Highlighting either of these options displays an informational panel with the unique media access control (MAC) address of your TV. You will need the MAC address if your wireless router is configured to use MAC address filtering.

- **Private network**—If your wireless network name is hidden, it won't appear in the list. Select **Private network** to display an on-screen keyboard, and use it to enter your network name. Unless you changed the factory-set network name, you can find the name (also called SSID) on a label on the router.
- 4 If you select a network that is password-protected, an on-screen keyboard appears. Use the keyboard to enter the network password.

Tip

Wireless networks that are password-protected display a "padlock" icon adjacent to the name. This icon enables you to know that you are going to be prompted to enter a password after you select that network.

MyHomeNetwork  

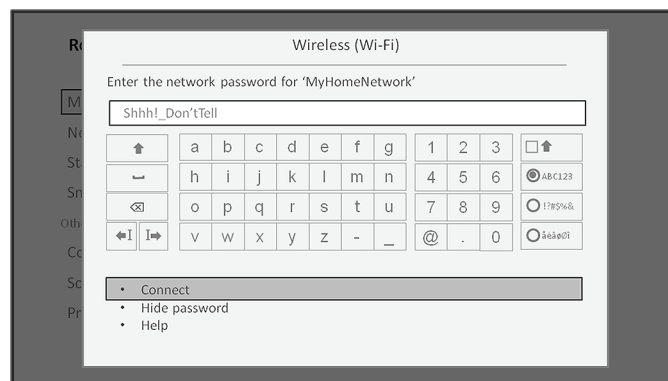

- 5 After you submit your network password, your TV displays progress messages as it connects to your wireless network, your local network, and the Internet.

- 6 Your TV needs to know the local time zone so that it can correctly display time information about the program you are currently watching. If your TV is unable to automatically determine the local time zone, it prompts you to choose your time zone from a list. Use the **UP** or **DOWN** arrows to highlight your time zone, and then press **OK**.

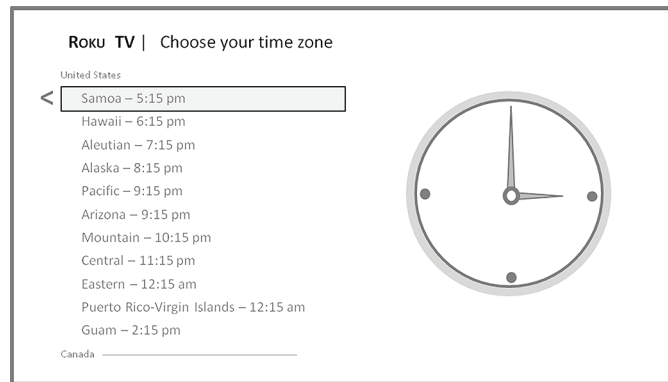

- 7 As soon as your TV is able to connect to the Internet, it downloads and installs its first software update, and then restarts.

Tips

- Your TV automatically checks for updates periodically. These updates provide new features and improve your overall experience with your TV. After an update, you might notice that some options have moved, and that there are new options or features. This *User Guide* describes version 7.0. To determine your current Roku TV software version, go to **Settings > System > About** after you complete Guided Setup.
- You can download an updated *User Guide* that matches your TV software version from the Insignia web site at: www.insigniaproducts.com/support.html

After your TV restarts, it displays the *Activation* screen:

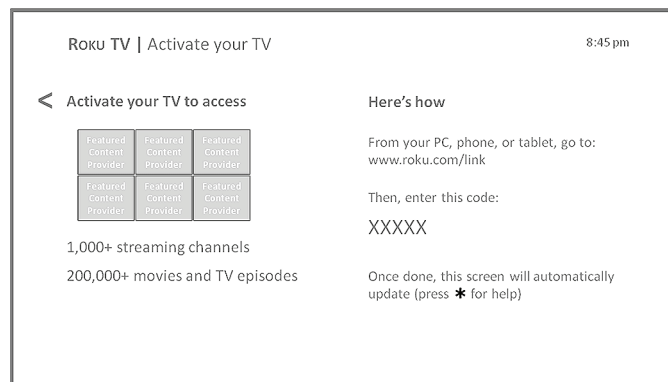

Note

A paid subscription or other payments may be required for some channels. Channel availability is subject to change and varies by country. Not all content is available in countries or regions where Roku products are sold.

- 8 Using a compatible computer, tablet, or smartphone with an Internet connection, go to the web address displayed on the screen and enter the code that appears on your screen.

After you log in or create your Roku account, your TV gets an acknowledgement and adds your preexisting streaming channels, if any, to your TV. This process is automatic and takes a few moments—a little longer if you already have a lot of streaming channels to add.

Tip

Streaming channels from all Roku devices associated with your account are synchronized periodically, so all of your Roku devices have the same streaming channels (subject to compatibility with the device).

Why do I need a Roku Account?

You need a Roku Channel Store account for several reasons.

- It links you, your TV and your other Roku devices to the Roku Channel Store and billing service.
- Streaming content providers know that it's OK to send content you request to your TV.
- Roku can automatically send updates to your device.

Important: It doesn't cost anything to use and maintain your Roku Channel Store account (other than the cost of the TV and Internet access). Your TV is packed with hundreds of free channels. Adding a payment method now lets you easily rent or buy movies on demand, or try popular transaction-based streaming channels.

After it adds your selected streaming channels, your TV helps you set up the devices that you're connecting to it, such as a cable box, Blu-ray player, or game console:

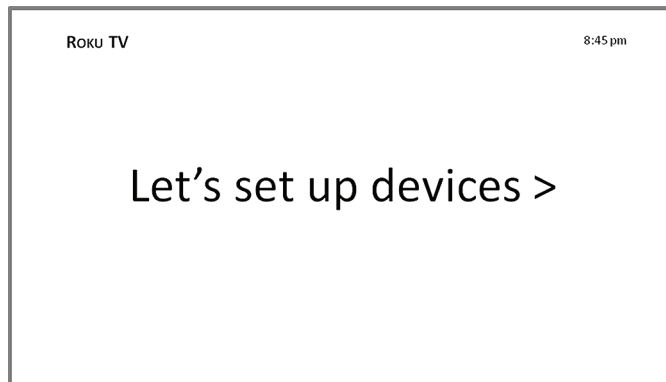

- 9 Press the **OK** or **RIGHT** arrow to proceed:

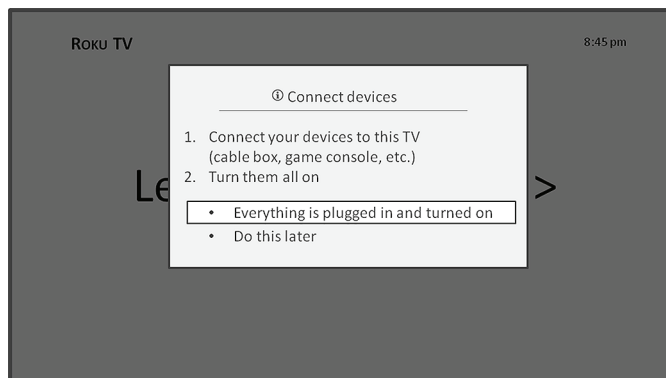

- 10** Connect all the devices you plan to use with your TV, turn them all on, and then select **Everything is plugged in and turned on**. Your TV now takes you step by step through each of its inputs and asks what kind of device you have connected. On each input that has a connected and active device, you can see its picture and hear its sound.

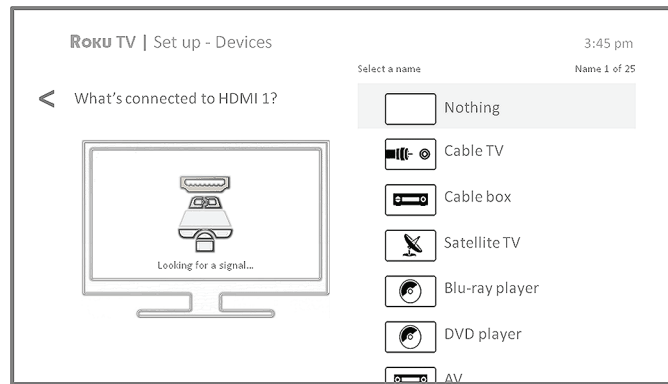



- 11** Press the **UP** or **DOWN** arrows to highlight the label you want to associate with the input, and then press **OK** to move on to the next input.

You're done with Guided Setup.



Tip

Some Roku TVs, depending on where you live and other factors, show you an introductory video filled with some great hints and tips. If you're not interested in viewing this video, press  on the remote control to exit to the Roku TV **Home** screen.

When you finish Guided Setup, and whenever you press  on the remote control, the **Home** screen greets you. From here, you can explore everything your TV has to offer. Press the arrow buttons to move around, and press **OK** to select a highlighted item. We've designed your TV to encourage you to explore, and you can probably figure out most of the capabilities and settings on your own. If you have any questions or difficulties, you can find answers and solutions in this guide.

If you find yourself a long way from the **Home** screen, you can always get back right away by pressing one button: .

Connected TV Home screen

Here is a typical **Home** screen from an TV that's connected to the Internet and paired with a Roku account.

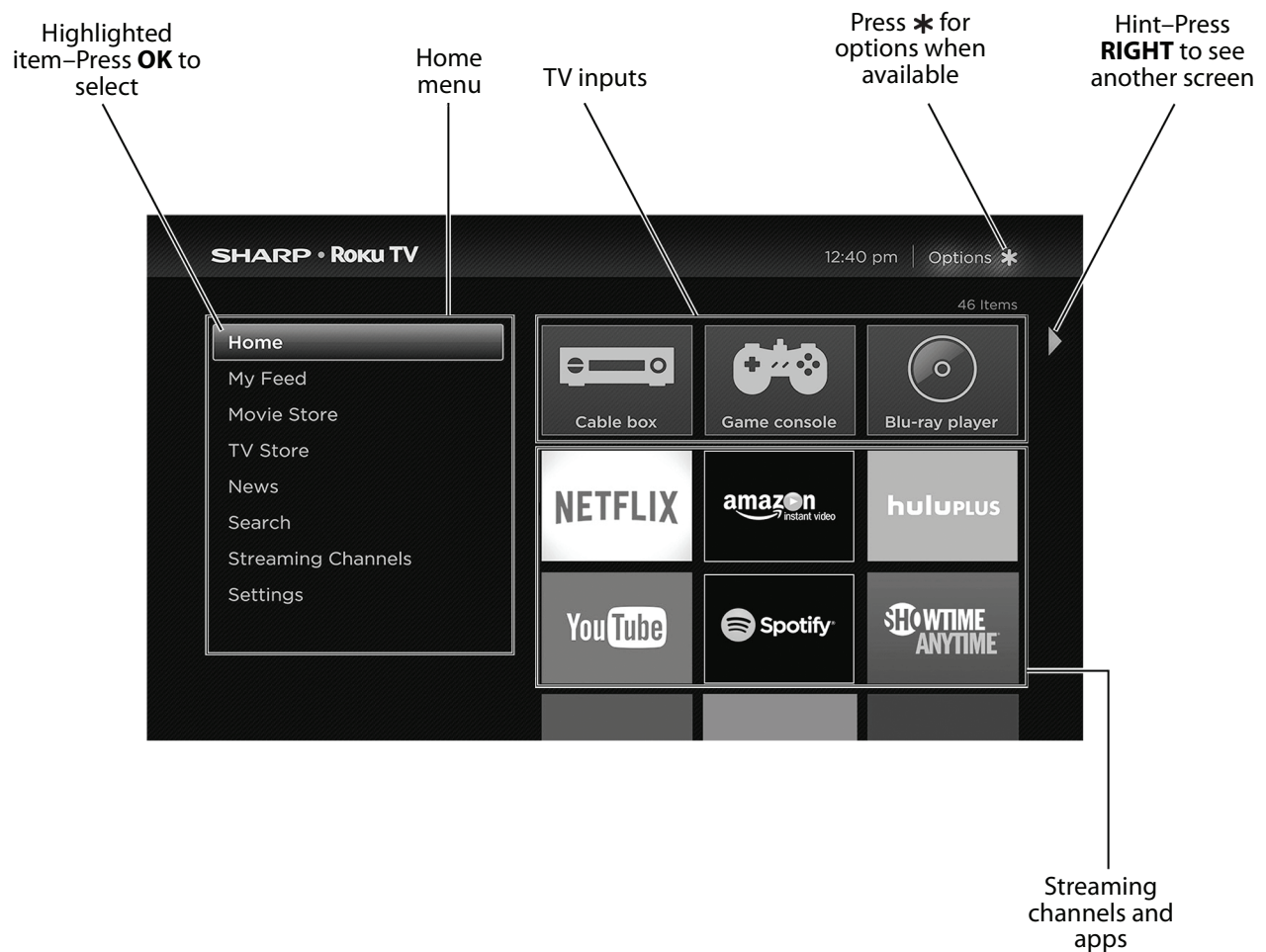

Personalize your Home screen

You can do a lot to personalize your **Home** screen and make it just right for you and your family:

- Add streaming channels by using the **Streaming Channels** menu option to browse the Roku Channel Store.
- Remove a tile by highlighting it and pressing *****. Then highlight **Remove input** or **Remove channel** and press **OK**.
- Reposition a tile by highlighting it and pressing *****. Then highlight **Move input** or **Move channel** and press **OK**. Use the arrow buttons to move the tile, and then press **OK** to lock it in its new location.
- Rename a TV input tile by highlighting it and pressing *****. Then highlight **Rename input** and press **OK**. Highlight a new name in the list, and then press **OK** to assign that name to the tile.
- Change the screen theme by going to **Settings > Themes** to find and pick one to suit your mood.
- Hide Movie Store, TV Store, or News, (US models only) as explained in [Blocking Movie Store, TV Store, and News \(US TV models only\)](#) on page 59.

Non-connected TV Home screen

Here is a typical **Home** screen from a TV that is not connected to the Internet.

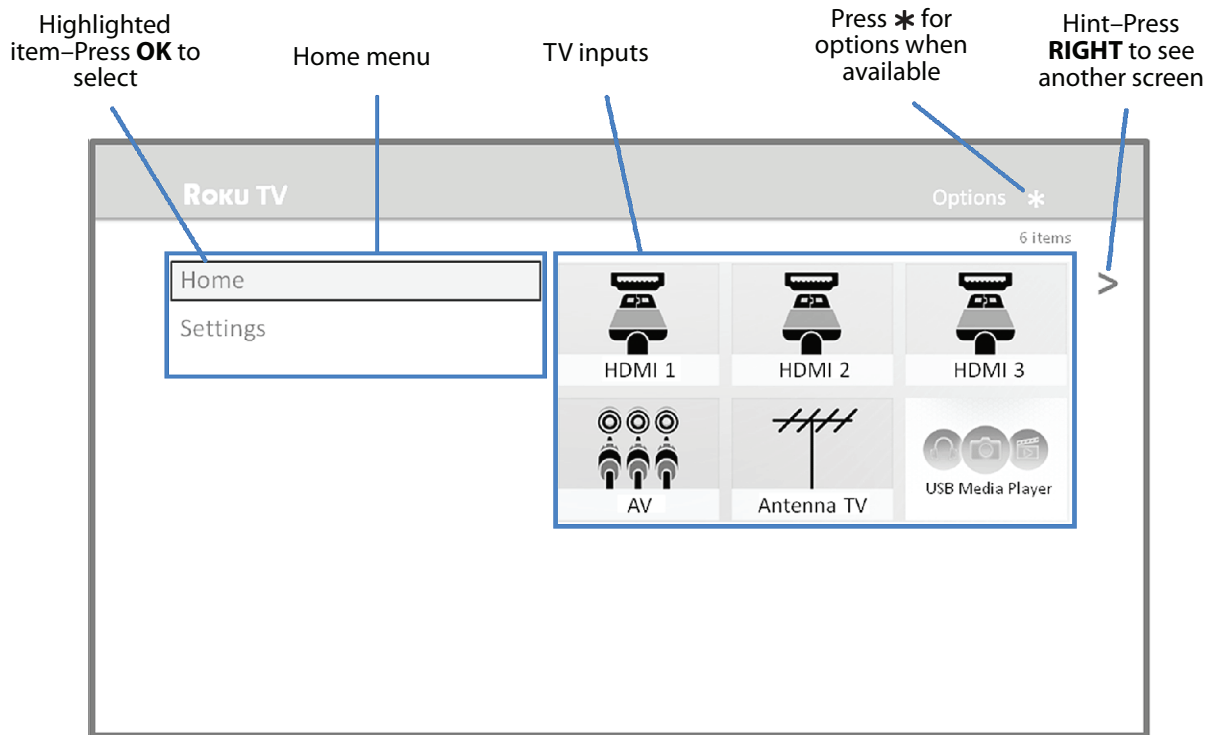

Personalize your Home screen

You can do a lot to personalize your **Home** screen and make it just right for you and your family:

- Remove a tile by highlighting it and pressing *. Then highlight **Remove input** and press **OK**.
- Reposition a tile by highlighting it and pressing *. Then highlight **Move input** and press **OK**. Use the arrow buttons to move the tile, and then press **OK** to lock it in its new location.
- Rename a tile by highlighting it and pressing *. Then highlight **Rename input** and press **OK**. Highlight a new name in the list, and then press **OK** to assign that name to the tile.
- Add streaming channels by browsing the Roku Channel Store (after connecting your TV to the Internet to add the **Streaming Channels** option to the menu).

SHARP • Roku TV

Benefits of connecting

LC-43LB371U/LC-50LB371U 43"/50" 1080p, 60Hz, LED Sharp Roku TV

Connecting brings out your TV's full potential!

Make any night a movie night

Thousands of movies to choose from, across all major streaming movie channels like Netflix, Cineplex Store, Crackle, and more. You'll never run out of something new to watch.

Note

A paid subscription or other payments may be required for some channels. Channel availability is subject to change and varies by country. Not all content is available in countries or regions where Roku products are sold

Get in the groove

Stream endless hours of music from channels free and subscription-based like Spotify, VEVO, and Rdio. With almost instant access to thousands of music artists, your favorite beats are just as close as your remote.

Explore your passions

In addition to popular streaming channels like YouTube, NHL, Sky News and Cineplex Store, your TV also offers hundreds of streaming channels to fuel your passions—including fitness, cooking, religion, outdoors, International programming and much more.

Enjoy FREE trials of popular channels

Your TV comes loaded with special offers, including free trials from popular streaming channels Netflix, Spotify, Rdio, DailyBurn Fitness, and many more. But remember that you must cancel before the free trial ends to avoid subscription fees.

What is streaming?

Streaming is viewing or listening to video or audio content that is sent over the Internet, or located on a network-connected media server or on a USB device plugged into your TV's USB port.

With streaming, you can buy or rent most programs on demand, when it's convenient for you. When streaming, you can play, pause, rewind, and fast forward whatever you are watching. You can also replay the last few seconds again, or turn on closed captions.

Tip

Some content cannot be paused or skipped. For example, if you are viewing live programming or a program that is supported by ads, you generally are not allowed to skip the ads.

Your TV lets you choose from thousands of streaming channels that offer a huge selection of entertainment:

- Thousands of movies and TV episodes
- Unlimited music, live and on-demand
- Tons of live and on-demand sports
- Commercial-free kids programming
- International programming in 22 languages
- 24x7 news and in-depth news commentary

Many streaming channels are free. Some streaming channels, like Cineplex and Amazon Instant Video, let you purchase or rent the latest movie releases or popular TV series. Some channels such as Netflix or Spotify charge a monthly subscription fee and others are free if you subscribe to a companion service through your cable or satellite provider. For example, HBO subscribers with participating broadcast TV provider accounts can add the HBO Go channel and watch it for free.

If you have an existing subscription to a service like Netflix or Spotify, you can just sign in with your existing user name and password.

To play streaming content that is available on the Internet, you add streaming channels to your **Home** screen. To add a streaming channel to your **Home** screen, use the **Streaming Channels** option on the **Home** screen menu to go to the Roku Channel Store, and then select the streaming channel you want to add. The streaming channel is then added to your **Home** screen, and you can watch it at any time.

For more information on using the Roku Channel Store feature, see [Using the Roku Channel Store](#) on page 55.

Note

A paid subscription or other payments may be required for some channels. Channel availability is subject to change and varies by country. Not all content is available in countries or regions where Roku products are sold

But what if I didn't connect my TV?

What if you went through Guided Setup and chose **Connect to the Internet later**? No worries. Your TV makes it easy to connect whenever you want. As you move around the **Home** screen, you'll see several places where you can start the connection process. For example:

- Now and then you'll see a message appear on the panel to the right of the **Home** screen offering a **Connect Now** option. Simply highlight and select the **Connect Now** option to get started.
- Use the **Connect and activate now** option in the *Settings* menu. From the **Home** screen menu, select **Settings, Network**, and then **Connect and activate now**.
- If you want to start over from the beginning, use the *Settings* menu to do a **Factory reset**, and then go through Guided Setup again. This time, choose your home network when prompted.

Regardless of how you connect, the process is the same. If you need details, see Step 3 on page 33 under [Setting up your TV](#).

Setting up Antenna TV

Despite all of the entertainment possibilities of your TV, you may also want to watch broadcast TV. You watch broadcast TV in much the same way you watch other entertainment choices. You select a tile—the **Antenna TV** tile—from the **Home** screen.

The first time you select the **Antenna TV** tile, you have to set up the TV tuner. Setting up the TV tuner scans for active channels and adds them to your broadcast TV channel list.

Why do I have to set up the TV tuner?

You might be asking, "Why is this step necessary?" Good question.

Not everyone needs to use the TV tuner. For example, you might have a set top box provided by a cable or satellite company that receives all of your channels. Most of these set top boxes use an HDMI® connection.

More and more people are watching only streaming TV and do not have a TV antenna or cable/satellite service. If you don't need the TV tuner, you can bypass setting it up and instead remove it from the **Home** screen as explained in [Remove unwanted tiles](#) on page 57.

When you set up Antenna TV, your TV scans the signals on its antenna input for channels with a good signal, and adds those to the channel list, skipping dead channels and channels with a very weak signal.

Your TV will, however, let you add two analog channels, even if they have no signal. You might need to add these channels if you have an older set top box, VCR, or game console that can only output a signal on analog channel 3 or 4. These are the only channels that can be added regardless of whether they have a good signal. Typically, you'll only need one of these channels, but both are provided to make setup simpler. You can hide the one you don't want as explained in [Edit broadcast TV channel lineup](#) on page 57.

How do I set up the TV tuner?

Setting up the TV tuner is easy—your TV does most of the work. You just have to answer a couple of questions.

- 1 Make sure your antenna (sold separately) or TV cable is connected to your TV's **ANT/CABLE** input.
- 2 On the **Home** screen, select the **Antenna TV** tile.
- 3 Read the simple on-screen instructions and select **Start finding channels**.

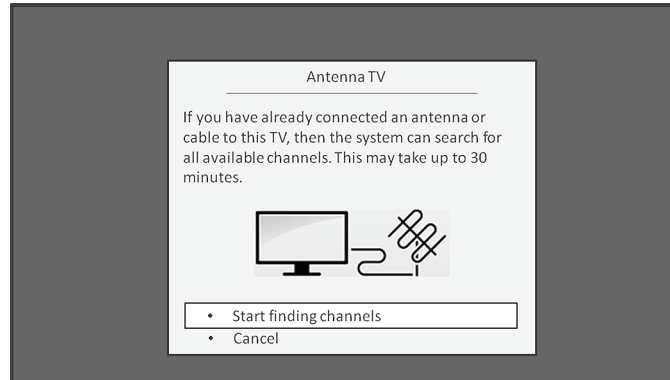

- 4 If prompted, select your time zone. You'll only need to do this if your TV can't figure out your time zone from your Internet connection.

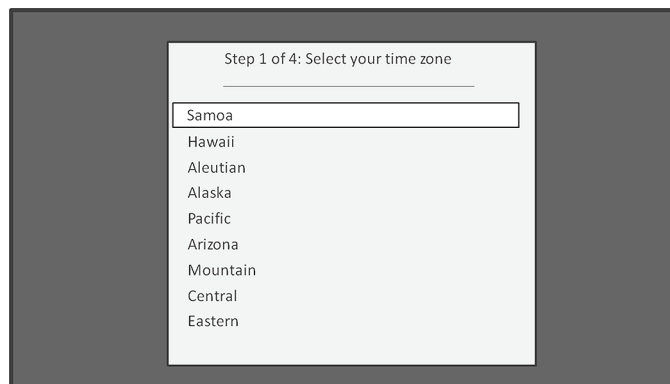

Why does the TV need my time zone?

The TV needs to know your time zone so that it can correctly display time information about the program you are currently watching.

- 5 When prompted, select whether to add analog channels 3 and 4 (to enable you to connect older set top boxes, VCRs, or game consoles).

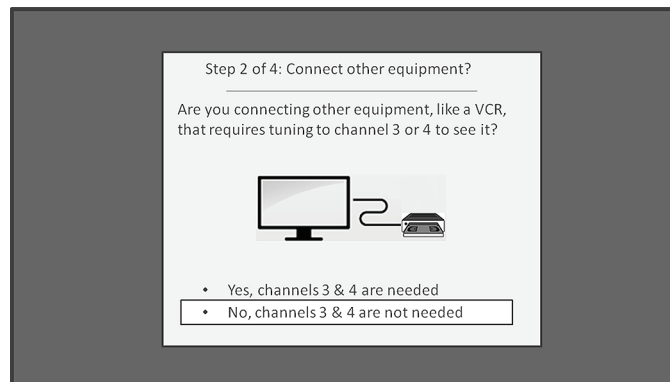

6 Wait while your TV scans for broadcast (antenna TV) stations...



... and then cable TV channels.



Tip

Cable TV channels are channels from a cable TV provider that you can receive by connecting their cable directly to your TV (unscrambled NTSC, ATSC, and QAM channels, if you're the kind of person who is interested in the details). In many cases, your cable provider probably requires you to use their set-top box and connect it to a different input, and then use the set-top box to tune your cable stations. In that case, you can skip scanning for cable channels.

7 When the channel scans finish, your TV shows the number of channels it added.



Scanning for channels can take several minutes.

Tip

Repeat the channel scan from time to time to make sure you are receiving all of the latest channels. Broadcasters add and remove channels, move channels to different parts of the spectrum, and change the power levels of their channels periodically.

Note

You'll have to repeat the channel scan if you remove the **Antenna TV** tile from the **Home** screen or perform a factory reset. To repeat the channel scan at any time, go to **Settings > TV inputs > Antenna TV > Scan again for channels**. Your antenna reception and picture quality depend on the position of your antenna and on your location relative to the antennas of broadcasters in your area.

Now, you're ready to watch broadcast TV! While you're watching, try the following:

- Press the **UP** and **DOWN** arrows to change channels.
- Press the **RIGHT** arrow to display the channel list and then use the **UP** and **DOWN** arrows to select a channel to watch. Or press **REWIND** or **FAST FORWARD** to jump through the channel list a page at a time.
- Press **OK** to display information about the current program.
- Press ↶ to switch to the previously tuned channel.
- Press * to see options for picture and sound settings.

Note

If ↶ is not available on your remote control, you can use ↶ on the Roku App or the Jump Back button on a universal remote. For more information, see [Other devices](#) on page 69.

[Remote control](#) on page 12 has more information on using the remote control buttons while watching TV.

Using your TV

This section provides information on using the day-to-day features of your TV.

Status light

Your TV has a single status light on the front panel. It goes on and off and blinks in different ways depending on the status of the TV, as shown in the following table:

TV condition	Status indicator	Meaning
On (screen is active)	Off	Screen is indicating that your TV is on.
Screensaver (screen is active, except when the Picture Mode is set to Power Saver . Power Saver turns off the backlight.)	Off	Screen is indicating that your TV is on.
Off (no power)	Off	Your TV is not connected to power.
Off (standby)	On	Your TV is connected to power and ready to use.
Starting up from off state	Slow pulsing blink until startup completes	Your TV is doing something.
On (receiving update from USB)	Slow pulsing blink until update completes	Your TV is doing something.
Remote control command received	Dims on/off once	Your TV has received your command.
Powering down to standby mode	Slow pulsing blink until the TV reaches standby	Your TV is doing something.

Standby mode energy savings

When you turn off your TV, it may remain in a higher power mode for a few minutes, after which it goes into a very low power standby mode. If you turn on the TV again before it has entered the very low power mode, it turns on immediately. After the TV goes into the lower power standby mode, it takes a bit longer to start up.

Watching broadcast TV channels

To watch broadcast TV, select the **Antenna TV** tile in the **Home** screen. Your TV remembers the last channel you watched and starts with that channel playing.

Tip

You also can use the buttons on the TV panel to select Antenna TV, as explained in [Buttons](#) on page 10.

Changing channels

To change channels, you can do any of the following:

- Press the **UP** arrow to change to the next higher channel.
- Press the **DOWN** arrow to change to the next lower channel.
- Press the **LEFT** arrow to display the channel list, and then press the **UP** and **DOWN** arrows to move the highlight through the list one channel at a time. Or press **REWIND** and **FAST FORWARD** to move the highlight through the list one page at a time. When you've highlighted the channel you want to watch, press **OK**. (If you decide you don't want to change channels, press the **RIGHT** arrow or **BACK** button).
- Press ↶ to switch to the previously tuned channel.

Note

If ↶ is not available on your remote control, you can use ↶ on the Roku App or the Jump Back button on a universal remote. For more information, see [Other devices](#) on page 69.

Viewing program information

To view information about the current program, press **OK**. Your TV displays a banner at the bottom of the screen with as much information as is available in the program data stream, as shown in the following example.



Program information, subject to availability within the broadcast information, includes:

- Channel number
- Channel call sign
- Signal strength
- Program title
- Start time, end time, and graph of program length showing current position
- Content rating
- Video resolution (480i, 480p, 720p, 1080i, 1080p)
- Audio quality (Mono Dolby Digital, Stereo Dolby Digital, 5.1 Dolby Digital, Dolby Digital+)
- Audio features (SAP)
- Closed captioning (CC)
- Current time
- Program description. If the entire description does not fit, press **OK** to expand the size of the banner and see the entire description.

Adjusting settings

Press ***** to display the *Options* menu. Press the **UP** and **DOWN** arrows to highlight an option, and then press the **LEFT** and **RIGHT** arrows to change the setting. [Adjusting TV settings](#) on page 49 explains each of the settings in detail.

Switching TV inputs

Switch to a TV input to access the device connected to that input, for example, a Blu-ray player. Switching inputs is as simple as highlighting the input's tile in the **Home** screen, and pressing **OK**. The video signal on the input, if any, appears on the screen.

Tip

You also can use the buttons on the TV panel to select a TV input, as explained in [Buttons](#) on page 10. [Customizing your TV](#) on page 56 explains how to rename and remove inputs.

Auto-detecting devices

Your TV automatically detects when you connect a new device to an HDMI input and turn on its power. The input is automatically added to the **Home** screen if it isn't already present.

Adjusting audio/video settings

While watching video content on any input, press ***** to display the *Options* menu. Press the **UP** and **DOWN** arrows to highlight an option, and then press the **LEFT** and **RIGHT** arrows to change the setting. [Adjusting TV settings](#) on page 49 explains each of the settings in detail.

Playing content from USB storage devices

Your TV has a USB port that can be used to play personal music, video, and photo files from a personal USB flash drive or hard disk. If your TV is connected to the Internet, your **Home** screen has the **Roku Media Player** tile. If your TV has not been connected to the Internet, the **Home** screen has the **USB Media Player** tile.

To use this feature, first make sure your media files are compatible with the Roku/USB Media Player. As of the publication date of this guide, the following media file formats are supported:

- Video—MKV (H.264/262), MP4, MOV (H.264)
- Music—AAC, MP3, WMA, WAV (PCM), AIFF, FLAC, and AC3, and DTS
- Photo—JPG, PNG (up to 4k x 4k pixels)

To see the latest list of supported formats, view **Help** in the Media Player.

Notes

- The Roku/USB Media Player displays supported file types only, and hides file types it knows it cannot play.
- There are many variants of each of these media formats. Some variants may not play at all or may have issues or inconsistencies during playback.
- DTS audio, whether in music or video files, is supported only by pass-through, meaning that your TV cannot directly output the sound of a DTS file, but can pass it through to a DTS-compatible receiver that is connected to the **HDMI1 (ARC)** or **SPDIF** connector on your TV.

Playing content from local network media servers

If you have connected your TV to a network, it can play personal video, music, and photo files from a media server on your local network. Media servers include personal computers running media server software such as Plex or Windows Media Player, network file storage systems that have built-in media server software, and other devices that implement the specifications of the Digital Living Network Alliance. Some servers do not fully implement the DLNA specification but are UPNP (Universal Plug and Play) compatible. The Roku Media Player will connect to them as well.

Some media servers can convert files into Roku compatible formats. DRM-protected content is not supported.

Using your TV in a hotel or dorm room

Hotels, school dorms, conference facilities, and similar locations with public wireless Internet access often require you to interact with a web page to authenticate your access. These restricted public networks are commonly known as captive portal networks. When you select a network of this type, the TV automatically detects that additional information is needed and prompts you through using another wireless device to supply the requested information.

Tips

- Using your Roku TV on a hotel or dorm room network requires wireless availability and use of your network-connected smartphone, tablet, or computer to authenticate access to your account.
- Your TV must already be running software version 7.0. You can find the version number by navigating from the Home screen to **Settings > System > About**. If it is running an earlier software version, you must use a non-restricted wireless network to link and activate the TV, and then update the software to version 7.0.
- Be sure to bring your Roku TV remote control, because the Remote feature of the Roku mobile app may not work when connected to a hotel or dorm room network.
- Content might be limited or unavailable if you try to connect outside your home country due to geo-filtering.

To connect your TV to the restricted network:

- 1 Either during Guided Setup or after selecting **Settings > Network > Set up new Wi-Fi connection**, you're presented with a list of available networks.

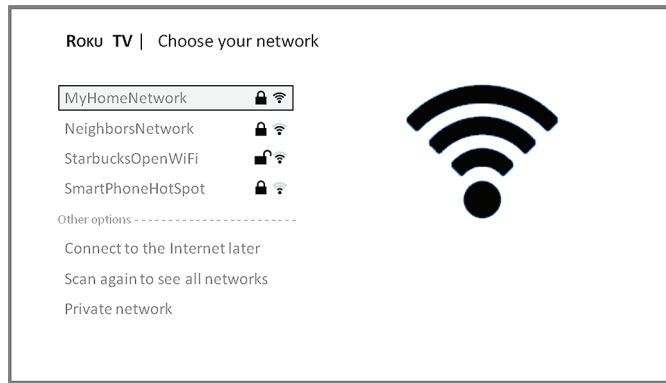

- 2 If you select a network that requires interaction to grant access to the Internet, the TV detects that additional information is needed and displays the following prompt.

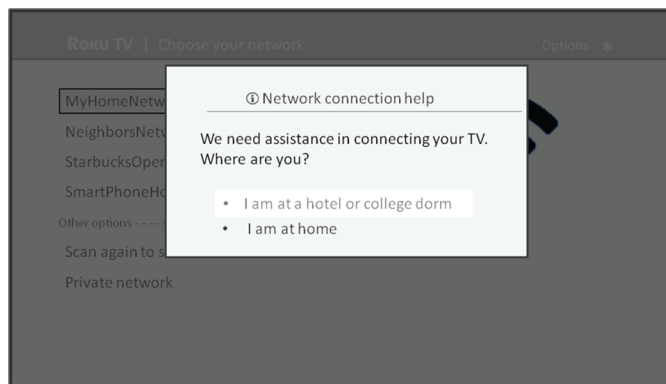

Tip
Your TV can connect to a restricted network only if **Device connect** is enabled in **Settings > System > Advanced system settings**. (**Device connect** is enabled by default, but if you have disabled it, the TV cannot complete the connection.)

Note
Device connect is not present if the TV is in non-connected mode.

- 3 If you selected the correct network, highlight **I am at a hotel or college dorm**, and then press **OK**. The TV prompts you to use your smartphone, tablet, or laptop to complete the connection.

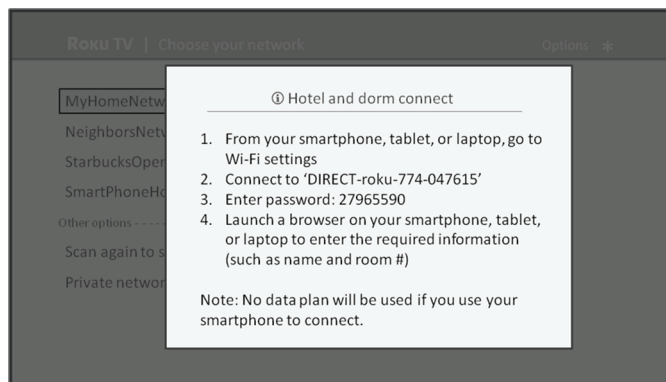

- 4 Use a phone, tablet, or wireless-enabled computer to detect wireless networks. In most cases, you can simply open the device's Wi-Fi Settings or Network Settings screen to start scanning.

Note

The phone, tablet, or computer must be on the same wireless network to which you are connecting the TV.

- 5 Connect to the network named on your TV screen. The actual network name varies.

Note

The previous step connects your smartphone, tablet, or computer directly to the TV. No connection charges apply and the connection does not impact your device's data plan.

- 6 The wireless connection process prompts you for a password. Enter the password as shown on the TV screen. The actual password varies.
- 7 Start the web browser on your smartphone, tablet, or computer. When you attempt to open any web page, the restricted connection will prompt you for whatever information it needs. In most cases, you must agree to terms and conditions, provide identifying information, or enter a password, PIN, or room number to proceed. The information requested depends on the organization that controls the wireless connection.
- 8 After you enter the requested information, the TV automatically proceeds to complete its connection and resumes normal operation.
- 9 If the TV prompts you to link to your Roku account, use your smartphone, tablet, or computer to complete the pairing operation and activate your Roku TV.

Adjusting TV settings

You can adjust most picture and sound settings while you are watching a program by pressing ***** to display the *Options* menu. If you don't find what you need, there are additional picture and sound settings in the *Settings* menu.

In most cases, the changes you make apply only to the input you are using. Antenna TV, each separate HDMI input, and the AV input have their own settings that your TV remembers when you return to that input. Your TV also remembers the settings you specify while viewing streaming content.

Settings menu

Use the *Settings* menu to adjust overall TV settings. Press  to go to the **Home** screen, and then navigate to **Settings>TV picture settings**.

You can adjust the following overall TV picture settings from the *Settings* screen:

- **TV brightness**—If the lighting level in your TV room changes, use this setting to help provide a better viewing experience; set to darker for a darker room, and brighter for a brighter room. Choose among **Normal** and four other settings to make the overall picture brighter or darker. So that you don't have to make this type of change for each TV input one at a time, this setting increases or decreases your TV's general brightness across all TV inputs. This setting is identical to the TV brightness setting you can access in the *Options* menu while watching a program.
- **Settings per input**—This section of options lists each TV input. Select an input to switch to that input. Then press ***** to display the *Options* menu, where you can adjust the input's settings while watching a live picture and listening to the sound from that input.

Tip

You don't have to go to the *Settings* menu first—you can display an input's *Options* menu and adjust its settings whenever you are watching the input by pressing *****.

Options menu

The *Options* menu for each TV input provides settings for controlling the appearance of the picture and the quality of the audio.

To view the *Options* menu, press ***** whenever you are watching a TV input or streaming a video. The *Options* menu is a panel that appears over the left side of the screen:

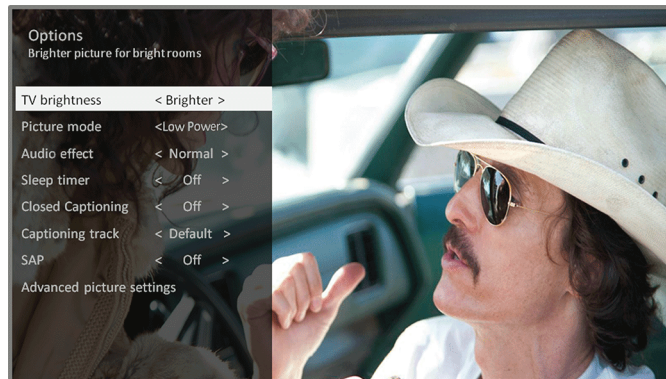

To adjust the settings on the *Options* menu, press the **UP** or **DOWN** arrow to highlight a setting, and then press the **LEFT** or **RIGHT** arrow to change the setting. You'll notice the changes you make right away in picture appearance or audio quality.

Tip

When you highlight a setting, the header text explains the effect of its current value. When you begin to adjust a setting, the other options are hidden so you can see more of the screen. Even though the other settings are hidden, you can move the highlight up or down to adjust the other settings.

Options menu settings



- **TV brightness**—Affects the overall brightness of the picture. This setting applies across your entire TV; that is, to all TV inputs and is identical to the **TV brightness** setting under **Settings > TV picture settings**.
- **Picture mode**—Provides picture presets for various viewing preferences. This setting applies to the currently-selected input only.

Note

The **Low power** option reduces the amount of power your TV consumes. For more information about picture modes, see [Advanced picture settings menu options](#) on page 51.

- **Audio effect**—Adjusts the sound quality output from the your TV speakers. This setting applies across your entire TV; that is, to all TV inputs. It does not affect the sound quality for headphones, **HDMI1 (ARC)**, or **SPDIF (TOSLINK)** connectors.
- **Sleep timer**—Sets a timer that turns off your TV after the specific amount of time. This setting remains in effect even if you stop watching the current input.
- **Closed captioning**—Controls when you see captions. This setting is only offered for Antenna TV, the AV input, and streaming videos. Any set value remains in effect across only these inputs.
 - **Antenna TV**—Turn captions on or off, or set them to appear only when your TV sound is muted.
 - **AV input**—Turn captions on or off, or set them to appear only when your TV sound is muted.
 - **Streaming video channel**—Turn captions on or off, set them to appear only when your TV sound is muted, or only during instant replay (for streaming content that supports instant replay).

Tip

If the Instant Replay  button is not available on your remote control, you can use  on the Roku App or the Jump Back button on a universal remote. For more information, see [Other devices](#) on page 69. Additional captioning options are provided in the *Captions* screen in **Settings**.

- **Captioning track**—Selects which caption track to display when Closed Captioning is on. This setting remains in effect on all inputs that provide captions.
- **SAP**—Selects whether to play a secondary audio program or multichannel television sound, and which choice to play. This setting applies only to Antenna TV on digital channels.

Tip

To dismiss the *Options* menu, just wait a few seconds without pressing any buttons. Or press ***** again to dismiss the menu immediately.

Advanced picture settings

The *Advanced picture settings* menu for each TV input provides settings for fine tuning the appearance of the picture. All of the settings in this menu apply only to the currently-selected input.

To use the *Advanced picture settings menu*, first press ***** to display the *Options* menu. Then select **Advanced picture settings**.

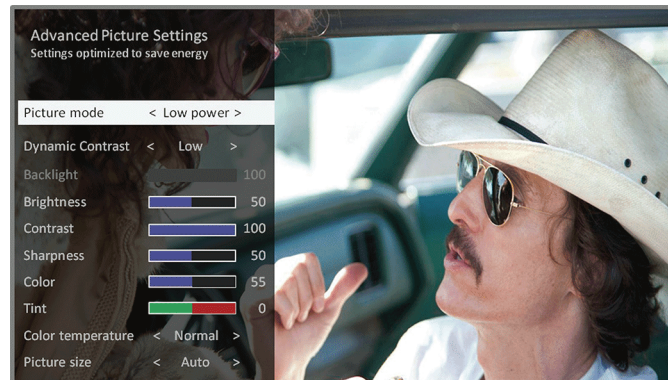

To adjust the settings on the *Advanced picture settings* menu, press the **UP** or **DOWN** arrow to highlight a setting, and then press the **LEFT** or **RIGHT** arrow to change the setting. You'll notice the changes you make right away in picture appearance.

Tip

When you highlight a setting, the header text explains the effect of its current value. When you begin to adjust a setting, the other options are hidden so you can see more of the screen. Even though the other settings are hidden, you can move the highlight up or down to adjust the other settings. As soon as you press the **UP** or **DOWN** arrow, the other settings become visible again.

Advanced picture settings menu options

- **Picture mode**—Provides picture presets for various viewing preferences. This setting duplicates the one on the *Options* menu. When you change the **Picture mode**, other picture settings adjust accordingly. For example, setting the **Picture mode** to **Vivid** sets **Brightness**, **Contrast**, **Sharpness**, and other values to produce a very vibrant picture. Setting **Picture mode** to **Movie** changes these same settings to produce a picture suitable for enjoying movies in a darkened room. If you make changes to the individual picture settings—for example, **Contrast** or **Sharpness**—these settings are saved for the current input *and* the current picture mode. In this way, the HDMI 1 input's **Movie** picture mode can be customized and different than the HDMI 2 input's **Movie** picture mode and Antenna TV's **Movie** picture mode. **Low power** is a power-saving picture mode that reduces power consumption. When you use **Low power**, you'll notice that your TV's picture is a little dimmer than the brightest picture modes (**Vivid** and **Normal**). Use **Reset picture settings**, described below, to return the input's current picture mode to its original values.
- **Dynamic Contrast**—Automatically adjusts the backlight level to achieve the optimum contrast and prevent excessive differences between light and dark areas of the screen. The **Backlight** option is disabled when **Dynamic Contrast** is enabled.
- **Backlight**—Adjusts the overall light intensity of the screen.
- **Brightness**—Adjusts the dark level of the black areas of the picture.
- **Contrast**—Adjusts the white level of the light areas of the picture.
- **Sharpness**—Adjusts the sharpness of the edges of objects in the picture.
- **Color**—Adjusts the intensity of colors in the picture. A setting of 0 removes all color and displays a black and white picture.
- **Tint**—Adjusts the color balance from green to red to obtain accurate colors in the picture.
- **Color temperature**—Adjusts the overall colors in the picture from **Normal** to slightly more bluish (**Cool**) to slightly more reddish (**Warm**).

- **Picture size**—Adjusts the aspect ratio of the picture, enabling you to view a picture in its original format, or zoom or stretch it to fill the screen. The **Auto** setting has been found to produce the best picture in most cases.
- **Game mode**—Controls whether Game mode is on or off. When **On**, your TV performs less image processing and has less input lag. When **Off**, your TV may perform more image processing and has more input lag, which is less desirable for action games. *Available only for HDMI and AV inputs.*
- **Reset picture settings**—Returns all picture settings for the input's currently-selected **Picture mode** to their original values.

Tip

To dismiss the *Advanced picture settings* menu, just wait a few seconds without pressing any buttons. Or press ***** again to dismiss the menu immediately.

Changing privacy settings

By default, when connected to the Internet and activated with your Roku account, the TV uses an advertising identifier to track your usage behavior. You can change the privacy settings on your TV in two ways: resetting the advertising identifier and limiting ad tracking.

Note

Privacy settings are not present on TVs operating in non-connected mode. Non-connected TVs do not display advertisements.

Resetting the advertising identifier

Resetting the advertising identifier has the effect of clearing your prior usage history and starting over. From that point forward, your new usage patterns affect the advertisements you see on your TV.

To reset the advertising identifier:

- 1 From the **Home** screen menu, navigate to **Settings > System > Privacy**.
- 2 Highlight **Reset advertising identifier**. Press ***** to view more information about this option. When you finishing reading the information, press **OK** to close the *More Information* window.
- 3 Press **OK** to reset the advertising identifier, and then press **OK** again to dismiss the verification message.

Limiting ad tracking

You can limit Roku's tracking of your usage behavior by limiting ad tracking. When you do, your TV will display ads that are not personalized based on your TV's advertising identifier.

To limit ad tracking:

- 1 From the **Home** screen menu, navigate to **Settings > System > Privacy**.
- 2 Highlight **Limit ad tracking**. Press ***** to view more information about this option. When you finish reading the information, press **OK** to close the *More Information* window.
- 3 Press **OK** to select the **Limit ad tracking** option.

Note

If you perform a factory reset and then reconnect your TV, ad tracking is restored until you repeat these steps.

My Feed

Use My Feed to find out when you can watch movies coming soon, and to get updates on movies, TV shows, and actors that you are following.

Movies Coming Soon

My Feed gives you updates on your list of movies that are coming soon to theaters. With My Feed, you'll know when your favorite movie is ready to stream, the channels it is on, and how much it will cost.

Select the movies you want to follow by going to **My Feed > Movies Coming Soon**. You'll then see a list of newly released movies that are not yet available for streaming. Select a movie, and then select **Follow this movie on Roku**. When you return to the main **My Feed** screen, you'll see banners for each of your newly-followed movies along with banners for movies and TV shows you're already following.

Movies, TV shows, and people

In addition to following movies coming soon, you can follow any movie, TV show, or actor. To do this, use the Search feature to find the movie, TV show, or name that you want to follow, and then select Follow this movie/TV show/person on Roku. For more information, see [Searching for something to watch](#) on page 53.

Note

The TV takes a bit of time to update your newly-followed shows. Until it finds at least one channel offering the movie, the content banner in My Feed shows **Check back later for updates**.

My Feed alerts you any time a movie or TV show you are following becomes available on another channel and whenever its price changes. A number in parentheses next to **My Feed** in the **Home** menu means that My Feed has updated information that you haven't viewed yet. For example, you if three of your followed shows have updates, you'll see **My Feed (3)**.

Note

When a movie or TV show you are following becomes available, the streaming channel offering the movie might require that you subscribe or pay a fee to view it.

Tip

My Feed is available only if your TV is connected to the Internet.

Searching for something to watch

Searching for movies and shows across multiple streaming channels is one of the unique features of your TV. Within a single search operation, you can search by:

- Movie name
- TV show name
- Actor or director name
- Streaming channel name
- Game name

Tip

Roku Search is available only if your TV is connected to the Internet.

Note

Roku Search doesn't search across all streaming channels, but searches across lots of popular streaming channels. The actual channels it searches vary by locale, but include popular providers such as Netflix and several others, with more being added all the time.

You can check which streaming channels are included in Roku Search by going to the *Search* screen, clearing all previous searches to reveal the search instructions, and then watching the channel tiles cycle at the bottom of the screen. To search, select **Search** on the **Home** screen menu. The *Search* screen has a keyboard grid and initially displays instructions—a set of icons representing search categories and a list of participating provider tiles.

Tip

If you don't see the instructions, navigate to the end of the list of recent searches and select **Clear recent search selections**.

How do I search?

To search, use the arrow buttons to navigate the on-screen keyboard, entering a few characters of the search term. With each additional character you enter, you narrow down the search and the search results become more relevant.

Tip

Use the free Roku mobile app on your compatible smartphone or tablet to make searching even faster. Not only can you use your device's keypad to type, you can search simply by touching a voice search icon and saying the name of the movie, TV show, actor or director, channel, or game.

An icon next to each search result shows the category of the result (movie, TV show, actor).

- Press the **RIGHT** arrow to highlight the search results.
- Press the **UP** and **DOWN** arrows to scroll through the list of search results to highlight the item you want to view.

I found a show, now what?

Now that you've highlighted the show, movie, actor, game, or streaming channel you were looking for, press the **RIGHT** arrow. If your search result was an actor, director, or other item that does not represent a single item of content, you'll see another list to narrow down your search. Continue highlighting results and pressing the **RIGHT** arrow until you find a single, viewable content item.

An **HD** logo means that the content is available in high-definition. The checked circle adjacent to the title means you have already added the streaming channels.

When you narrow down your search to a game or streaming channel, you'll see detailed information, images, and available actions such as a list of streaming channels and the cost of getting the item on each channel.

Note

Some channels may require a subscription.

Following on Roku

Rather than watch the show you found in Search, you can add it to My Feed and wait until it's available on a particular streaming channel or available at a better price. From the search results screen, select Follow on Roku. Then go to My Feed periodically to check for updates to each of your followed movies, TV shows, or people. For more information, see [My Feed](#) on page 53.

Recent Searches

The next time you use Roku Search, the *Search* screen displays a list of recent search selections in place of the search instructions.

Using the recent search selections list makes it easy to quickly get to a previously found item, for example, to find another movie with the same actor, or another TV show in the same series.

Using the Roku Channel Store

The **Streaming Channels** menu option takes you to the Roku Channel store, where you can add new streaming channels to your TV.

Tips

- The **Streaming Channels** menu option is available only if your TV is connected to the Internet.
- You also can search for streaming channels by using the **Search** option, as explained in [Searching for something to watch](#) on page 53.

To make it easier to find what you want, the streaming channels in the Roku Channel Store are categorized by topic. Press the **UP** and **DOWN** arrows to highlight the category you want, and then press the **RIGHT** arrow to move the highlight into the grid of streaming channel tiles.

When you find a streaming channel you want to add or learn more about, highlight it and press **OK** to display more details.

- If the streaming channel you are adding is free, you can select **Go to channel** to start watching it immediately.
- If there is a one-time or recurring fee associated with using the streaming channel, you must agree to the terms and conditions, accept the fee, and—if you created one when you activated your TV, enter your Roku PIN code to authorize the charges.
- If you already have a subscription to the streaming channel—for example, you already subscribe to Netflix or you receive HBO through your cable TV provider—you must complete a different, simple authorization step to add the streaming channel.

You only have to complete the authorization or activation step one time, when you initially add the streaming channel. After that, you simply select the streaming channel tile from your **Home** screen to start watching. (Channel and content availability is subject to change. Charges may apply to your selection.)

Tip

New streaming channels are added continuously, so be sure to check back every now and then.

Note

If you don't remember your PIN, or if want to change whether you need to use a PIN to make purchases on your Roku account, see [Changing your Roku Channel Store PIN preference](#) on page 67.

SHARP • Roku TV

Customizing your TV

LC-43LB371U/LC-50LB371U 43"/50" 1080p, 60Hz, LED Sharp Roku TV

There are several things you can do to personalize your TV.

Rearrange tiles

Whenever you add a TV input tile, it's added at the top of your **Home** screen. Whenever you add a new streaming channel from the Roku Channel Store, it's added at the bottom of your **Home** screen.

You can easily rearrange the order of the tiles on the **Home** screen to suit your viewing preferences. For example, you might want **Antenna TV** to be the first tile in your **Home** screen. But if you mostly watch one streaming channel, you might want its tile to be the first one on your **Home** screen.

Rearranging tiles is easy:

- 1 From the **Home** screen, highlight one of the tiles you want to move.
- 2 Press ***** to display a list of options for the type of tile you selected.
- 3 Select **Move input**. The list of options disappears and the highlighted tile shows arrows indicating how it can be moved.

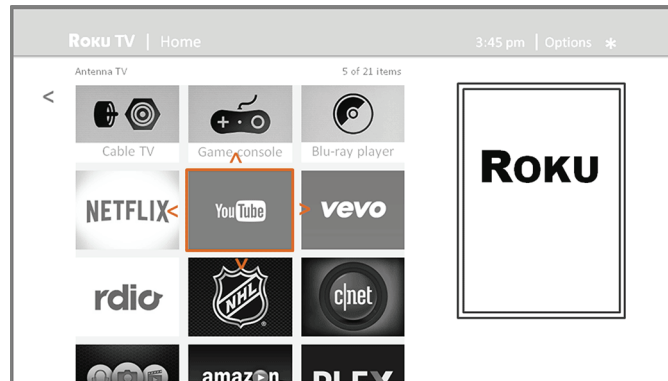

- 4 Use the arrow buttons to move the highlighted tile to its new position. As you move the tile, it pushes other tiles out of its way.
- 5 Press **OK** to lock the tile into its new position.
- 6 Repeat these steps to move other tiles until you have arranged your **Home** screen to your liking.

Edit broadcast TV channel lineup

When you set up the TV tuner as described in [Setting up Antenna TV](#) on page 41, your TV adds all the channels with good signals that it could detect in your area. It's likely that you now have more channels than you want in your channel list. To edit the channel lineup, from the **Home** screen, navigate to **Settings>TV inputs >Antenna TV>Edit channel lineup**. You'll see a screen listing all of your channels. Adjacent to the list of channels is a miniature TV screen playing the highlighted channel's picture and sound.

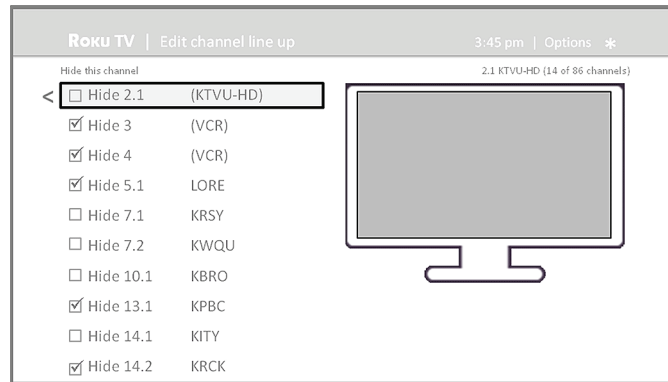

Highlight each channel you want to hide, and then press **OK** to hide the channel.

Tip

If you need to see or hear the highlighted channel, wait a couple of seconds for your TV to start playing the channel's picture and sound. Also note that if you've enabled parental controls and the program on the current channel is blocked, you won't see a picture or hear sound while editing the channel lineup.

Rename inputs

Rather than trying to remember that your Blu-ray player is connected to HDMI 1 and your game console is connected to HDMI 3, you can rename the TV inputs to match the connected component.

Tip

Renaming an input also changes the icon associated with it.

To rename an input, you can either:

- Highlight the input tile in the **Home** screen, and then press ***** to display a list of options. From the list of options, select **Rename input**. Then select a new name and icon.

or

- From the **Home** screen, navigate to **Settings>TV inputs**. On the *TV inputs* screen, select the input you want to rename, select **Rename**, and then choose a new name and icon from the provided list.

Press **⏪** to return to the **Home** screen. The new name and icon are now in effect.

Remove unwanted tiles

It's easy to remove unused TV inputs and unwanted channel or app tiles. For example, if you never use the HDMI 3 input, or if you don't like the weather app you added from the Roku Channel Store, you can remove them from your **Home** screen.

Tip

You also can remove the **Antenna TV** tile if you never use the TV tuner. But be aware that removing the **Antenna TV** tile also deletes the broadcast TV channel list. You'll have to set up the TV tuner again next time you want to view broadcast TV. Instructions for setting up the TV tuner can be found in [Setting up Antenna TV](#) on page 41.

- To remove any tile, highlight the input tile in the **Home** screen, and then press ***** to display a list of options. From the list of options, select **Remove input**. In the screen that follows, confirm you want to remove the input.
- Alternatively, to remove a TV input tile from the **Home** screen, navigate to **Settings > TV inputs**. On the *TV inputs* screen, select the input you want to remove, and then select **Remove > Confirm**. Then press **⏪** to return to the **Home** screen.

Change themes

Another way to customize your TV is to change its theme. The theme establishes the look and feel of your TV through colors, designs, and fonts.

Tip

Themes are available only when your TV is connected to the Internet. Some themes require payment.

To change the theme, in the **Home** screen menu navigate to **Settings>Themes**. In the *Themes* screen, choose from the following options:

- **My themes**—Highlight a theme, and then press **OK** to switch to that theme.
- **Custom settings**—Turn **Featured themes** on or off. When **Featured themes** is on, your TV automatically switches to featured themes—like certain holiday-inspired themes—for a limited time whenever Roku makes them available, and then switches back to your selected theme when the featured theme expires. When off, your TV always uses your selected theme.

Change the screensaver

Displaying a still image (such as a logo) for an extended period of time can cause a permanent after-image to be burned into the screen. To avoid after-image burn-in, your TV turns on a screen saver after it is idle for a few minutes. To change the screensaver, in the Home screen menu navigate to **Settings>Screensaver**, and then select a screensaver.

Tip

The **Power Saver** screensaver reduces the amount of power your TV uses by turning off the backlight. For example, if the **Picture mode** is set to **Vivid** or **Normal**, **Power Saver** reduces power consumption.

Change sound effects volume

Sound effects are the noises your TV makes to let you know it received your command. You can change the volume of sound effects or turn them off.

To adjust the sound effects volume, in the **Home** screen menu, navigate to **Audio>Menu volume**. Navigate to the right and then change the setting to **High**, **Medium**, **Low**, or **Off**.

Configure power settings

Power settings let you set up your TV so that it turns on to the location you choose. Power settings also help your TV save energy by automatically turning it off under certain conditions.

Power on settings

Power on settings tell your TV what to do when you turn on the power. To configure the power on settings, from the **Home** screen menu, navigate to **Settings > System > Power > Power on**. Highlight the power on location from the list, and then press **OK** to select it.

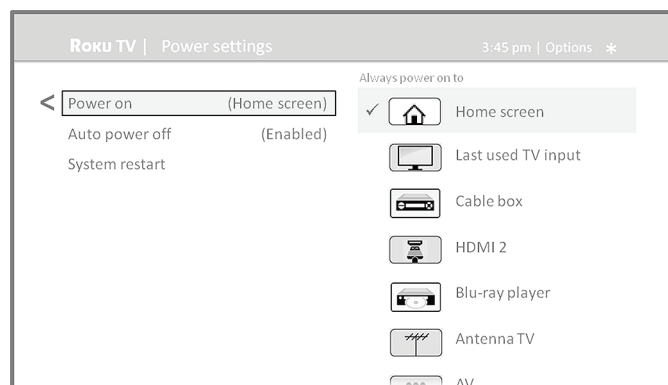

Auto power off settings

To help you save energy, your TV can automatically turn itself off after a period of inactivity or a period during which no signal has been detected. It is factory-configured to do both of these things, but you can change these settings if needed.

To configure automatic power off, from the **Home** screen menu navigate to **Settings > System > Power > Auto power off**. In the *Power settings* screen, highlight the following options and press **OK** to turn them on or off:

- **After 15 minutes of no signal**—If no signal is detected on a TV input for 15 minutes, your TV automatically powers off.
- **After 4 hours of no interaction**—If no remote control or panel button is pressed for 4 hours and your TV is not displaying a TV signal or streaming a video, your TV is automatically powered off.

Configure parental controls

Parental controls enable you to control whether the members of your household can view certain kinds of broadcast TV programs. When a program or feature is blocked, you can unblock it by entering a parental control PIN that only you know.

Note

The parental control feature can be used to hide the **Movie Store**, **TV Store**, and **News** options that are available on the **Home** screen menu of TVs manufactured for the United States. However, the parental controls feature does not block other streaming content nor content from inputs other than the TV tuner.

Creating a parental control PIN

The first time you access the *Parental controls* screen, you must create a new parental control PIN. Thereafter, whenever you want to change parental control settings, unblock programming that has been blocked, change the PIN, or disable parental controls, you must enter your parental control PIN.

Tip

Your parental control parental control PIN has nothing to do with your Roku PIN. You can make them the same if you want—this is entirely your choice.

To create a new parental control PIN, from the **Home** screen menu navigate to **Settings > Parental controls**. The screen displays a numeric keypad. Use the arrow buttons and the **OK** button to enter a four digit code. Then repeat the process to enter the same PIN again, just to make sure you correctly entered the PIN you want to use.

Important

If you forget your PIN, the only way to recover is to perform a factory reset operation, as explained in [Factory reset everything](#) on page 67. Be sure to write it down in a safe place just in case.

Blocking Movie Store, TV Store, and News (US TV models only)

One of the parental control options is to completely hide the entertainment options that are available directly on the **Home** screen menu of TVs manufactured for sale in the United States. (The Movie Store, TV Store, and News options are not available on TVs manufactured for sale in Canada).

To hide Home screen entertainment options:

- 1 From the **Home** screen menu, navigate to **Settings > Parental controls**, and then enter your parental control PIN.
- 2 In the *Parental controls* screen, highlight **Home screen** and then select or clear either of these options:
 - **Hide "Movie Store and TV Store"**—Removes the **Movie Store** and **TV Store** options from the **Home** screen menu.
 - **Hide "News"**—Removes the **News** option from the **Home** screen menu.

Tip

To use either of these options after you've hidden them, you must return to this screen and remove the check mark from the corresponding **Hide** command.

Blocking Broadcast TV shows

For broadcast TV, parental controls use information embedded in the broadcast signal to determine whether to allow a program to be displayed. Parents can configure parental controls to block broadcast TV programs that meet or exceed a specific rating, so they cannot be viewed or heard unless the correct parental control PIN is entered.

Note

Rating standards differ by country.

Enabling parental control of TV shows

The first step in blocking TV shows is to enable parental control of TV shows.

This setting is provided separately to make it easier for you to turn parental control of TV shows on and off without disturbing their settings. For example, your kids are going to summer camp for two weeks, and while they are gone, you don't want to have to deal with unblocking shows that you want to watch by entering your parental control PIN. All you need to do is clear **Enable parental controls**, and all TV shows are unblocked. When the kids return, select **Enable parental controls** again, and all of your parental control settings are restored in a single operation.

To enable parental control of TV shows:

- 1 In the **Home** screen menu, navigate to **Settings > Parental controls**, and then enter your parental control PIN.
- 2 In the *Parental controls* screen, navigate to **TV tuner > Parental control of TV shows**.
- 3 Make sure the check box next to **Enable parental controls** is checked. If not, highlight it and press **OK**.

Blocking based on US TV ratings

Most broadcast US TV shows—other than movies—contain rating data that enables parental controls to block shows that parents don't want others to view. The ratings are divided into two groups that function independently:

- **Youth group**—TV-Y, TV-Y7
- **Main group**—TV-G, TV-PG, TV-14, TV-MA

Within each of these groups, the ratings interact such that if you block a particular level of content, your TV also blocks all content with a higher rating. Conversely, if you unblock a particular level of content, your TV also unblocks all content with a lower rating. For example, if you block TV-PG programs, your TV also blocks TV-14 and TV-MA programs. If you subsequently unblock TV-14 programs, TV-PG programs are also unblocked, but TV-MA programs remain blocked.

Similarly, within the main group, content types can be individually blocked. For example, you can block just coarse language in shows with a TV-PG rating. If you do, then your TV also blocks shows with coarse language in the higher ratings (TV-14 and TV-MA). Subsequently unblocking coarse language in TV-14 ratings does not unblock coarse language in TV-MA programs, but it does unblock coarse language in TV-PG programs.

To block TV shows based on US television ratings:

- 1 From the **Home** screen menu, navigate to **Settings > Parental controls**, and then enter your parental control PIN.
- 2 In the *Parental controls* screen, navigate to **TV tuner > TV ratings**. Choose among the following settings:
 - **Entire ratings**—Highlight the rating you want to block, and then navigate to the right and select the first option that blocks the entire rating level (and all higher rating levels).
 - **Individual content types**—Highlight the rating that contains the content type you want to block, and then select the content types you want to block from among those listed. Remember that blocking a content type in one rating blocks the equivalent content type in all higher rating levels.

Blocking based on US movie ratings

Most movies in the US are rated by the Motion Picture Association of America, or MPAA, so the ratings are known as MPAA ratings. TV broadcast signals carry movie rating data that enables parental controls to block shows that parents don't want others to see. The ratings are:

- G—General audiences
- PG—Parental guidance suggested
- PG-13—Parents strongly cautioned for children age 13 or younger
- R—Restricted
- NC-17—Not for age 17 or younger

Unlike US TV ratings, there are no individual content types within the ratings. But like TV ratings, blocking movies with a particular rating also blocks movies with a higher rating, and unblocking movies with a particular rating also unblocks movies with a lower rating.

Tip

Blocking movies with an NC-17 rating also blocks programs with the now-obsolete X rating, which can still occur in the program data of older movies.

To block movies based on MPAA ratings:

- 1 From the **Home** screen menu, navigate to **Settings > Parental controls**, and then enter your parental control PIN.
- 2 In the *Parental controls* screen, navigate to **TV Tuner > Movie ratings**.
- 3 Select the rating level you want to block. You need only select one rating level, and all higher levels are automatically blocked.

Blocking based on Other ratings

Your TV can block programs having ratings that had not been defined when your TV was manufactured. It does this by detecting a new Rating Region Table in a program and then downloading the new table and displaying its rating in the Parental controls.

When your TV downloads a new Rating Region Table, it adds a new option to the list of rating types: **Other ratings**. If you see this option in the *Parental controls* screen, you have tuned to a station that has implemented a new rating table. Once the new rating table has been downloaded to your TV, it remains in your TV until it is factory reset, and you can configure blocking based on the new ratings.

New Region Rating Tables can have independent rating levels, or rating levels that interact in the same ways as the built-in US TV and MPAA Movie ratings.

Tip

If your TV downloads a new Region Rating Table, you'll have to experiment with its settings to understand how to use it.

Blocking based on Canadian English ratings

Canadian-English language and third-language programs that are broadcast in Canada are rated by the Action Group on Violence on Television, or AGVOT. TV broadcast signals carry rating data that enables parental controls to block shows that parents don't want others to view based on content containing violence, language, sex, or nudity. The ratings are:

- C—Children under 8 years
- C8—Children 8 years and older
- G—Generally suitable for all age groups
- G—Parental guidance suggested for viewers under 14 years
- 14+—Generally not suitable for viewers under 14 years
- 18+—Generally not suitable for viewers under 18 years

Blocking content with a particular rating also blocks content with a higher rating, and unblocking content with a particular rating also unblocks movies with a lower rating.

To block programs based on AGVOT ratings:

- 1 From the **Home** screen menu, navigate to **Settings > Parental controls**, and then enter your parental control PIN.
- 2 In the *Parental controls* screen, navigate to **TV tuner>Canadian English ratings**.
- 3 Select the rating level you want to block. You need only select one rating level, and all higher levels are automatically blocked.

Blocking based on Canadian French ratings

Canadian-French language programs that are broadcast in Canada are rated by the Régie du cinéma du Québec. TV broadcast signals carry rating data that enables parental controls to block shows that parents don't want others to view based on content containing violence, language, sex, or nudity. The ratings are:

- G - Generally suitable for all age groups
- 8+—Viewers 8 years and older
- 13+—Viewers 13 years and older
- 16+—Viewers 16 years and older
- 18+—Adults only

Blocking content with a particular rating also blocks content with a higher rating, and unblocking content with a particular rating also unblocks movies with a lower rating.

To block programs based on Canadian-French ratings:

- 1 From the **Home** screen menu, navigate to **Settings > Parental controls**, and then enter your parental control PIN.
- 2 In the *Parental controls* screen, navigate to **TV tuner>Canadian French ratings**.
- 3 Select the rating level you want to block. You need only select one rating level, and all higher levels are automatically blocked.

Blocking unrated programs

Some broadcast TV shows and movies are assigned a rating of "Unrated". Whether or not such programs contain content that is objectionable to you cannot be determined. However, you can choose to block such programs.

To block all unrated broadcasts:

- 1 From the **Home** screen menu, navigate to **Settings > Parental controls**, and then enter your parental control PIN.
- 2 In the *Parental controls* screen, navigate to **TV tuner>Block all unrated programs**.
- 3 Highlight **Block** and press **OK**. When blocking is enabled, the adjacent padlock icon changed from unlocked to locked.

Tip

Blocking programs that have been assigned a rating of "Unrated" does not block programs that have no rating assigned to them (for example a broadcast of a local town council meeting). Programs that do not have an assigned rating display **Rating NA** (for "not applicable," meaning a rating is not needed). Programs that have no assigned rating are considered "safe"; therefore, there is no need to block them.

What happens when a TV show is blocked?

After you've set up parental controls, TV shows and movies can be blocked:

- When you change channels and the new channel is playing a program whose rating exceeds your settings.
- When a new show comes on the channel you are watching and its rating exceeds your settings.

When a program is blocked by parental control settings, your TV displays a blocked message:

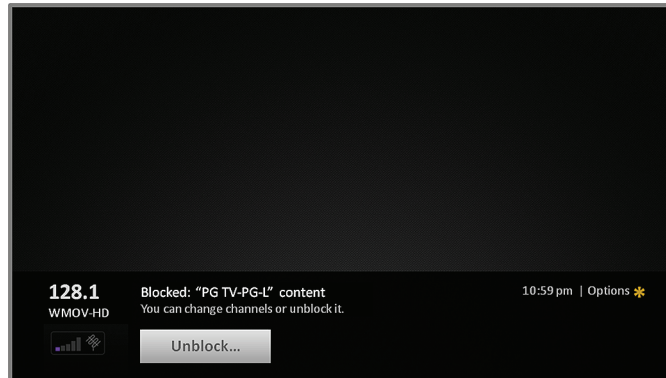

Whenever this blocked message appears, both the video and audio of the show are blocked, as well as program data that would normally appear in the area at the bottom of the screen.

To watch the blocked program, you need to know the PIN code defined when you enabled parental controls, as explained in [Creating a parental control PIN](#) on page 59.

- 1 Press **OK** to select **Unblock** and display a PIN pad.

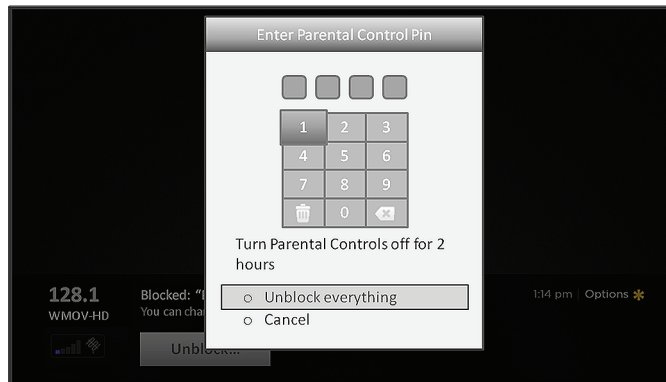

- 2 Use the arrow buttons to enter your parental control PIN code, and then press **OK** to select **Unblock everything**. After unblocking shows that have been blocked, all blocking is disabled for two hours or until you turn off your TV.

*Changing the parental control PIN***To change your parental control PIN:**

- 1 From the **Home** screen menu, navigate to **Settings > Parental controls**, and then enter your parental control PIN.
- 2 In the *Parental controls* screen, highlight **Change PIN**.
- 3 Move the highlight into the adjacent keypad, and then use the arrow buttons and the **OK** button to enter a four digit code. Then repeat the process to enter the same PIN again, just to make sure you correctly entered the PIN you want to use.

Resetting parental controls

So now your kids have grown up and gone away to college, and you no longer want to deal with blocked programs.

To erase all parental control settings:

- 1 From the **Home** screen menu, navigate to **Settings > Parental controls**, and then enter your parental control PIN.
- 2 In the *Parental controls* screen, highlight **Reset parental controls**.
- 3 Follow the instructions on the screen to confirm that you want to erase all parental control settings.

Tip

Resetting parental controls also erases your parental control PIN.

More settings

This section describes the features and settings of your TV that were not covered in the other parts of this guide.

Changing network settings

If needed, you can change your network settings at any time. For example, if you change the name of your wireless network (its SSID) or its password, you will need to change your TV's settings so that it can continue to connect. Also, if you decided not to connect to the Internet in [Guided Setup](#) on page 32, you can use Network settings to connect at a later time.

To change network settings, from the **Home** screen menu, navigate to **Settings > Network**, and then press the **RIGHT** arrow. At this point, you can choose the following options:

- **Update connection**—Press **OK** to start the update process. Your TV uses your current wireless network name and password to reconfirm the wireless connection, the local network connection, and the Internet connection.
- **Set up new Wi-Fi connection**—Press **OK** to start a scan for wireless networks. Your TV scans for the wireless networks within range and displays the first few it finds in order, with the strongest signals first. In addition to your own wireless signal, your TV might pick up signals from your neighbors. Now you can do one of the following:
 - **Select your network name**—Select the name of your network and then enter your wireless password if requested.
 - **Scan again**—If you don't see your wireless network name in the list, select **Scan again** to list all networks in range. The first scan listed only the first few, strongest wireless signals. The second scan sometimes results in a longer list. If you still don't see your network name, you might need to adjust the location of the wireless router or your TV, turn on your router, or make other changes. When everything is ready, select **Scan again** to repeat the network scan.

Note

Highlighting **Scan Again** displays an informational panel with the unique media access control (MAC) address of your TV. You will need the MAC address if your wireless router is configured to use MAC address filtering.

- **Private network**—If your wireless network name is hidden, it won't appear in the list. Select **Private network** to display an on-screen keyboard, and use it to enter your network name. Unless you changed the factory-set network name, you can find the name (also called SSID) on a label on the router.

Note

Wireless networks that are password-protected display a "padlock" icon adjacent to the name.

MyHomeNetwork



Note

Some wireless networks, such as those found in dorm rooms, hotels, and other public places, may require you to read and agree to terms, enter a code, or provide identifying information before letting you connect to the Internet. If the TV detects that you are connecting to such a network, it prompts you through the connection process using your smartphone or tablet to provide the needed information. For more information, see [Using your TV in a hotel or dorm room](#) on page 47.

Changing caption settings

You can change many different settings that affect the appearance of captions.

To change caption settings, from the **Home** screen menu, navigate to **Settings > Captions**, and then press the **RIGHT** arrow. At this point, you can choose the following options:

- **Captions mode**—Choose **Off**, **On**, **Instant replay**, or **When mute**.
 - If you choose **On**, your TV displays captions whenever they are available in the program information. This setting applies to Antenna TV, the AV input, and streaming channels.
 - If you choose **Instant Replay**, your TV displays captions only during a replay operation; that is, after pressing ↶ to jump back a few seconds in streaming video. This setting applies only to streaming channels when the program being streamed supports instant replay.
 - If you choose **When mute**, your TV displays captions only when the sound is muted. This setting applies to Antenna TV, the AV input, and streaming channels.

Note

If ↶ is not available on your remote control, you can use ↶ on the Roku mobile app or the Jump Back button on a universal remote. For more information, see [Other devices](#) on page 69.

This setting reflects the **Closed captioning** settings in the *Options* menu for certain TV inputs, as explained in [Options menu settings](#) on page 50. Note that, once enabled, the captions mode remains set for all applicable inputs until you turn it off.

Note

Some streaming channels require you to enable captions through a setting within their channel even though you have turned on captions everywhere else.

- **Text style**—Choose from a list of fonts. As you move the highlight to each font, you can see a sample of the result in an adjacent panel.
- **Text edge effect**—Choose from a list of edge effect styles, such as raised, depressed, and various shadows. As you move the highlight to each effect, you can see a sample of the result in an adjacent panel.
- **Text size**—Choose from a list of sizes. As you move the highlight to each size, you can see a sample of the result in an adjacent panel.
- **Text color**—Choose from a list of colors for the text. As you move the highlight to each color, you can see a sample of the result in an adjacent panel.
- **Text opacity**—Choose from a list of opacity settings for the text. This setting determines how much the area behind the text shows through the text. A value of 100% blocks all of the content behind the text. As you move the highlight to each setting, you can see a sample of the result in an adjacent panel.
- **Background color**—Choose from a list of colors for the background area behind the text. As you move the highlight to each color, you can see a sample of the result in an adjacent panel. Note that you won't see any change unless you set the **Background opacity** to a value other than **Off**.
- **Background opacity**—Choose from a list of opacity settings for the background of the caption. This setting determines how much the area behind the caption background shows through the background. A value of 100% blocks all of the content behind the background. As you move the highlight to each setting, you can see a sample of the result in an adjacent panel.
- **Window color**—Choose from a list of colors for the window rectangle surrounding the entire caption. As you move the highlight to each color, you can see a sample of the result in an adjacent panel. Note that you won't see any change unless you set the **Window opacity** to a value other than **Default** or **Off**.
- **Window opacity**—Choose from a list of opacity settings for the window rectangle surrounding the entire caption. This setting determines how much the area behind the caption window shows through the window. A value of 100% blocks all of the content behind the window. As you move the highlight to each setting, you can see a sample of the result in an adjacent panel.

Changing time settings

You can change time settings to suit your preferences. You can find the following settings by navigating from the **Home** screen menu to **Settings > System > Time**:

- **Sleep timer**—Set a time delay after which your TV will automatically shut off. This setting reflects the setting you can make in the *Options* menu from any TV input, as explained in [Options menu settings](#) on page 50. Note that the sleep timer setting is not input specific.
- **Time zone**—Select whether to set the time zone automatically or manually, and if set manually, select your current time zone. Typically, a TV connected to the Internet can discover its own time zone automatically, and a TV that is not connected to the Internet must be set manually. Initially, this setting is made when you set up the TV tuner, as explained in [Setting up Antenna TV](#) on page 41. Correct time zone information is needed to correctly display program data.
- **Clock format**—Select whether to display time in a 12-hour or 24-hour format, or to turn off time display. This setting is available only on TVs that are connected to the Internet. Non-connected TVs do not display the time.

Scanning for broadcast TV channels again

There will be times when you need to create a new channel list. For example, you:

- Change cable providers
- Reorient your TV antenna
- Move to a different city with different channels

Whenever you need to update your TV channel list, you can repeat the channel scan.

Tip

Repeat the channel scan from time to time to make sure you are receiving all of the latest channels. Broadcasters add and remove channels, move channels to different parts of the spectrum, and change the power levels of their channels periodically.

To repeat the channel scan, from the **Home** screen menu, navigate to **Settings > TV inputs > Antenna TV > Scan again** for channels. Then select **Start finding channels** to begin the channel scan process. The screens and options that appear during this process are identical to those described in [How do I set up the TV tuner?](#) on page 42.

Using your TV in a home theater

Your TV has several features that make it an ideal TV for a home theater. But you might not notice them because they remain in the background until you decide to use them.

Turning off the speakers

When you use your TV with a sound bar or an external amplifier and speakers, you'll probably want to turn off the internal TV speakers.

To turn off your TV's built-in speakers, in the **Home** screen menu, navigate to **Settings > Audio > TV speakers** and change the setting.

Tip

Your TV's internal speakers can be enabled and disabled automatically as needed by system audio control, as described in [Enabling system audio control](#) on page 66. The internal speakers are also turned off when you use the headphone jack.

Changing the audio mode

Your TV has two audio modes, accessed by navigating in the **Home** screen menu to **Settings > Audio > Audio mode**:

- **Stereo**—Use this setting for internal speakers, headphones, and external stereo amplifiers connected through the **HDMI1 (ARC)**, **SPDIF**, or headphone jack.
- **Auto**—Use this setting to automatically detect the best audio setting based on the audio stream in the content you are watching. If you have connected your TV to an external Dolby Digital or Dolby Digital Plus compatible amplifier, receiver, or sound bar through **HDMI1 (ARC)** or **SPDIF**, your TV automatically selects the appropriate surround sound capabilities of the device based on the characteristics of the current program.

Setting up a digital audio connection

You can connect your TV to an external amplifier, receiver, or sound bar by using either of these two connections:

- **HDMI ARC**—The HDMI Audio Return Channel enables your TV to output digital audio on one of its HDMI connectors. The connected amplifier can also function simultaneously as an input source to your TV, if needed. To use the ARC capability, you must connect an HDMI cable from your amplifier's HDMI ARC connector to the **HDMI1 (ARC)** connector on your TV. You also must:
 - Be sure your HDMI cable is certified by HDMI.
 - Enable HDMI ARC under **Settings > System > Control other devices (CEC)**, as explained in [Enabling HDMI ARC](#) on page 66.
- **SPDIF**—Your TV has an **SPDIF** connector that outputs a digital audio signal. To use the optical output, connect a digital optical audio cable from the amplifier to the **SPDIF** connector on your TV.



Note

Dolby Digital Plus format is not available through the **SPDIF** output. This format is only available through the **HDMI1 (ARC)** connection.

After making the required HDMI ARC or digital optical audio connection, go to **Settings > Audio > SPDIF and ARC** option and select the audio format to use.

Note

In most cases, **Auto detect** is the best option. Other settings can result in no sound when the content you are viewing does not contain the audio stream type you selected.

Controlling other devices through CEC

Consumer Electronics Control (CEC) enables your TV and other CEC-compatible home entertainment components to control one other in various ways. First, the CEC-compatible devices must “discover” one another and report their capabilities. After this, one device can control another according to the features you enable. For example, playing a disc on a Blu-ray player could switch your TV to the Blu-ray player's input. Or, powering off your TV could also power off the Blu-ray player and the home theater receiver.

Discovering connected CEC devices

To discover CEC devices:

- 1 Make sure that your CEC-compatible components are connected to your TV with a suitable high-speed HDMI cable that supports HDMI ARC and CEC control.
- 2 Turn on each component and make sure all components have CEC enabled.

Tip

Some manufacturers have their own branded names for CEC functionality, so you might need to read the product documentation to correctly identify the CEC features of the device.

- 3 On your TV's **Home** screen menu, navigate to **Settings > System > Control other devices (CEC)** and then select **Search for CEC devices**. Press **OK** to repeat the discovery process, if necessary.

When finished, your TV displays a list of CEC devices that are connected to each HDMI input, as well as any devices that had previously been connected. Your TV remembers the names of multiple CEC devices even when they are no longer connected. If the list is longer than the allowed space, press ***** to see a complete list in a scrollable window.

Enabling HDMI ARC

HDMI1 (ARC) is the audio return channel that is available on one of your TV's HDMI ports. The audio return channel enables you to send a Dolby Digital audio signal back to a home theater receiver that is also sending an audio and video signal into your TV. Using HDMI ARC reduces the number of cables needed and optionally lets you control the volume and mute state of the receiver by enabling system audio control.

HDMI ARC is disabled by default. To enable HDMI ARC, in the **Home** screen menu, navigate to **Settings > System > Control other devices (CEC)**, and then highlight **HDMI ARC**. Press **OK** to enable or disable the feature.

Note

Enabling **HDMI ARC** also enables **System audio control**. After enabling **HDMI ARC**, you can disable **System audio control** if you prefer.

Enabling system audio control

System audio control enables your TV remote control to change the volume and mute state of an amplifier or sound bar connected through HDMI, and to display the external device's volume and mute status in your TV's on-screen display.

Your TV automatically turns off its internal speakers and sends volume and mute control signals to an external amplifier when all of the following are true:

- **System audio control** is enabled on your TV.
- Your TV is connected to a CEC-compatible amplifier, it is powered on, and CEC discoverability is enabled.
- The CEC-compatible amplifier's HDMI ARC connector is connected to your TV's **HDMI1 (ARC)** connector with a suitable HDMI cable.

When the CEC-compatible amplifier is off, your TV automatically turns on its speakers (unless you have turned them off as described in [Turning off the speakers](#) on page 65) and resumes local control of volume and mute state.

To enable or disable system audio control, in the **Home** screen menu, navigate to **Settings > System > Control other devices (CEC)** and highlight **System audio control**. Press **OK** to enable or disable the feature.

Enabling 1-touch play

1-touch play enables a component to control which TV input is active. For example, pressing **Play** on your Blu-ray player switches your TV to the Blu-ray input.

1-touch play is disabled by default. To enable 1-touch play, in the **Home** screen menu, navigate to **Settings > System > Control other devices (CEC)** and highlight **1-touch play**. Press **OK** to enable or disable the feature.

Enabling system standby

The system standby feature causes other components to power off when you power off your TV. Depending on the CEC System Standby implementation, it also might enable connected components to power off your TV when you power off the component.

System standby is disabled by default. To enable system standby, in the **Home** screen menu, navigate to **Settings > System > Control other devices (CEC)** and highlight **System standby**. Press **OK** to enable or disable the feature.

Restarting your TV

You can restart your TV when necessary. Restarting has the same effect as unplugging your TV power and then plugging it in again.

To restart your TV, navigate to **Settings > System > Power** and then select **System restart**. Highlight **Restart**, and then press **OK** to confirm restart.

While your TV restarts, the screen goes dark for a few seconds, and then displays the startup screen for a few more seconds. When the restart operation completes, the TV displays the activity you selected in [Power on settings](#) on page 58.

Resetting your TV

You can choose to reset only your TV picture and audio settings to their original values, or perform a full factory reset to return your TV to the state it was in when you first unpacked and turned it on.

Reset audio/video settings

To reset only your TV picture and audio settings to their original values, navigate to **Settings > System > Advanced system settings > Factory reset**, and then highlight **Reset TV audio/video settings**. Read the information on the screen to make sure you understand what the reset operation does.

To proceed with the reset operation, press **PLAY/PAUSE** three times in a row.

Factory reset everything

A full factory reset returns your TV to its original, out-of-the-box state. When finished, you must repeat Guided Setup, reconnecting to the Internet, re-linking your Roku account, and reloading any streaming channels. You also must repeat Antenna TV setup and input configuration.

Factory reset is the recommended choice if you want to transfer your TV to another owner, and is the only choice if you want to switch from store mode to home mode (if you inadvertently selected store mode during Guided Setup).

To perform a factory reset, navigate to **Settings > System > Advanced system settings > Factory reset**, and then highlight **Factory reset everything**. Read the information on the screen to make sure you understand what this reset operation does.

To proceed with the full factory reset, use the on-screen number pad to enter the code displayed on the screen, and then select **OK** to proceed.

When the factory reset operation completes, your TV restarts and displays the first Guided Setup screen.

What if I can't access the Factory Reset option?

It is possible that your TV might get into a state where you cannot access the various menus, including the menu option that lets you perform a factory reset operation. If that happens, you can force your TV to reset by following these steps:

1 Using a straightened paper clip or ball-point pen, press and hold the recessed **RESET** button on your TV connector panel.

2 Continue to hold the **RESET** button for approximately 15 seconds.

During this time, the status light turns off, and then turns on bright, and then pulses. When the reset cycle completes, the light either comes on dim (if your TV power was off when you started) or your TV screen comes on and the light turns off (if your TV power was on when you started).

3 When the status light turns on steady dim or your TV screen comes on, release the **RESET** button.

4 Proceed through Guided Setup. See [Setting up your TV](#) on page 33.

Changing your Roku Channel Store PIN preference

When you created your Roku account, you were given the opportunity to create a PIN code and to specify when it must be used. If you created a Channel Store PIN and want to change it, or you don't remember your PIN, or if you didn't create a Channel Store +PIN and want to add one, you can easily make these changes.

1 On a computer, tablet, or smartphone, use your web browser to go to <https://my.roku.com>.

2 Enter your email address and password to sign in. After signing in, the *My Account* page appears.

3 Under **PIN Preference**, click **Update** to open the *Choose Your PIN Preferences* page.

4 Skip this step if you just want to change your PIN. Otherwise, choose the option you prefer from among those listed:

- Require a PIN to make purchases or to add any item from the Channel Store.
- Require a PIN to make purchases.
- Do not require a PIN to make purchases.

5 If you choose either of the first two options, enter your PIN twice in the appropriate boxes.

6 Click **Save Changes** to save your changes and return to the *My Account* page. Note that your current setting is described under **PIN Preference**.

Getting system updates

If your TV is connected to the Internet and linked with a Roku account, it will automatically get updates from time to time. You don't need to do anything. But if you are aware that an update is available and you don't want to wait until your TV updates itself, you can manually check for updates.

If your TV is not connected to the Internet, you can still get updates by using a USB flash drive.

You can download an updated *User Guide* that matches your Roku TV software version from the Insignia web site at:

www.insigniaproducts.com/support.html

To determine your current Roku TV software version, go to **Settings > System > About**, and then press **OK** or navigate to the right.

Checking for updates on a connected TV

If you're one of those people who has to have the latest, most up-to-date features the moment they are available, you can check for updates as often as you want.

To check for updates, navigate to **Settings > System > System update**, and then select **Check now**. Your TV responds either with a message saying that your TV is up to date, or with a message saying that an update is available.

Follow the instructions on the screen to install the system update.

Note

Sometimes system updates install new system software, and other times they install new features for streaming channels. Therefore, you won't always see a change in the behavior of your TV after a system update.

Getting updates on a non-connected TV

If your TV is not connected to the Internet, you can still get system updates by using a USB flash drive and a computer with an Internet connection.

To get a system update, navigate to **Settings > System > System update**:

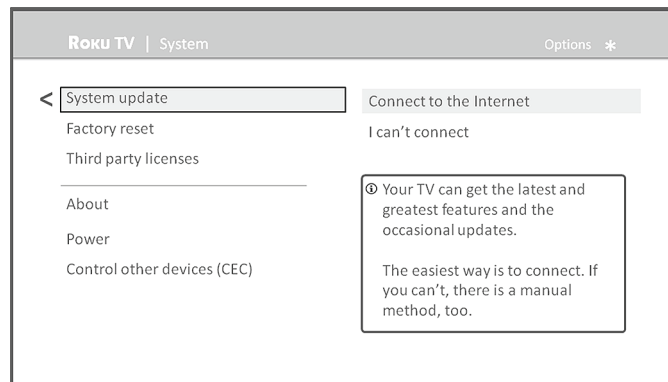

The *System update* screen on a non-connected TV gives you the opportunity to connect your TV to the Internet to automatically receive updates. We recommend this option if it is possible in your situation. To proceed, select **Connect to the Internet** and follow the instructions in [But what if I didn't connect my TV?](#) on page 41.

Otherwise, if you can't connect to the Internet, select **I can't connect**, and then follow the instructions on the screen. Here's a summary:

- 1 On an Internet-connected computer, go to the web site displayed on the *System update* screen.
- 2 On the *USB Update* web page, select the correct brand and model and then click **Download**. Save the file to the root folder of a standard USB flash drive.
- 3 When the download finishes, take the USB flash drive to your TV and plug it into the USB port. When you do, your TV validates the files on the flash drive and displays a 12-digit code.
- 4 Write down the code and the web address, and take this information back to your Internet-connected computer.

USB flash drive

Any normal USB flash drive will work, provided it has a FAT-16 or FAT-32 file system format. (This is the default for most flash drives.)

The size of the download is small—usually less than 100 MB—and so will fit on any size flash drive you might have.

- 5 On the *12-digit code* page, enter the code your TV displayed, and then click **Next**.
- 6 On the *6-digit code* page, write down the 6-digit code that appears, and then take it back to your TV.
- 7 Using your TV remote control, select **Next** to move to the next screen, and then use the on-screen keyboard to enter the 6-digit code. When finished, select **OK**. The system update begins. Do not remove the USB flash drive until your TV restarts.

12- and 6-digit codes

The USB update process uses a pair of codes to validate that you are authorized to install an update, and to ensure you are not attempting to install an old, unsupported version of the system software.

When the update finishes, your TV restarts. You can check the new version number by navigating to **Settings > System > About**.

Other devices

Screen Mirroring your phone or tablet

Your TV has a feature called screen mirroring that lets you mirror your compatible smartphone or tablet on your TV. Share videos, photos, web pages, and more from compatible devices. This screen mirroring feature is in a 'beta' period, which lets you try it out and allows Roku to learn what needs to be improved—so don't be surprised if it doesn't work perfectly.

For information on which devices may work with screen mirroring and instructions on how to use it, see <https://support.roku.com/hc/en-us/articles/208754928-Roku-screen-mirroring-overview>

Notes

- Many features work with top mobile devices. Please see <https://support.roku.com> for compatibility information.
- Your TV must be connected to the Internet and linked to a Roku account to use screen mirroring. The Screen Mirroring option is not available on non-connected TVs.

Getting and using the Roku mobile app

Roku makes the Roku mobile app free for compatible iOS, Android, and Microsoft Windows 8/8.1 devices.

With the Roku mobile app, you can control your TV, find and add new Roku Channels, more easily search and find something to watch, and even use your voice to search without typing. More information can be found by going to <http://support.roku.com/home> and searching for "mobile app."

Using a universal remote

In many cases, you can program your cable or satellite universal remote control to also control your TV. You will need to have instructions for programming the remote control handy. Check with your cable or satellite provider for instructions.

For details on how to set up your TV to work with universal remote controls, visit www.roku.com/universremote.

Maintaining

- Do not use your TV in areas that are too hot or too cold, because the cabinet may warp or the screen may malfunction. Your TV works best in temperatures that are comfortable to you.
- Storage temperatures are 5° to 113°F (-15° to 45°C).
- Working temperatures are 41° to 95°F (5° to 35°C).
- Do not place your TV in direct sunlight or near a heat source.

Cleaning your TV cabinet

Clean the cabinet with a soft, lint-free cloth. If the cabinet is especially dirty, moisten a soft, lint-free cloth in a weak detergent solution, squeeze the excess moisture from the cloth, then wipe the cabinet with the cloth. Use a clean cloth to dry the cabinet.

Cleaning your TV screen

Clean the screen with a soft, lint-free cloth.

SHARP • Roku TV

Troubleshooting

LC-43LB371U/LC-50LB371U 43"/50" 1080p, 60Hz, LED Sharp Roku TV

Warning

Do not try to repair your TV yourself. Contact authorized service personnel.

Note

If the problem is not solved by using these troubleshooting instructions, turn off your TV, then turn it on again.

FAQ

For the latest answers to Frequently Asked Questions, visit Common Questions section of the <http://www.sharppusa.com/manuals/hd.aspx> and the Support section of the Roku website (www.roku.com).

Video and audio

Symptom	Possible cause	Try this...
Picture does not fill the screen or there are black bars around the picture	The picture size may need to be adjusted	<ul style="list-style-type: none"> Adjust the picture size (aspect ratio). See the Picture Size option in Advanced picture settings menu options on page 51.
I don't see a picture when I select an input	TV is not on	<ul style="list-style-type: none"> Make sure that your TV is plugged into a working power outlet, and that your TV is turned on. (Your TV had a light on the front that indicates if your TV is turned off. See Status light on page 45.)
	Cables are not connected correctly	<ul style="list-style-type: none"> Make sure that the video cables are connected correctly and securely to your TV. Make sure that the antenna or cable TV is connected correctly and securely. See Connecting a cable or satellite box on page 15 or Connecting an antenna or cable TV (no box) on page 18.
	Picture settings may be incorrect	<ul style="list-style-type: none"> Adjust the contrast and brightness. See the TV brightness option in Settings menu on page 49 or Options menu on page 50. Adjust the TV picture. See Advanced picture settings on page 51.
	Incorrect input may be selected	<ul style="list-style-type: none"> Make sure that the correct input is selected for the device you want to view. See Switching TV inputs on page 46.
	Input source not detected	<ul style="list-style-type: none"> Make sure that the device connected to the input is turned on. Make sure that the cord to and from the device is connected firmly and correctly to the device and your TV.
	TV input may be bad	<ul style="list-style-type: none"> Connect a different device to the same input and check to see if it works correctly.
TV channel does not appear	Broadcast TV may be experiencing problems or may not be set up	<ul style="list-style-type: none"> Try another channel. The station may be experiencing problems. Make sure that the incoming signal is compatible. If you are trying to watch broadcast TV, make sure that Antenna TV is set up. See Setting up Antenna TV on page 41.

Symptom	Possible cause	Try this...
Dark, poor, or no picture (screen is lit), but sound is good	Broadcast TV may be experiencing problems or may not be set up	<ul style="list-style-type: none"> Try another channel. The station may be experiencing problems. If you are using an antenna and the signal strength is low, adjust the antenna or use a highly directional outdoor antenna or set-top antenna with a built-in amplifier.
	Cables may not be connected correctly	<ul style="list-style-type: none"> Make sure that the antenna or cable TV is connected correctly and securely. See Connecting a cable or satellite box on page 15 or Connecting an antenna or cable TV (no box) on page 18. Make sure that the video cables are connected correctly and securely to your TV. The video cable(s) you are using may be bad. Try a new set.
	Picture settings may be incorrect	<ul style="list-style-type: none"> Adjust the brightness. See the TV brightness option in Settings menu on page 49 or Options menu on page 50. Change to a different picture mode. See the Picture mode option in Options menu settings on page 50 or Advanced picture settings menu options on page 51.
No color, dark picture, or color is not correct	Picture settings may be incorrect	<ul style="list-style-type: none"> Adjust the contrast, color, and brightness settings. See the TV brightness option in Settings menu on page 49 or Options menu on page 50.
	Broadcast TV may be experiencing problems	<ul style="list-style-type: none"> Try another channel. The station may be experiencing problems. If you are using an antenna and the signal strength is low, adjust the antenna or use a highly directional outdoor antenna or set-top antenna with a built-in amplifier.
	Cables are not be connected correctly	<ul style="list-style-type: none"> Make sure that the antenna or cable TV is connected correctly and securely. See Connecting a cable or satellite box on page 15 or Connecting an antenna or cable TV (no box) on page 18. Make sure that the video cables are connected correctly and securely to your TV. The video cable(s) you are using may be bad. Try a new set.
Only snow (noise) appears on the screen	Broadcast TV may be experiencing problems or may not be set up	<ul style="list-style-type: none"> Try another channel. The station may be experiencing problems. If you are trying to watch broadcast TV, make sure that Antenna TV is set up. See Setting up Antenna TV on page 41. If you are using an antenna and the signal strength is low, adjust the antenna or use a highly directional outdoor antenna or set-top antenna with a built-in amplifier.
	Cables may not be connected correctly	<ul style="list-style-type: none"> Make sure that the antenna or cable TV is connected correctly and securely. See Connecting a cable or satellite box on page 15 or Connecting an antenna or cable TV (no box) on page 18.
Picture quality is good on some channels and poor on others. Sound is good	Broadcast signal may be weak	<ul style="list-style-type: none"> If you connect to cable without a set-top box and experience poor picture quality, you may need to install a set-top box to improve signal reception and picture quality. Contact your cable TV provider about upgrading to a set-top box.

Symptom	Possible cause	Try this...
Dotted lines or stripes appear on the screen	Cables may not be connected correctly	<ul style="list-style-type: none"> Make sure that the antenna or cable TV is connected correctly and securely. See Connecting a cable or satellite box on page 15 or Connecting an antenna or cable TV (no box) on page 18. Make sure that the video cables are connected correctly and securely to your TV. The video cable(s) you are using may be bad. Try a new set.
	Broadcast signal may be weak	<ul style="list-style-type: none"> If you are using an antenna and the signal strength is low, adjust the antenna or use a highly directional outdoor antenna or set-top antenna with a built-in amplifier. Other devices (for example, a surround sound receiver, external speakers, fans, or hair dryers) may be interfering with your TV. Try turning off one device at a time to determine which device is causing interference. After you have determined which device is causing interference, move it further from your TV to eliminate the interference.
Double images	Broadcast signal may be weak	<ul style="list-style-type: none"> If you are using an antenna and the signal strength is low, adjust the antenna or use a highly directional outdoor antenna or set-top antenna with a built-in amplifier. If you are using an antenna and the signal strength is low, switch to a cable or satellite box.
The picture has a few bright or dark spots	This is normal in LED TVs	<ul style="list-style-type: none"> A few bright or dark spots on an TV screen is normal. It does not affect the operation of your TV.
Good picture, but no sound	Volume is down or muted	<ul style="list-style-type: none"> Increase the volume. Make sure that the sound is not muted.
	Headphones may be connected	<ul style="list-style-type: none"> Make sure that you do not have headphones connected. When headphones are connected, no sound comes from your TV speakers.
	TV speakers may be turned off	<ul style="list-style-type: none"> If you want sound to play through your TV speakers, make sure that your TV speakers are turned on. See Turning off the speakers on page 65.
	You may need to change the audio mode	<ul style="list-style-type: none"> Change to a different audio mode. See Changing the audio mode on page 65.
	Home theater system, sound bar, or external speaker system may not be turned on or may not be set up correctly	<ul style="list-style-type: none"> If you are using a home theater system, sound bar, or external speaker system, make sure that it is turned on and is not muted and that it is set to the correct source. If you connected an ARC audio device to the HDMI1 (ARC) jack, make sure that you have turned on the ARC feature. See the HDMI ARC option in Setting up a digital audio connection on page 65. If you are using a home theater system, sound bar, or external speaker system and have connected it with a digital audio cable, see Setting up a digital audio connection on page 65. Make sure that the audio cables are connected correctly and securely to your TV.
	Bad content, no audio	<ul style="list-style-type: none"> Make sure that the selected channel or content is intended to be broadcasting with sound.
	Cables may not be connected correctly	<ul style="list-style-type: none"> Make sure that the antenna or cable TV is connected correctly and securely. See Connecting a cable or satellite box on page 15 or Connecting an antenna or cable TV (no box) on page 18. The audio cables you are using may be bad. Try a new set.

Symptom	Possible cause	Try this...
Poor picture	Light in the viewing area may be interfering	<ul style="list-style-type: none"> Make sure that the room is not too bright. Light reflecting off the screen can make the picture difficult to see.
	A connected camera or camcorder may be interfering	<ul style="list-style-type: none"> If an S-VHS camera or a camcorder is connected while another connected device is turned on, the picture may be poor. Turn off one or more devices.
Audio noise	Other devices may be interfering	<ul style="list-style-type: none"> Other devices (for example, a surround sound receiver, external speakers, fans, or hair dryers) may be interfering with your TV. Try turning off one device at a time to determine which device is causing interference. After you have determined which device is causing interference, move it further from your TV to eliminate the interference.
After images appear		<ul style="list-style-type: none"> Do not display a still image, such as a logo, game, or computer image, for an extended period of time. This can cause a permanent after-image to be burned into the screen. This type of damage is not covered by your warranty.

Remote control

Symptom	Possible cause	Try this...
My TV doesn't turn on using the remote control	No power to TV	<ul style="list-style-type: none"> Make sure that the power cord is correctly connected to both your TV power connector and power outlet. See Connecting power on page 30. You should see an LED in the front of the TV panel when a button on the remote is pressed. If you see no LED activity, try another outlet or check your fuse box.
	Line-of-sight obstructed	<ul style="list-style-type: none"> Make sure that no objects (or pets) are obstructing the line-of-sight from the remote control to the remote sensor on the front of your TV. See Aiming the remote control on page 31.
	Remote not responding	<ul style="list-style-type: none"> Open the battery compartment and make sure that the batteries are seated in the correct positions (+ and - in the correct positions). See Installing remote control batteries on page 31. Make sure the batteries are fresh and working correctly. Replace the batteries, if necessary.
	TV frozen	<ul style="list-style-type: none"> If the front LED is not responding, or abnormally bright, disconnect the power cord from power outlet, wait a few seconds, then reconnect the power cord.
Trouble programming your existing universal remote control	Remote control may not be programmed correctly	<ul style="list-style-type: none"> See instructions in Using a universal remote on page 69. For instructions on programming a universal remote control, visit: www.roku.com/universalremote Refer to the User Guide that accompanied your universal remote control and contact the manufacturer if problems persist.
	Batteries may be dead	<ul style="list-style-type: none"> Replace dead batteries with new batteries. Refer to the User Guide that accompanied your universal remote control.

General

Symptom	Possible cause	Try this...
No power	Power cord may not be connected correctly	<ul style="list-style-type: none"> Make sure that the power cord is correctly connected to both your TV power connector and power outlet. See Connecting power on page 30. You should see an LED in the front of your TV panel when a button on the remote is pressed. If you see no LED activity, try in another outlet or check your fuse box. Unplug the power cord, wait 60 seconds, then plug the cord back in and turn on your TV.
	Other devices may be interfering	<ul style="list-style-type: none"> Other devices (for example, a surround sound receiver, external speakers, fans, or hair dryers) may be interfering with your TV. Try turning off one device at a time to determine which device is causing interference. After you have determined which device is causing interference, move it further from your TV to eliminate the interference.
My TV tuner does not pick up as many over-the-air channels as it should	Antenna may not be placed optimally	<ul style="list-style-type: none"> Adjust the antenna location and rescan. See Scanning for broadcast TV channels again on page 65. Go to Settings>Input. Reception can vary by channel depending on the broadcast power level of a given station. Contact your cable or satellite TV provider. Make sure that the antenna or cable/satellite TV is connected securely to your TV. Try replacing the cable between the antenna/cable or cable/satellite box and your TV.
	Broadcast TV may not be set up	<ul style="list-style-type: none"> Make sure that Antenna TV is set up. See Setting up Antenna TV on page 41.
One or more channels do not display	Channels may be blocked or hidden	<ul style="list-style-type: none"> Make sure that the channels are not blocked. See Blocking unrated programs on page 61. Make sure that the channels are not hidden. The channel may have been deleted from the channel list. You can add the channel back to the channel list. See Edit broadcast TV channel lineup on page 57.
	The wrong input may be selected	<ul style="list-style-type: none"> Make sure that you have selected the correct input tile for the device or service you are trying to use. See Switching TV inputs on page 46.
	You may need to use the remote control that came with the cable or satellite box	<ul style="list-style-type: none"> If you are using a cable or satellite box, use the remote that came with that box to change channels.
I lost my parental control PIN	Need PIN recovery	<ul style="list-style-type: none"> You will need to factory reset your TV, as the PIN cannot be recovered or reset any other way. See Factory reset everything on page 67. Go to Settings>System>Factory reset.
Some settings cannot be accessed	Not all settings are available for all devices or inputs	<ul style="list-style-type: none"> If the ✱ icon or a menu option is grayed, you cannot adjust settings for the current video input mode.
TV cabinet creaks	This is normal	<ul style="list-style-type: none"> When your TV is in use, the temperature rises naturally and may cause the cabinet to expand or contract which can cause a creaking noise. This is not a malfunction.
Control buttons do not work	TV may be frozen	<ul style="list-style-type: none"> Unplug the power cord, wait a few seconds, then plug the cord back in and turn on your TV.
TV keeps turning off	Sleep time may be turned on	<ul style="list-style-type: none"> Make sure that the sleep timer is not turned on. See the Sleep Timer option in Options menu settings on page 50 or Changing time settings on page 64.

Symptom	Possible cause	Try this...
Some features are not available	The wrong TV mode may be selected	<ul style="list-style-type: none"> You may have Set up for store mode when you set up your TV. Store use mode is for retail environments only. In Store use mode, some of your TV's features are missing or limited. If you selected Set up for store use and you want to change to Set up for home use, you have to reset your TV to the factory defaults. See Factory reset everything on page 67. Go to Settings>System>Factory reset.

Roku

Symptom	Possible cause	Try this...
I can't turn my TV on with the Roku mobile app	Your TV is "asleep"	<ul style="list-style-type: none"> You will need to use the physical remote button to "wake up" or turn on your TV.
I can't find my TV with the Roku mobile app	TV and mobile app not on same wireless network	<ul style="list-style-type: none"> Make sure that your TV and the mobile app are on the same network.
	TV not powered or working normally	<ul style="list-style-type: none"> Make sure that your TV is connected to a working power outlet and that your TV is turned on. See Connecting power on page 30.
I cannot screen mirror to my TV	TV on older software	<ul style="list-style-type: none"> Always keep your TV updated. See Getting system updates on page 68. Go to Settings>System>Software update.
	Mobile device not supported	<ul style="list-style-type: none"> Screen mirroring is a beta feature currently, so a select set of devices will work.

Network

Symptom	Possible cause	Try this...
I cannot connect to the Internet	Network connection may not be set up	<ul style="list-style-type: none"> If you did not connect to the Internet when you first set up your TV, see But what if I didn't connect my TV? on page 41.
	Network name or password may have changed	<ul style="list-style-type: none"> If your network name or password had changed, you need to update your network connection. See Changing network settings on page 63.
Streaming keeps pausing to load more data	Wireless LAN not optimized	<ul style="list-style-type: none"> Rotate wireless router slightly Elevate the router Turn off other wireless connections Use 5.0Ghz, if possible. Roku TVs supports dual band.
	Insufficient broadband speed	<ul style="list-style-type: none"> Turn off other wireless connections that may also be using bandwidth.

CEC-compatible devices

Symptom	Possible cause	Try this...
My TV is not displaying the video from the connected CEC device	Cables may not be connected correctly	<ul style="list-style-type: none"> • Make sure that the HDMI cable is connected securely to your TV and the device. • Make sure that the device is connected to your TV with an HDMI cable.
	Picture settings may be incorrect	<ul style="list-style-type: none"> • Try adjusting your TV picture. See Advanced picture settings on page 51.
	The selected input may be incorrect	<ul style="list-style-type: none"> • Make sure that the correct input tile is selected. See Switching TV inputs on page 46.
	Connected device may not be a CEC device	<ul style="list-style-type: none"> • Make sure that the device is a CEC device. See the documentation that came with the device for more information.
	CEC control may not be set up correctly	<ul style="list-style-type: none"> • Make sure that your TV has searched for CEC devices. See Discovering connected CEC devices on page 66.
My TV is not playing the audio from the connected CEC device.	Cables may not be connected correctly	<ul style="list-style-type: none"> • Make sure that the HDMI cable is connected securely to your TV and the device.
	Volume may be too low or muted	<ul style="list-style-type: none"> • Make sure that the volume on your TV and the device is turned up and not muted.
	TV speakers may be turned off	<ul style="list-style-type: none"> • If you want sound to play through your TV speakers, make sure that your TV speakers are turned on. See Turning off the speakers on page 65.
	Connected device may not be a CEC device	<ul style="list-style-type: none"> • Make sure that the device is a CEC device. See the documentation that came with the device.
	CEC control may not be set up correctly	<ul style="list-style-type: none"> • Make sure that your TV has searched for CEC devices. See Discovering connected CEC devices on page 66.
	Connected audio device may not be set up correctly	<ul style="list-style-type: none"> • If you are using a home theater system, sound bar, or external speaker system, make sure that it is set to the correct source. • If you are using a home theater system, sound bar, or external speaker system and have connected it with a digital audio cable, make sure that you have set up digital audio. See Setting up a digital audio connection on page 65. • If you connected an ARC audio device to the HDMI1 (ARC) jack, make sure that you have turned on the ARC feature. See Enabling HDMI ARC on page 66.

Symptom	Possible cause	Try this...
My TV's remote control does not control the device	Connected device may not be turned on	<ul style="list-style-type: none"> Make sure that the device is turned on.
	Line-of-sight obstructed	<ul style="list-style-type: none"> Make sure that no objects (or pets) are obstructing the line-of-sight from the remote control to the remote sensor on the front of your TV and the device. See Aiming the remote control on page 31.
	Connected device may not support some or all CEC features	<ul style="list-style-type: none"> Depending on the device, all the buttons may not work. The device may not support this feature. See the documentation that came with the device for more information.
	CEC control may not be set up correctly	<ul style="list-style-type: none"> Make sure that your TV has searched for CEC devices. See Discovering connected CEC devices on page 66. If you are trying to control the volume on an HDMI CEC audio receiver using your TV remote control, make sure that your TV speakers are turned on. See Turning off the speakers on page 65. If you are trying to control the volume on an HDMI CEC audio receiver using your TV remote control, make sure that the system audio control is turned on. See Enabling system audio control on page 66.
The device does not show up in the CEC device list	Connected device may not be a CEC device	<ul style="list-style-type: none"> Make sure that the device is a CEC device. See the documentation that came with the device.
	Cables may not be connected correctly	<ul style="list-style-type: none"> Make sure that the HDMI cable is connected securely to your TV and the device. Make sure that the device is connected to your TV with an HDMI cable.
	Connected device may not be a CEC device	<ul style="list-style-type: none"> Make sure that the device is a CEC device. See the documentation that came with the device.
	CEC control may not be set up correctly	<ul style="list-style-type: none"> Make sure that your TV has searched for CEC devices. See Discovering connected CEC devices on page 66.
My device does not turn off when I turn off my TV	Connected device may not be a CEC device	<ul style="list-style-type: none"> Make sure that the device is a CEC device. See the documentation that came with the device.
	Connected device may not support some or all CEC features	<ul style="list-style-type: none"> The device may not support this feature. See the documentation that came with the device for more information.
	CEC control may not be set up correctly	<ul style="list-style-type: none"> Make sure that your TV has searched for CEC devices. See Discovering connected CEC devices on page 66. Make sure that system standby is turned on. See Enabling system standby on page 66.
My TV does not turn on when I turn on my device	Connected device may not be a CEC device	<ul style="list-style-type: none"> Make sure that the device is a CEC device. See the documentation that came with the device.
	Connected device may not support some or all CEC features	<ul style="list-style-type: none"> The device may not support this feature. See the documentation that came with the device for more information.
	CEC control may not be set up correctly	<ul style="list-style-type: none"> Make sure that your TV has searched for CEC devices. See Discovering connected CEC devices on page 66. Make sure that 1-touch play is turned on. See Enabling 1-touch play on page 66.

Specifications

Specifications are subject to change without notice.

Dimensions and weight

	LC-43LB371U	LC-50LB371U
Without stand	38.1 × 22.5 × 3 in. (96.8 × 57.1 × 7.7 cm) 18.3 lb. (8.3 kg)	44.2 × 26 × 3 in. (112.4 × 66 × 7.7 cm) 28.1 lb. (12.8 kg)
With stand	38.1 × 23.6 × 9.4 in. (96.8 × 60 × 23.9 cm) 19 lb. (8.6 kg)	44.2 × 27.1 × 12.3 in. (112.4 × 68.9 × 31.3 cm) 29.2 lb. (13.3 kg)

Screen

	LC-43LB371U	LC-50LB371U
Screen size measured diagonally	42.6 in.	49.7 in.
Display type	LED	LED
Panel 60 Hz vs. 120 Hz	60Hz	60Hz
Display resolution	1080p	1080p
Panel resolution	1920 (H) × 1080 (V)	1920 (H) × 1080 (V)
Aspect ratio	16:9	16:9
Contrast ratio (typical)–panel	3,000:1	3,000:1
Dynamic contrast ratio–list value	120,000:1	120,000:1
TV Brightness (minimum) cd/m²	240 nits	240 nits
Comb filter	3d y/c digital	3d y/c digital
Response time	8 ms	8 ms
Horizontal viewing angle	178°	178°
Vertical viewing angle	178°	178°

Display resolutions (both models)

HDMI suggested resolutions	1080p, 1080i, 720p, 480p, 480i
-----------------------------------	--------------------------------

Tuner (both models)

Analog	NTSC
Digital	ATSC, 8-VSB, Clear-QAM

Inputs (both models)

HDMI	1 (side)/2 (back) EDID compliant HDCP compliant
Component video	No
Composite video	1 (back)
PC/VGA	No
3.5mm PC audio input	No
WiFi	Yes (built-in) Dual-band, 802.11 A/B/G/N
DVI	No
USB	1 (side) Supports image format: JPEG, PNG, GIF audio format: AAC, MP3, WMA, WAV(PCM), FLAC, AIFF, AC3(Dolby Digital) video format: MKV, MP4, MOV, TS firmware upgrade
Headphone	1 (side)
Antenna/Cable	1 (back)

Outputs (both models)

Video	No
Analog audio/Headphone	1 (side)
Digital audio	1 (optical) (side)
WiFi	Yes
Ethernet	No

Audio

	LC-43LB371U	LC-50LB371U
Speakers	Number: 2 Watts per channel: 8W	Number: 2 Watts per channel: 8W

Power

	LC-43LB371U	LC-50LB371U
Power consumption	On: 90W Standby: <1W	On: 119W Standby: <1W
Power input	AC 120 V, 60Hz	AC 120 V, 60Hz

Miscellaneous

	LC-43LB371U	LC-50LB371U
OSD languages	English/French	English/French
CEC control	Yes	Yes
Game Mode	Yes	Yes
ENERGY STAR qualified	No	No
Internet connectable	Yes	Yes
TV base screws	Base to TV screen: M4 type (28 mm length) (4 pcs)	Base to TV screen: M6 type (36 mm length) (4 pcs)
V-Chip (version 2.0)	Yes	Yes
Sleep timer	Yes	Yes
Channel labeling	No	No
VESA mount (mm) (Hor. x Ver.)	200 x 200	400 x 200
VESA mount screws	M6	M6

Note

The length of the wall-mount screws vary depending on the wall-mount bracket you purchased. See the instructions that came with the wall-mount bracket for screw lengths.

Legal notices

Copyright

Portions © 2016 Best Buy and Roku, Inc. All rights reserved. ROKU, the ROKU Logo, and "NOW THIS IS TV." are trademarks and/or registered trademarks of Roku, Inc. Material in this User Manual is the property of Best Buy and its subsidiaries, and Roku, Inc. and is protected under US and International copyright and/or other intellectual property laws.

Reproduction or transmission of the materials, in whole or in part, in any manner, electronic, print, or otherwise, without the prior written consent of the Best Buy and Roku, Inc. is a violation of Best Buy and Roku, Inc.'s rights under the aforementioned laws.

No part of this publication may be stored, reproduced, transmitted or distributed, in whole or in part, in any manner, electronic or otherwise, whether or not for a charge or other or no consideration, without the prior written permission of Roku, Inc. and Best Buy.

Requests for permission to store, reproduce, transmit or distribute materials may be made to the following addresses:

Best Buy
7601 Penn Ave South
Richfield, MN 55423 U.S.A.
Roku, Inc.
French (Canada)
12980 Saratoga Ave, Suite D
Saratoga, CA 95070

Best Buy, Roku, Inc. and any and all other Best Buy or Roku, Inc. product names, logos, slogans or marks are registered trademarks of Best Buy and its subsidiaries and Roku, Inc. All other trademarks are the property of their respective holders.

Product name: Sharp Roku TV

Document name: *Sharp Roku TV User Guide*

Document revision: 7.0.4

Publication date: 10 October 2015

Legal statement

Please note—your access and use of streaming content and channels via the Sharp Roku TV are governed by the Sharp Roku TV End User Agreement (see below). By using the Sharp Roku TV you agree to the following disclaimer. For the avoidance of doubt, the content set forth herein shall refer to all content and channels accessible and available on the Sharp Roku TV, including those available via the Roku® streaming platform, as well as broadcast cable.

Due to the various capabilities of the Sharp Roku TV, as well as limitations in the available content available therein, certain features, applications, and services may not be available on all Sharp Roku TVs, or in all territories. Some features on the Sharp Roku TV may also require additional peripheral devices or membership fees that are sold separately. Please visit the Sharp or Roku, Inc. websites for more information on the Sharp Roku TV and content availability. The services and availability of content on the Sharp Roku TV are subject to change from time to time without prior notice.

All content and services accessible through the Sharp Roku TV belong to third parties and are protected by copyright, patent, trademark and/or other intellectual property laws. Such content and services are provided solely for your personal noncommercial use. You may not use any content or services in a manner that has not been authorized by the content owner or service provider. Without limiting the foregoing, you may not modify, copy, republish, upload, post, transmit, translate, sell, create derivative works, exploit, or distribute in any manner or medium any content or services displayed through the Sharp Roku TV.

You expressly acknowledge and agree that your use of the Sharp Roku TV is at your sole risk and that the entire risk as to satisfactory quality, performance and accuracy is with you. The Sharp Roku TV and all third party content and services are provided "as is" without warranty of any kind, either express or implied. Sharp and Roku expressly disclaims all warranties and conditions with respect to the Sharp Roku TV content and services, either express or implied, including but not limited to, warranties of merchantability, of satisfactory quality, fitness for a particular purpose, of accuracy, of quiet enjoyment, and non-infringement of third party rights. Sharp and Roku do not guarantee the accuracy, validity, timeliness, legality, or completeness of any content or service made available through the Sharp Roku TV and does not warrant that the Sharp Roku TV, content or services will meet your requirements, or that operation of the Sharp Roku TV will be uninterrupted or error-free. Under no circumstances, including negligence, shall Sharp be liable, whether in contract or tort, for any direct, indirect, incidental, special or consequential damages, attorney fees, expenses, or any other damages arising out of, or in connection with, any information contained in, or as a result of the use of the device, or any content or service accessed by you or any third party, even if advised of the possibility of such damages.

Third party services may be changed, suspended, removed, terminated or interrupted, or access may be disabled at any time, without notice, and Sharp and Roku makes no representation or warranty that any content or service will remain available for any period of time. Content and services are transmitted by third parties by means of networks and transmission facilities over which Sharp and Roku have no control. Without limiting the generality of this disclaimer, Sharp and Roku expressly disclaims any responsibility or liability for any change, interruption, disabling, removal of or suspension of any content or service made available through the Sharp Roku TV. Sharp, Roku, the content providers, or the service providers may impose limits on the use of or access to certain services or content, in any case and without notice or liability. Any questions or requests for service relating to the content or services made available on the Sharp Roku TV should be submitted to the respective cable content or service provider or as described in the Sharp Roku TV User Guide.

In the event of a conflict between the [Sharp Roku TV End User Agreement and the terms set forth in this Legal Disclaimer, the Sharp Roku TV End User Agreement shall prevail and control in all circumstances.

Roku TV End User License Agreement

IMPORTANT: READ THIS AGREEMENT CAREFULLY IF YOU HAVE ANY INSIGNIA ROKU TV ALSO REVIEW THE IMPORTANT PRODUCT INFORMATION GUIDE BEFORE POWERING UP YOUR INSIGNIA ROKU TV FOR THE FIRST TIME.

Overview

This End User License Agreement ("EULA") between you and Roku, Inc. ("Roku") governs the use of: (a) your television which uses the Roku platform to play digital content over the Internet ("Television"), and (b) any firmware and software that have been pre-installed on the Television and the firmware and software updates Roku provides to you for the Television (collectively, the "Software"). By linking the Television to your account on Roku's website ("Roku Account") or using the Television, you are agreeing to this EULA. If you are a resident of the European Economic Area, by agreeing to this EULA, you expressly agree to waive your right to withdraw.

If you do not agree to this EULA, you do not have the right to use the Television or the Software. If you are within the allowable time period for returns under the applicable return policy, you may return the Television to your seller for a refund, subject to the terms of such return policy. You should perform a factory reset before you return it to erase data that may be stored on the Television. For instructions on how to reset your Television, please visit www.roku.com/support.

In this EULA, "Channel" means an application in the Roku Channel Store; "Content" means movies, television shows, music and other audio and visual materials and entertainment; "Content Provider" means any provider of Content; and "Roku Channel Store" means the storefront of applications provided by Roku via the Television's on-screen menu.

Changes to This EULA

Roku may amend this EULA at any time in its discretion. Such amendments shall be effective immediately upon posting of the amended EULA on Roku's website or via the Television or your Roku Account, whichever occurs first. If you have a Roku Account that is linked to your Television, then in its option, Roku may also notify you of the amended EULA by sending a notice to the last email address you have provided to Roku. You agree to provide accurate and complete information if and when you set up your Roku Account, and you agree to promptly update your account information (including contact information) to keep it accurate and complete. You can do this at any time by signing in to your Roku Account. Following such posting or notice by any of the methods described above, continued use of your Television or Roku Account means you accept and agree to the amended EULA. If you do not agree to the amended EULA, Roku may not be able to provide updates, upgrades or enhancements to your Television, and you may not be able to continue using your Television or Roku Account.

Permitted Use and Restrictions

The Television and the Software are for personal, non-commercial use only. Copying or redistribution of any Content delivered via the Television is strictly prohibited and we may prevent or restrict you from copying or re-distributing any elements of the Software or Content using digital rights management or other technologies. The Television and the Software are for use only in those countries where the manufacturer of your Television has authorized its sale. If you are using the Television and the Software outside of these countries, the rights granted under this EULA do not apply. Some of the Content Providers use technologies to verify your geographic location, and you may not be able to use the Television or the Software to access any Content outside of the country or location authorized by Roku or the Content Provider. Except as expressly provided under this EULA, you do not acquire any intellectual property or other proprietary rights in or to the Television, the Software or the Content, including any rights in patents, inventions, improvements, designs, trademarks, database rights or copyrights, nor do you acquire any rights in any confidential information or trade-secrets. All rights not expressly granted to you in this EULA are reserved by Roku or its applicable licensors. You may not remove, obscure, alter or conceal any trademark, logo, copyright or other proprietary notice in or on any Television, Software or Content.

The Software is proprietary to Roku or its third party licensors and may be used only with the Television. Subject to this EULA and, where appropriate, the applicable third party licenses, you have a non-exclusive, non-transferable license to run the Software and any updated versions provided to you by Roku, only in and as incorporated in the Television. This is a license and not a sale. You may not (a) copy, assign, sublicense, lease, sell or rent the Software, (b) distribute or otherwise transfer the Software except as incorporated in the Television, provided that, you do not retain any copies of the Software and the recipient reads and agrees to this EULA (including all amendments); (c) modify, adapt, translate, or create derivative works of the Software (except only to the extent any of the foregoing restriction is prohibited by applicable law or as may be permitted by

the license terms governing any Separately Licensed Code included with the Software); (d) decompile, disassemble, reverse engineer or otherwise derive source code from the Software, except to the extent such actions cannot be prohibited under applicable law because they are essential to achieve inter-operability of the Software with another software program, and provided that the information obtained by you during such activities is (i) used only to achieve such inter-operability; (ii) not disclosed without Roku's prior written consent; and (iii) not used to create any software that is substantially similar to the Software; (e) defeat, bypass, circumvent or interfere with any security mechanism or access control measures, or (f) have any of the foregoing done for you by a third party. This license does not include the right to receive Software upgrades or updates. Your right to use the Television and the Software will immediately terminate upon your breach of this EULA.

Software Updates

In its sole discretion, ROKU MAY PROVIDE UPDATES TO YOUR TELEVISION VIA the internet, including BUG FIXES AND UPDATES, CHANGES IN THE USER INTERFACE OR HOW YOU ACCESS CONTENT, AND OTHER CHANGES THAT MAY add, ALTER or remove functionalities and features. You acknowledge that these updates: (a) may happen automatically in the background at any time (and that they cannot be disabled by You); AND (b) will require an internet CONNECTION and You may incur additional data charges from the provider of the INTERNET CONNECTION. You understand that these updates are necessary to maintain compatibility with other updates to ROKU'S products or services and may be required for security reasons. By using the TELEVISION, you hereby AGREE to receive such updates.

Separately Licensed Code

Certain software components of the Software are provided under separate third party license terms ("Separately Licensed Code") and your right to use such components is governed by such license terms. Please visit <https://www.roku.com/separatelylicensedcode> for more information.

Voice Search

If downloaded to your phone or mobile device, the Roku mobile app allows you to use your voice to search for content on your Television using voice search. When you choose to use voice search, you agree that Roku and/or a third party vendor contracted by Roku have your consent to record, process and store your voice inputs (e.g., a recording and the interpretation of what was said), and use such voice inputs with other information about your Television (e.g., device identifier) to provide services related to voice search to you, to improve the accuracy and quality of the service, and as described in Roku's Privacy Policy. To learn more about voice search, visit the FAQ pages of Roku's website at www.roku.com/support.

NO WARRANTY FROM ROKU; Limitation of LIABILITY

YOUR warranty with respect to the Television is provided by THE TELEVISION'S MANUFACTURER, and not by Roku. ROKU OFFERS NO WARRANTY TO YOU UNDER THIS EULA. WITHOUT LIMITING THE GENERALITY OF THE FOREGOING DISCLAIMER, TO THE MAXIMUM EXTENT PERMITTED BY APPLICABLE LAW:

- (A) THE SEPARATELY LICENSED CODE AND THE SOFTWARE ARE PROVIDED "AS IS", WITH ALL FAULTS AND WITHOUT WARRANTY OF ANY KIND. ROKU DISCLAIMS ALL OTHER WARRANTIES AND CONDITIONS, INCLUDING THE IMPLIED WARRANTY OF MERCHANTABILITY, SATISFACTORY QUALITY, FITNESS FOR A PARTICULAR PURPOSE AND NON-INFRINGEMENT. ROKU DOES NOT GUARANTEE, REPRESENT, OR WARRANT THAT THE TELEVISION, THE SEPARATELY LICENSED CODE AND THE SOFTWARE WILL BE: (I) SECURE, VIRUS-FREE OR ERROR-FREE, OR (II) FREE FROM ATTACK OR SECURITY INTRUSION.
- (B) IN NO EVENT SHALL ROKU, ITS DIRECTORS, OFFICERS OR EMPLOYEES BE LIABLE TO YOU FOR PERSONAL INJURY OR PROPERTY DAMAGE, OR ANY SPECIAL, INCIDENTAL, EXEMPLARY, PUNITIVE, INDIRECT OR CONSEQUENTIAL DAMAGES OF ANY KIND ARISING OUT OF ANY TELEVISION, THE SEPARATELY LICENSED CODE, THE SOFTWARE, OR YOUR USE THEREOF; AND

- (C) YOU AGREE THAT (I) THE TOTAL CUMULATIVE LIABILITY OF ROKU, ITS DIRECTORS, OFFICERS AND EMPLOYEES UNDER THIS EULA, INCLUDING LIABILITY RELATING TO ALL TELEVISIONS LINKED TO YOUR ROKU ACCOUNT, AND THE SEPARATELY LICENSED CODE AND THE SOFTWARE IN SUCH TELEVISIONS, AND YOUR USE THEREOF, SHALL NOT EXCEED THE AMOUNT SET FORTH IN THE ROKU ACCOUNT TERMS AND CONDITIONS YOU AGREED TO FOR YOUR ROKU ACCOUNT, AND (II) ROKU, ITS DIRECTORS, OFFICERS AND EMPLOYEES SHALL NOT BE LIABLE TO YOU UNDER THIS EULA FOR ANY DIRECT DAMAGES ARISING OUT OF, OR IN CONNECTION WITH THE TELEVISION. THE FOREGOING LIMITATIONS SHALL APPLY EVEN IF THE REMEDY PROVIDED HEREIN FAILS ITS ESSENTIAL PURPOSE AND EVEN IF ROKU, ITS DIRECTORS, OFFICERS OR EMPLOYEES HAVE BEEN ADVISED OF THE POSSIBILITY OF SUCH LIABILITY.

Some jurisdictions do not allow exclusions OF CERTAIN warranties OR LIMITATIONS OF LIABILITY FOR CERTAIN TYPES OF DAMAGES, so SOME OF the ABOVE LIMITATIONS IN THIS SECTION MAY NOT apply to You. NOTHING IN THESE TERMS OF USE SHALL AFFECT ANY NON-WAIVABLE STATUTORY RIGHTS THAT APPLY TO YOU, AND You may also have other rights that vary from jurisdiction to jurisdiction.

Export Controls

You agree not to download any Content or Software, nor otherwise export or re-export any Television or the Software into (or to a national or resident of) Cuba, Iraq, Libya, North Korea, Iran, Syria or any other country as to which the United States or your country has embargoed goods, or to anyone on the U.S. Treasury Department's List of Specially Designated Nationals or the U.S. Commerce Department's Table of Denial Orders or on similar restricted lists published by your government from time to time. By using any Television or the Software, you are representing and warranting that you are not located in, under the control of, or a national or resident of any such country or on any such list.

Choice of Law; Dispute Resolution

- A. If you are a consumer and a resident in any country in the European Economic Area where the sale of the Television is expressly authorized by its manufacturer, this EULA does not apply to you.
- B. In all other cases, including if you are a resident of the United States (and its possessions and territories) or Canada, you agree that this EULA shall be governed by the laws of the State of California without regard to any conflict of laws principles that may provide the application of the law of another jurisdiction; and:
- You and Roku agree to be bound by the procedures set forth below to resolve any and all claims between you and Roku arising out of or relating to any aspect of this EULA, whether based in contract, tort, statute, fraud, misrepresentation or any other legal theory, including but not limited to, claims between you and Roku related to the Television and the Software. Each such claim is referred to individually as "Claim" and collectively as "Claims".
 - YOU AND ROKU AGREE THAT, EXCEPT FOR THE CLAIMS IDENTIFIED IN PARAGRAPH 4 OF THIS SECTION BELOW, ANY AND ALL CLAIMS BETWEEN YOU AND ROKU SHALL BE FINALLY SETTLED BY BINDING ARBITRATION.** The arbitration shall take place in Santa Clara County, California and shall be administered by the American Arbitration Association ("AAA") pursuant to the AAA's then-current rules, including (if applicable) the AAA's Supplementary Procedures for Consumer-Related Disputes. Please be aware there is no judge or jury in arbitration. Arbitration procedures are simpler and more limited than the rules applicable in court, and review of the arbitrator's decision by a court is limited. **YOU AND ROKU FURTHER AGREE THAT EACH OF YOU MAY BRING CLAIMS AGAINST THE OTHER ONLY ON AN INDIVIDUAL BASIS AND NOT AS A PLAINTIFF OR CLASS MEMBER IN ANY PURPORTED CLASS OR REPRESENTATIVE ACTION OR PROCEEDING. THE ARBITRATOR MAY NOT CONSOLIDATE OR JOIN MORE THAN ONE PERSON'S CLAIM AND MAY NOT PRESIDE OVER ANY CONSOLIDATED, REPRESENTATIVE OR CLASS PROCEEDING. ALSO, THE ARBITRATOR MAY AWARD RELIEF (INCLUDING MONETARY, INJUNCTIVE OR DECLARATORY RELIEF) ONLY ON AN INDIVIDUAL BASIS**

AND MAY NOT AWARD ANY FORM OF CONSOLIDATED, REPRESENTATIVE OR CLASS-WIDE RELIEF.

Notwithstanding any provision in these terms to the contrary, if the class-action waiver in this provision is deemed invalid or unenforceable, or if an arbitration is allowed to proceed on a class basis, then neither you nor Roku are entitled to arbitrate the Claims. This arbitration provision is subject to the Federal Arbitration Act. The arbitrator's award shall be binding on you and Roku, and may be entered in any court of competent jurisdiction.

- Information on AAA and how arbitration is initiated can be found at www.adr.org or by calling 800-778-7879. For Claims between You and Roku of \$75,000 or less, you will be responsible for the initial arbitration filing fee, up to the amount of the initial filing fee if you were to initiate a lawsuit against Roku based on such Claims in court. If the arbitrator finds such Claims to be non-frivolous, Roku will pay any difference in such filing fees? plus the arbitrator fees. For Claims between You and Roku in excess of \$75,000, if you are able to demonstrate that the costs of arbitration will be prohibitive as compared to the costs of litigation, Roku will pay as much of your actual filing fees and the arbitrator fees for the arbitration as the arbitrator deems necessary to prevent the arbitration from being cost-prohibitive as compared to the cost of litigation.
- This agreement to arbitrate does not apply to any Claim (a) in which a party is attempting to protect its intellectual property rights (such as its patent, copyright, trademark, trade secret, or moral rights, but not including its privacy or publicity rights), or (b) that may be brought in small-claims court.
- If the agreement to arbitrate in this provision is found to be invalid, unenforceable or inapplicable to a given Claim between You and Roku, then any and all proceedings to resolve such Claim must be brought exclusively in a federal court of competent jurisdiction in the Northern District of California or in a state court in Santa Clara County, California. You hereby irrevocably consent to the exclusive jurisdiction and venue of such courts.
- 30-Day Right to Opt Out:** You have the right to opt out of this agreement to arbitrate by sending a written notice of your decision to opt out to the following address: Legal Department, Roku, Inc., 12980 Saratoga Avenue, Saratoga, California 95070, USA; provided that, such notice must be postmarked on or before the 30th day after the first to occur of the following events if you do not already have a Roku Account: (a) the date of purchase of Your Television, or (b) the date you create your Roku Account. If you have an existing Roku Account, all devices you choose to link to your Roku Account, and all services provided by Roku which are accessed using these devices, will be subject to this agreement to arbitrate. Your notice should include your full name, your current postal address, telephone number and email address, the product name and serial number for Your Television, and a copy of the original proof of purchase for your Television. If you timely send a notice in compliance with this paragraph 6, the agreement to arbitrate will not apply to either you or Roku. If you do not timely send this notice, then you agree to be bound by this agreement to arbitrate.
- Notwithstanding any provision in this Agreement to the contrary, you agree that, if Roku seeks to delete or materially modify the agreement to arbitrate described herein, any such deletion or modification will not apply to any individual Claim of which you have notified Roku prior to such modification.

Miscellaneous

Roku may transfer its rights and obligations under this EULA to another organization. You may only transfer your rights or your obligations under this EULA to another person if Roku agrees in writing. This EULA is between you and Roku. No other person shall have any rights to enforce these terms. Each of the paragraphs of this EULA operates separately. If any court or relevant authority decides that any of them are unlawful, the remaining paragraphs will remain in full force and effect. If Roku fails to insist that you perform any of your obligations under this EULA, or if Roku does not enforce its rights against you, or if Roku delays in doing so, that will not mean that Roku has waived its rights against you, or that you do not have to comply with those obligations. If Roku does waive a default by you, Roku will only do so in writing, but that will not mean that Roku will automatically waive any later default by you.

Contact Information

If you wish to contact Roku, please send your correspondence by mail to

Roku, Inc.

12980 Saratoga Avenue, Suite D

Saratoga, CA 95070

or by email to www.customerservice@roku.com.

Last Updated: October 20, 2015

FCC Statement

Note: This equipment has been tested and found to comply with the limits for a class B digital Device, pursuant to part 15 of the FCC Rules. These limits are designed to provide reasonable protection against harmful interference in a residential installation. This equipment generates, uses and can radiate radio frequency energy and, if not installed and used in accordance with the instructions, may cause harmful interference to radio Communications. However, there is no guarantee that interference will not occur in a particular installation. If this equipment does cause harmful interference to radio or television reception, which can be determined by turning the equipment off and on, the user is encouraged to try to correct the interference by one or more of the following measures:

- Reorient or relocate the receiving antenna.
- Increase the separation between the equipment and the receiver.
- Connect the equipment into an outlet on a circuit different from that to which the receiver is connected.
- Consult the dealer or an experienced radio/TV technician for help.

Warning

Changes or modifications not expressly approved by the party responsible for compliance could void the user's authority to operate the equipment.

Cables

Connections to this device must be made with shielded cables with metallic RF/EMI connector hoods to maintain compliance with FCC Rules and Regulations.

Macrovision statement

This product incorporates copyright protection technology that is protected by U.S. patents and other intellectual property rights. Use of this copyright protection technology must be authorized by Macrovision, and is intended for home and other limited viewing uses only unless otherwise authorized by Macrovision. Reverse engineering or disassembly is prohibited.

U.S. Patent Nos. 5,583,936; 6,836,549; 5,315,448; 6,381,747; 6,501,842; and 7,050,698.

Dolby License Notice and Trademark Acknowledgement



Manufactured under license from Dolby Laboratories. Dolby and the double-D symbol are trademarks of Dolby Laboratories.

HDMI®



The terms HDMI and HDMI High-Definition Multimedia Interface, and the HDMI Logo are trademarks or registered trademarks of HDMI Licensing LLC in the United States and other countries.

Roku®



Roku and the Roku logo are registered trademarks of Roku, Inc. in the United States and other countries.

SHARP • Roku TV

One-year limited warranty - Sharp Televisions

LC-43LB371U/LC-50LB371U 43"/50" 1080p, 60Hz, LED Sharp Roku TV

Definitions:

Best Buy ("Warrantor") warrants to you, the original purchaser of this new Sharp-branded television ("Product"), that the Product shall be free of defects in the original manufacturer of the material or workmanship for a period of one (1) year from the date of your purchase of the Product ("Warranty Period"). For this warranty to apply, your Product must be purchased in the United States or Canada from a Best Buy or Future Shop authorized dealer of Sharp brand products only that are packaged with this warranty statement.

How long does the coverage last?

The Warranty Period lasts for 1 year (365 days) from the date you purchased the Product. Your purchase date is printed on the receipt you received with the Product.

What does this warranty cover?

During the Warranty Period, if the original manufacture of the material or workmanship of the Product is determined to be defective by an authorized Warrantor repair center or store personnel, Warrantor will (at its sole option): (1) repair the Product with new or rebuilt parts; or (2) replace the Product at no charge with new or rebuilt comparable products or parts. Products and parts replaced under this warranty become the property of Warrantor and are not returned to you. If service of Products or parts are required after the Warranty Period expires, you must pay all labor and parts charges. This warranty lasts as long as you own your Sharp Product during the Warranty Period. Warranty coverage terminates if you sell or otherwise transfer the Product.

How to obtain warranty service?

If you purchased the Product at a Best Buy or Future Shop retail store location and your television Product has a screen size of less than 42 inches, please take your original receipt and the Product to any Best Buy store. Make sure that you place the Product in its original packaging or packaging that provides the same amount of protection as the original packaging. If you purchased the Product from a Best Buy or Future Shop online web site, mail your original receipt and the Product to the address listed on the web site. Make sure that you put the Product in its original packaging or packaging that provides the same amount of protection as the original packaging.

To obtain in-home warranty service for a television with a screen 42 inches or larger, in the United States call 1-888-BESTBUY, Canada call 1-866-BESTBUY for Future Shop call 1-800-663-2275. Call agents will diagnose and correct the issue over the phone or will have an Sharp-approved repair technician dispatched to your home.

Where is the warranty valid?

This warranty is valid only in the United States and Canada at Best Buy branded retail stores or websites to the original purchaser of the product in the county where the original purchase was made.

What does the warranty not cover?

This warranty does not cover:

- Customer instruction/education
- Installation
- Set up adjustments
- Cosmetic damage
- Damage due to acts of God, such as power surges
- Accident(s)
- Misuse, unintentional or intentional
- Abuse, unintentional or intentional
- Negligence
- Commercial purposes/use, including but not limited to use in a place of business or in communal areas of a multiple dwelling condominium or apartment complex, or otherwise used in a place of other than a private home.
- Modification of any part of the Product, including the antenna
- Damage due to incorrect operation or maintenance
- Connection to an incorrect voltage or power supply
- Outages, static or other problems with over-the-air reception of the television broadcast signals.
- Attempted repair by any person not authorized by Warrantor to service the Product

- Products sold "as is" or "with all faults"
- Consumables, including but not limited to batteries (i.e. AA, AAA, C etc.)
- Products where the factory applied serial number has been altered or removed
- Loss or Theft of this product or any part of the product
- Failures or Damage caused by any contact including but not limited to liquids, gels or pastes.
- Up to three (3) pixel failures (dots that are dark or incorrectly illuminated) grouped in an area smaller than one tenth (1/10) of the display size or up to five (5) pixel failures throughout the display. (Pixel based displays may contain a limited number of pixels that may not function normally.)
- Problems with delay in motion or action of video images while playing first-person style video games.

REPAIR REPLACEMENT AS PROVIDED UNDER THIS WARRANTY IS YOUR EXCLUSIVE REMEDY FOR BREACH OF WARRANTY. WARRANTOR SHALL NOT BE LIABLE FOR ANY INCIDENTAL OR CONSEQUENTIAL DAMAGES FOR THE BREACH OF ANY EXPRESS OR IMPLIED WARRANTY ON THIS PRODUCT, INCLUDING, BUT NOT LIMITED TO, LOST DATA, LOSS OF USE OF YOUR PRODUCT, LOST BUSINESS OR LOST PROFITS. WARRANTOR MAKES NO OTHER EXPRESS WARRANTIES WITH RESPECT TO THE PRODUCT, ALL EXPRESS AND IMPLIED WARRANTIES OF THE PRODUCT, INCLUDING, BUT NOT LIMITED TO, ANY IMPLIED WARRANTIES OF AND CONDITIONS OF MERCHANTABILITY AND FITNESS FOR A PARTICULAR PURPOSE, ARE LIMITED IN DURATION TO THE WARRANTY PERIOD SET FORTH ABOVE AND NO WARRANTIES, WHETHER EXPRESS OR IMPLIED, WILL APPLY AFTER THE WARRANTY PERIOD. SOME STATES, PROVINCES AND JURISDICTIONS DO NOT ALLOW LIMITATIONS ON HOW LONG AN IMPLIED WARRANTY LASTS, SO THE ABOVE LIMITATION MAY NOT APPLY TO YOU. THIS WARRANTY GIVES YOU SPECIFIC LEGAL RIGHTS, AND YOU MAY ALSO HAVE OTHER RIGHTS, WHICH VARY FROM STATE TO STATE OR PROVINCE TO PROVINCE.

Product information:

For the U.S., go to: <http://www.sharpusa.com/manuals/hd.aspx>

For Canada (English), go to:

<http://www.sharp.ca/en-CA/CustomerSupport/Support/ProductDownloads.aspx>

For Canada (French), go to:

<http://www.sharp.ca/fr-CA/CustomerSupport/Support/ProductDownloads.aspx>

Product support (855) 544-2030

This product is manufactured for Best Buy China Ltd, as trustee for Best Buy China, and distributed and warranted by Best Buy Purchasing, LLC (7601 Penn Avenue South, Richfield, Minnesota, U.S.A. 55423-3645) under brand license by SHARP Corporation.

©2016 Best Buy China LTD. All rights reserved.

SHARP is a registered trademark of Sharp Corporation; used under license by SHARP Corporation. All other trademarks are property of their respective owners.

SHARP • Roku TV

Product information:

For the U.S., go to:

<http://www.sharpusa.com/manuals/hd.aspx>

For Canada (English), go to:

<http://www.sharp.ca/en-CA/CustomerSupport/Support/ProductDownloads.aspx>

For Canada (French), go to:

<http://www.sharp.ca/fr-CA/CustomerSupport/Support/ProductDownloads.aspx>

Product support (855) 544-2030

This product is manufactured for Best Buy China Ltd, as trustee for Best Buy China, and distributed and warranted by Best Buy Purchasing, LLC (7601 Penn Avenue South, Richfield, Minnesota, U.S.A. 55423-3645) under brand license by SHARP Corporation.

©2016 Best Buy China LTD. All rights reserved.

SHARP is a registered trademark of Sharp Corporation; used under license by SHARP Corporation.

All other trademarks are property of their respective owners.

V4 ENGLISH
15-0896